

Current Status of LAMPS TPC

이효상, 이청수, 김영진

2021.01.27

LAMPS TPC

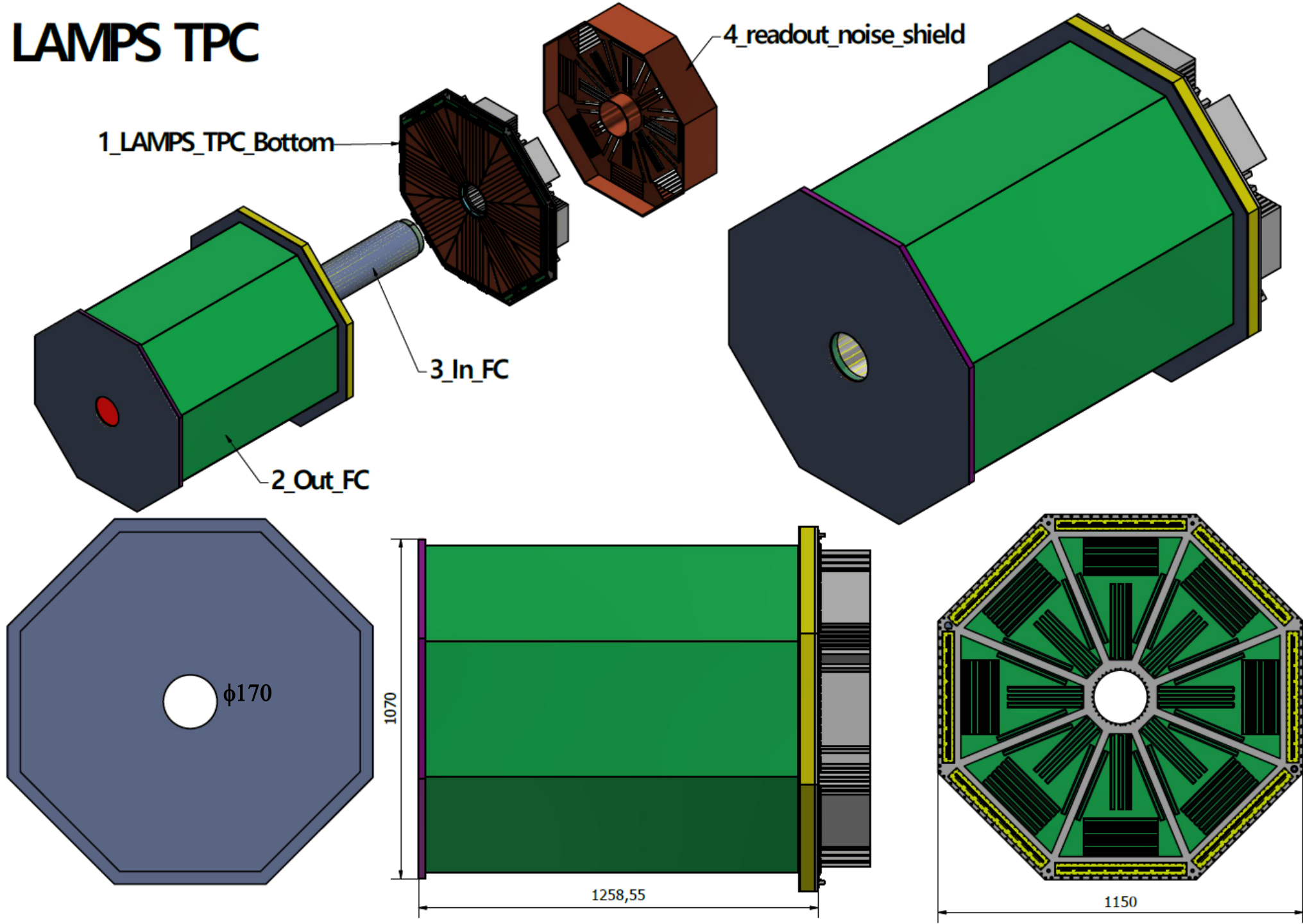

Readout

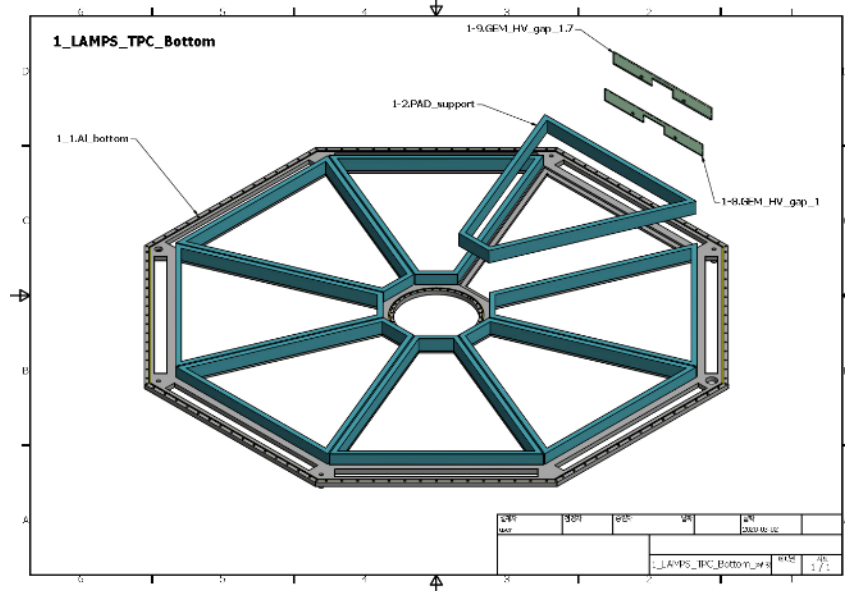

Total # of channel
2698ch x 8section = 21,584ch

11 AsAd boards / 1section
-> total 88 AsAd boards
-> 22 CoBo boards with 3 MicroTCA

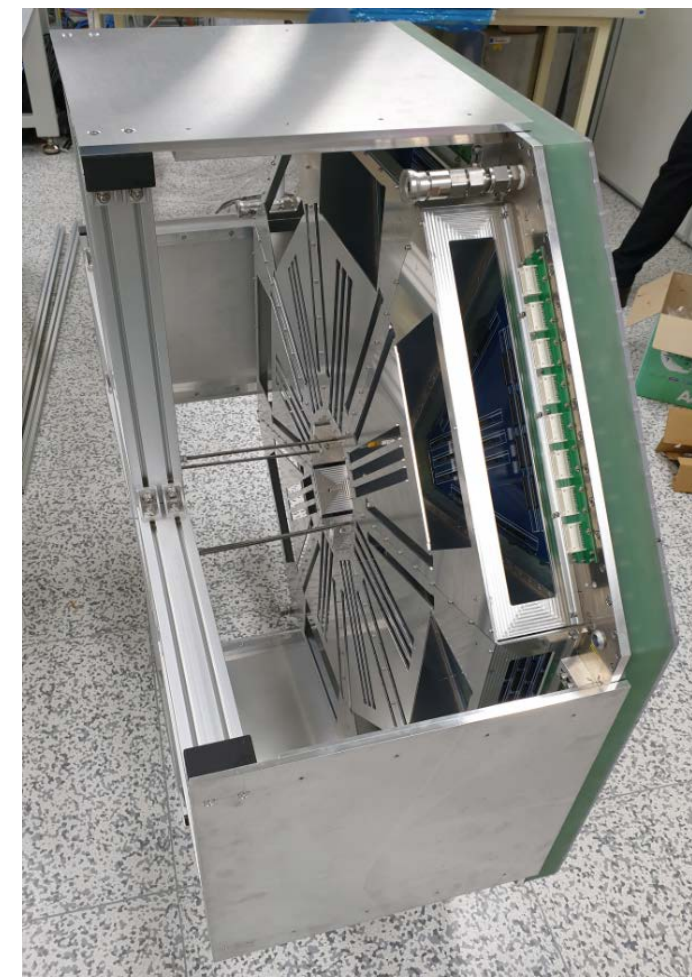
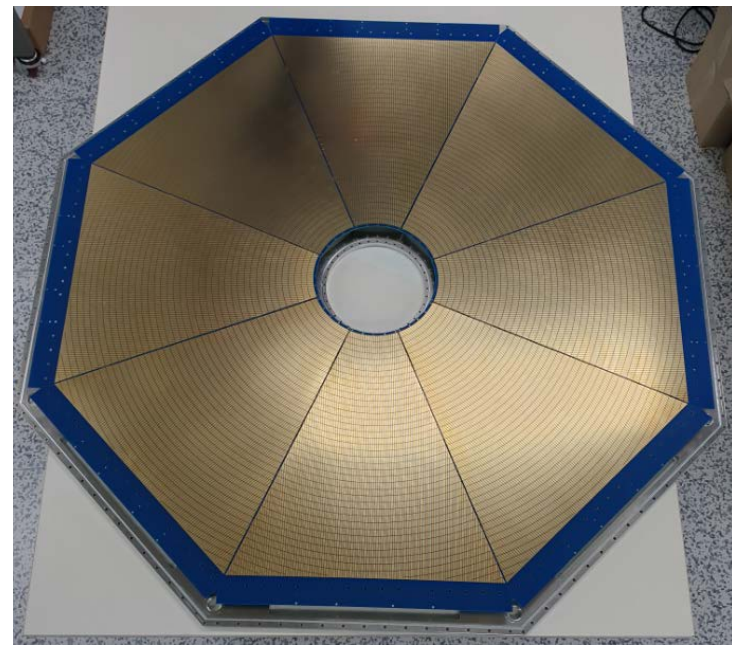

Outer FC

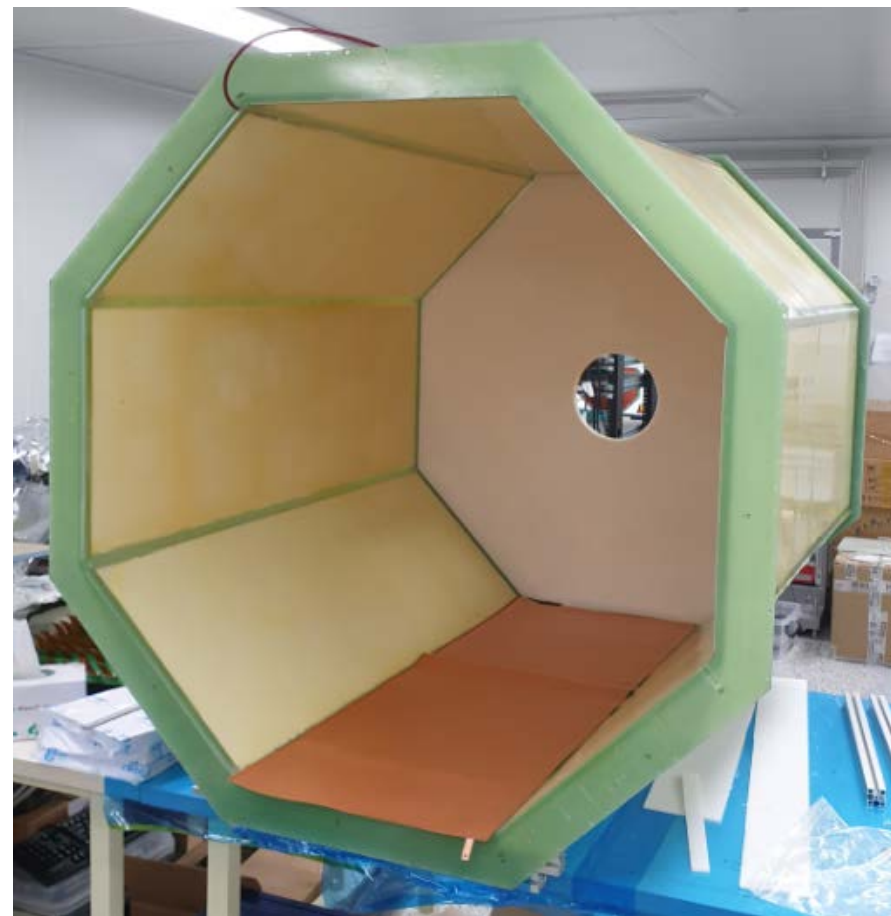
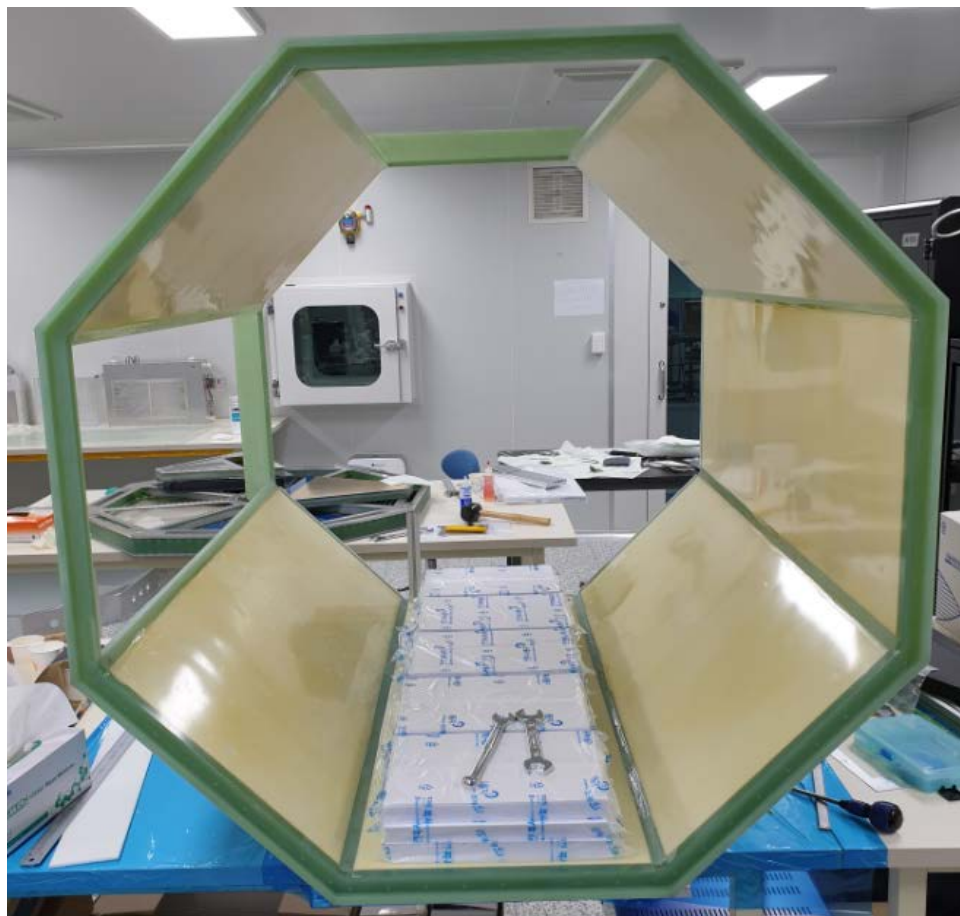
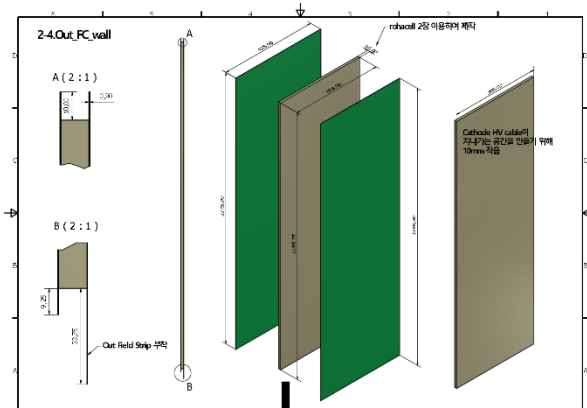
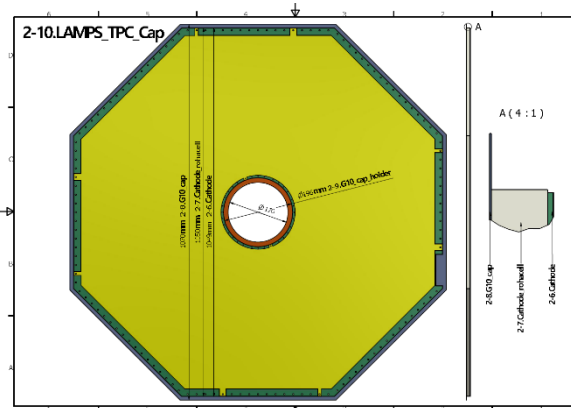
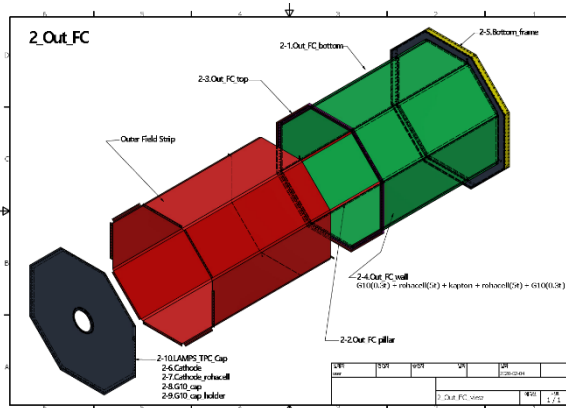
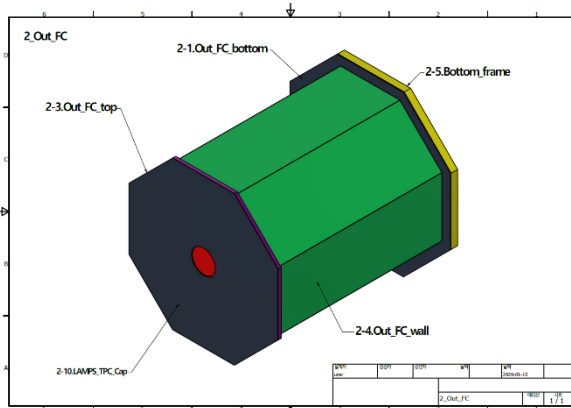

**G10 sheet (0.3mm)
+ Rohacell (5 mm)
+ Kapton (125 μm)
+ Rohacell (5 mm)
+ G10 sheet (0.3mm)**

Inner FC

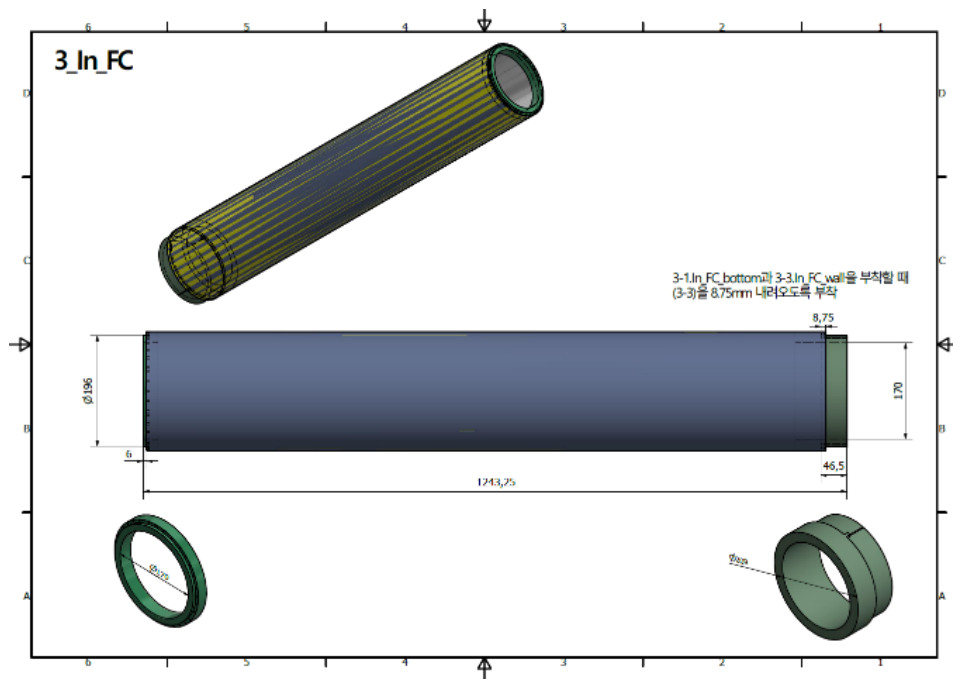

Al-Kapton (25 μm) + G10 sheet (0.3 mm)

Assembly

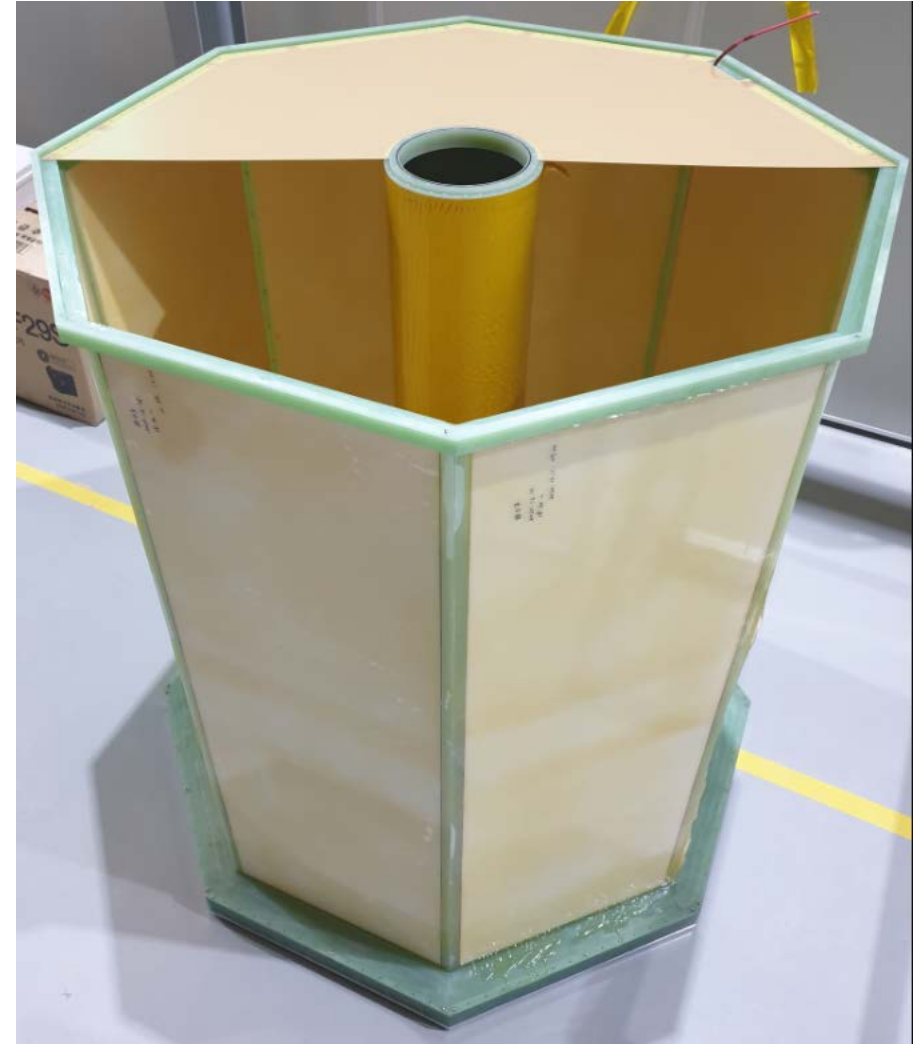
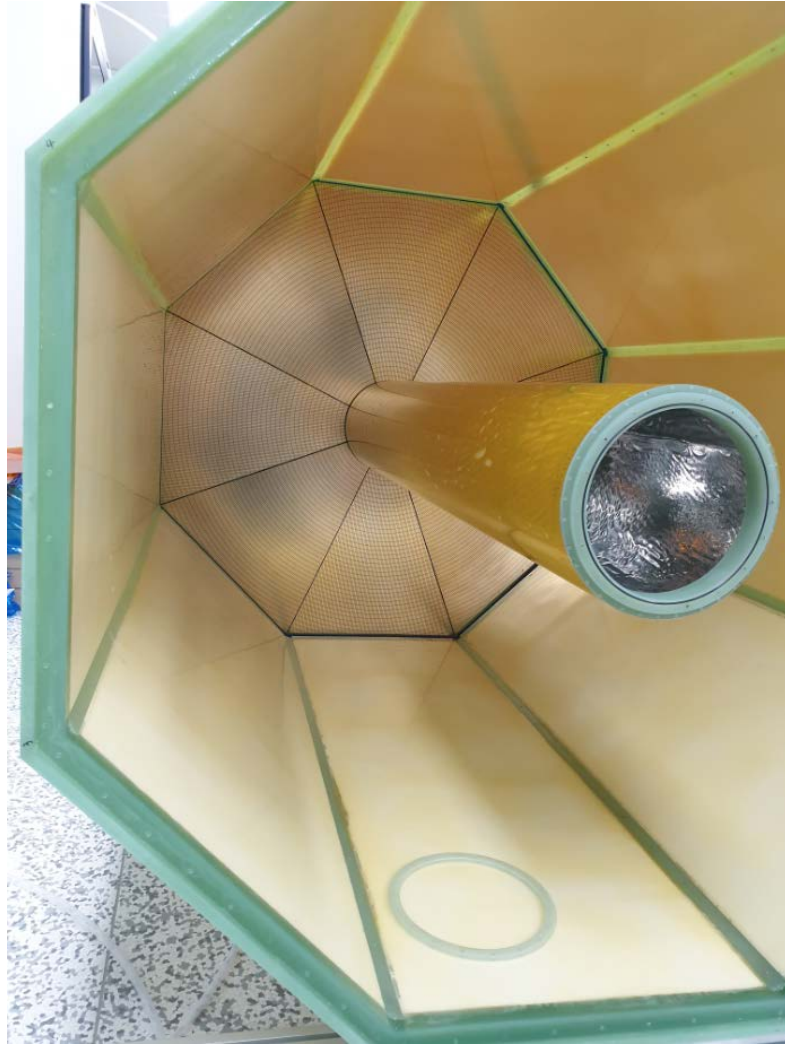
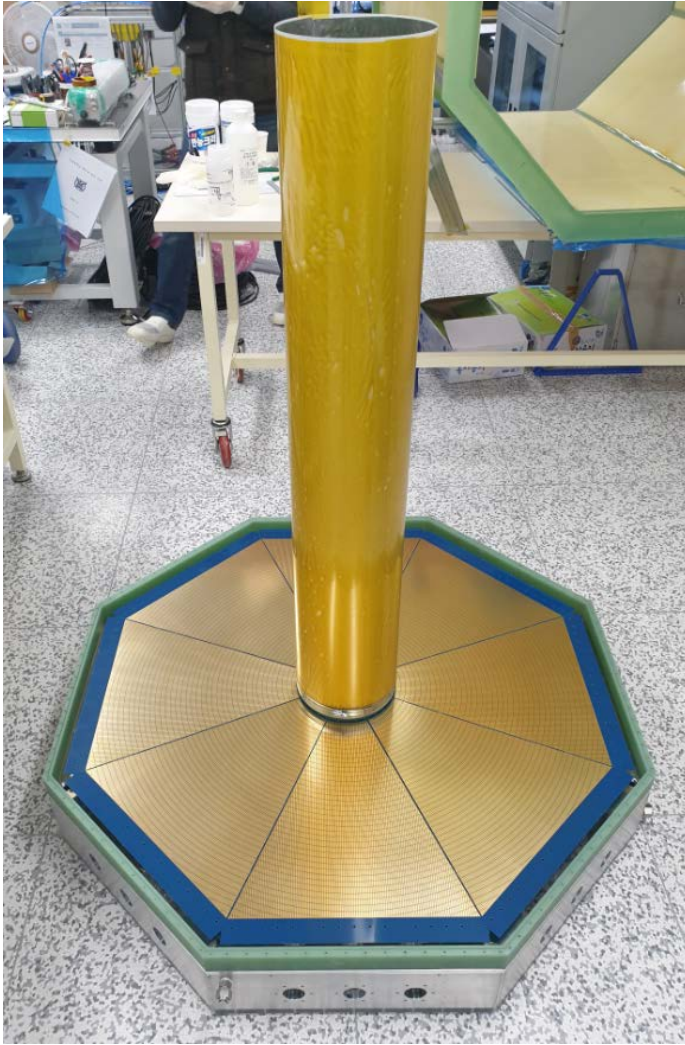

Assembly

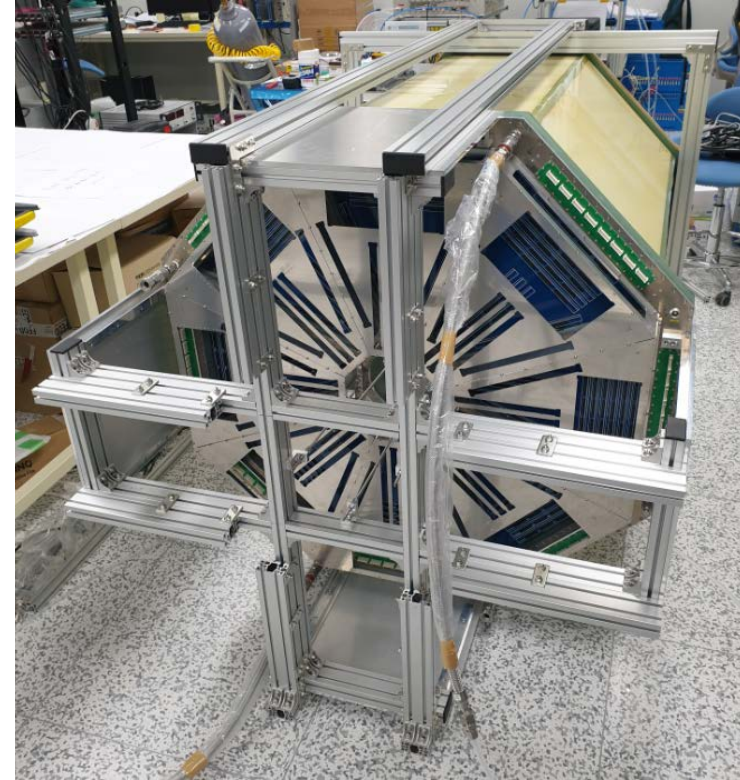
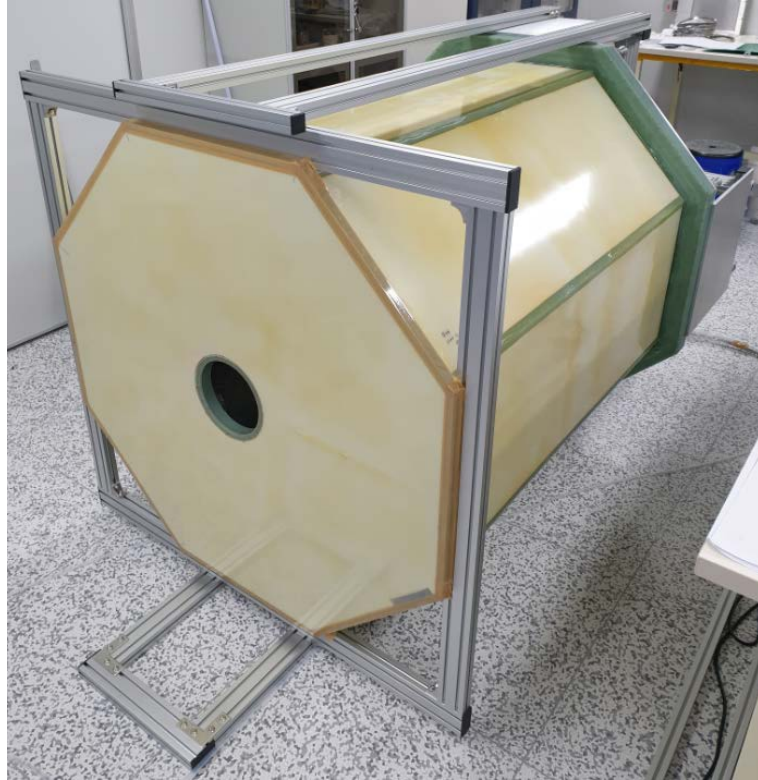

Field Strip

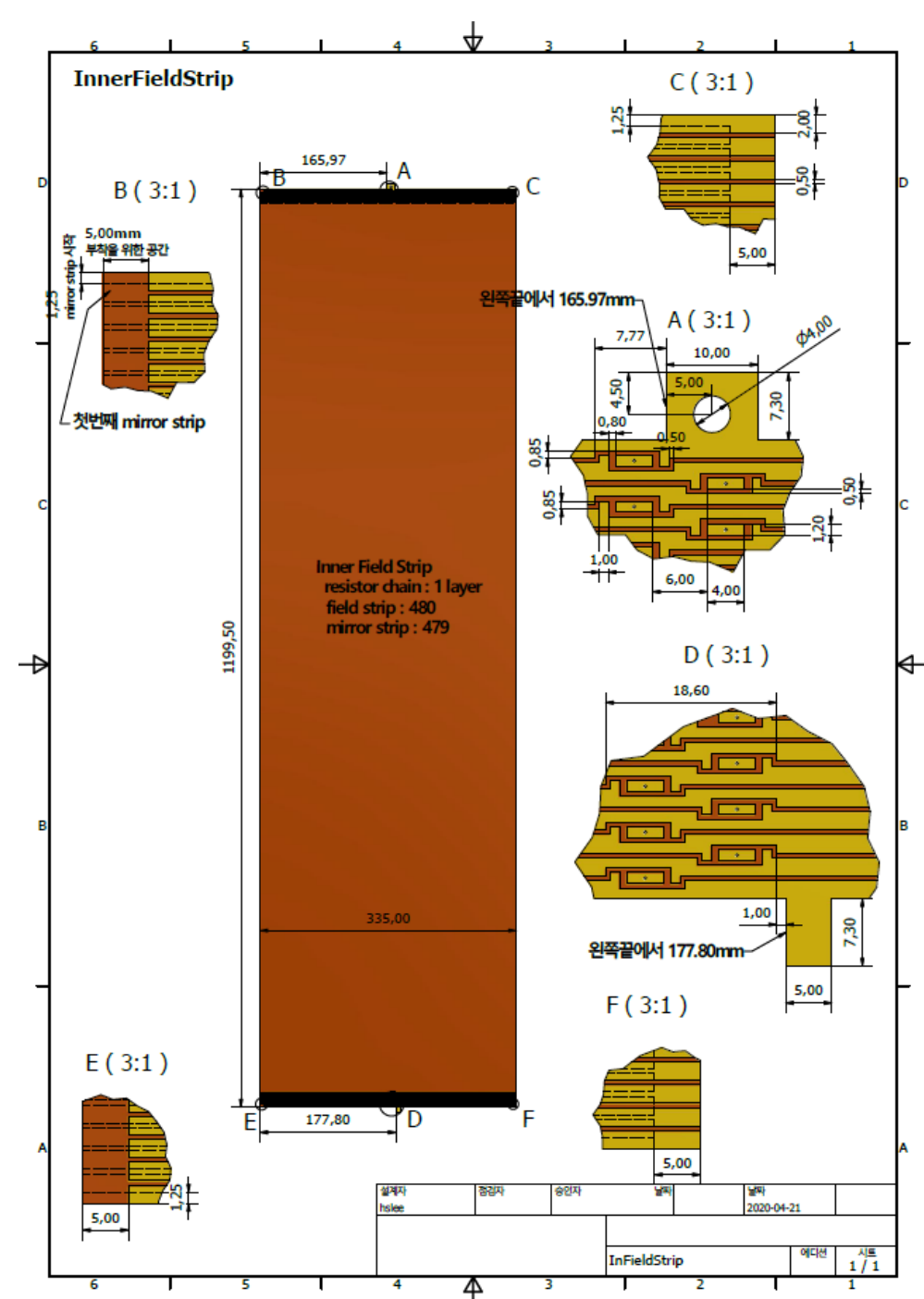
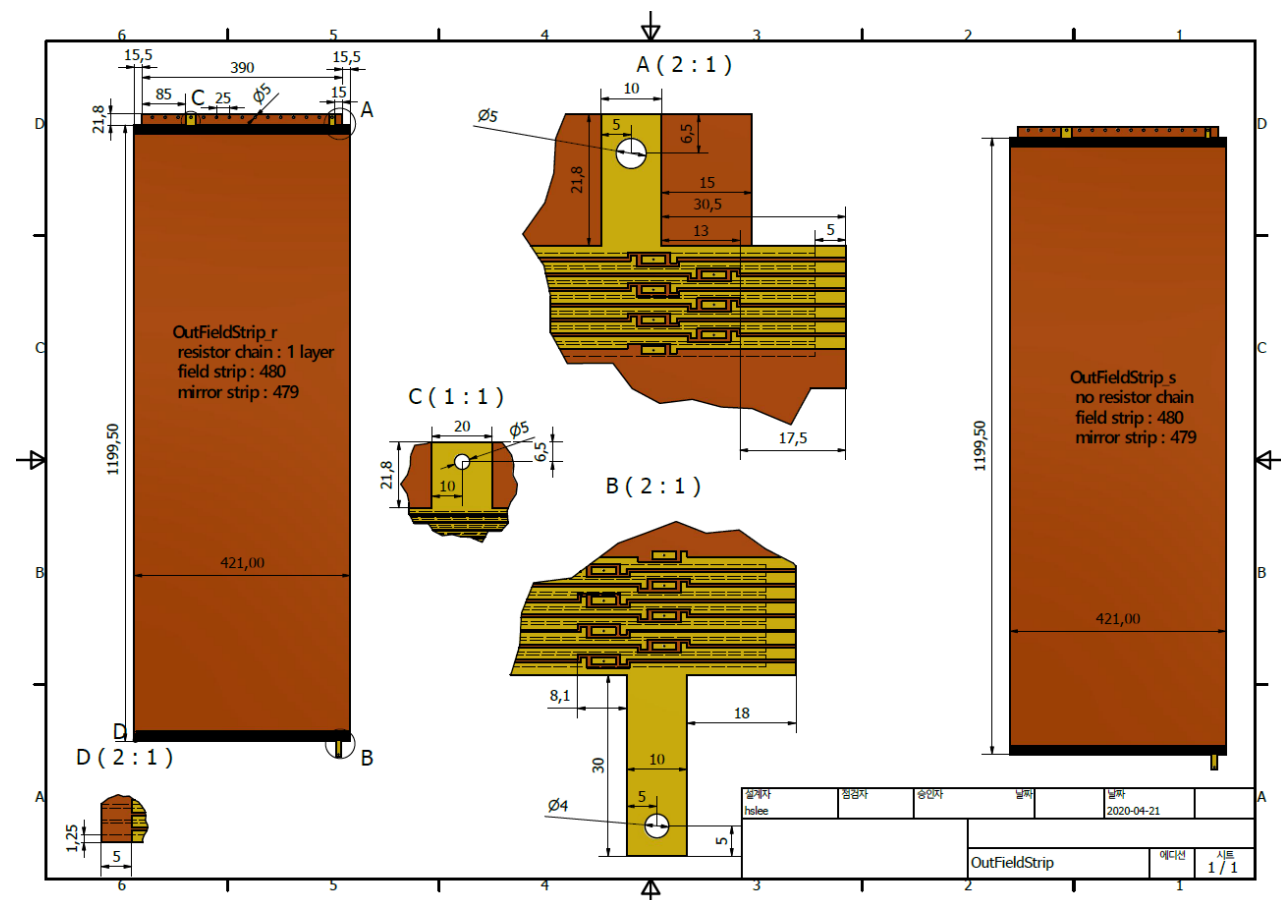
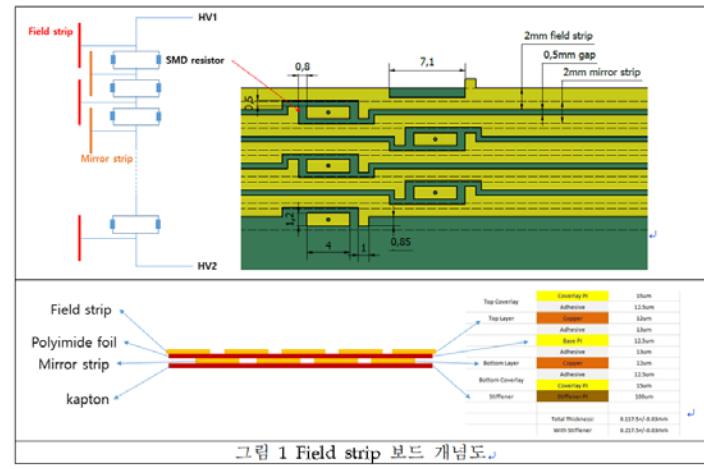

Field Strip

Inner FieldStrip

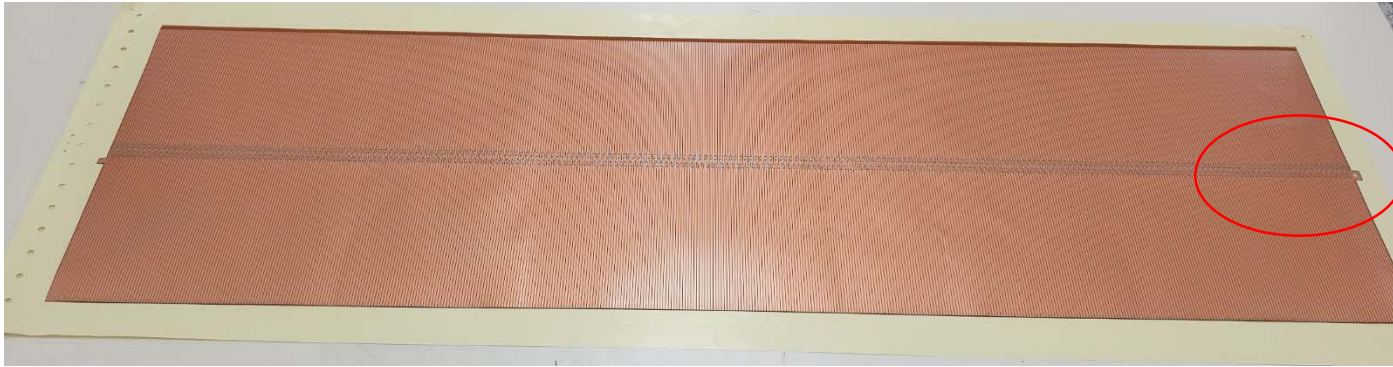

Outer FieldStrip
w/ SMD



Outer FieldStrip
w/o SMD

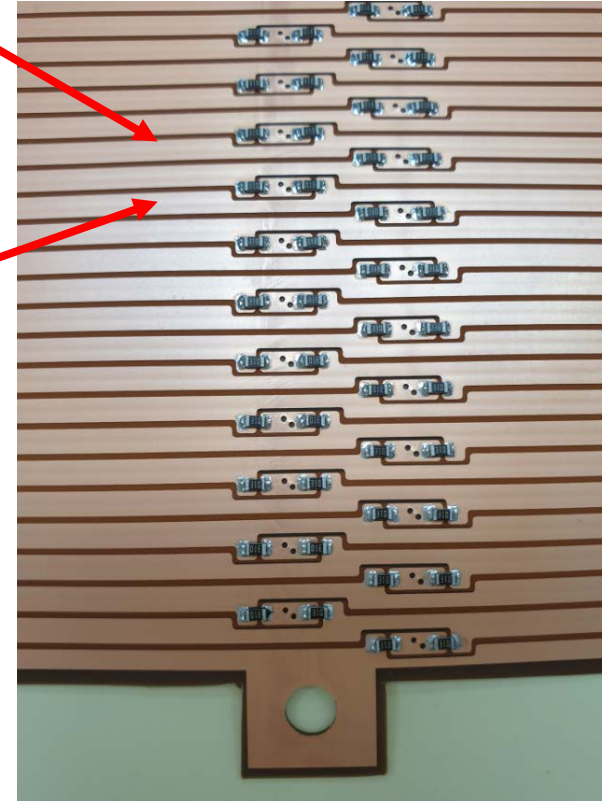

Field Strip

Inner FieldStrip

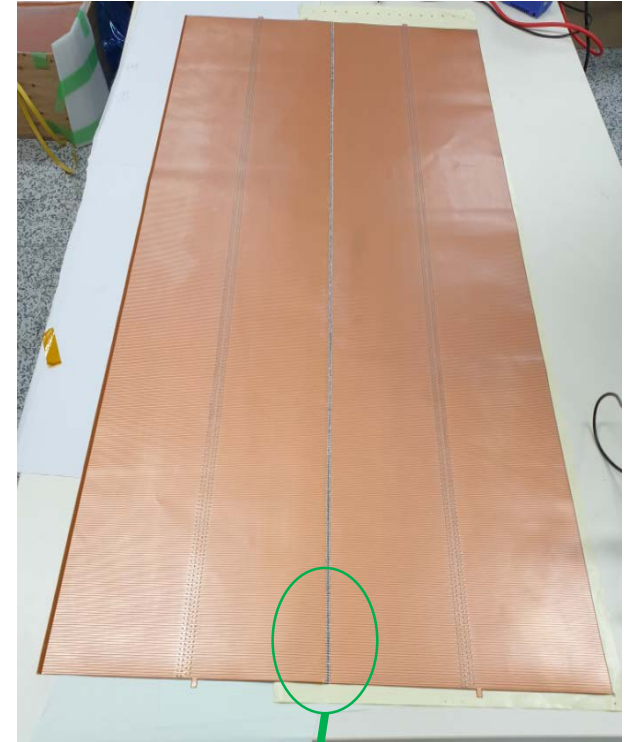

Outer FieldStrip

