

Black : $\pi^+(0)$ $\pi^-(1)$

Pink : Gamma

Red : π^0

Green : Charged lepton

Blue : Neutrino

h1

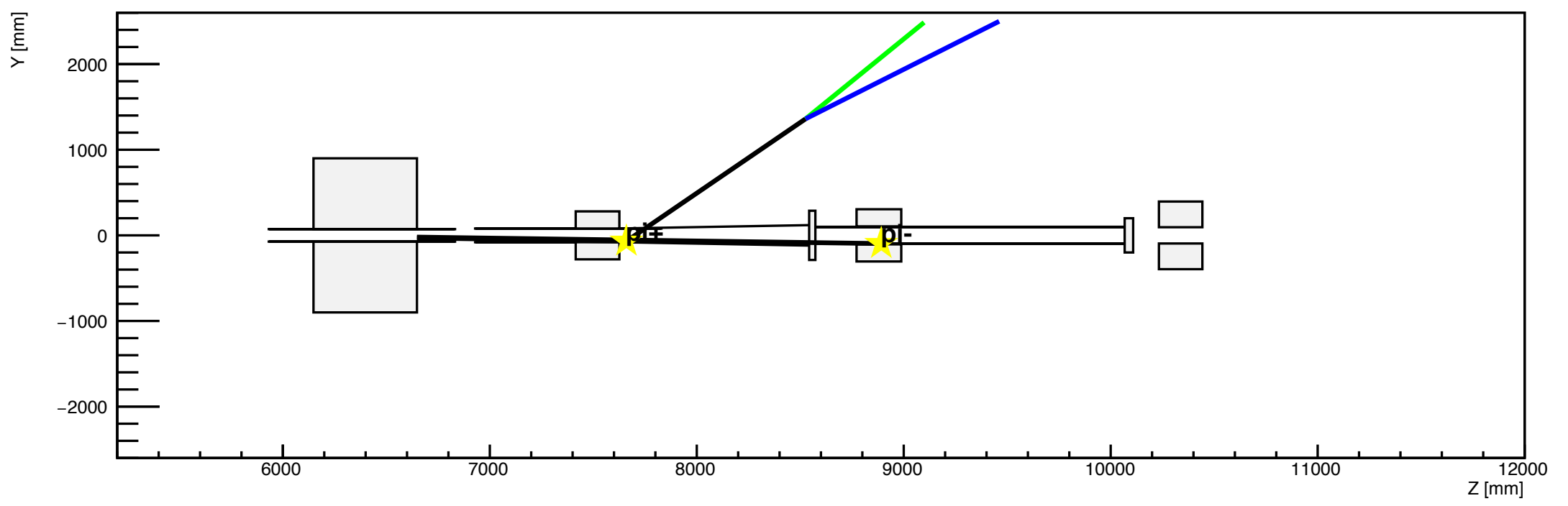

h2

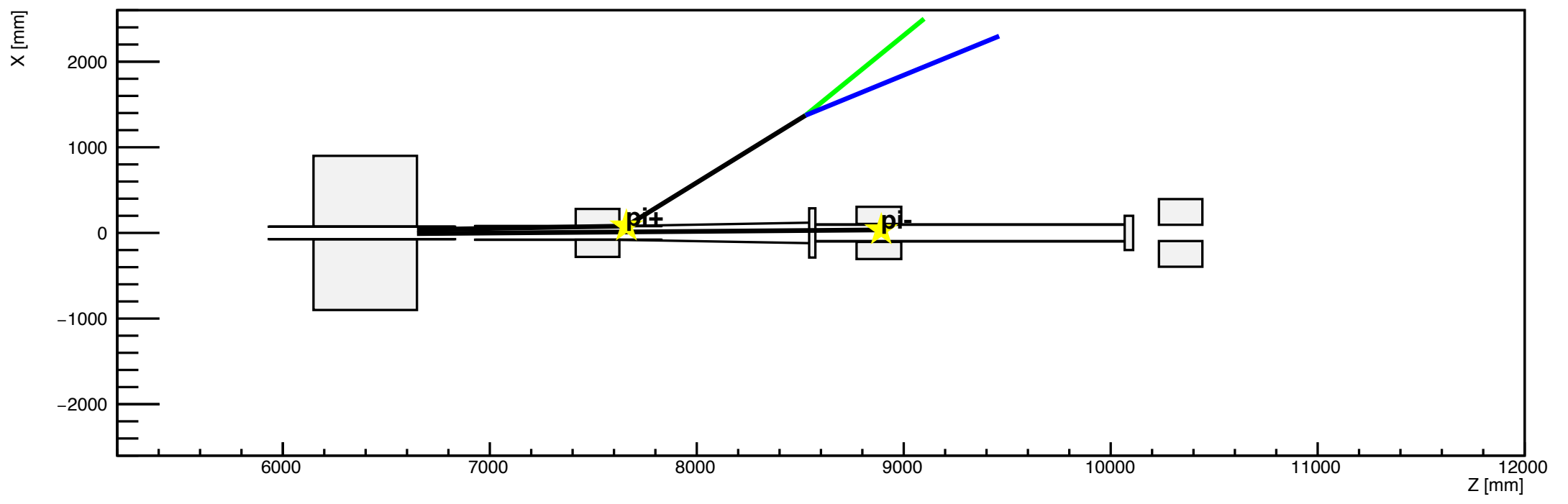

h1

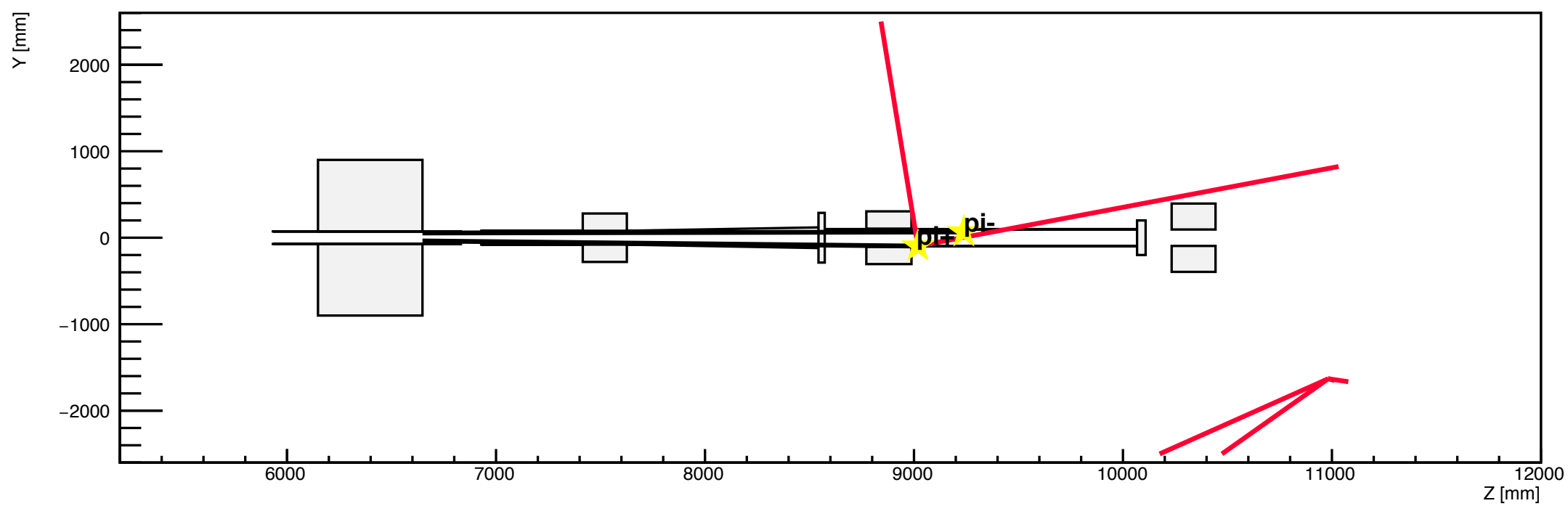

h2

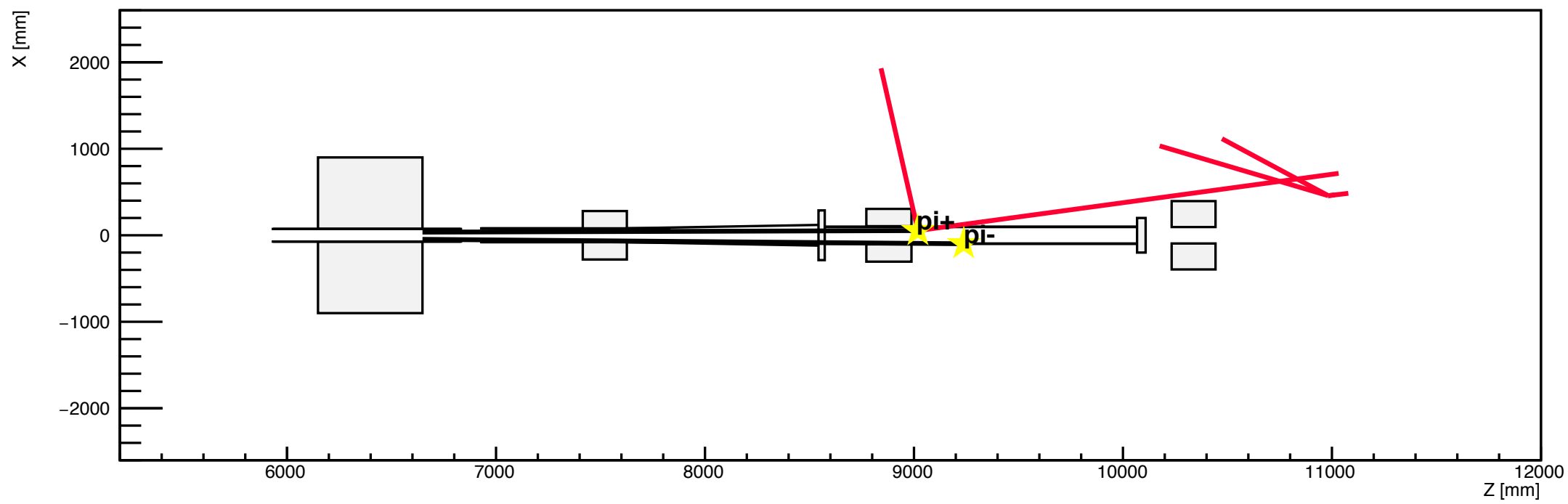

h1

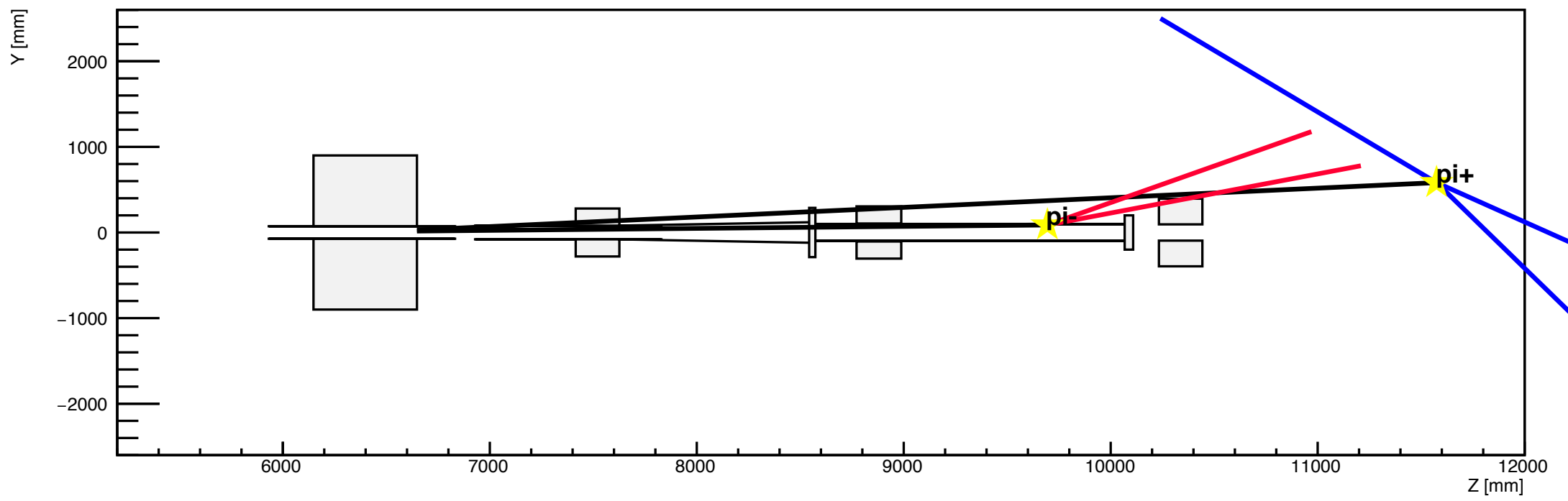

h2

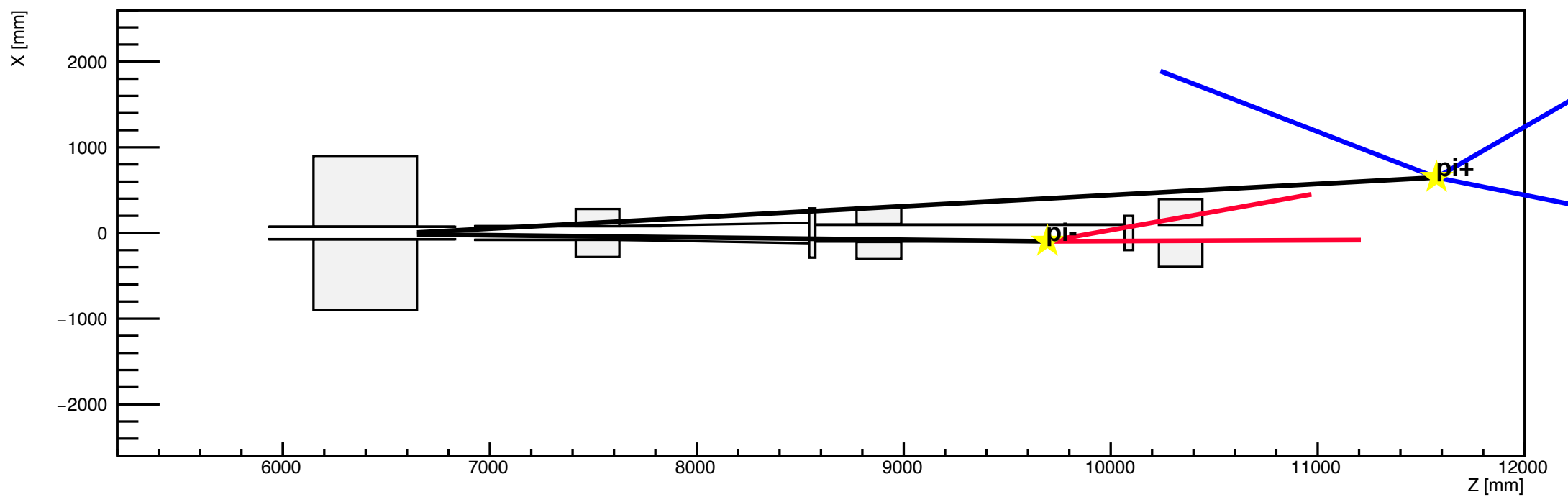

h1

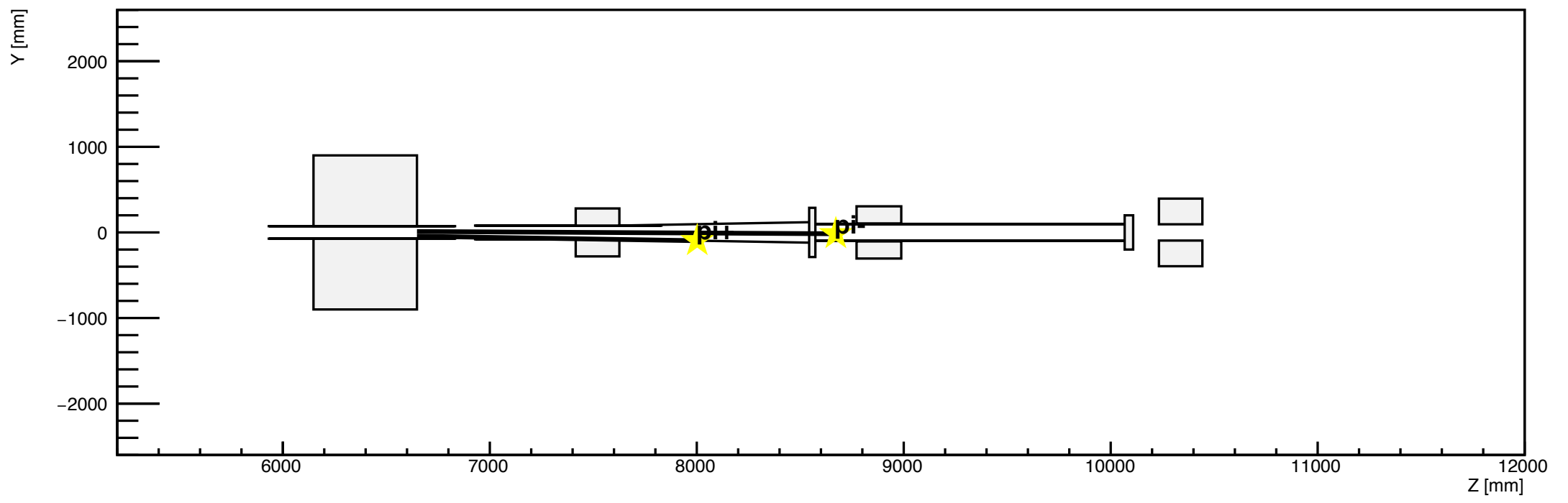

h2

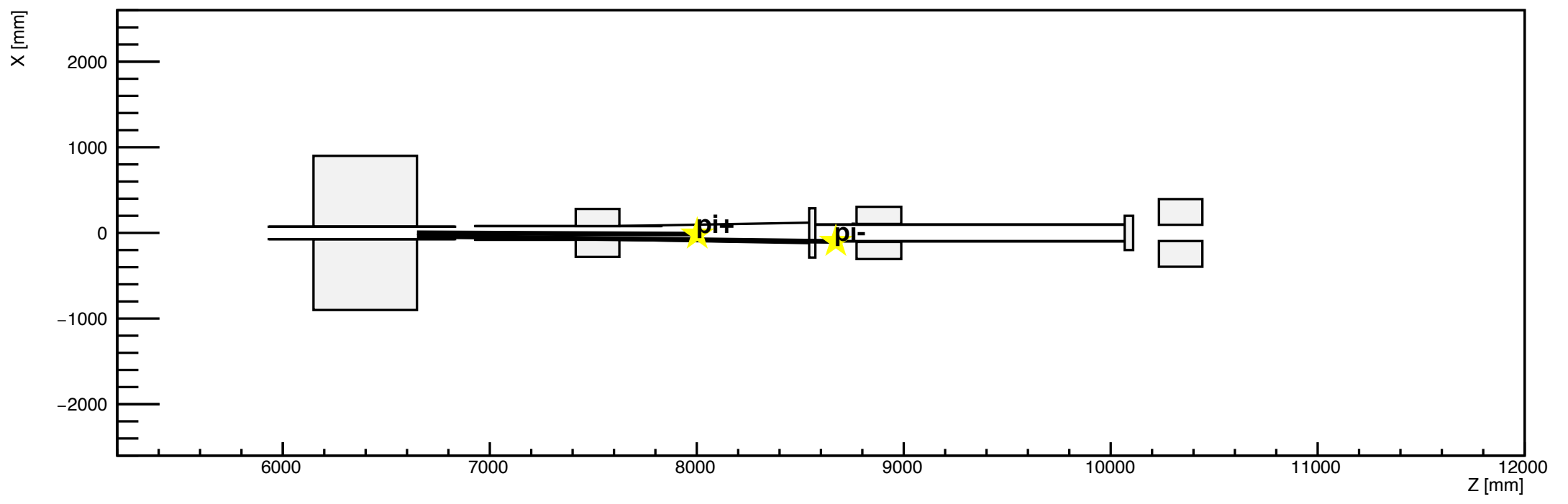

h1

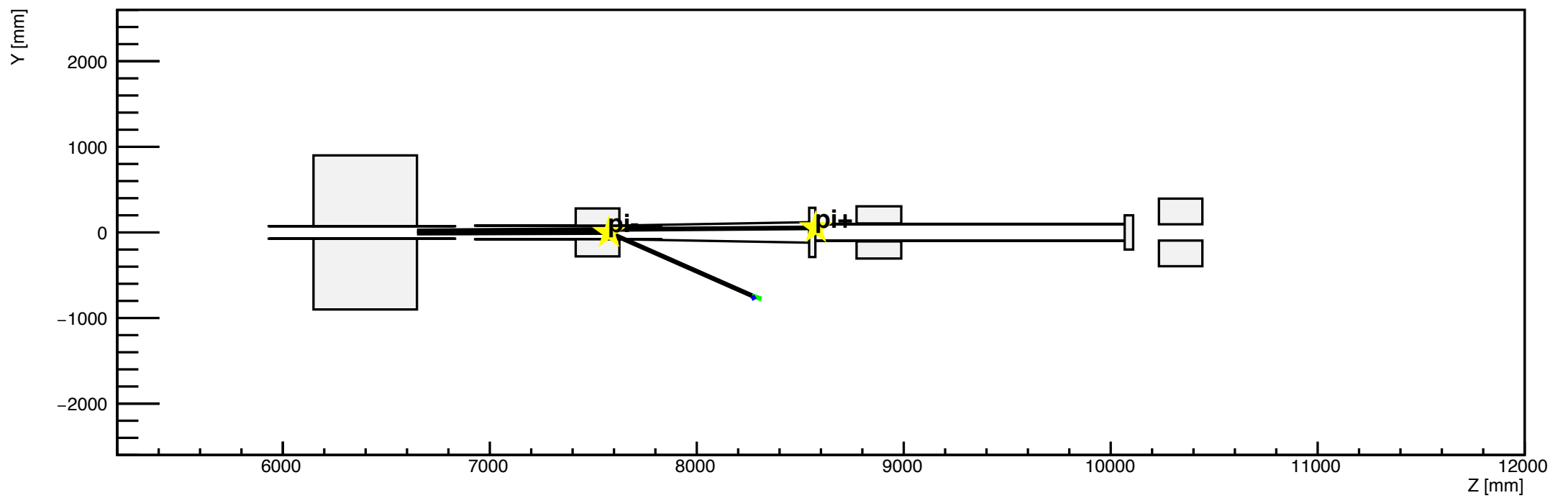

h2

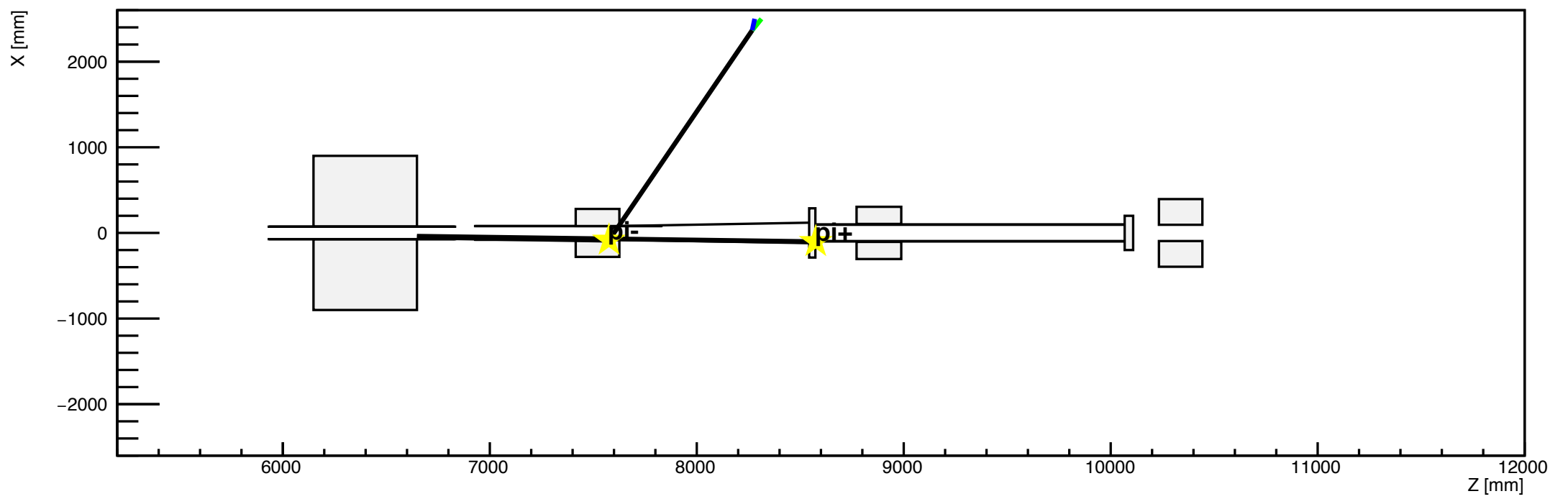

h1

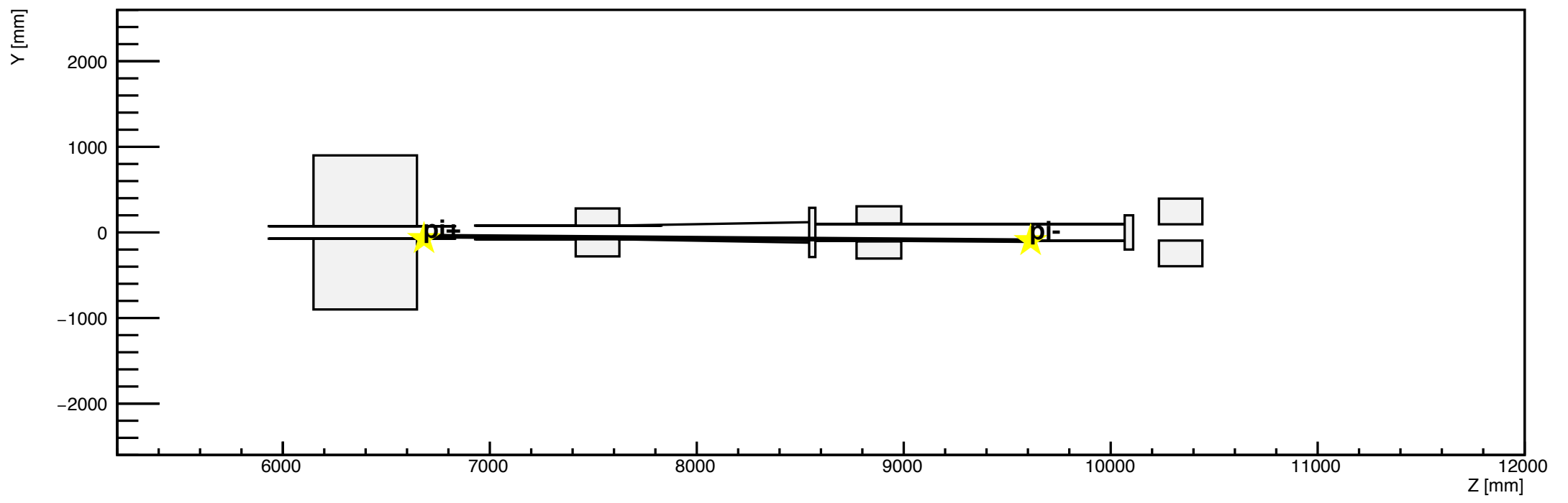

h2

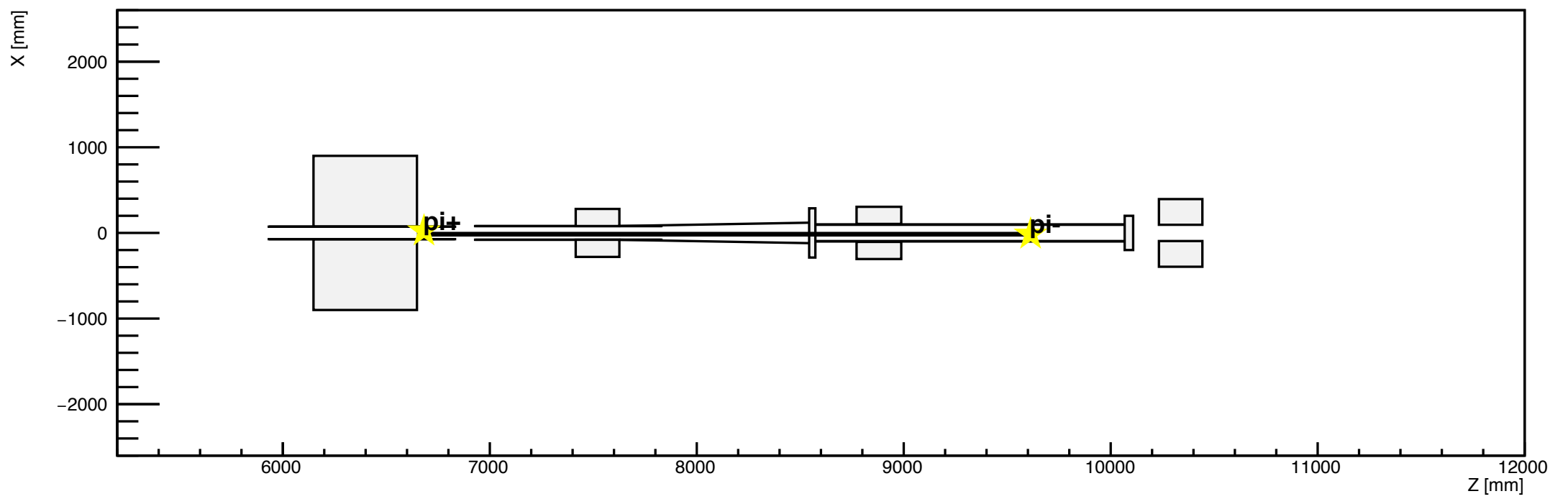

h1

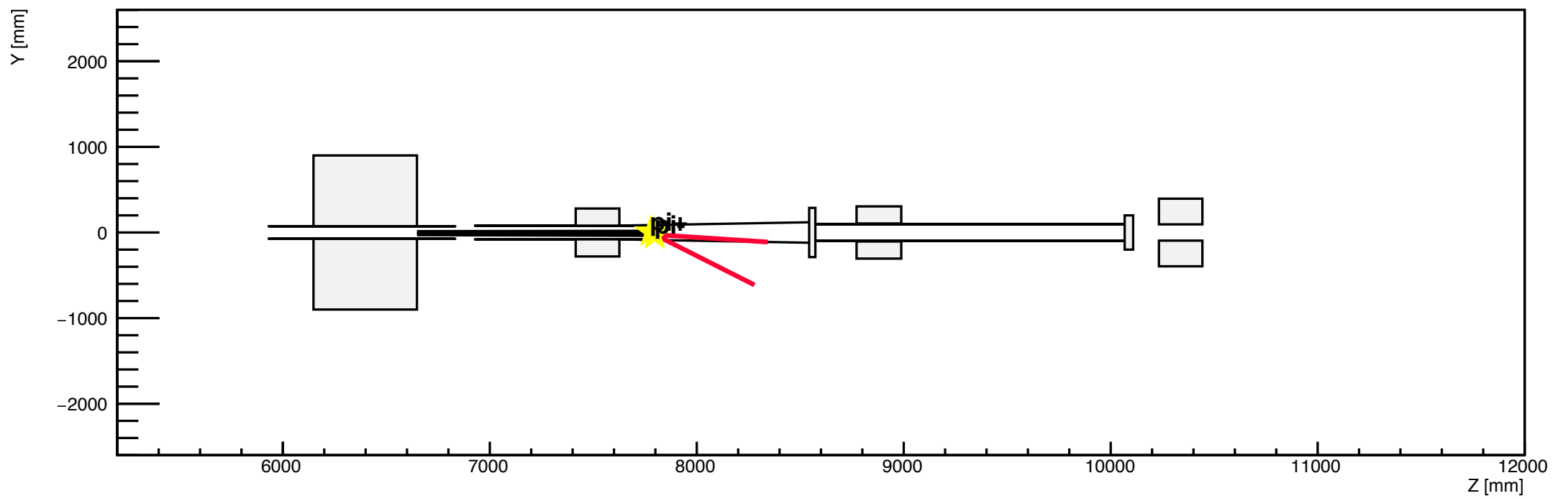

h2

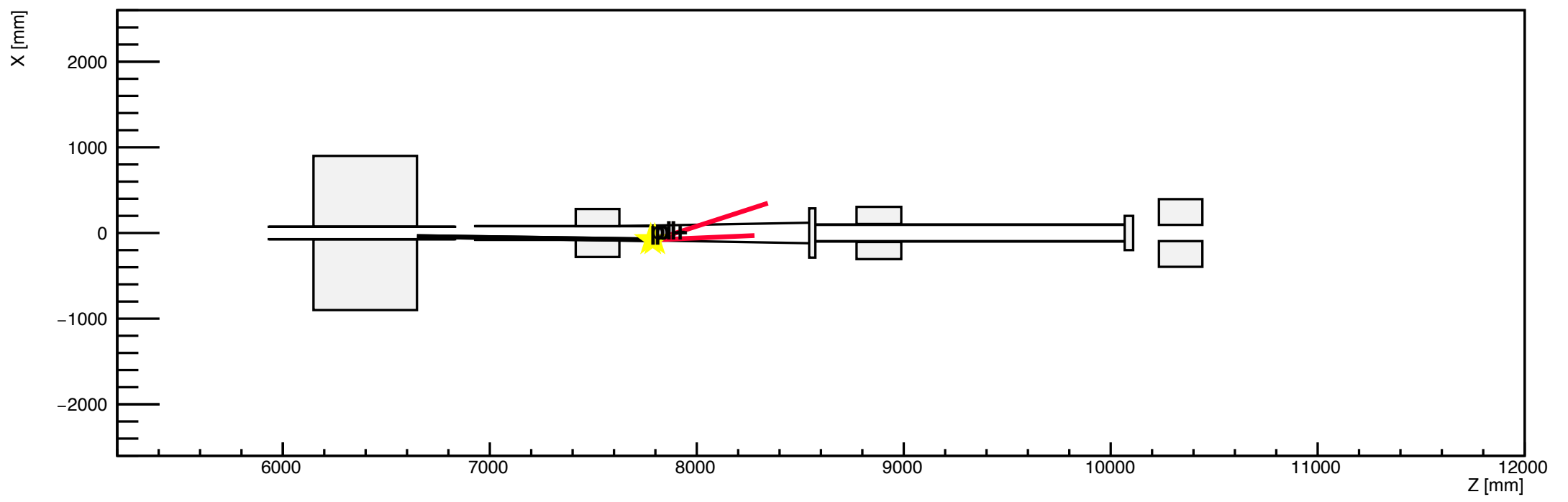

h1

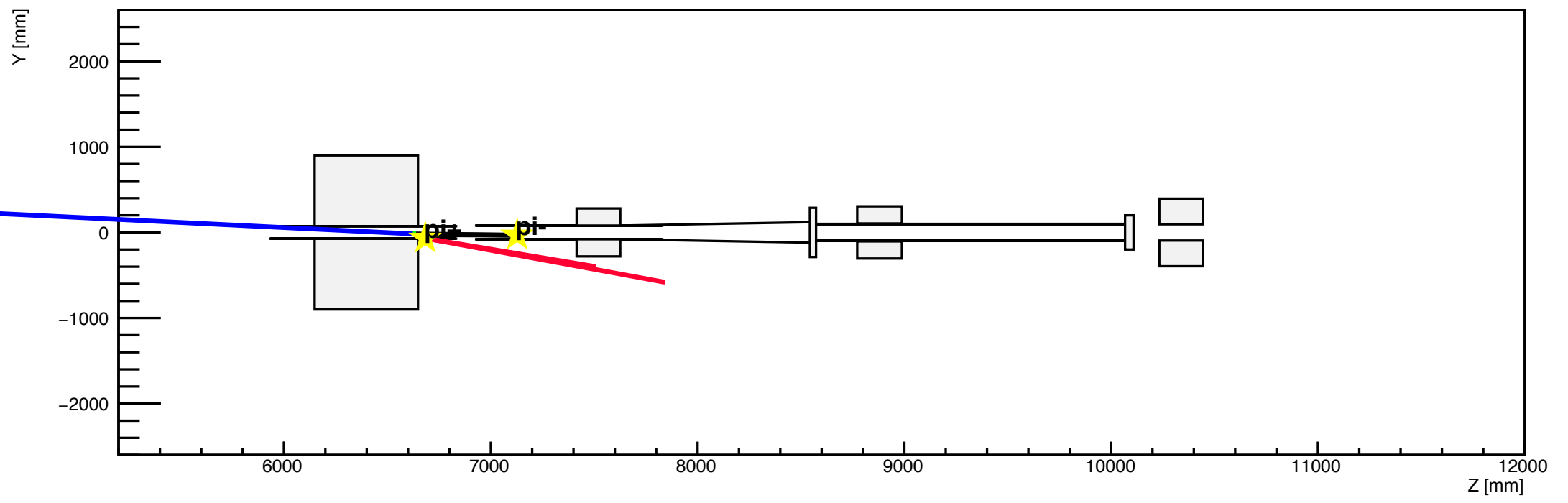

h2

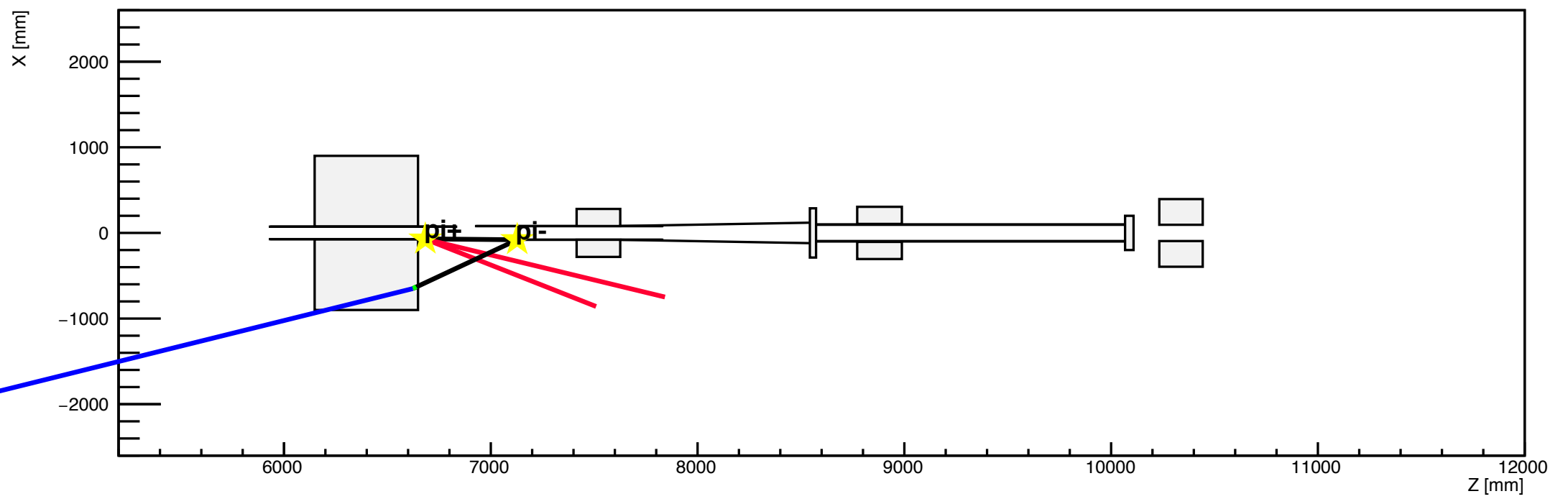

h1

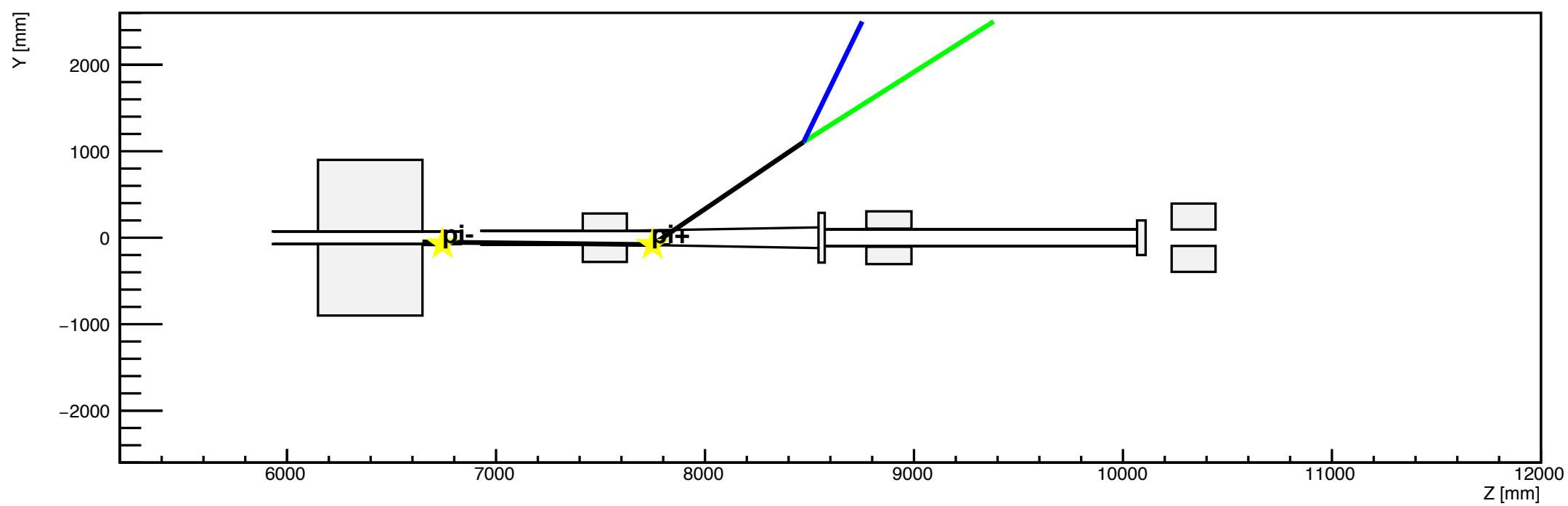

h2

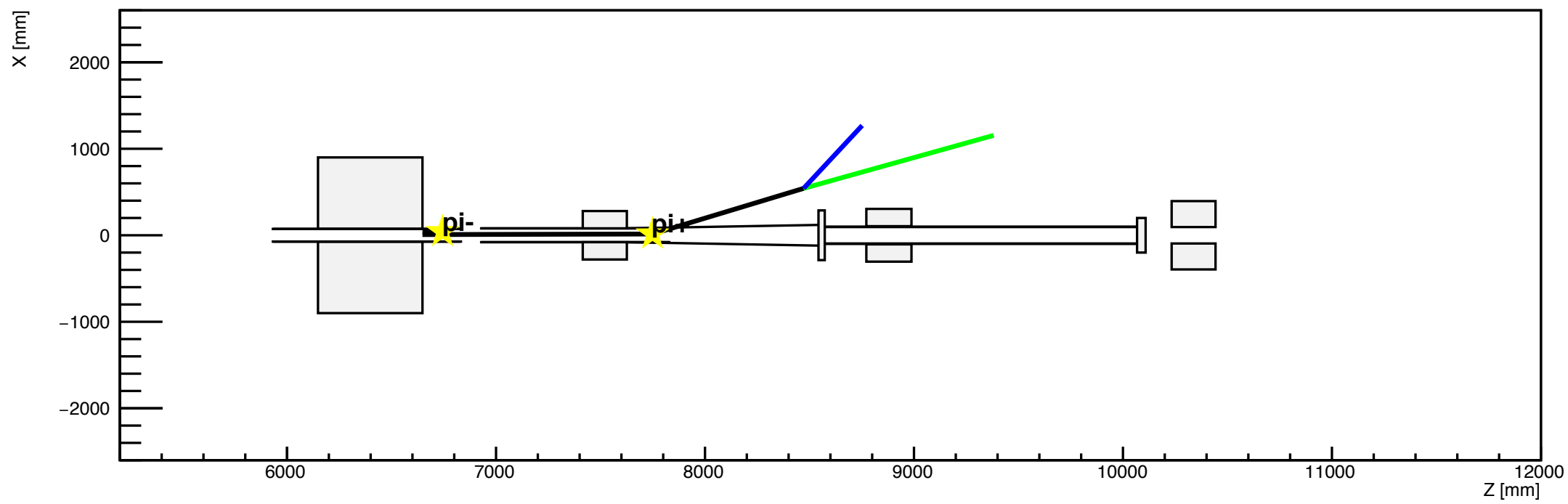

h1

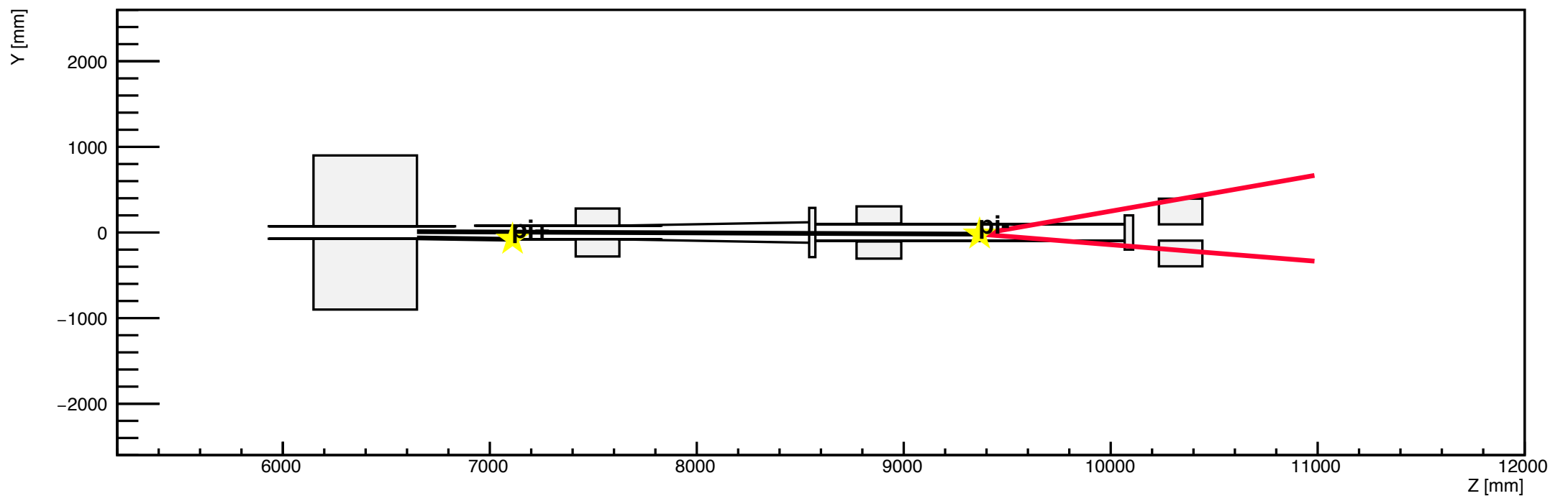

h2

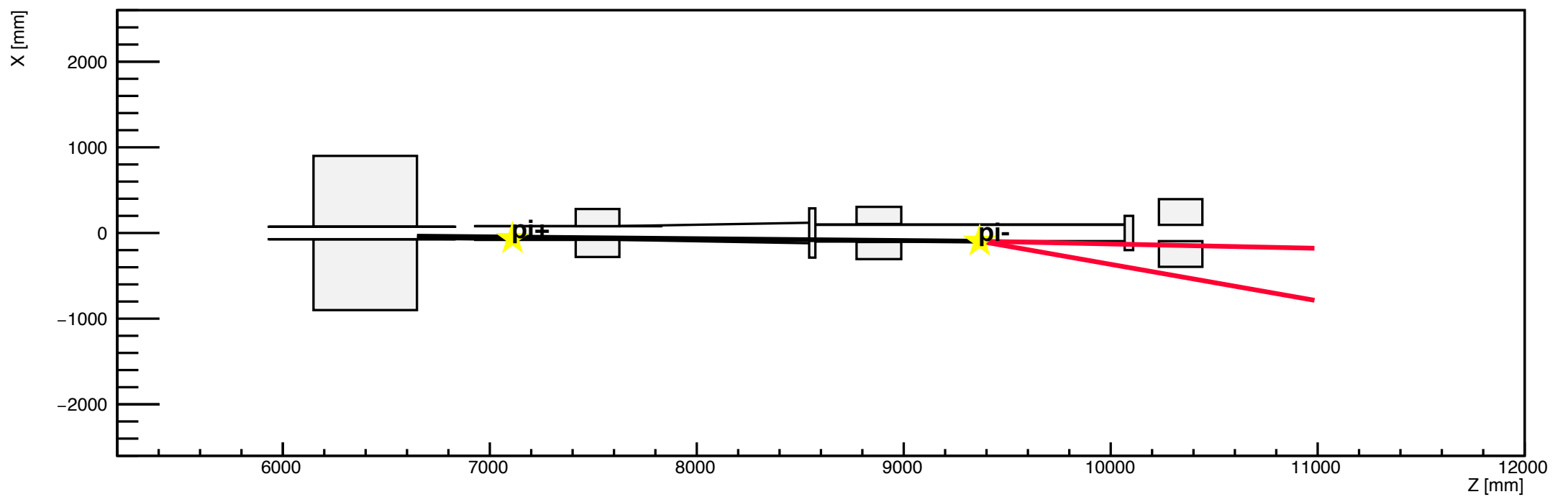

h1

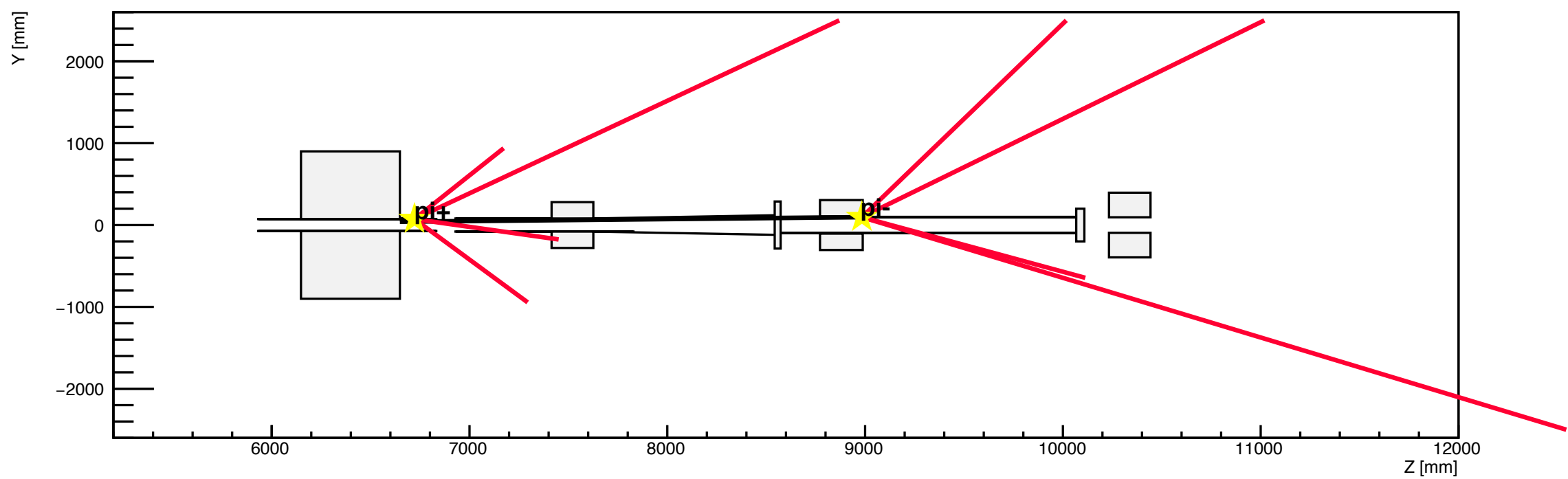

h2

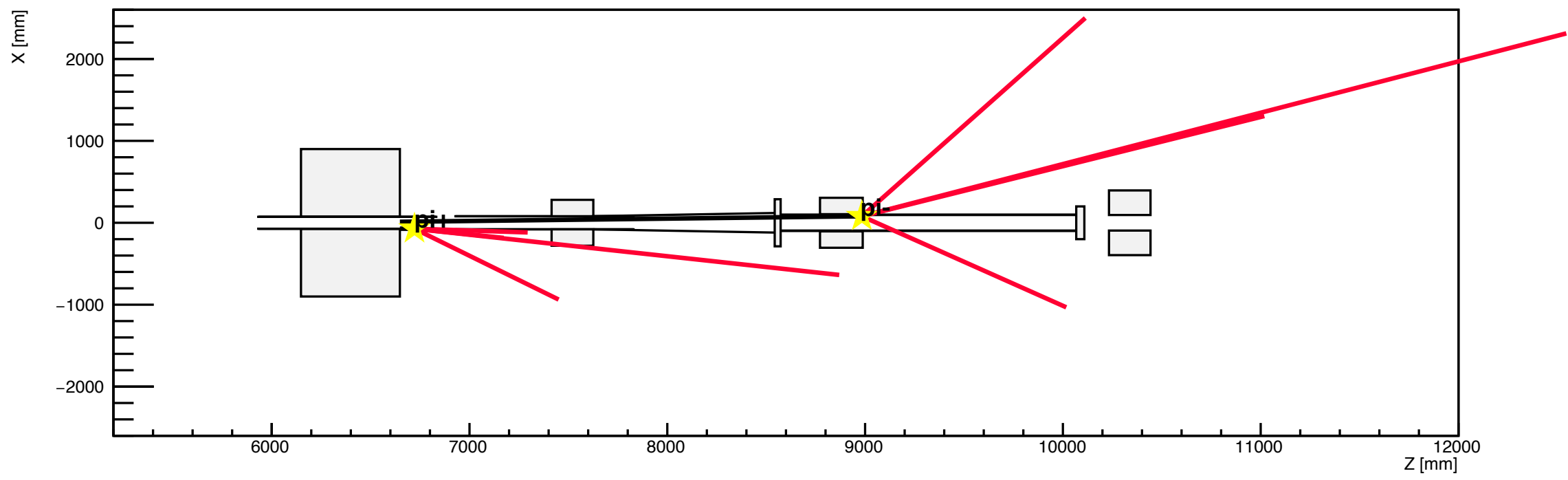

h1

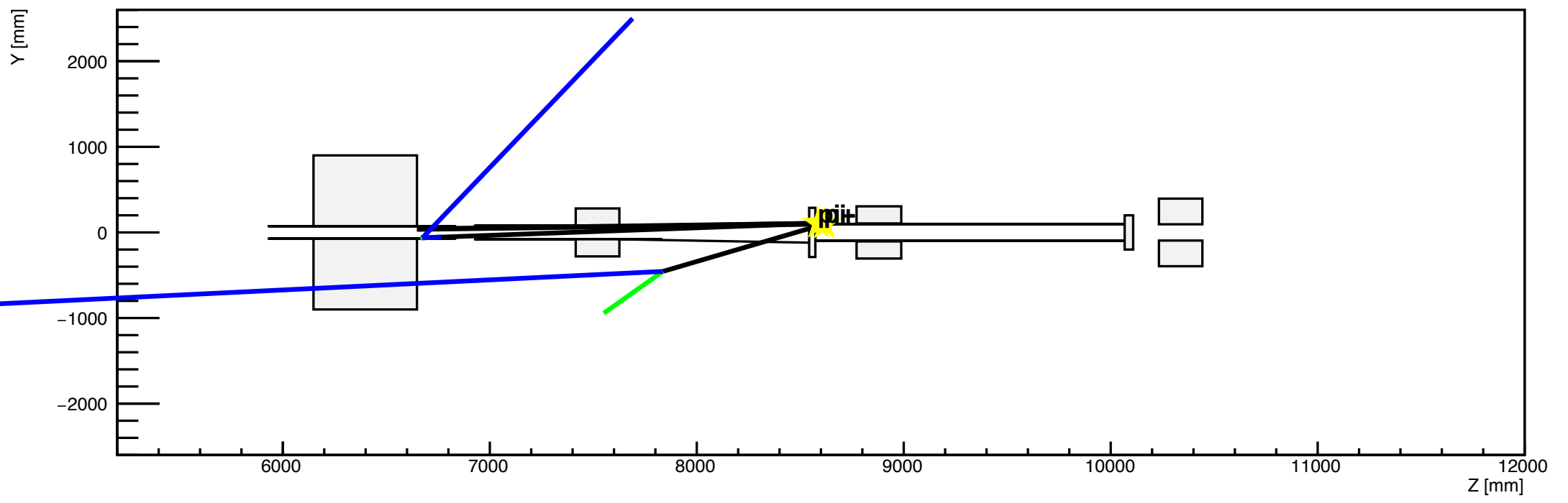

h2

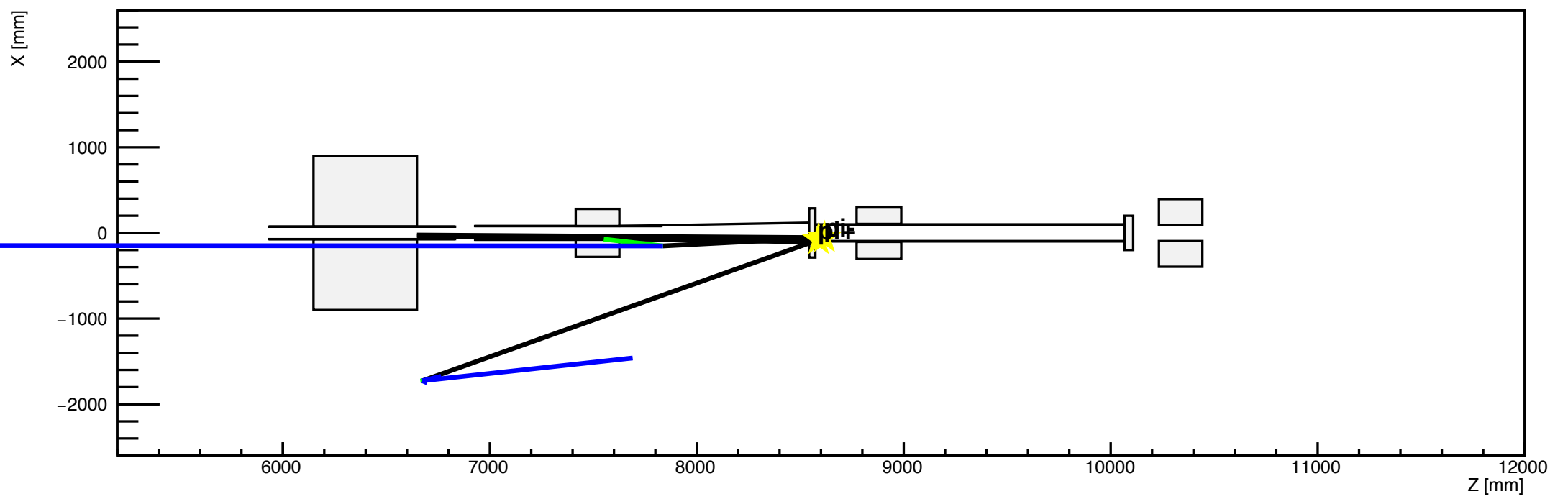

h1

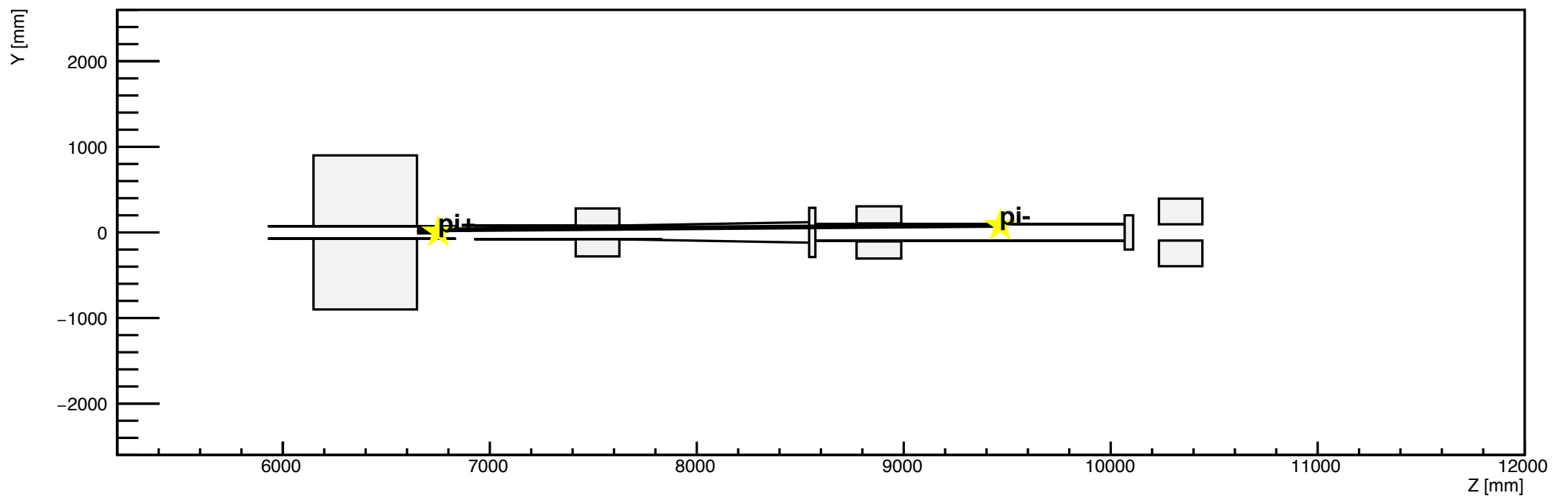

h2

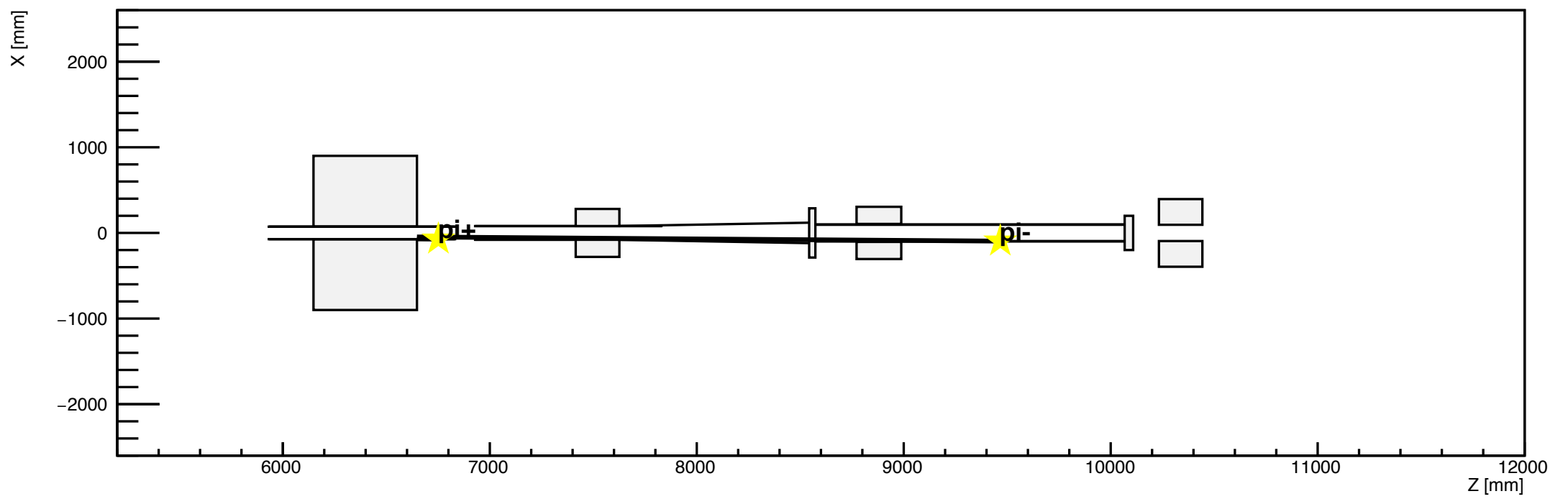

h1

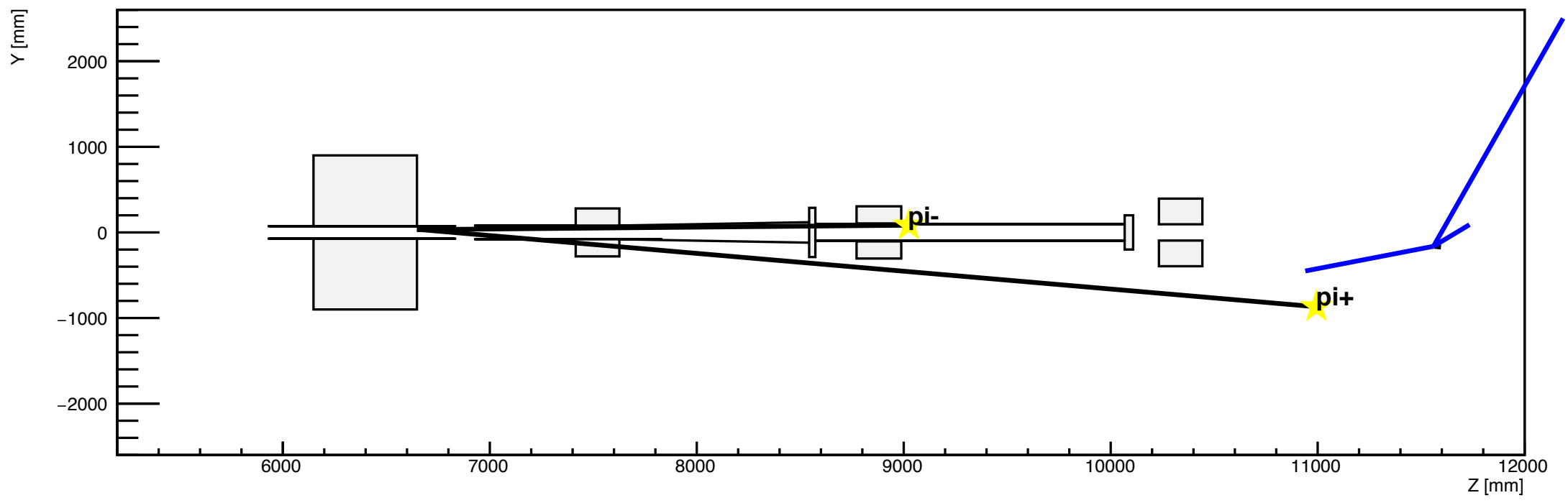

h2

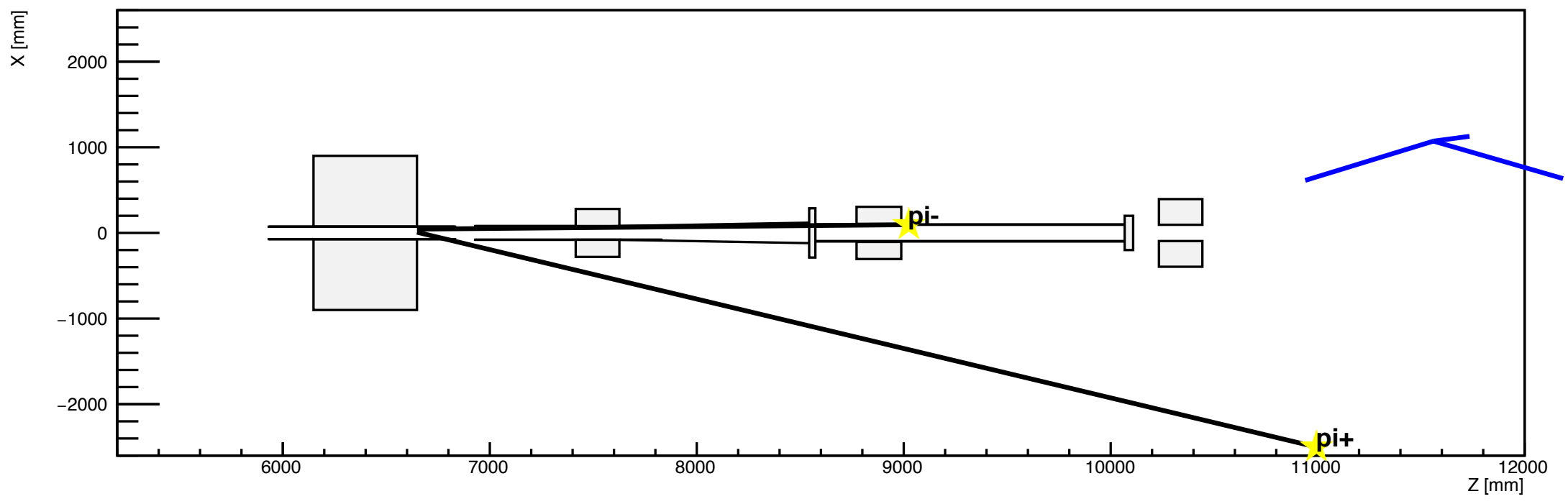

h1

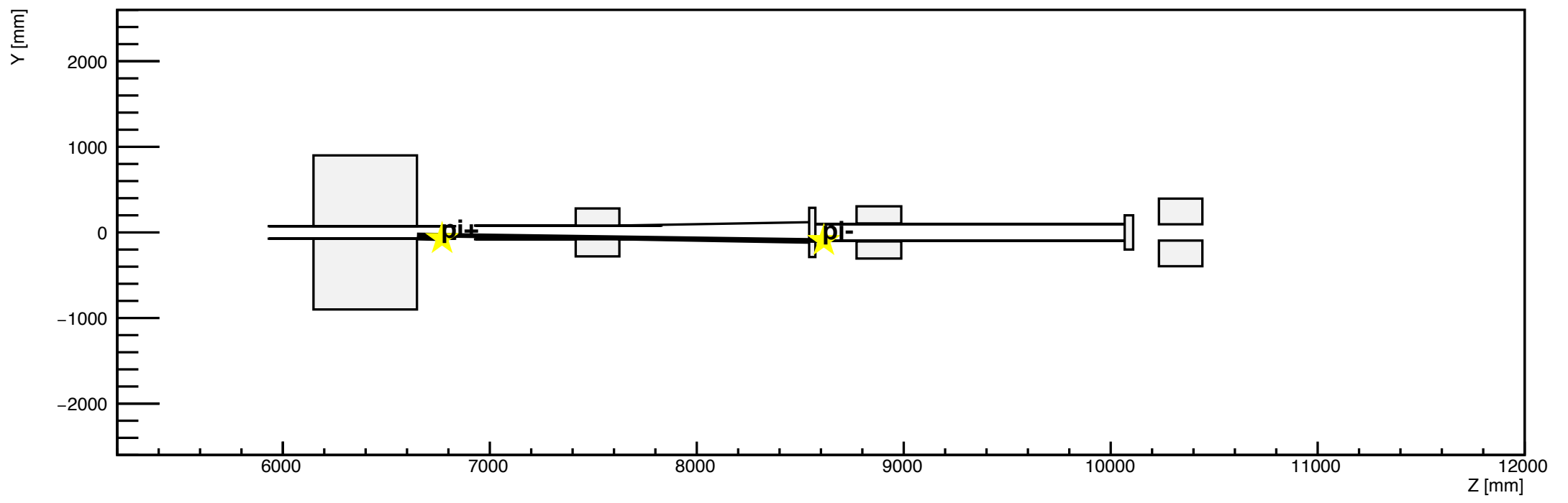

h2

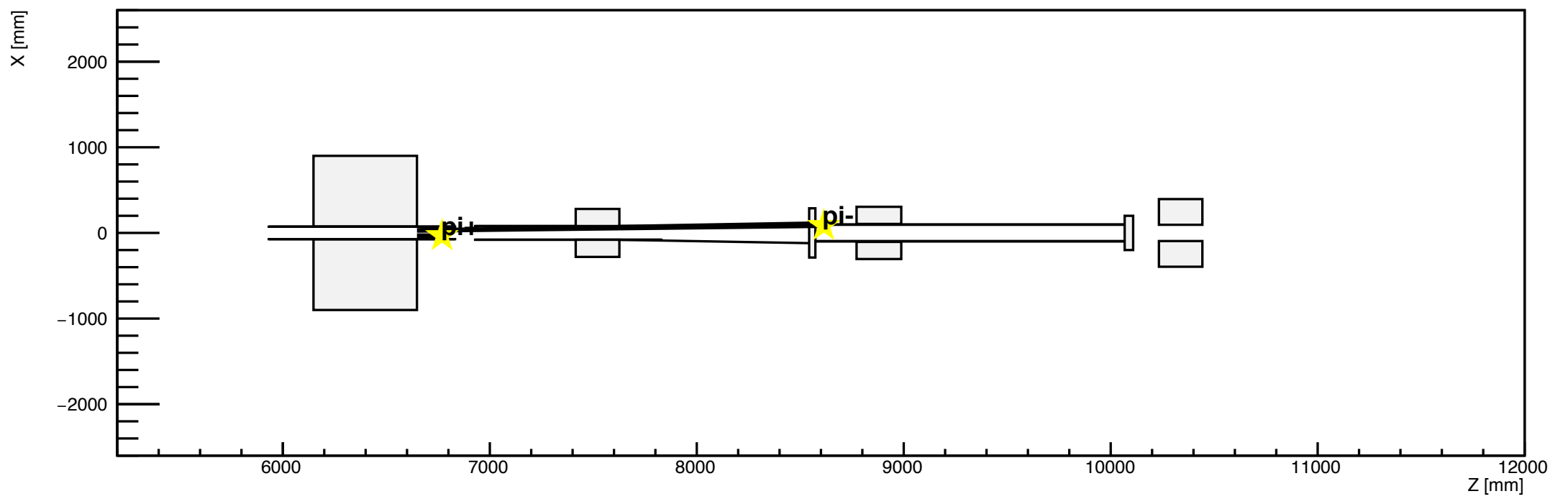

h1

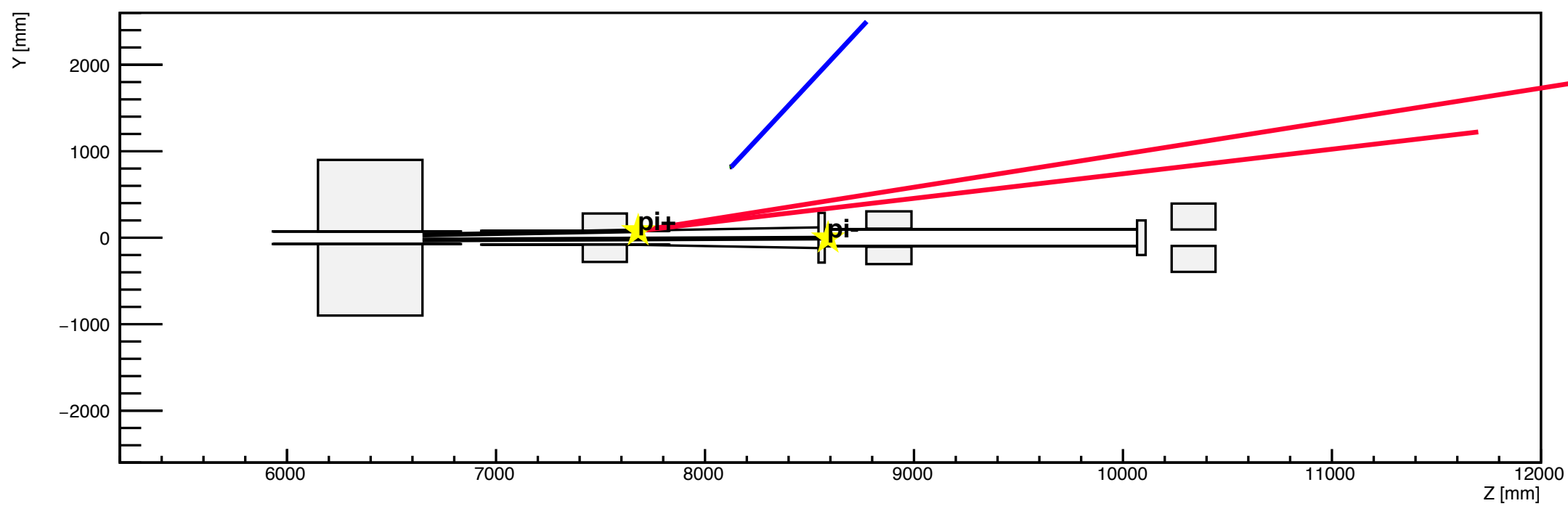

h2

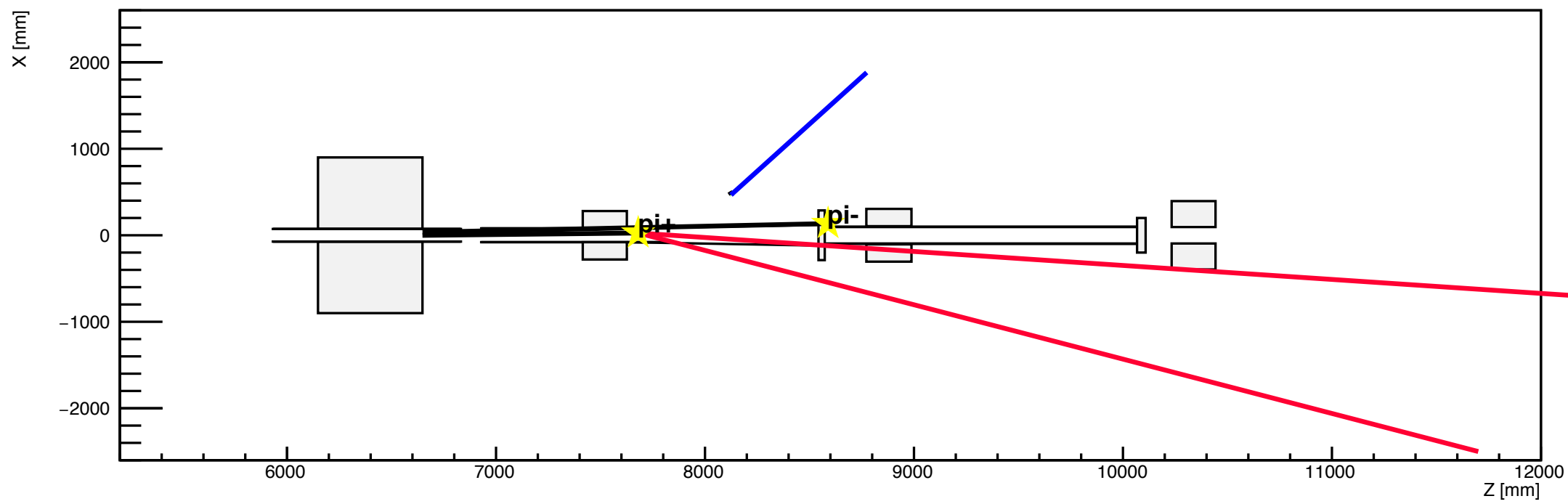

h1

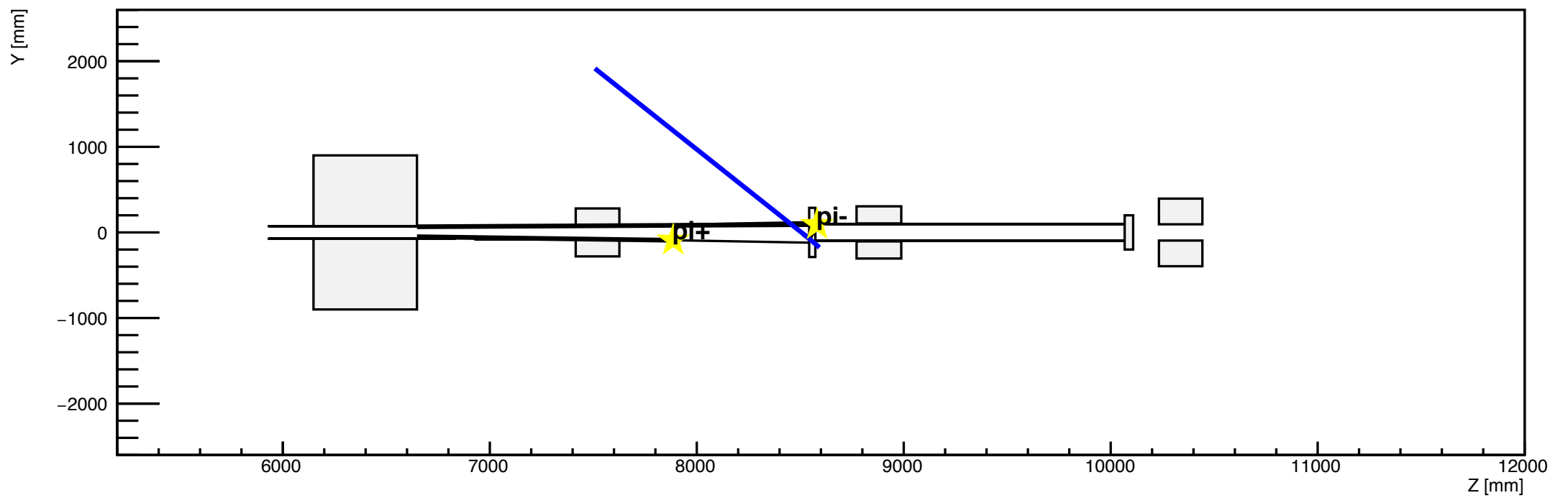

h2

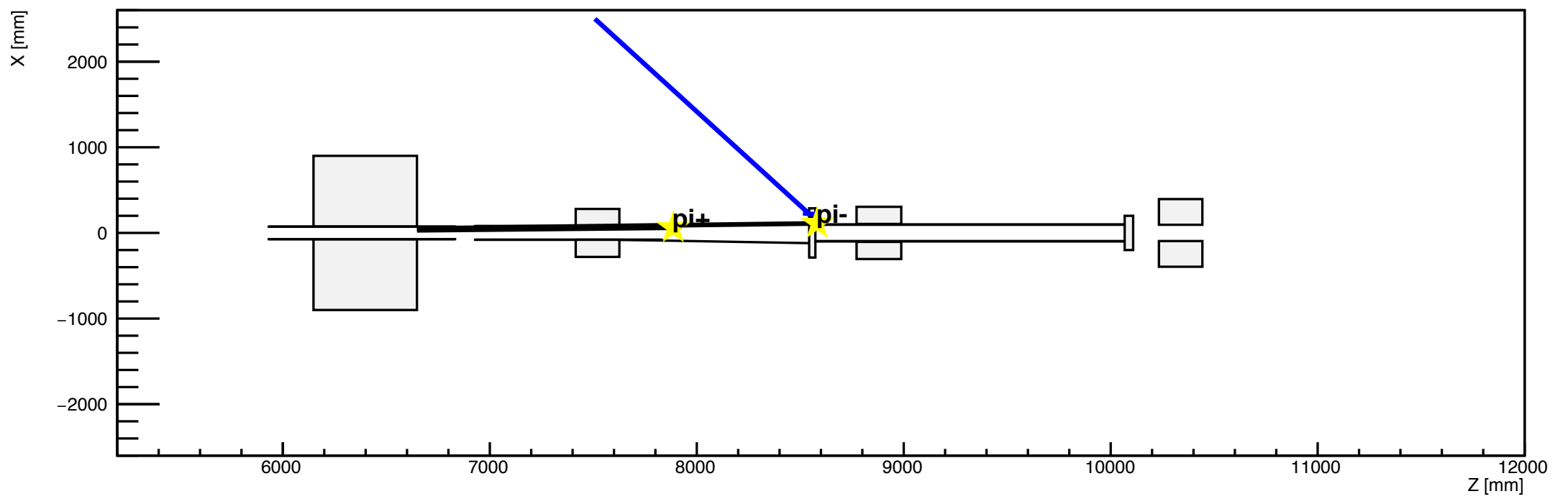

h1

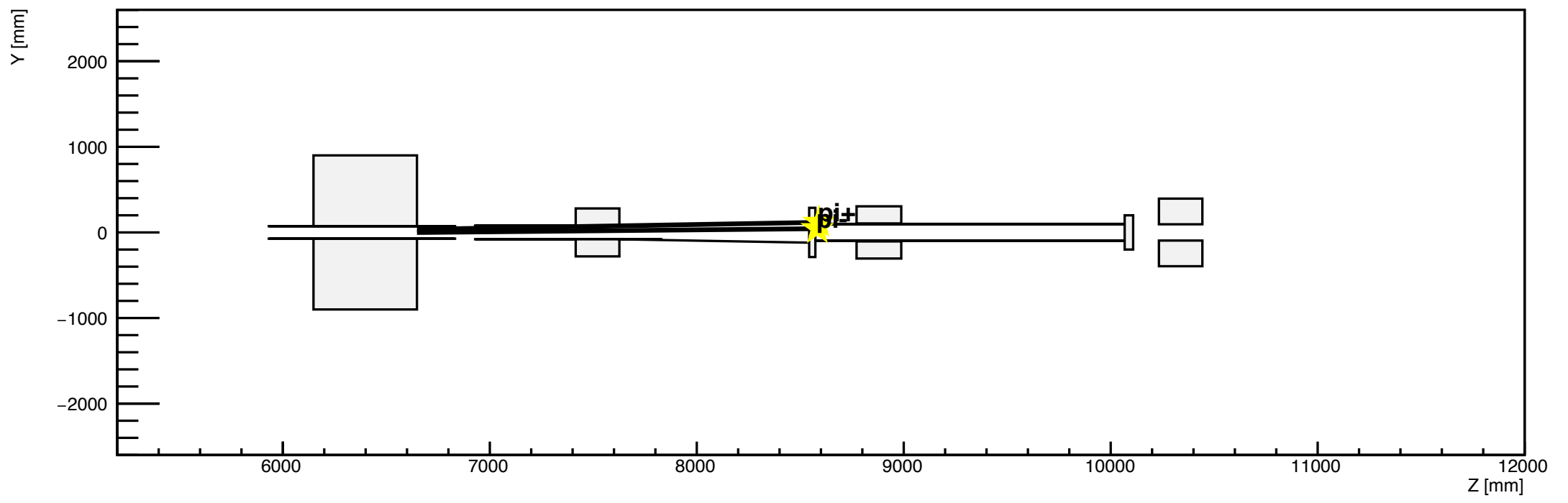

h2

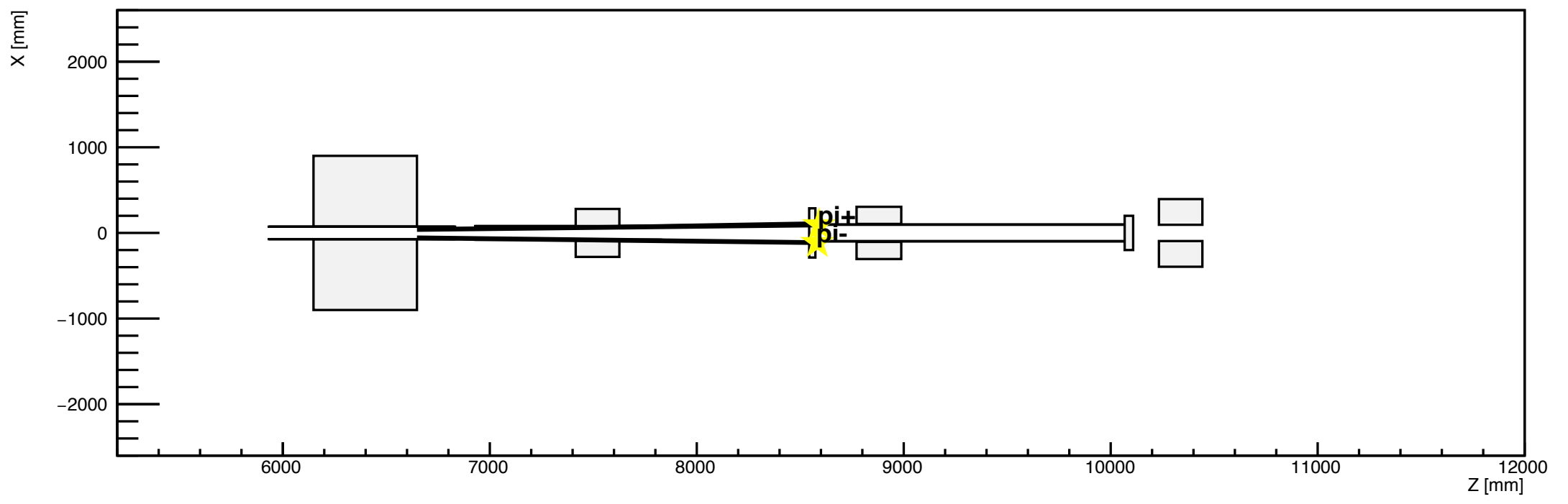

h1

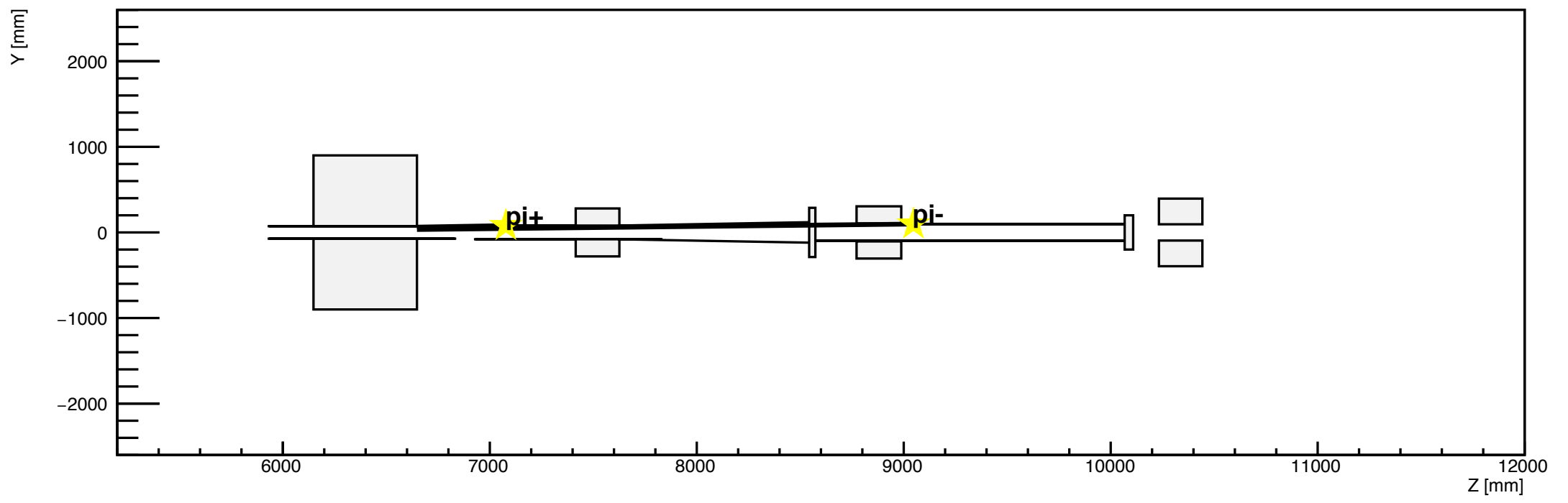

h2

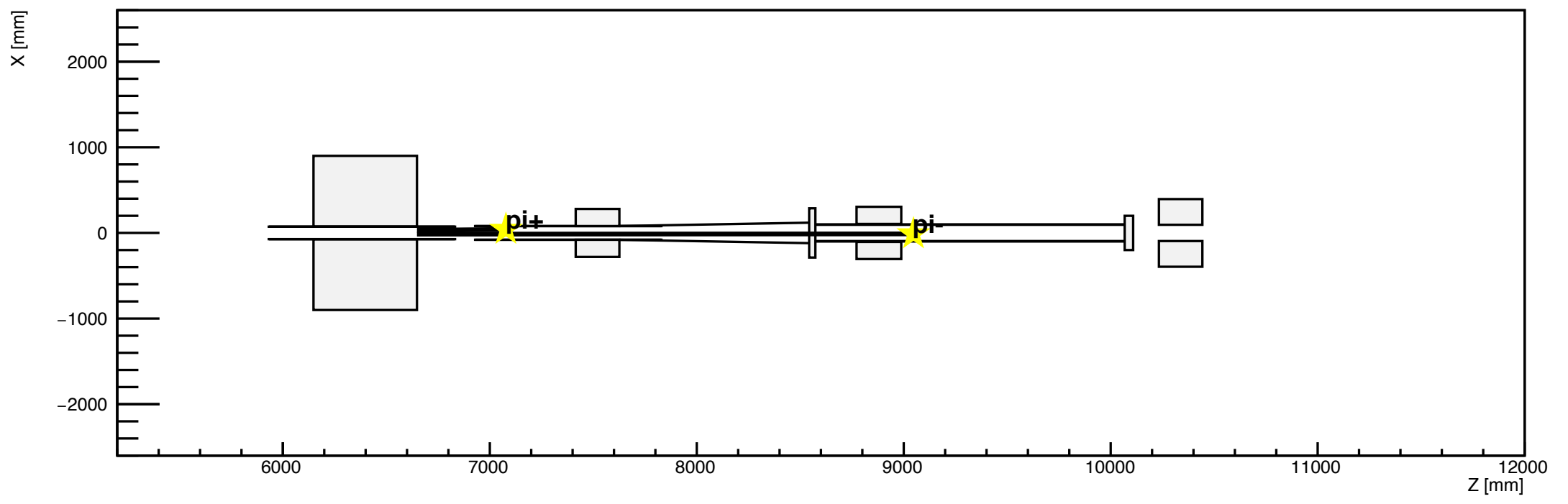

h1

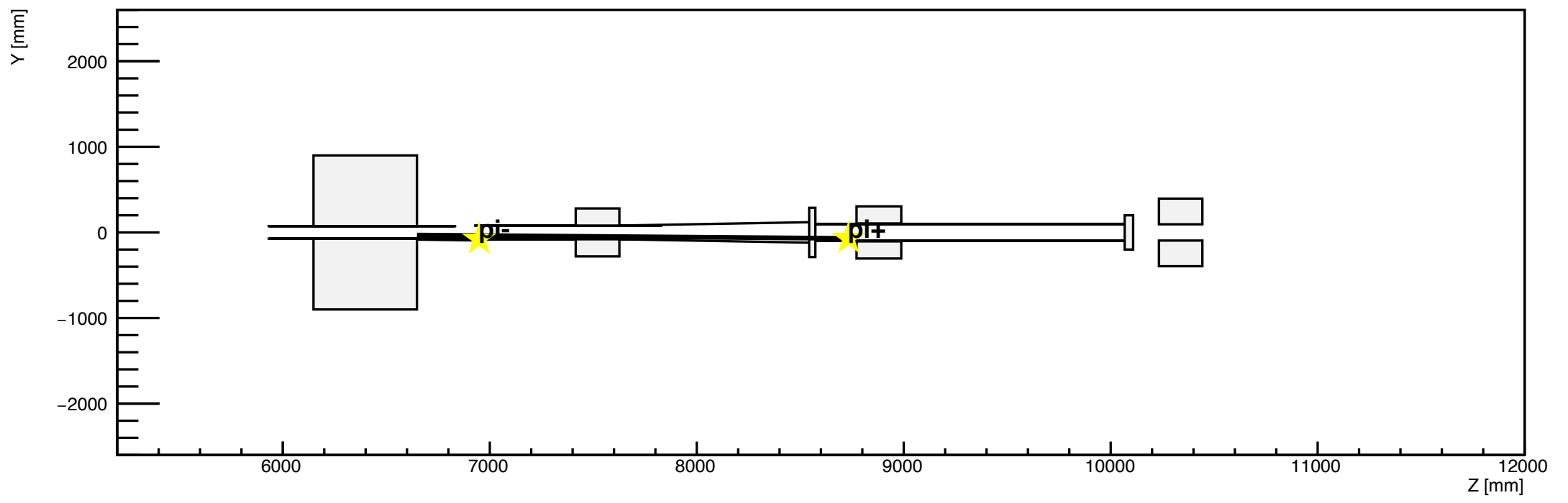

h2

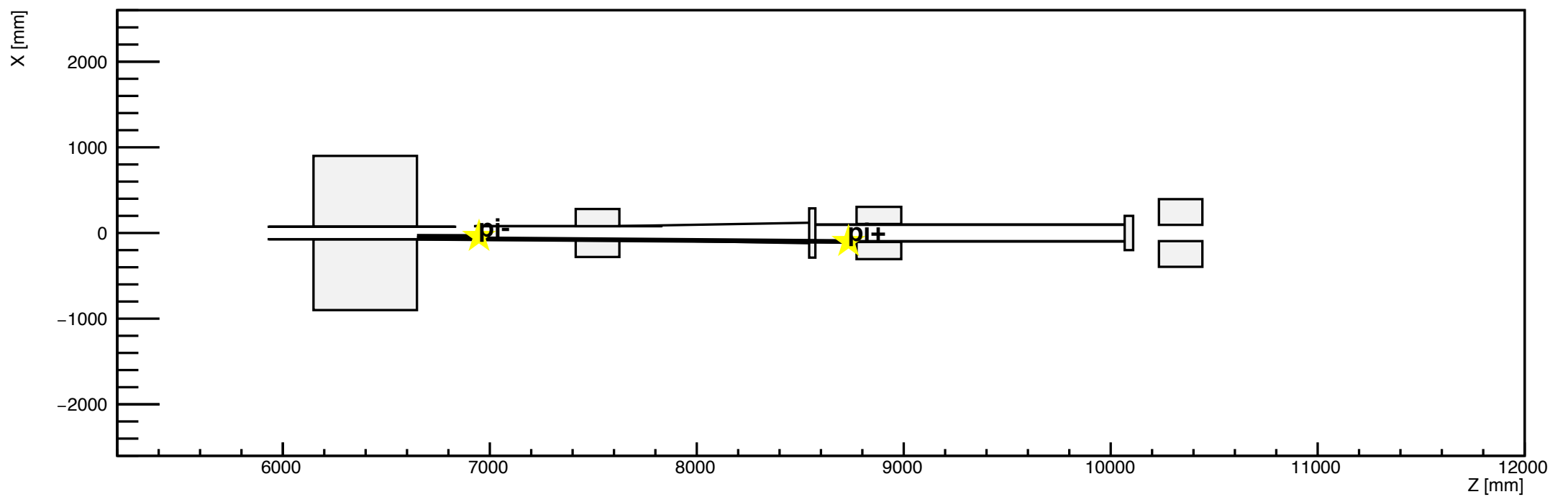

h1

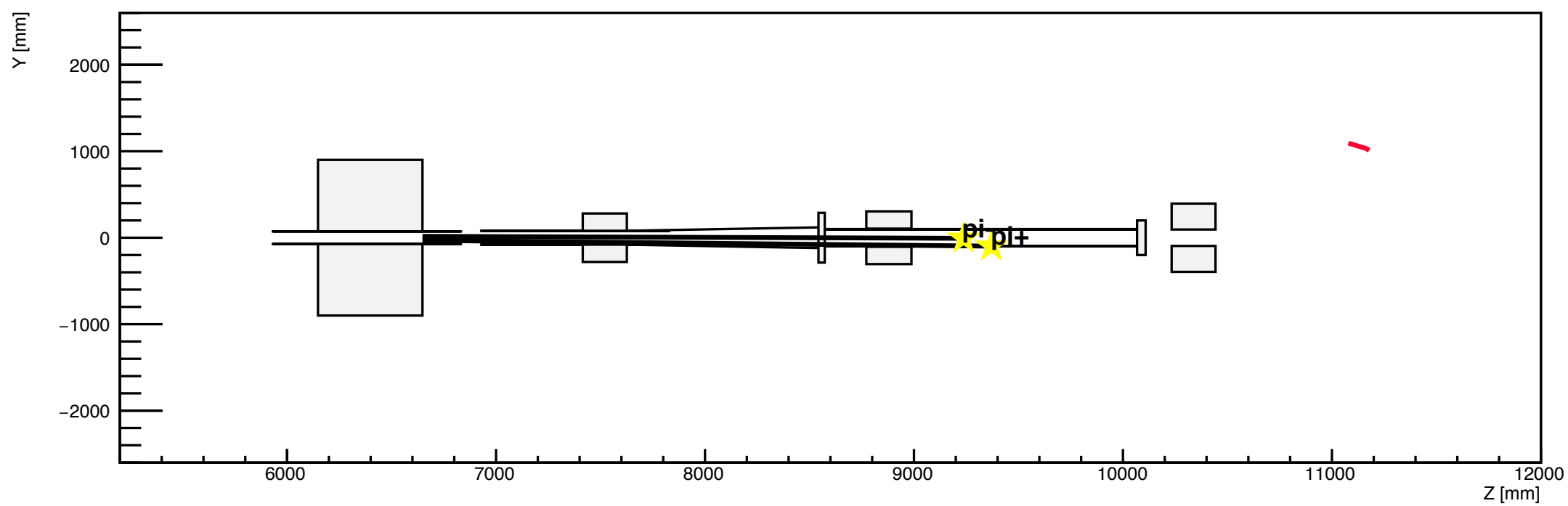

h2

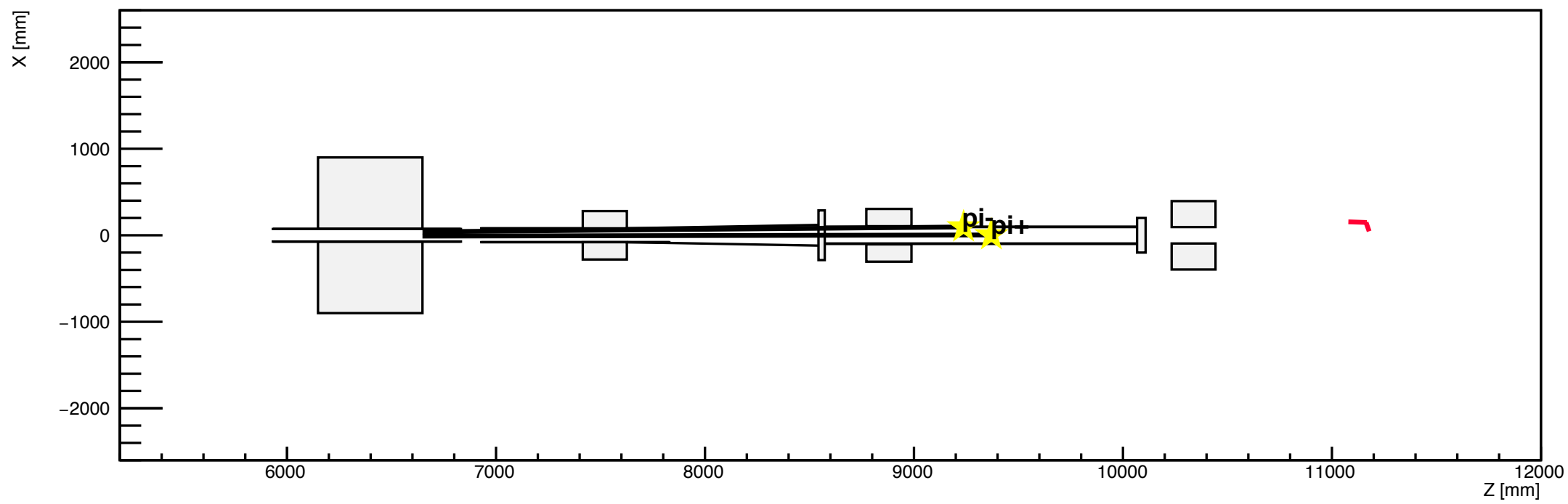

h1

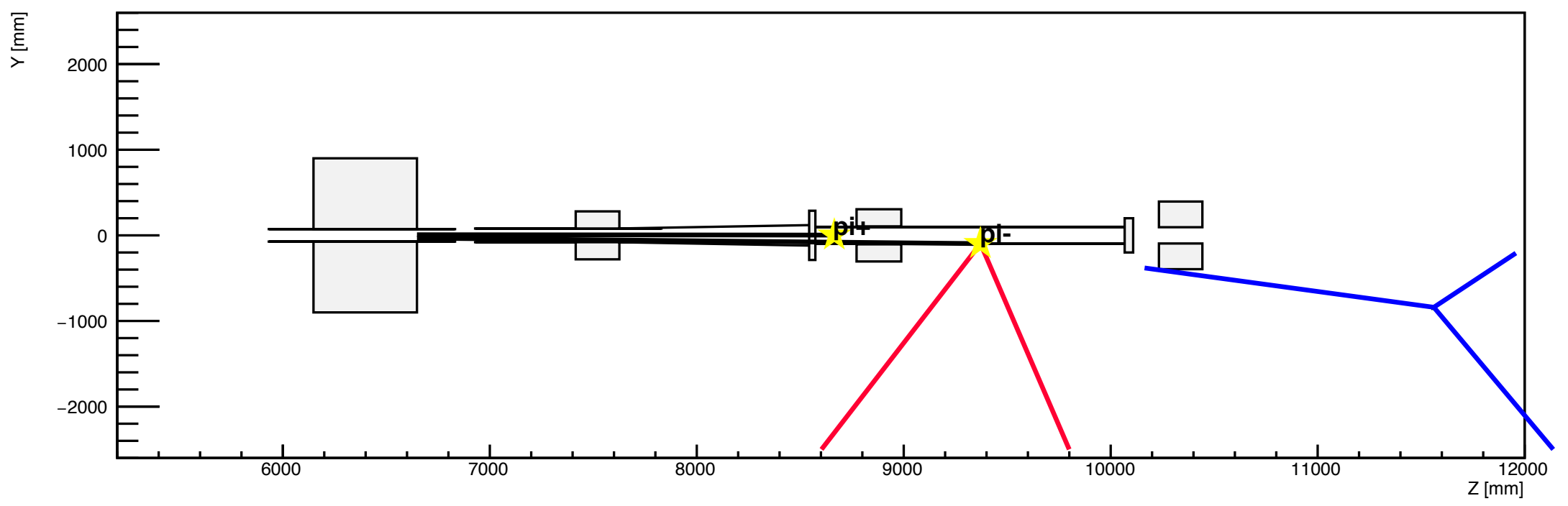

h2

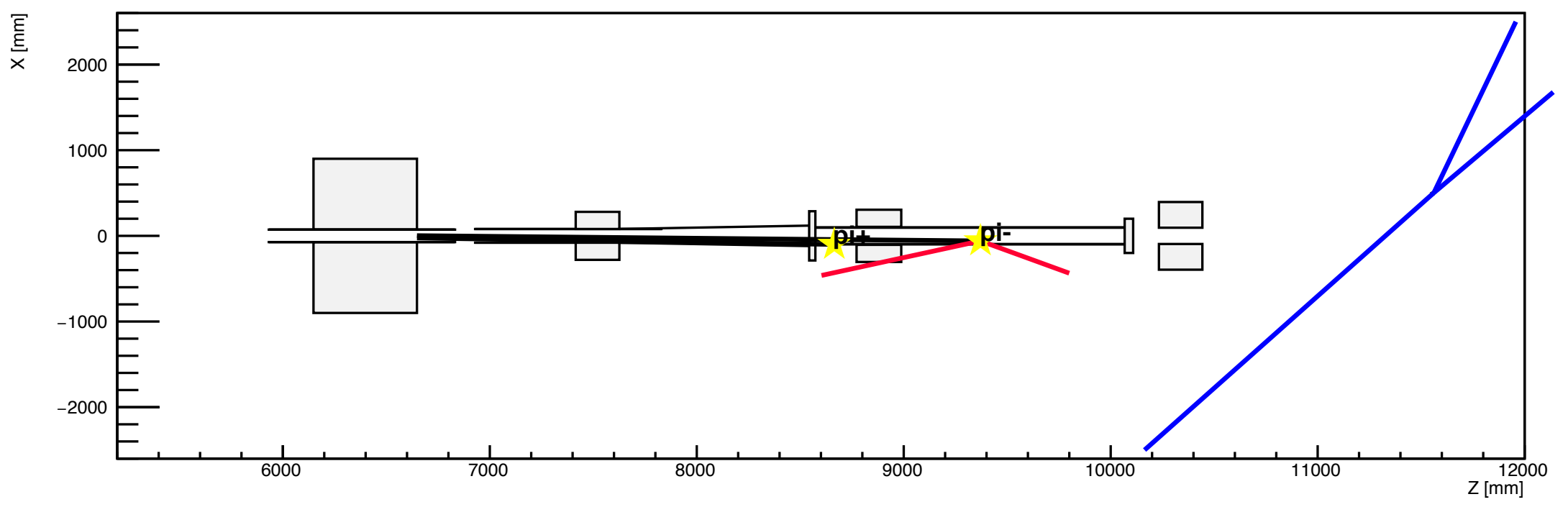

h1

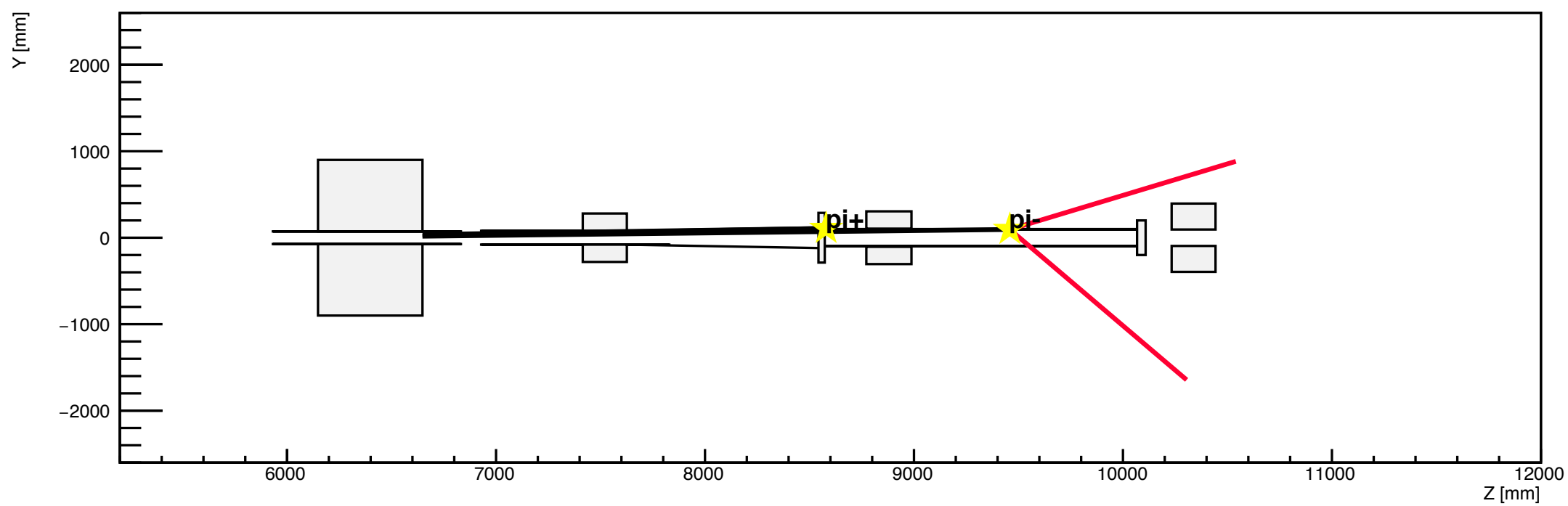

h2

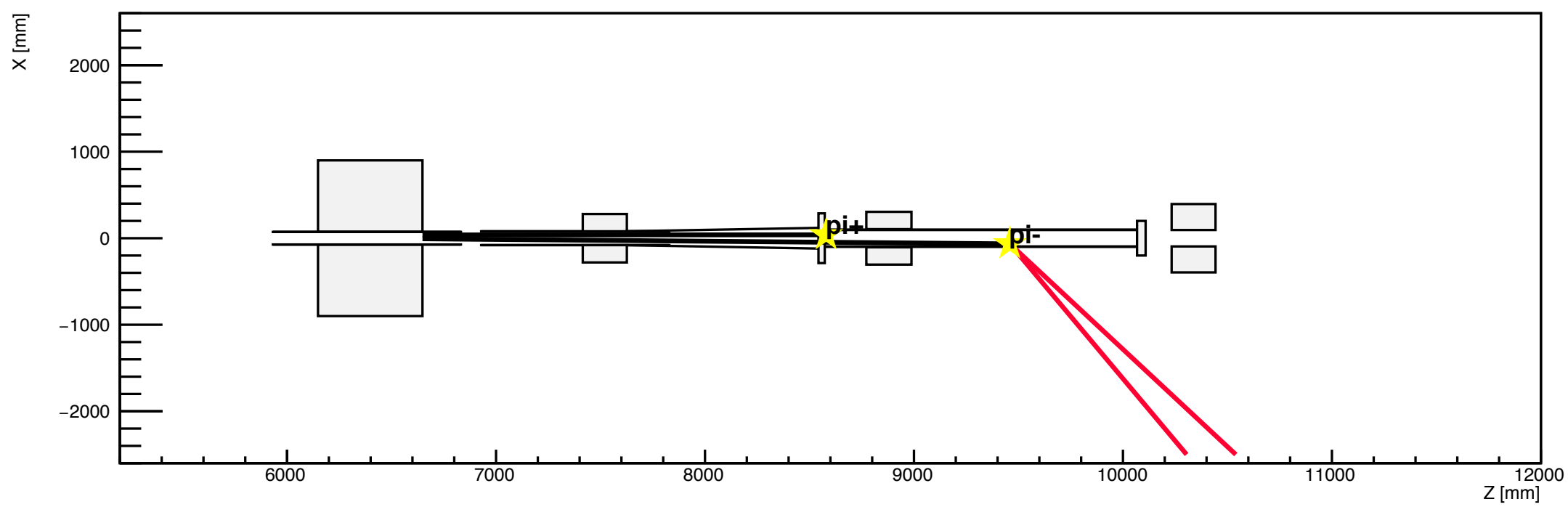

h1

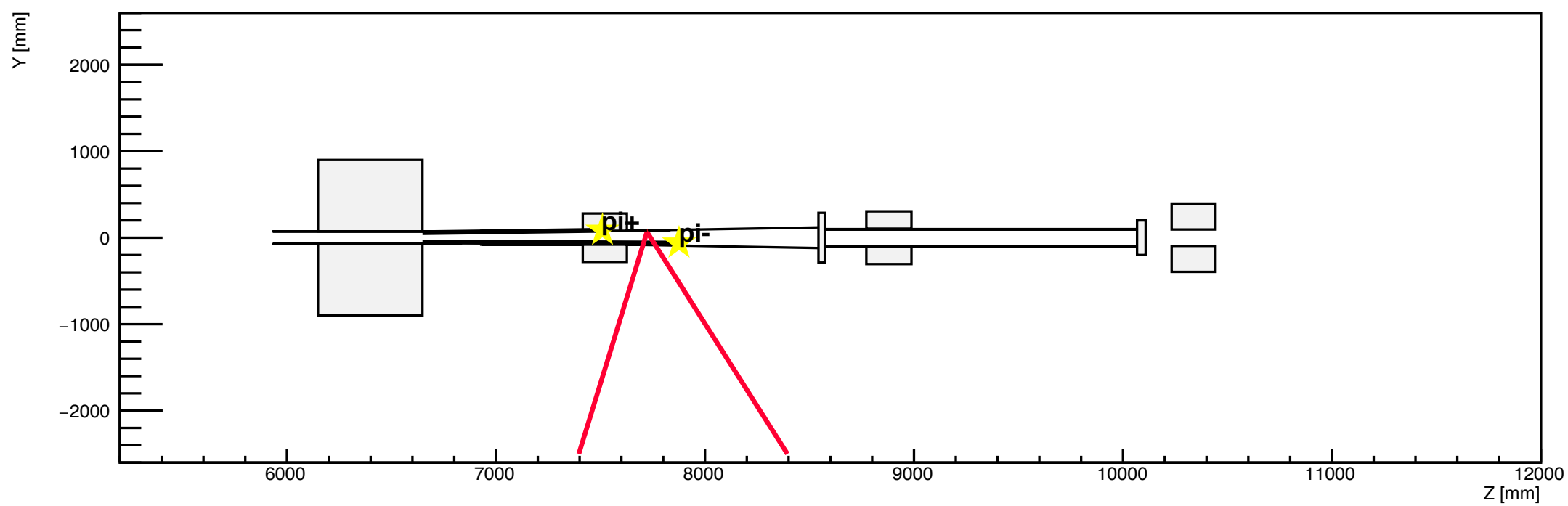

h2

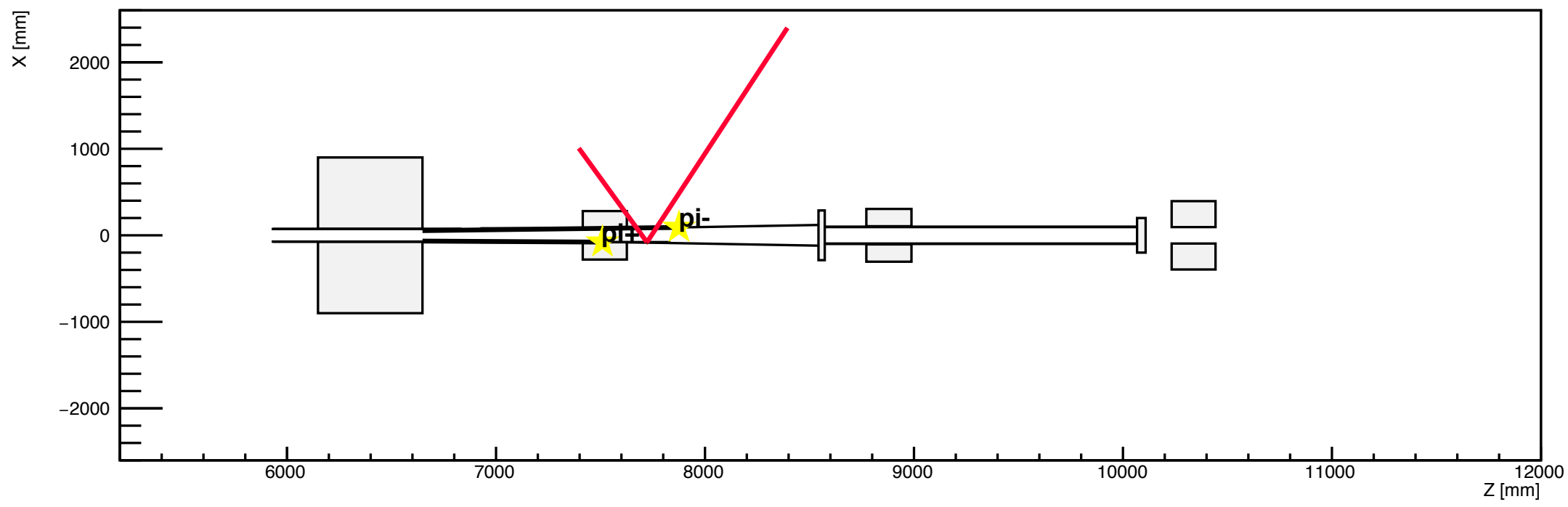

h1

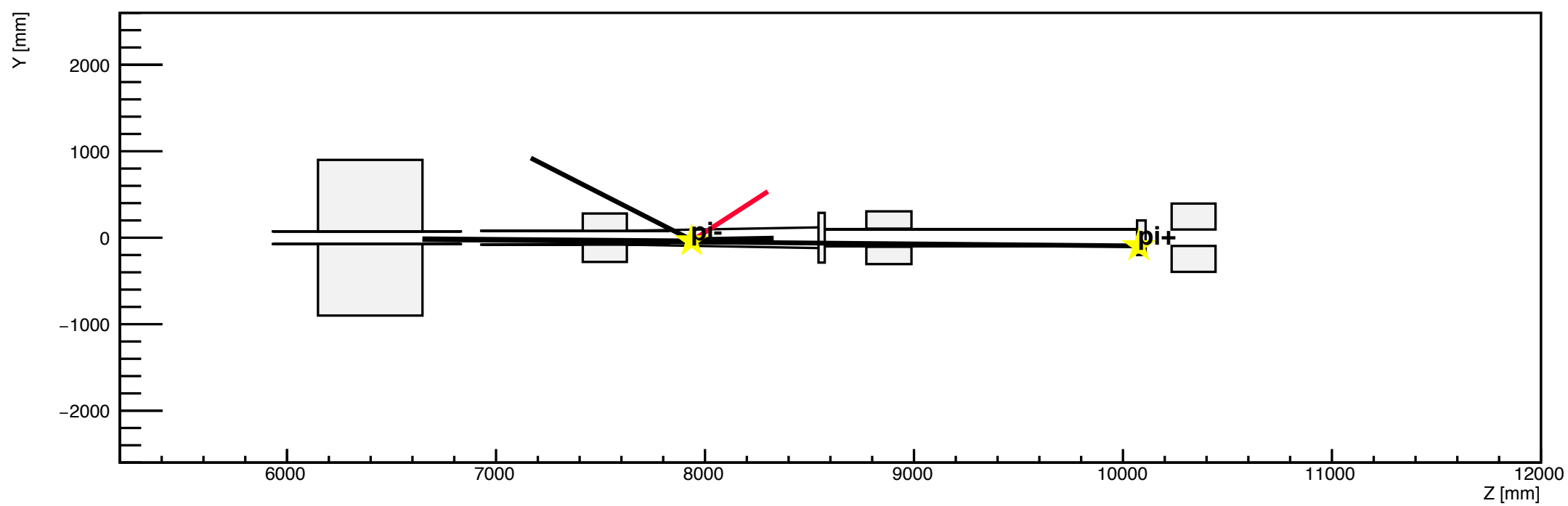

h2

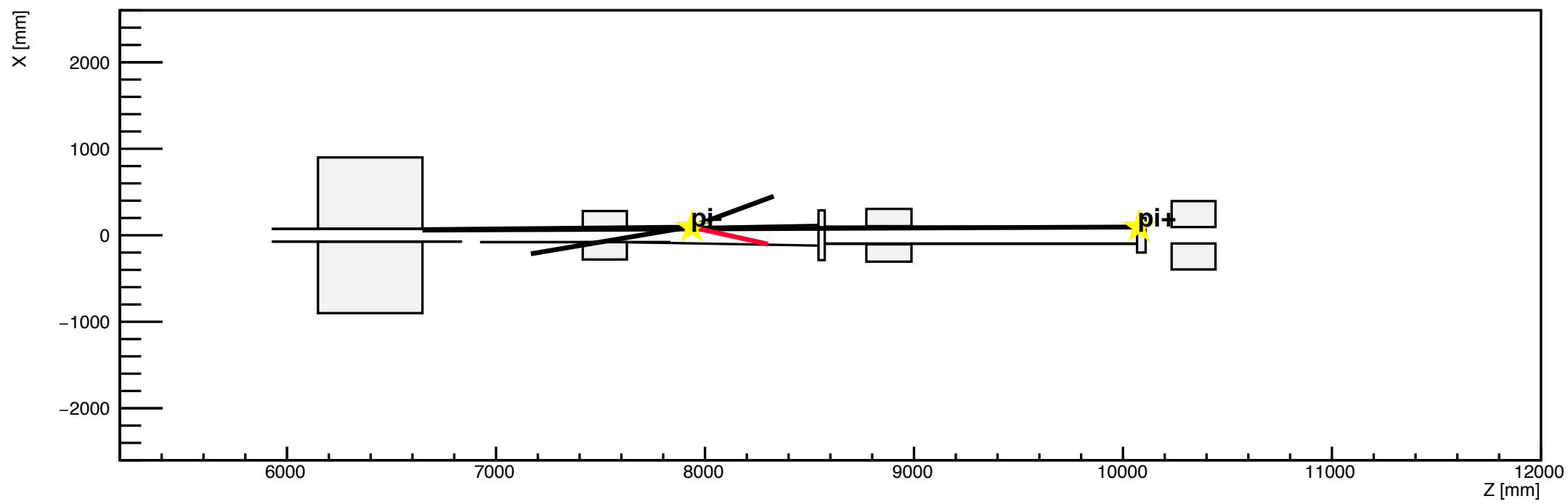

h1

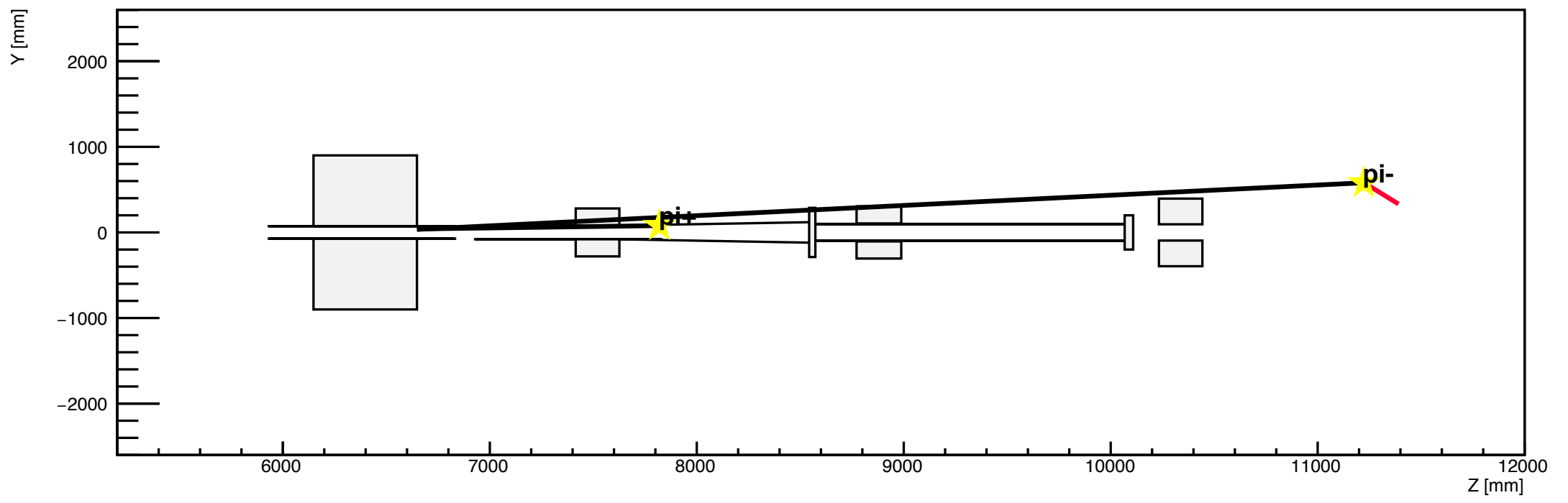

h2

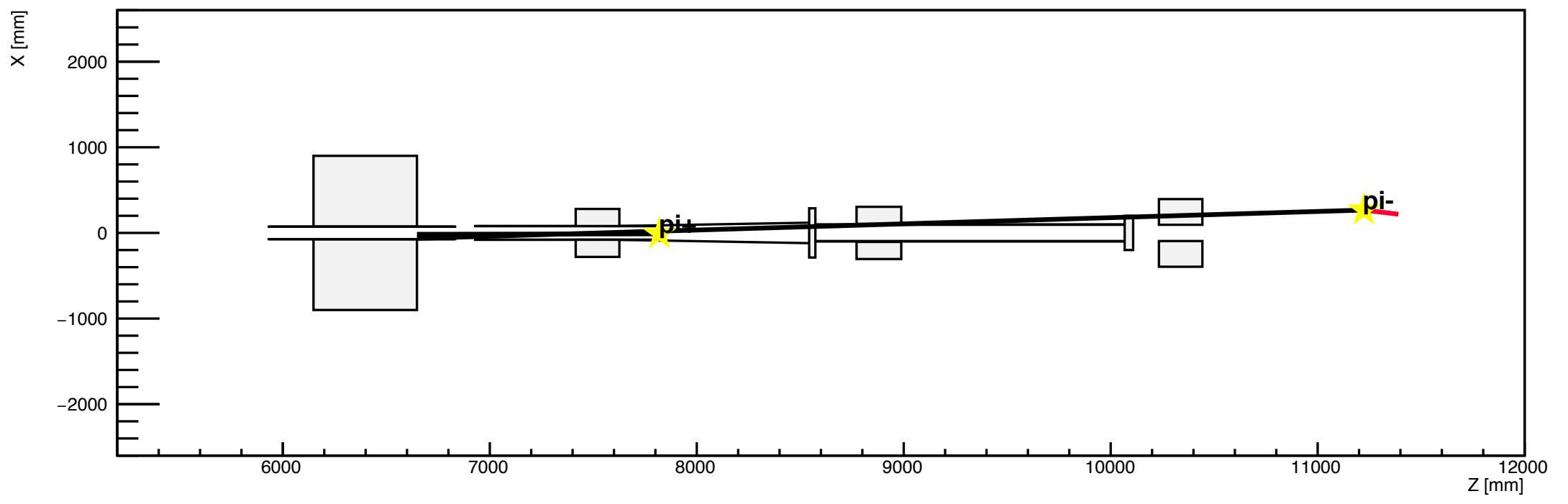

h1

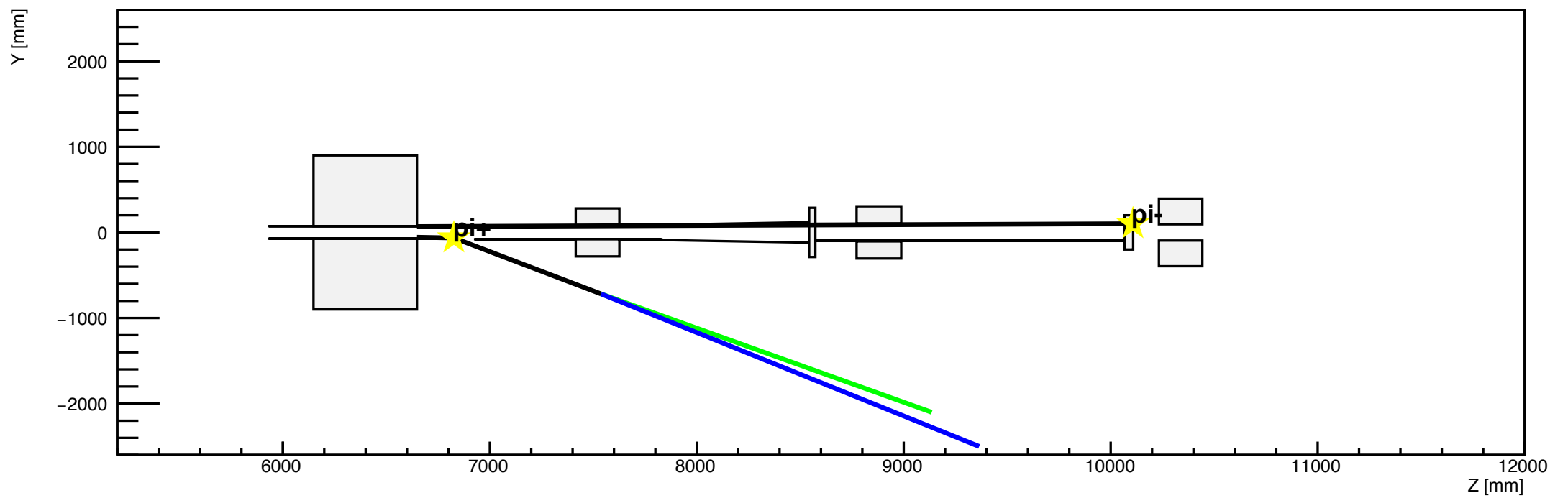

h2

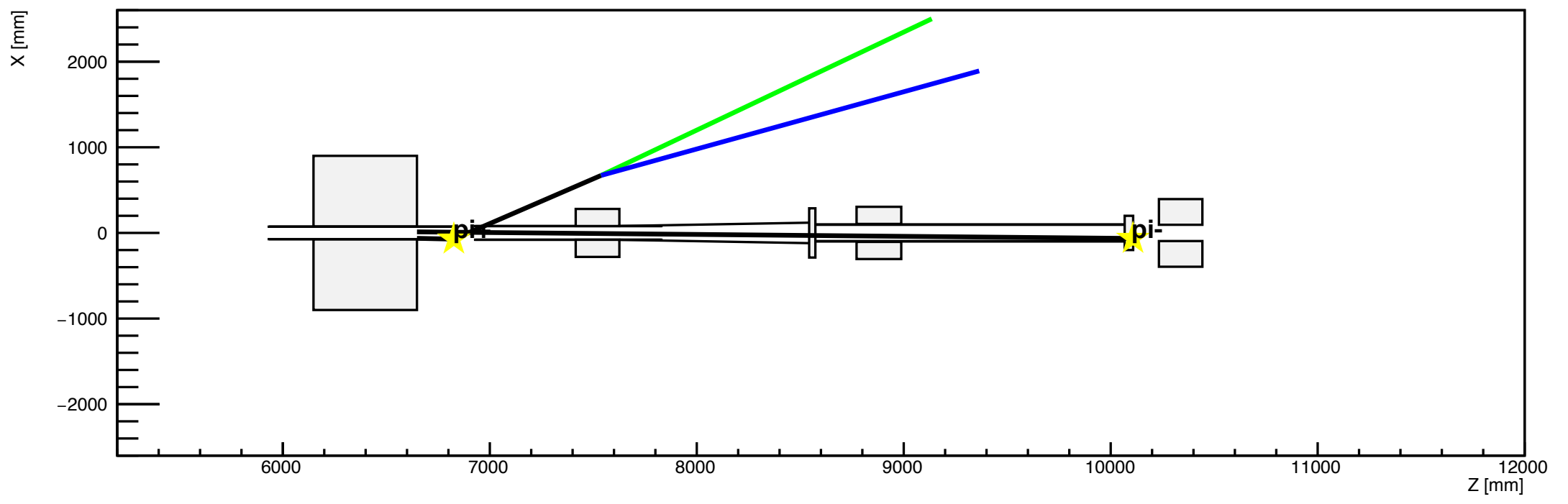

h1

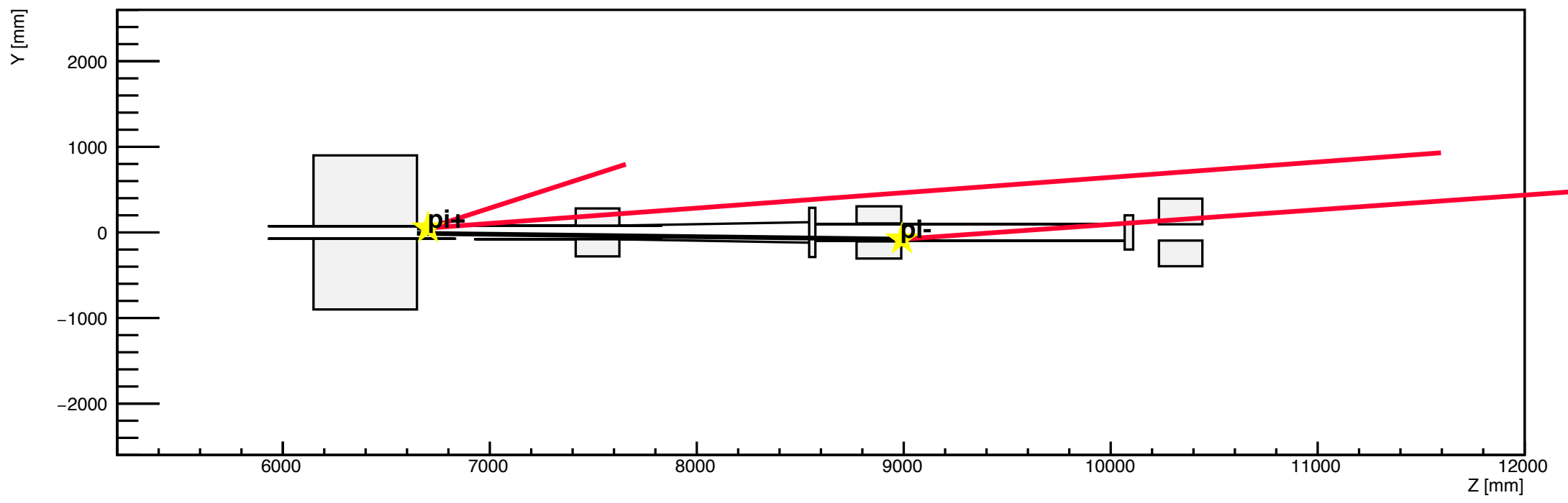

h2

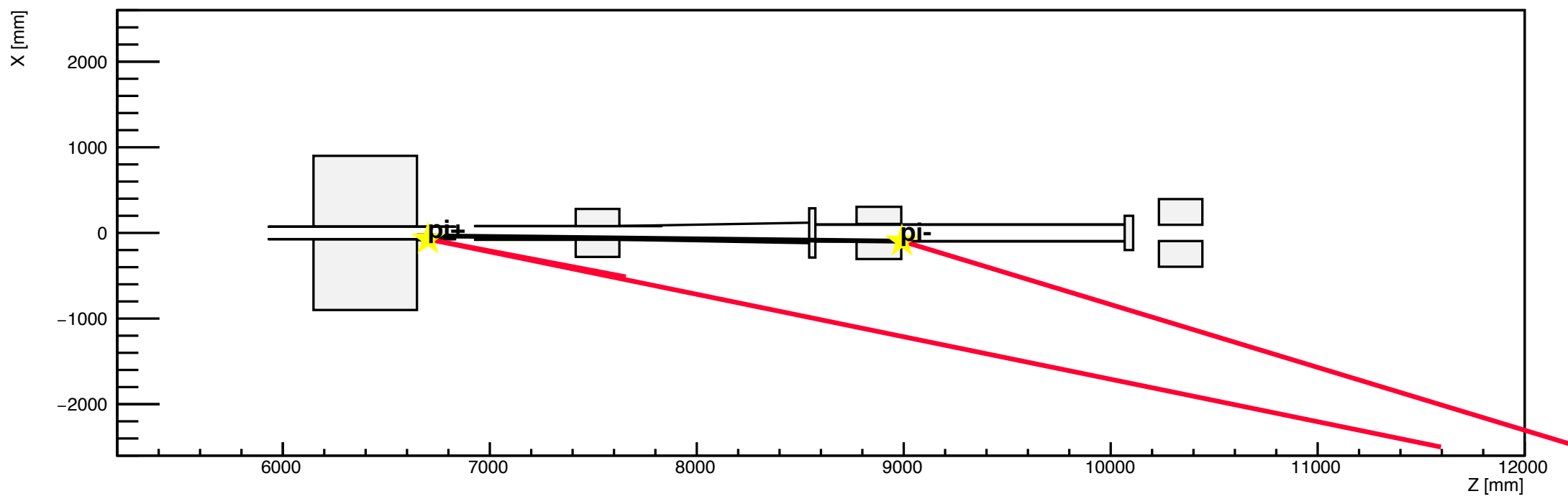

h1

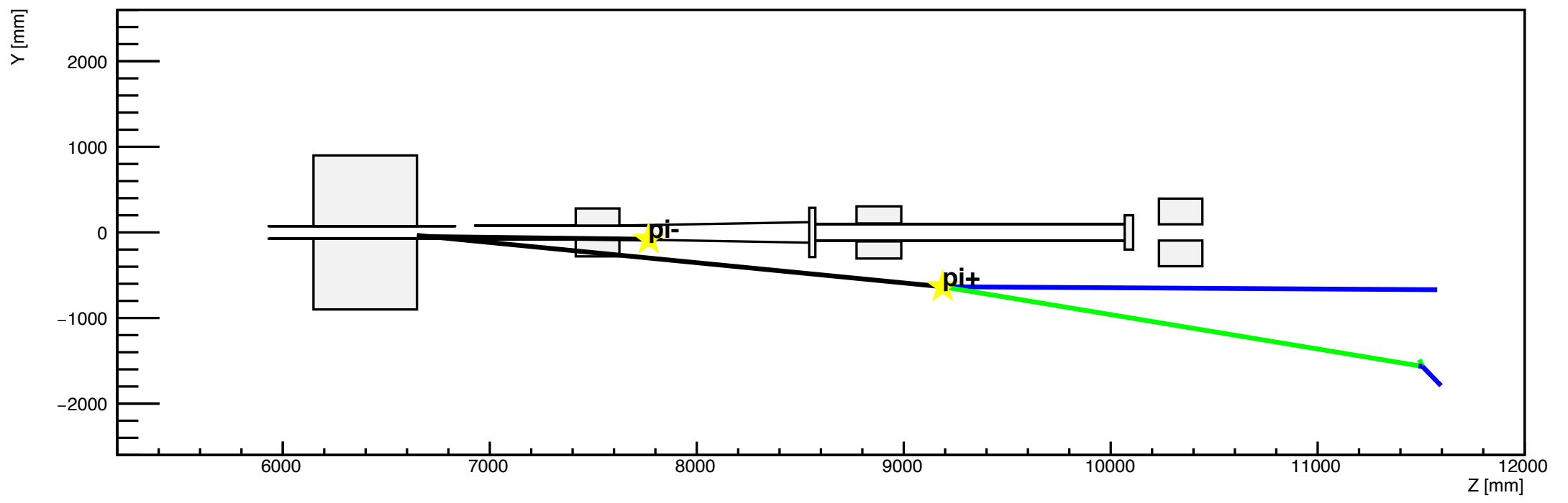

h2

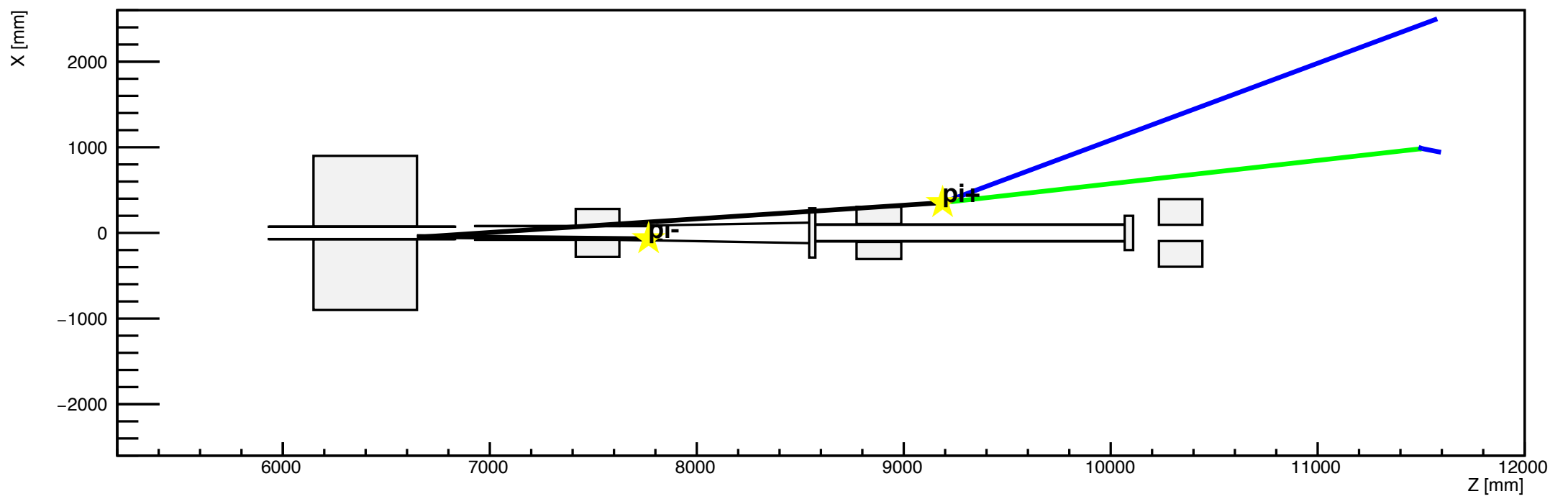

h1

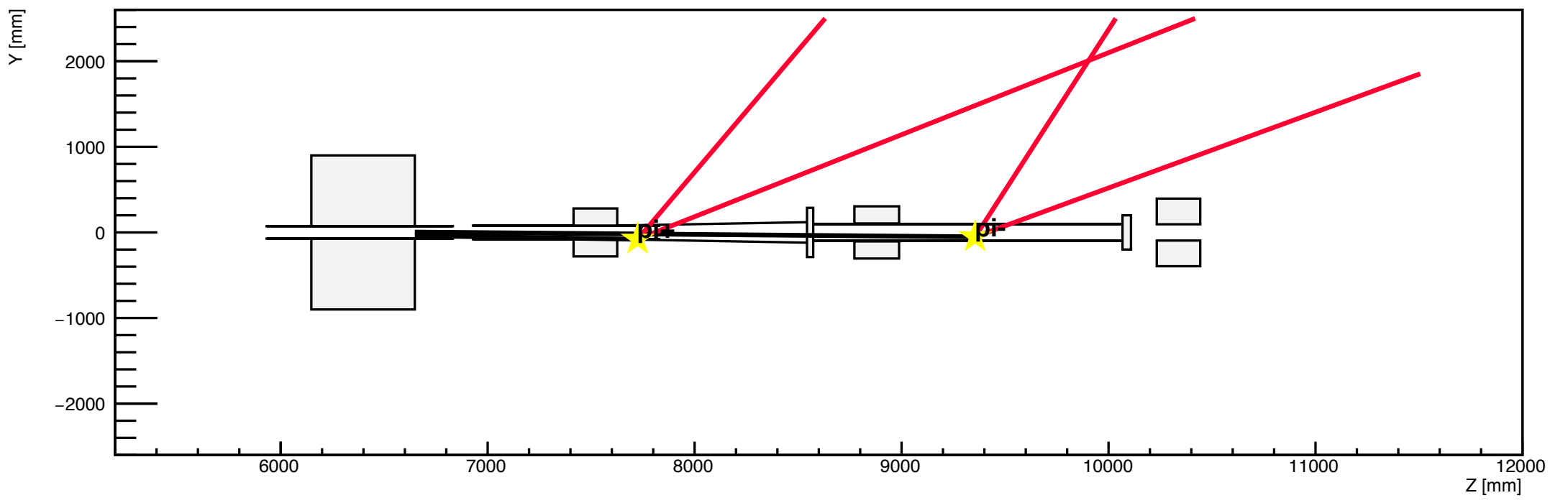

h2

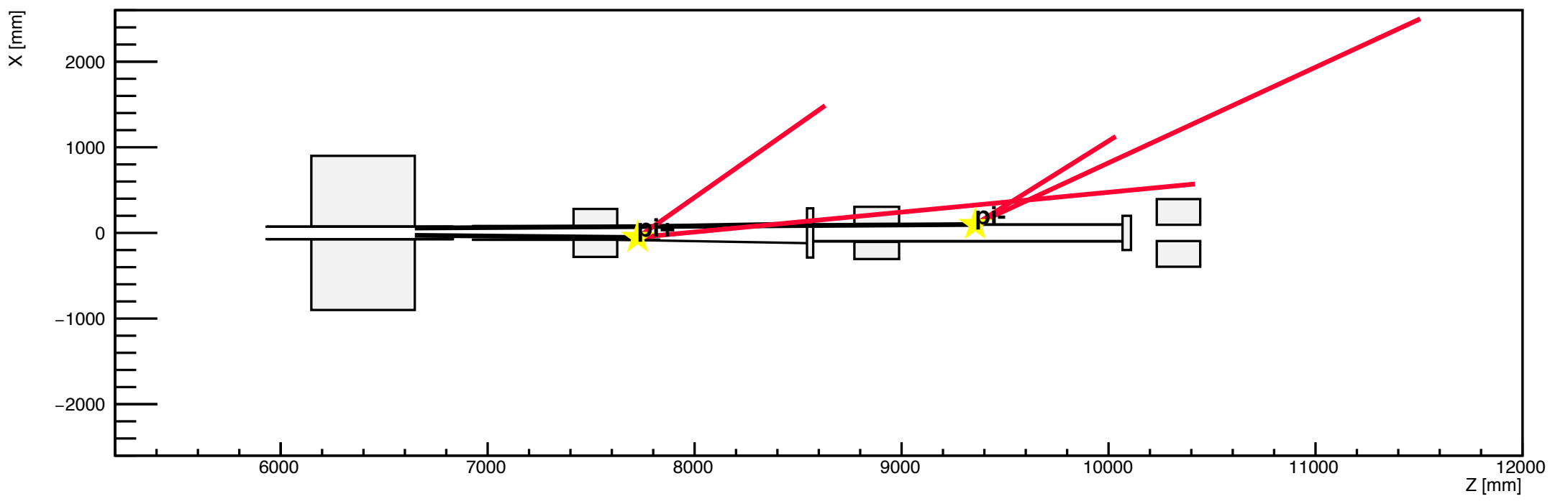

h1

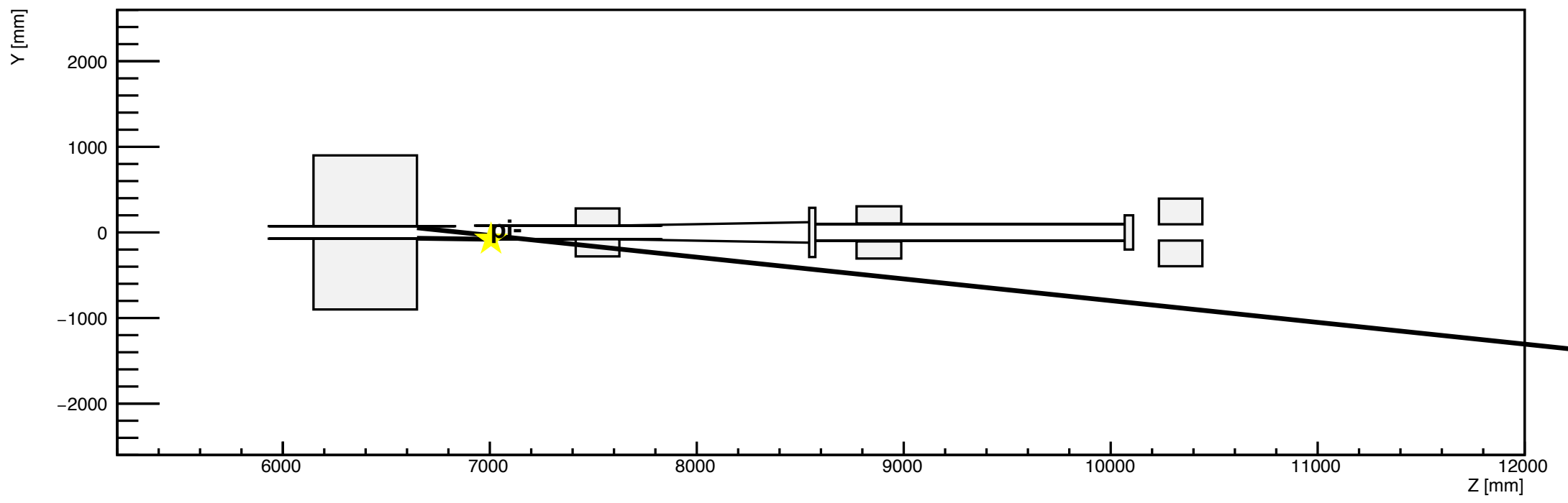

h2

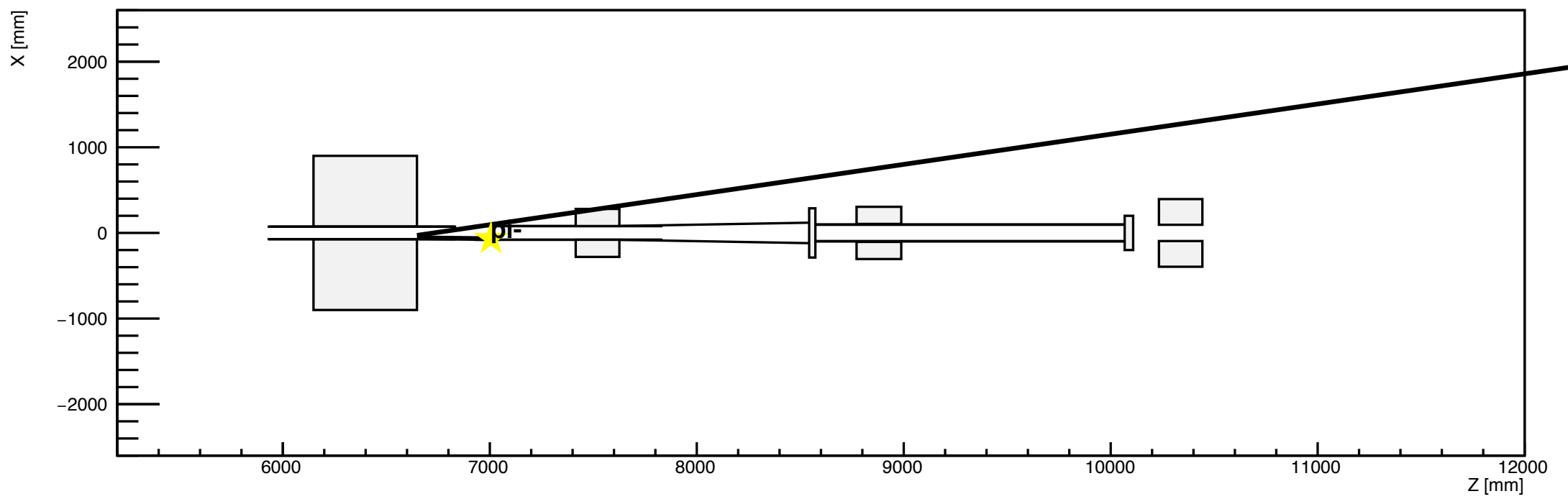

h1

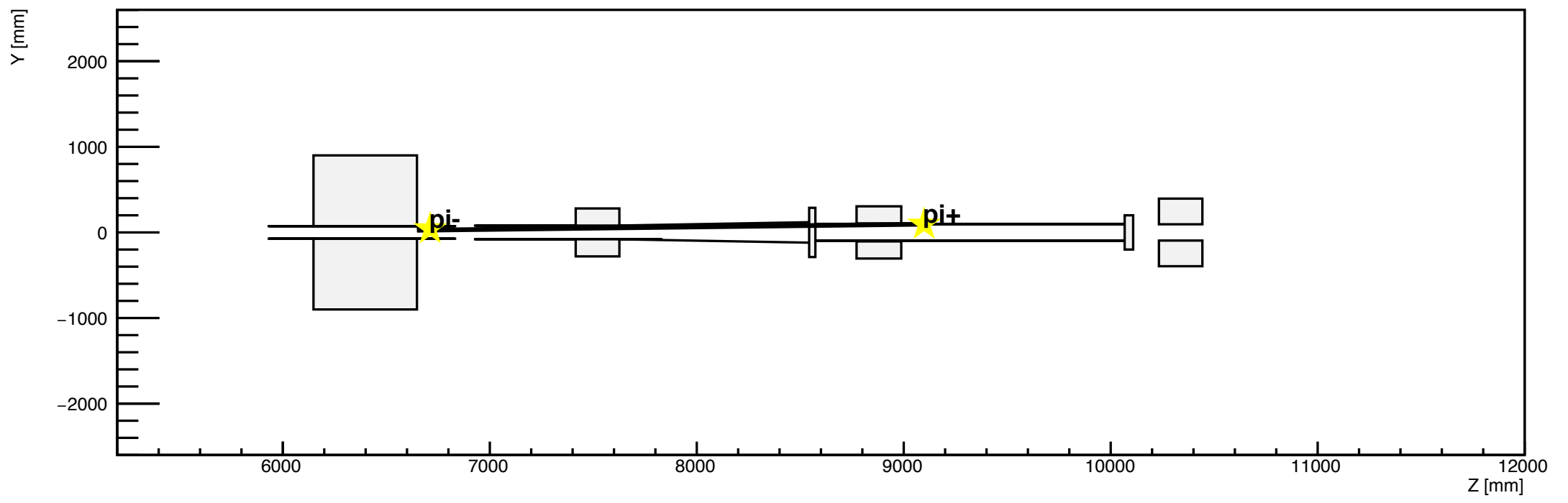

h2

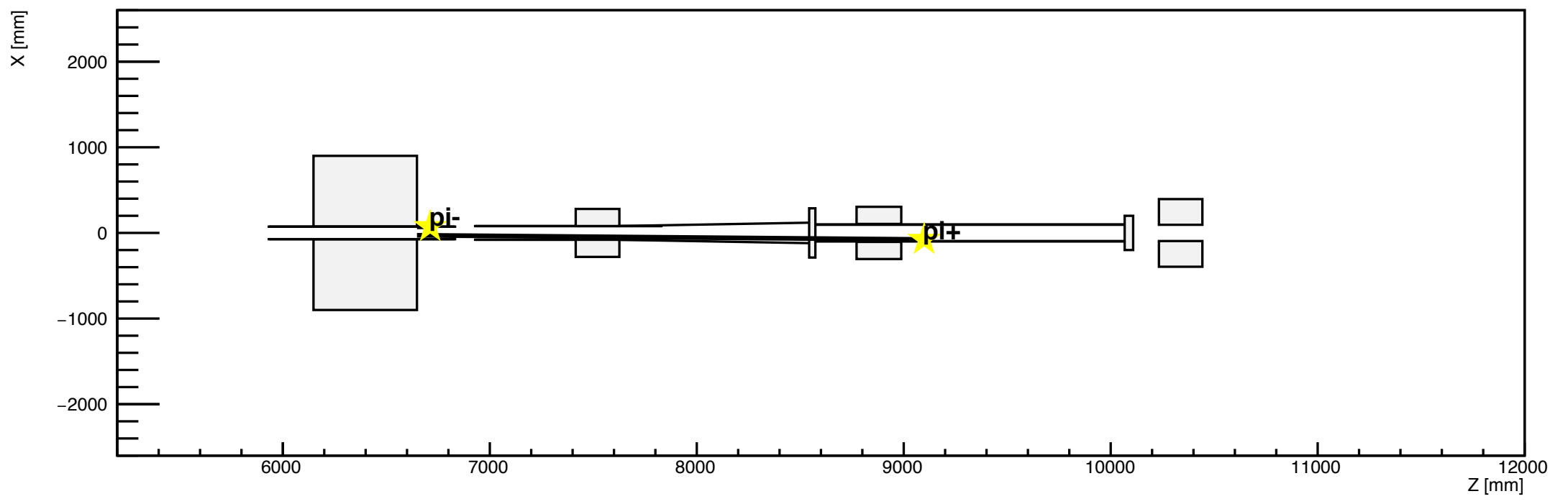

h1

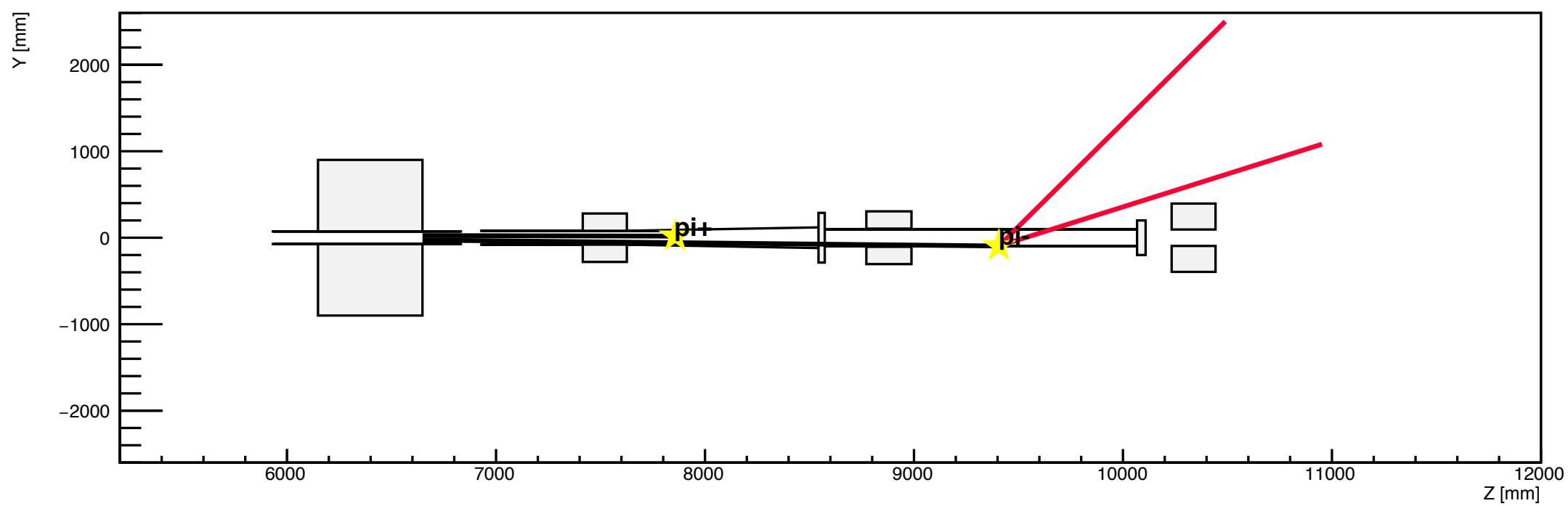

h2

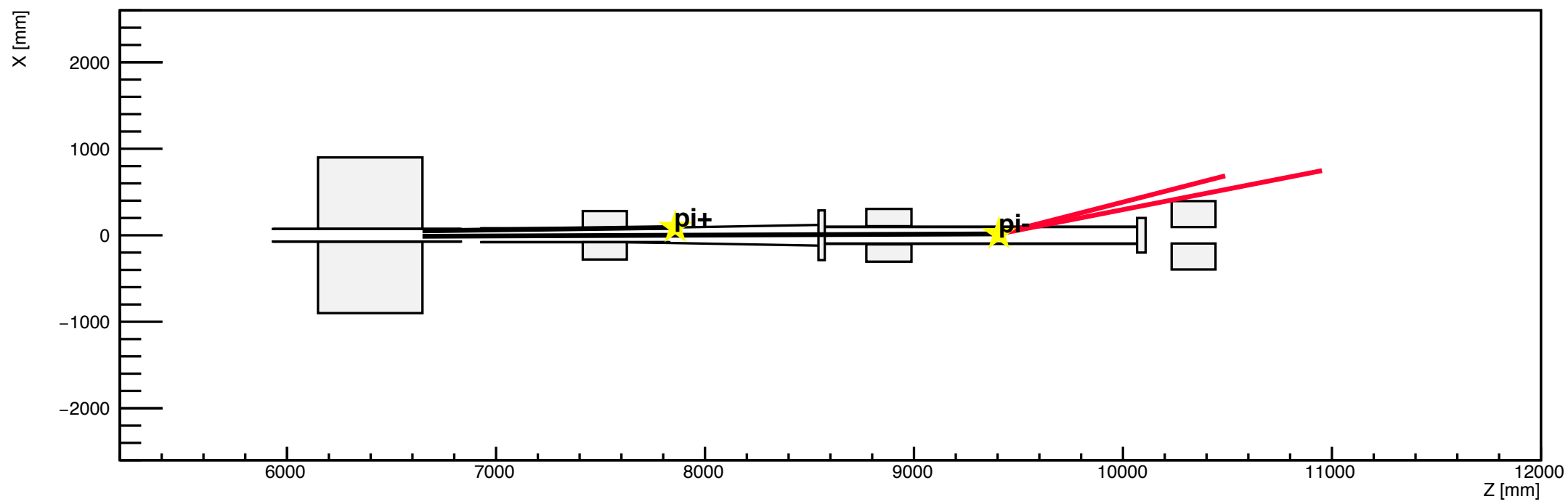

h1

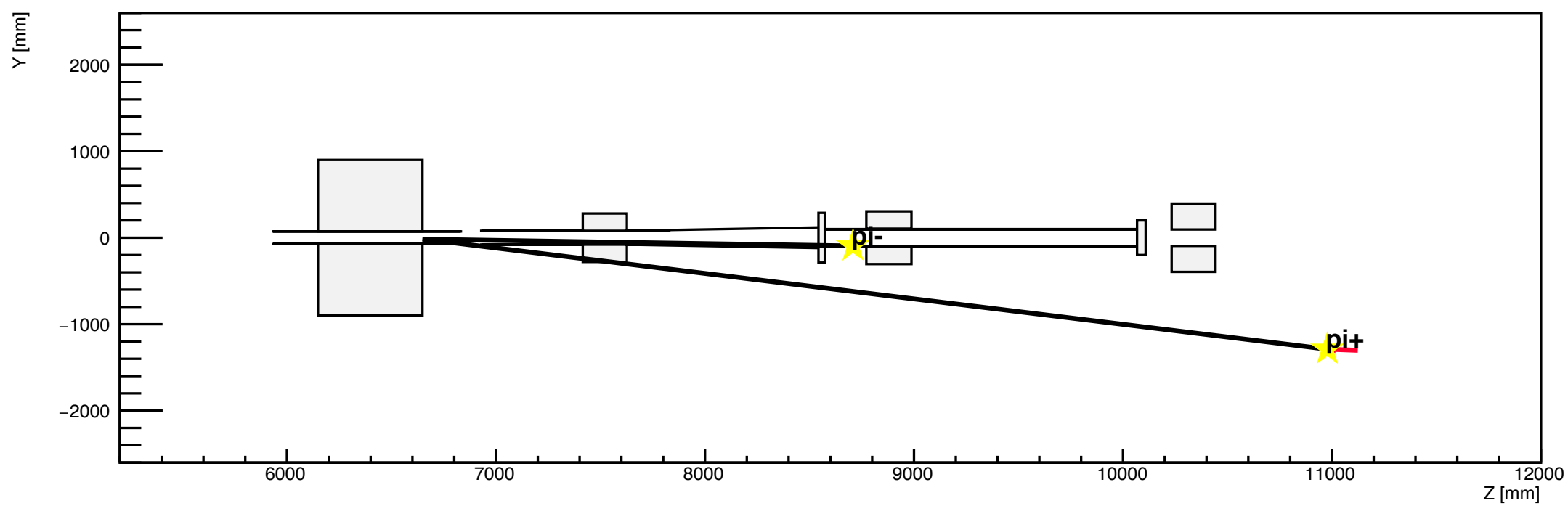

h2

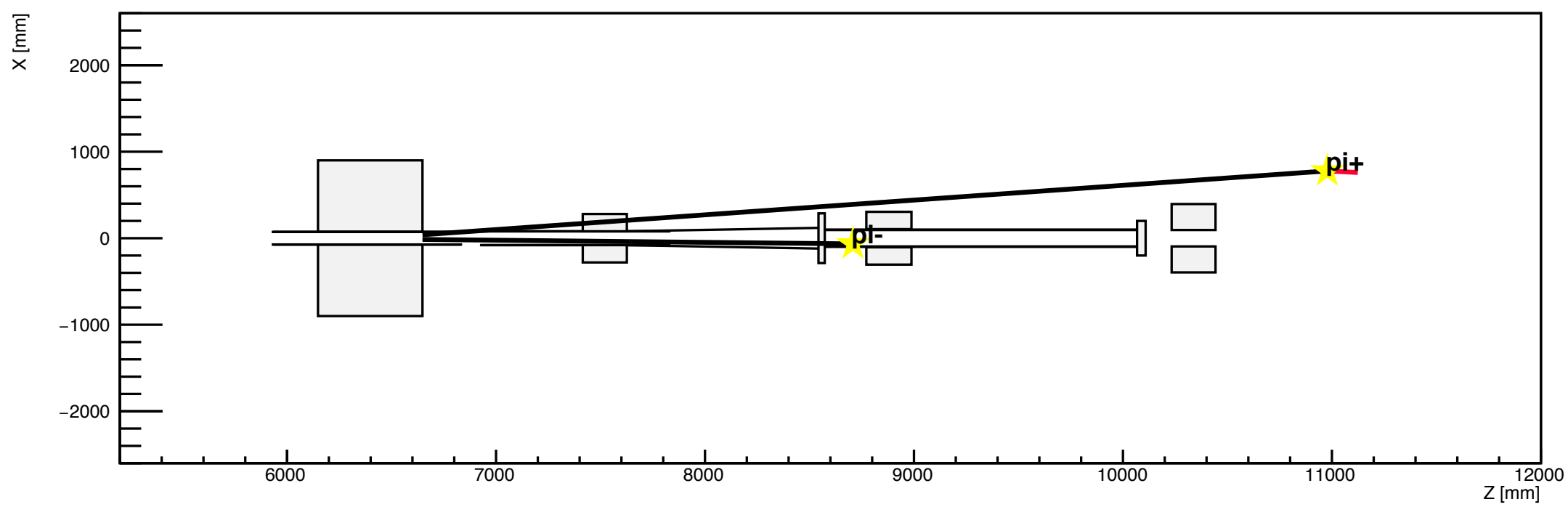

h1

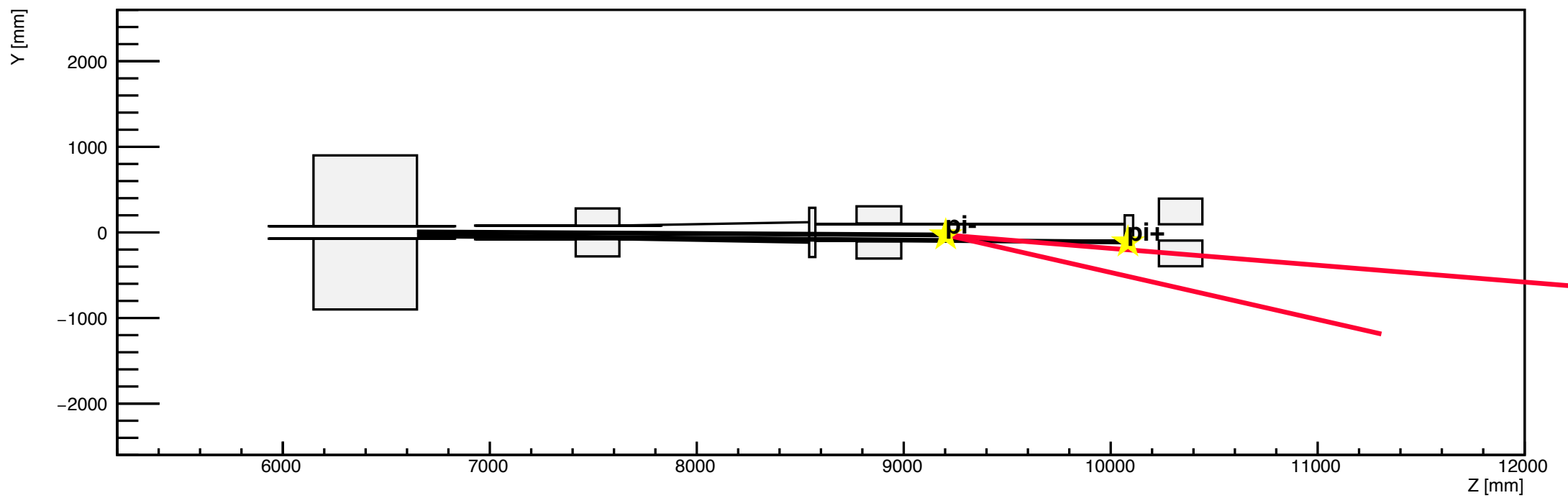

h2

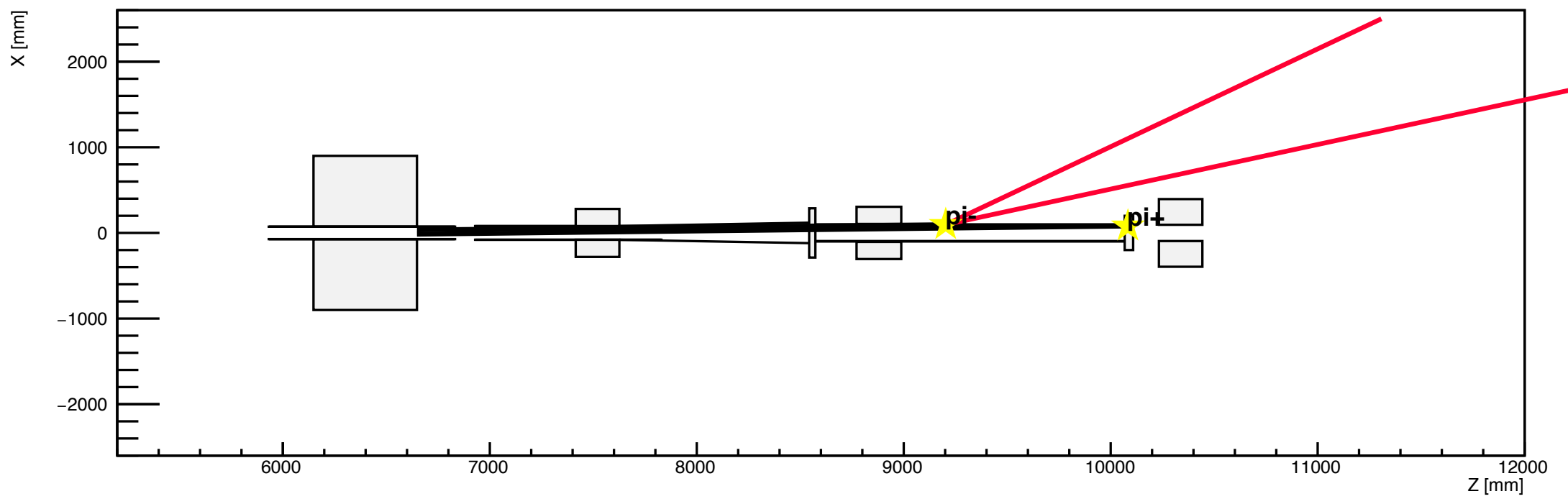

h1

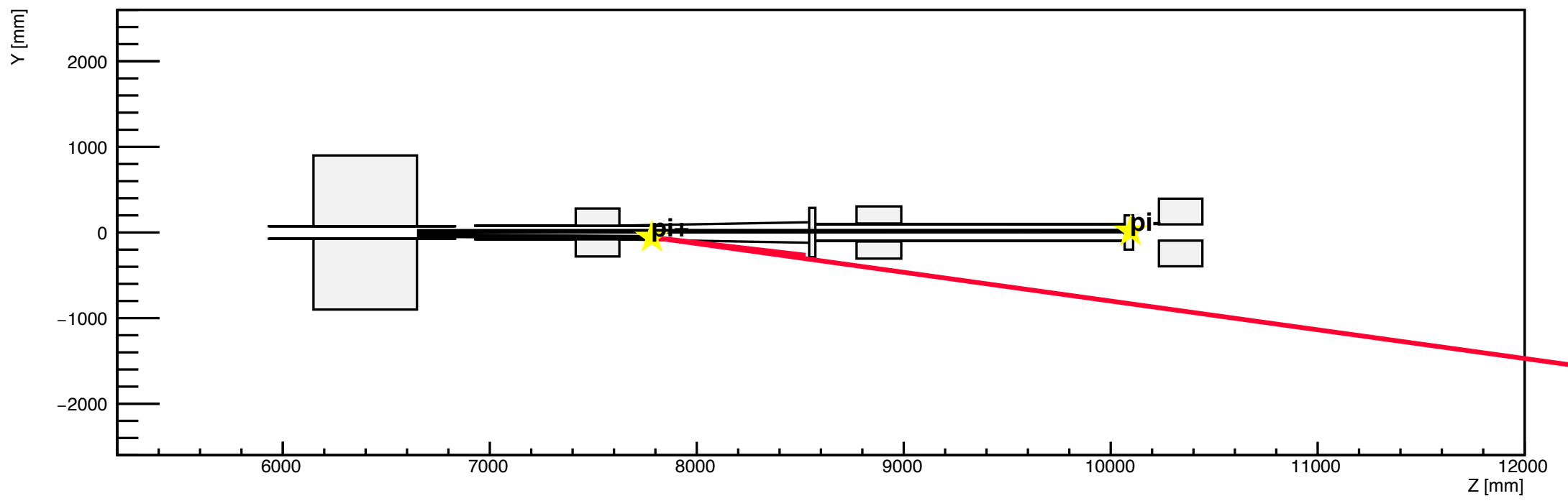

h2

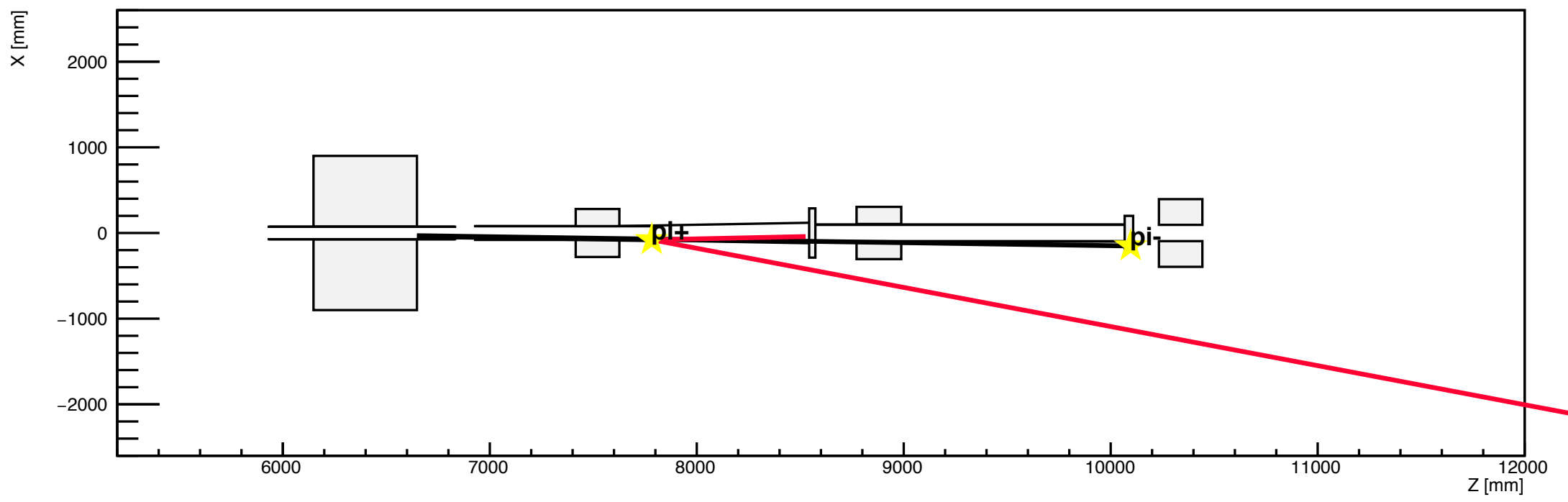

h1

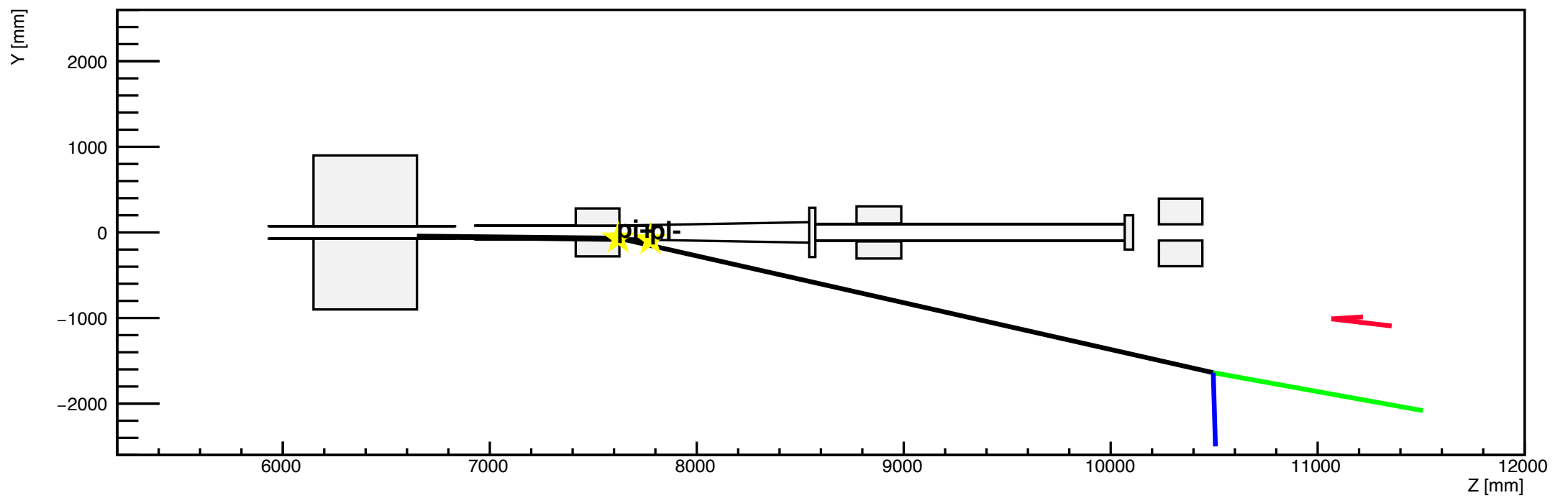

h2

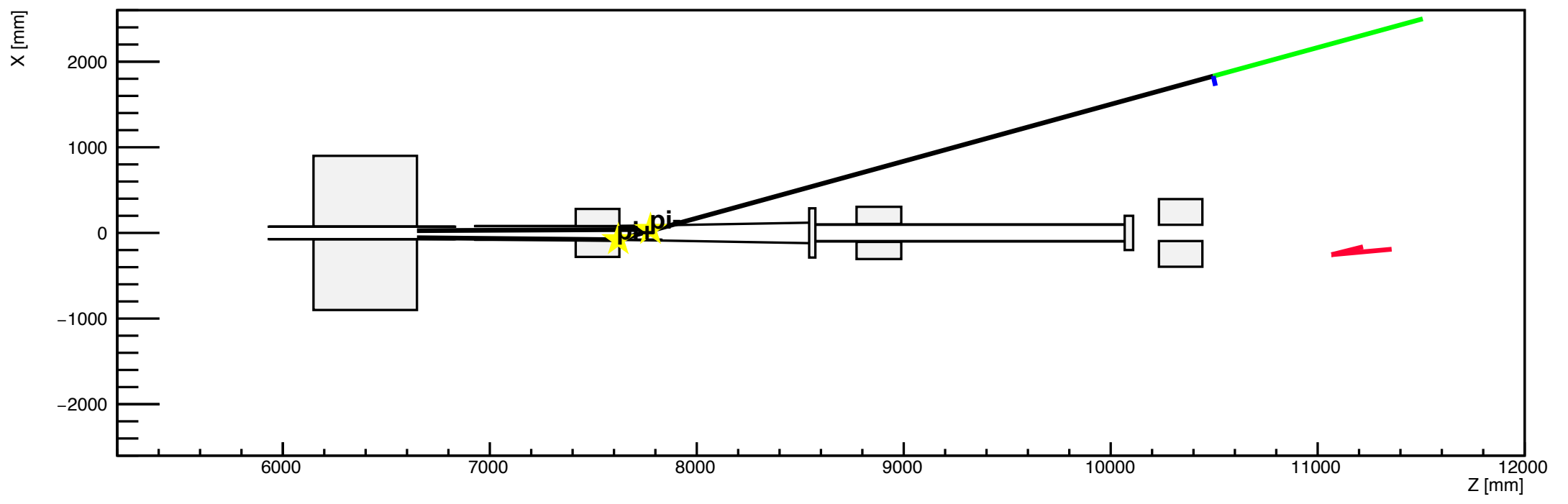

h1

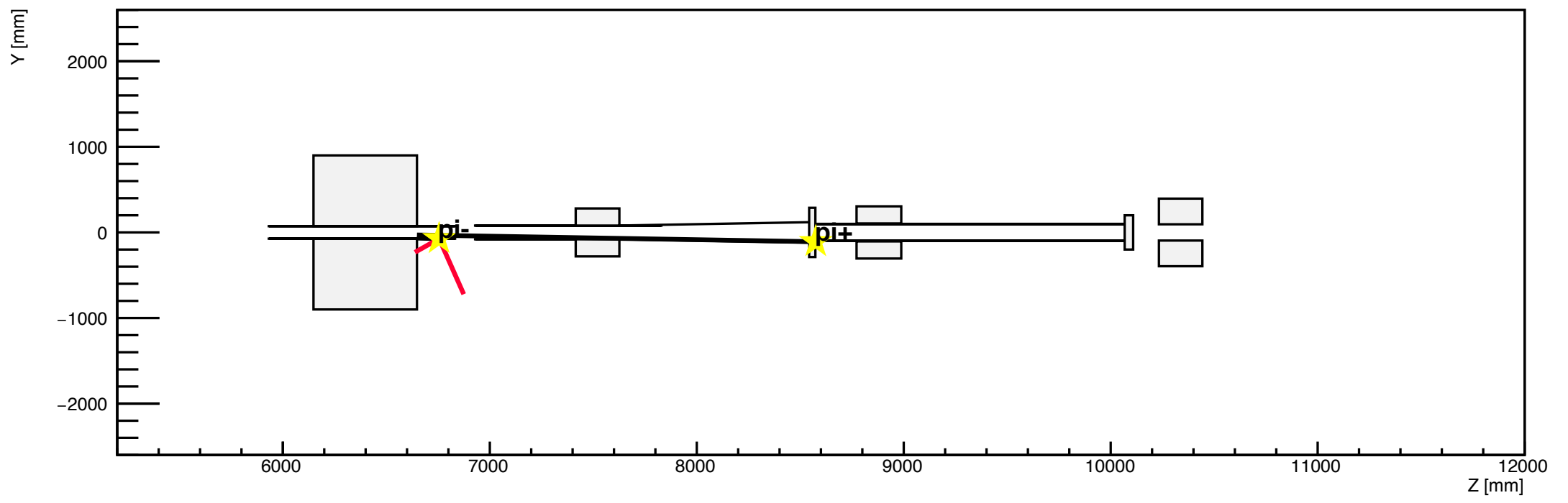

h2

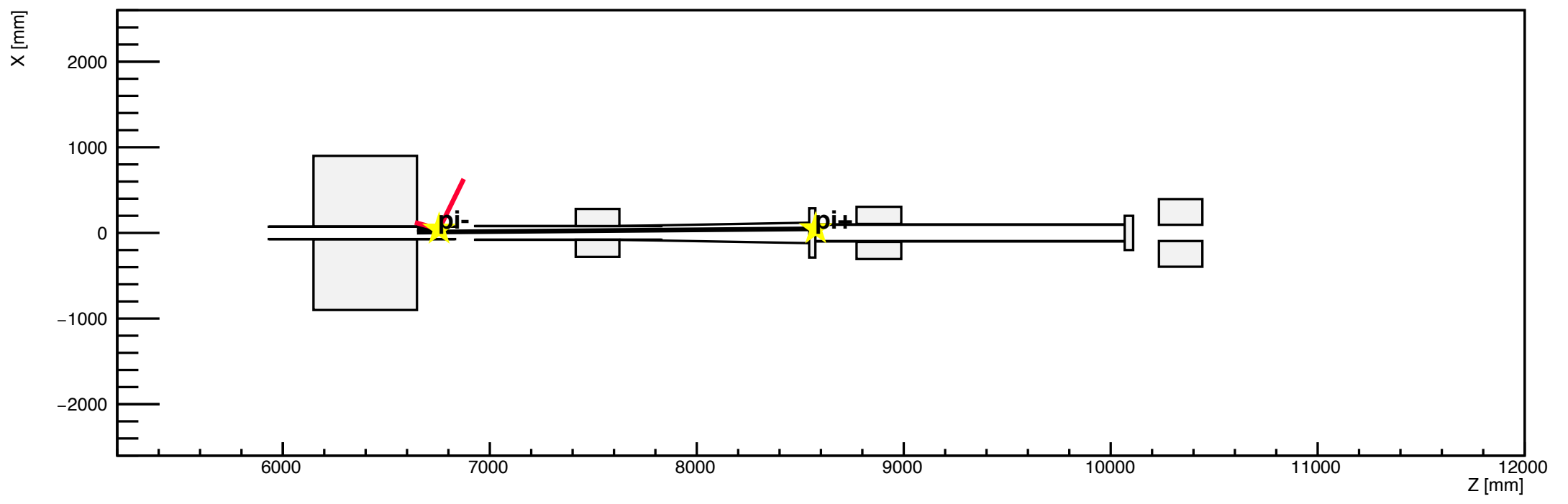

h1

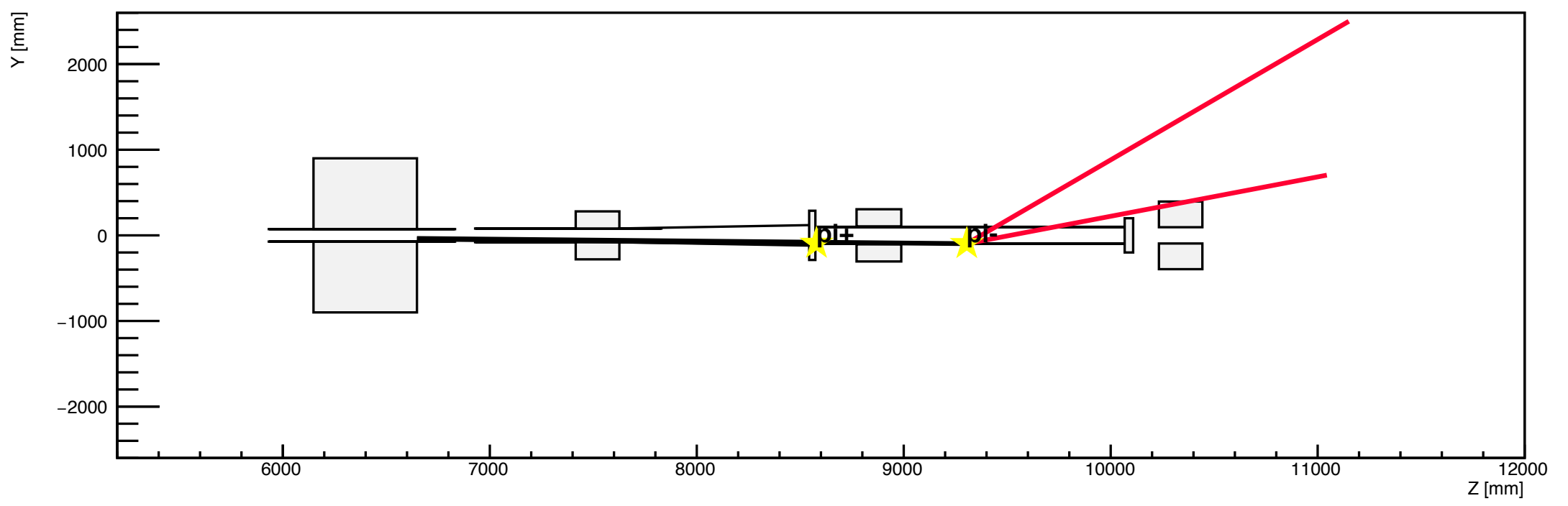

h2

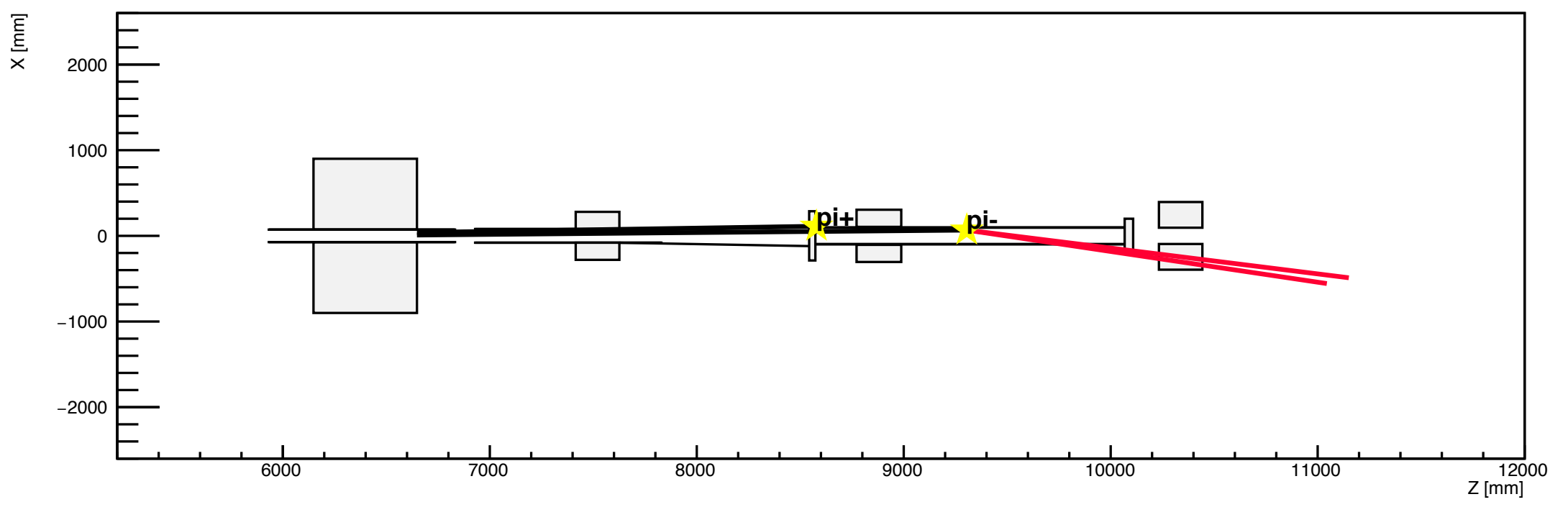

h1

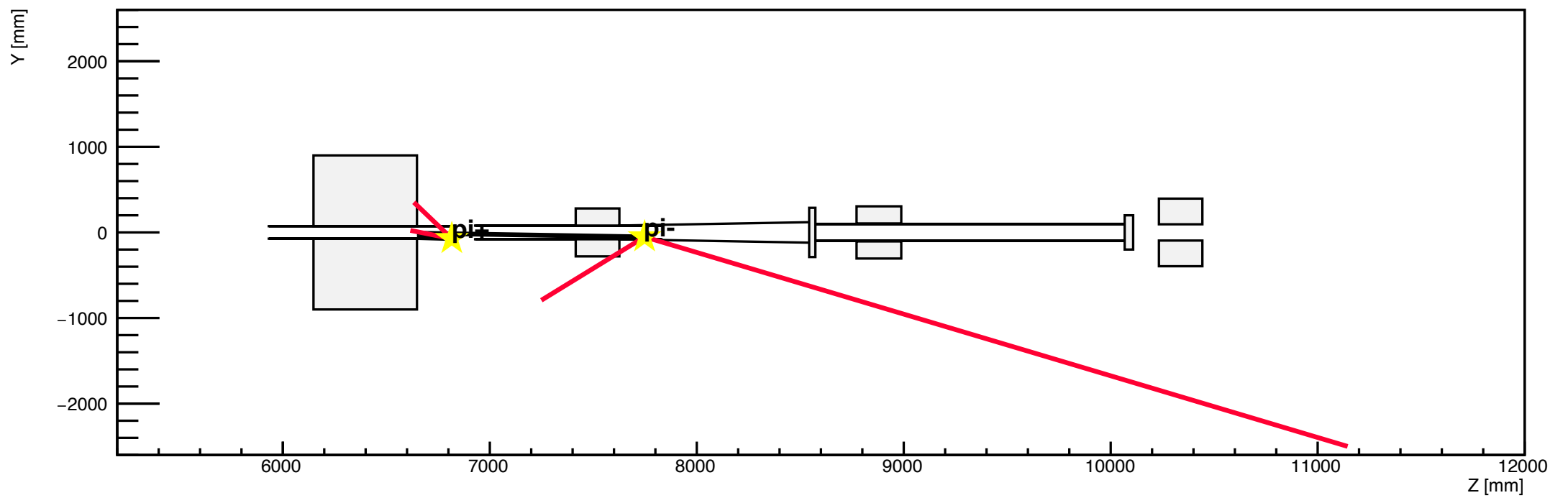

h2

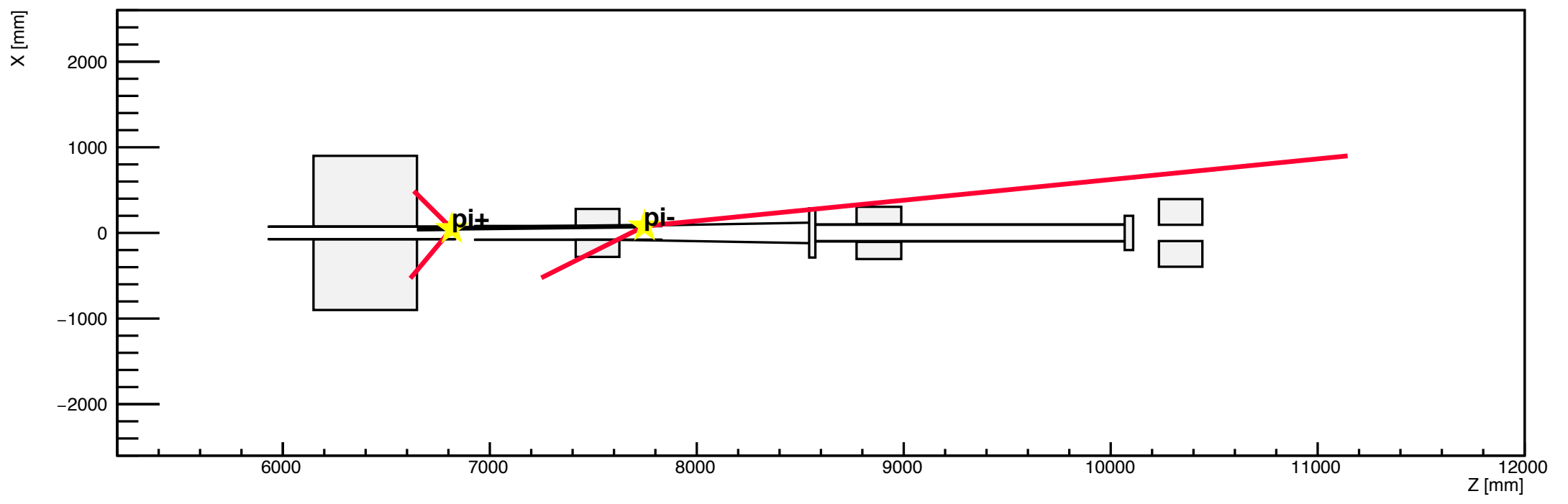

h1

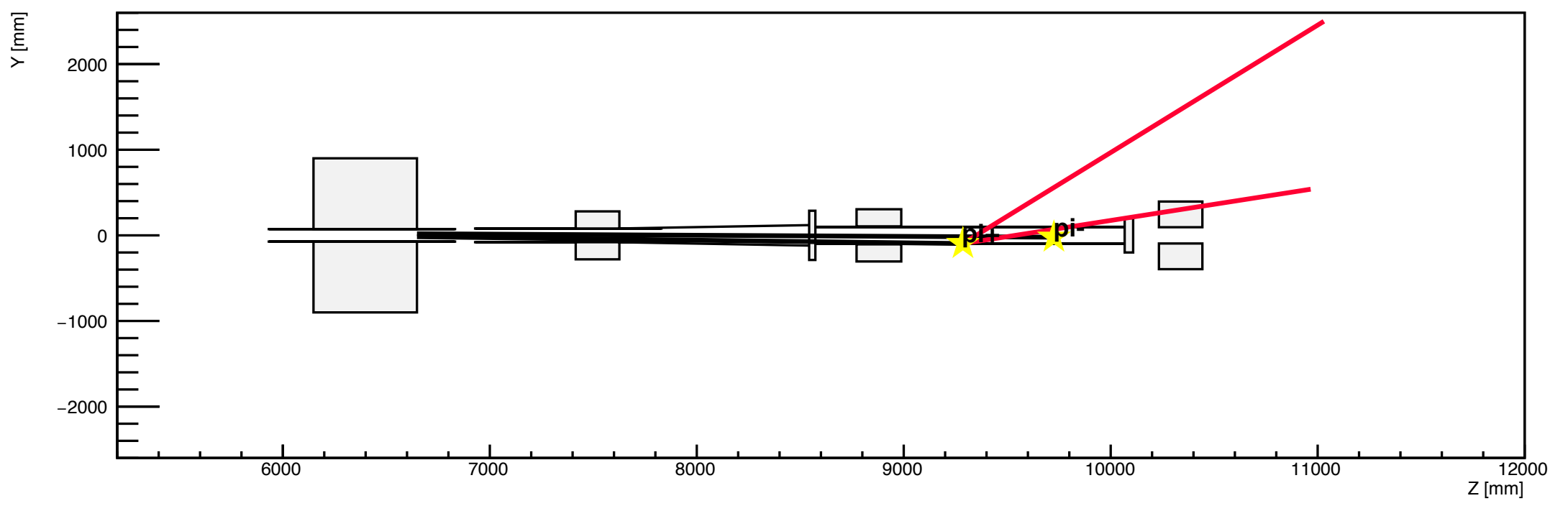

h2

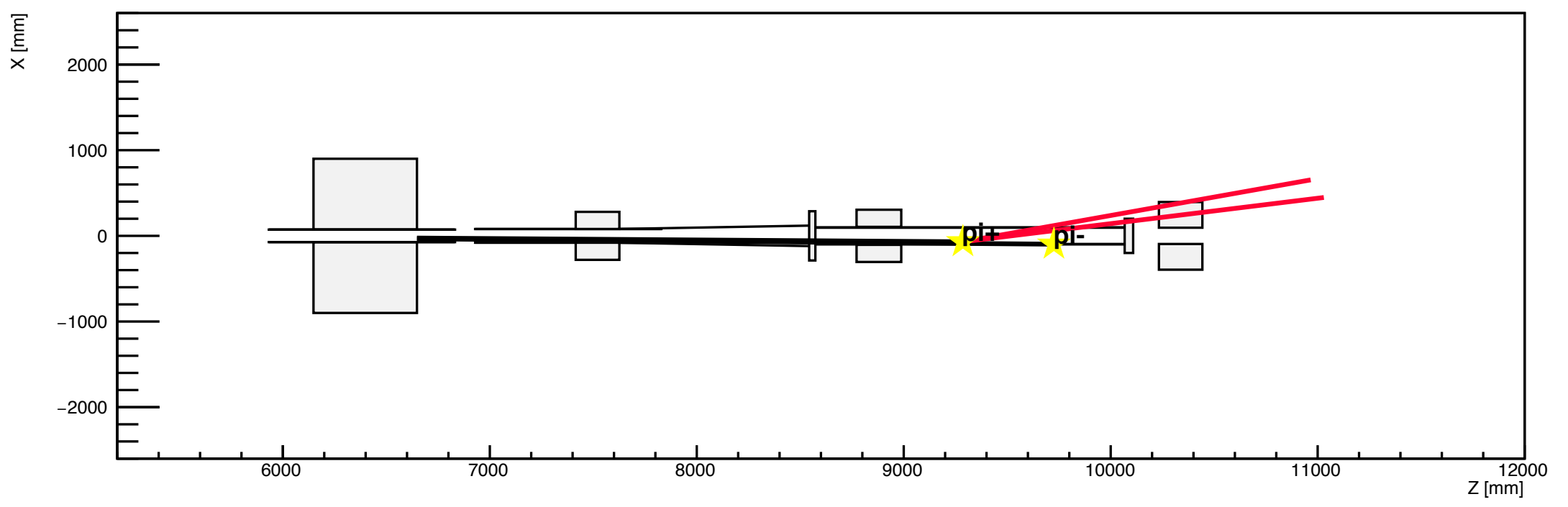

h1

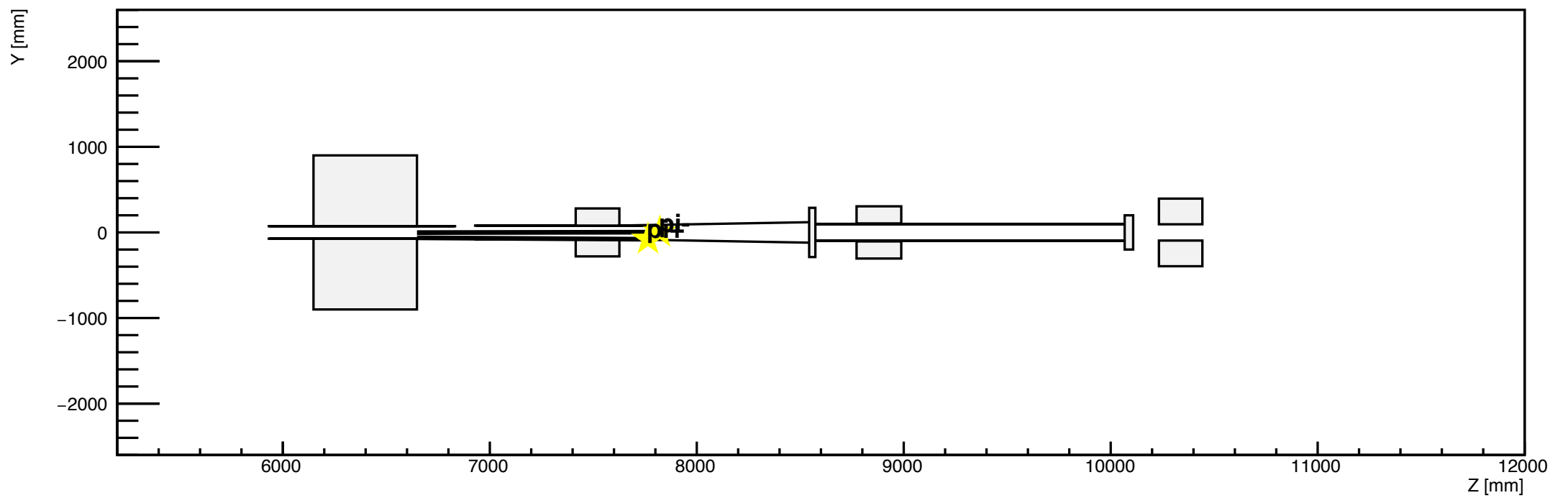

h2

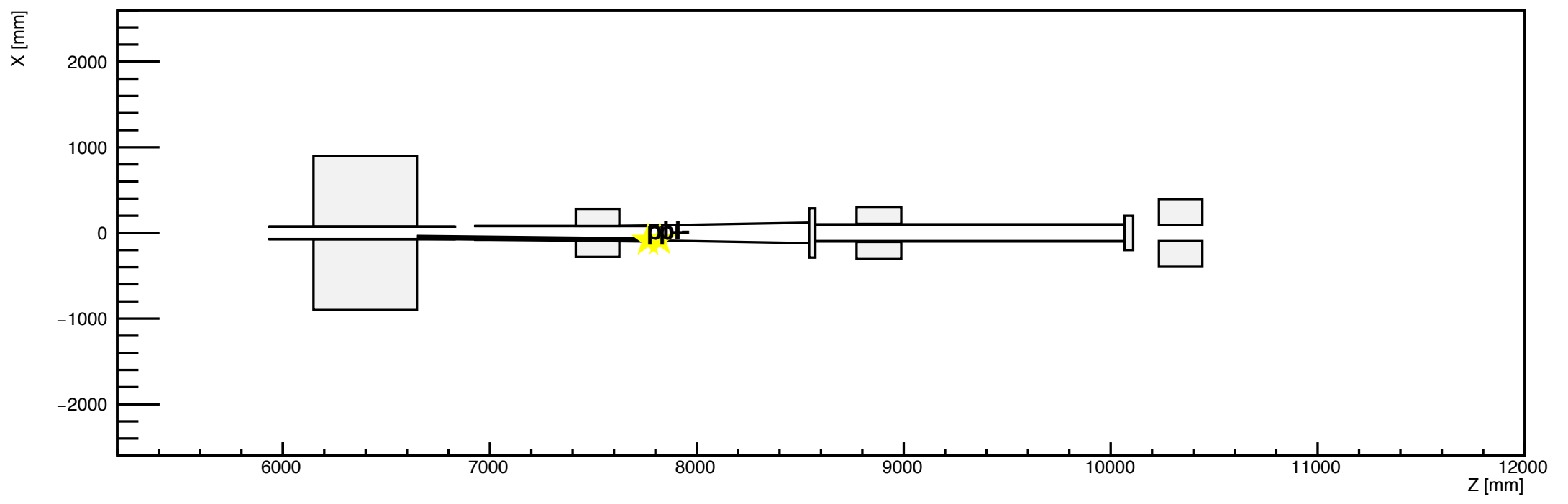

h1

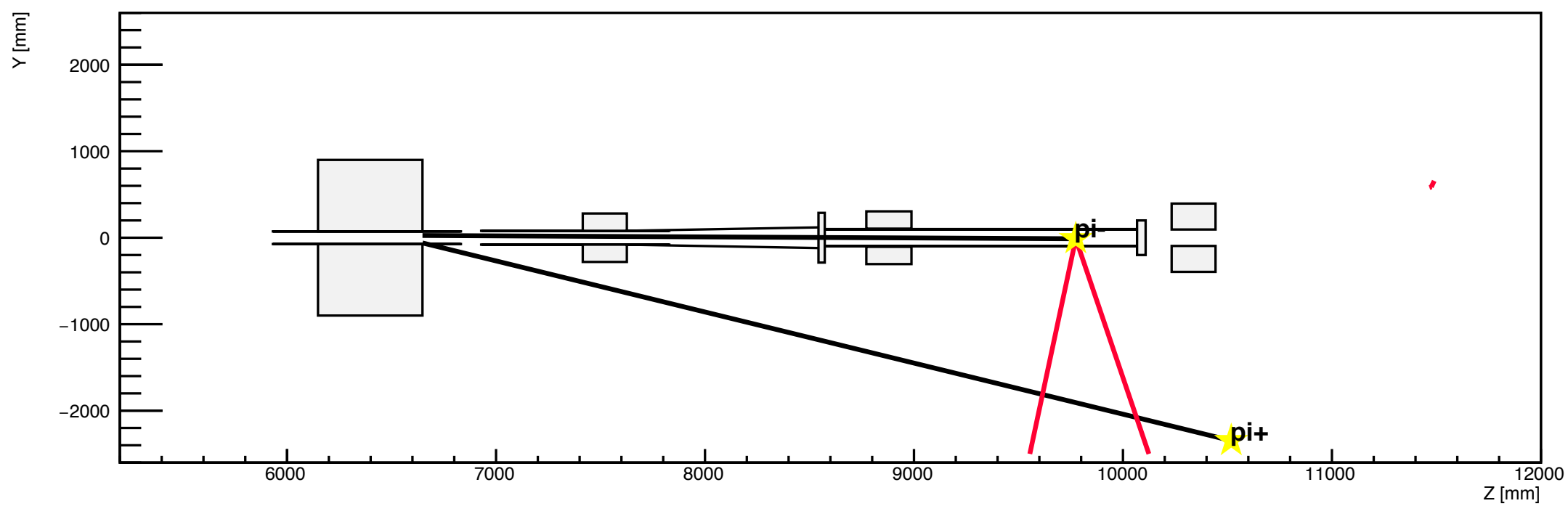

h2

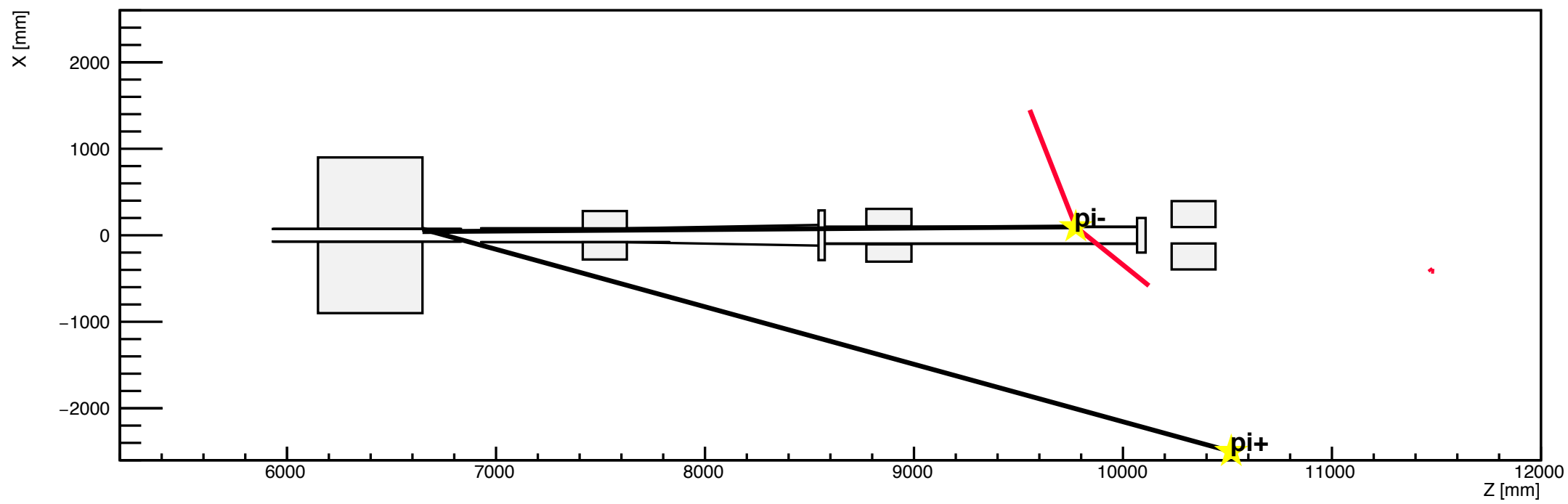

h1

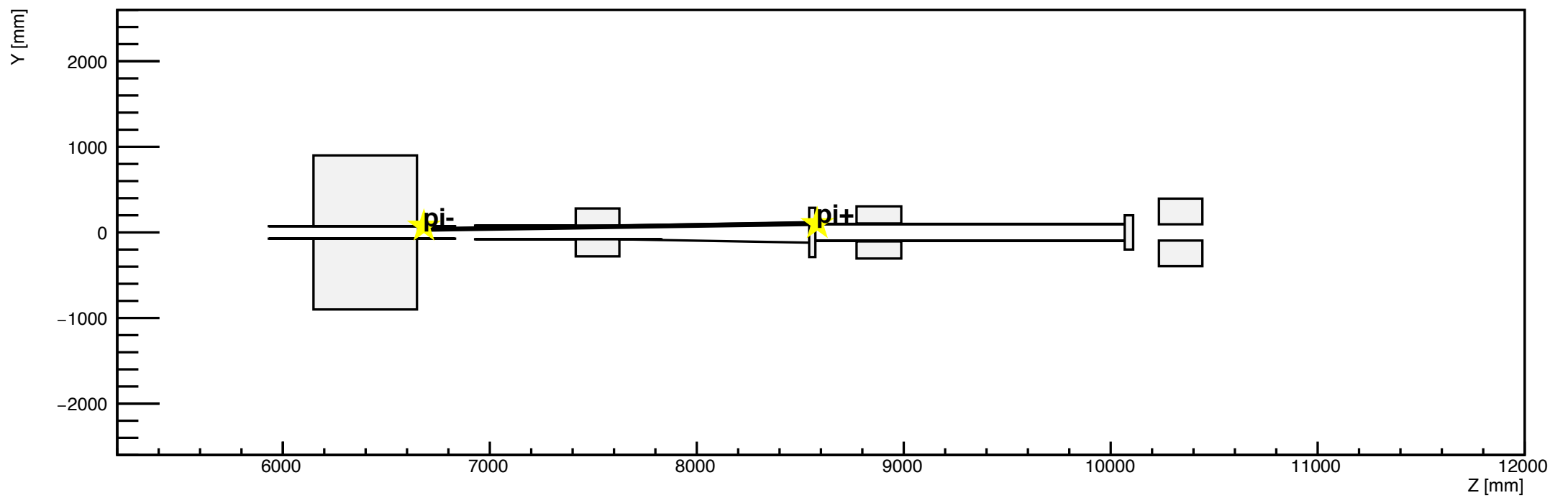

h2

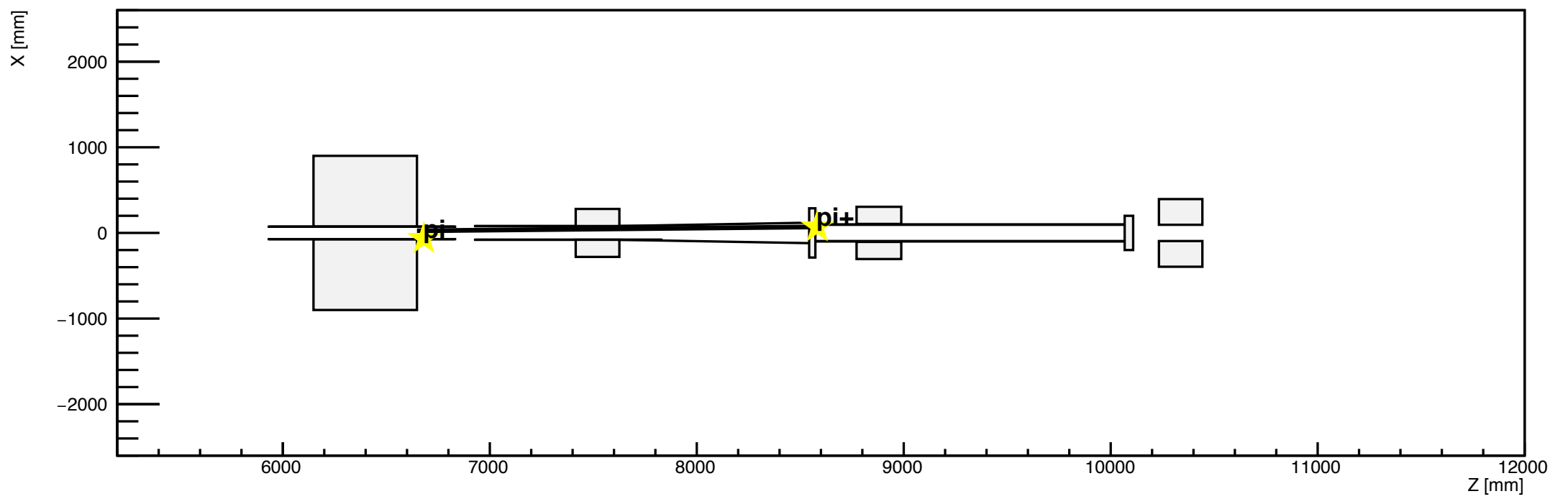

h1

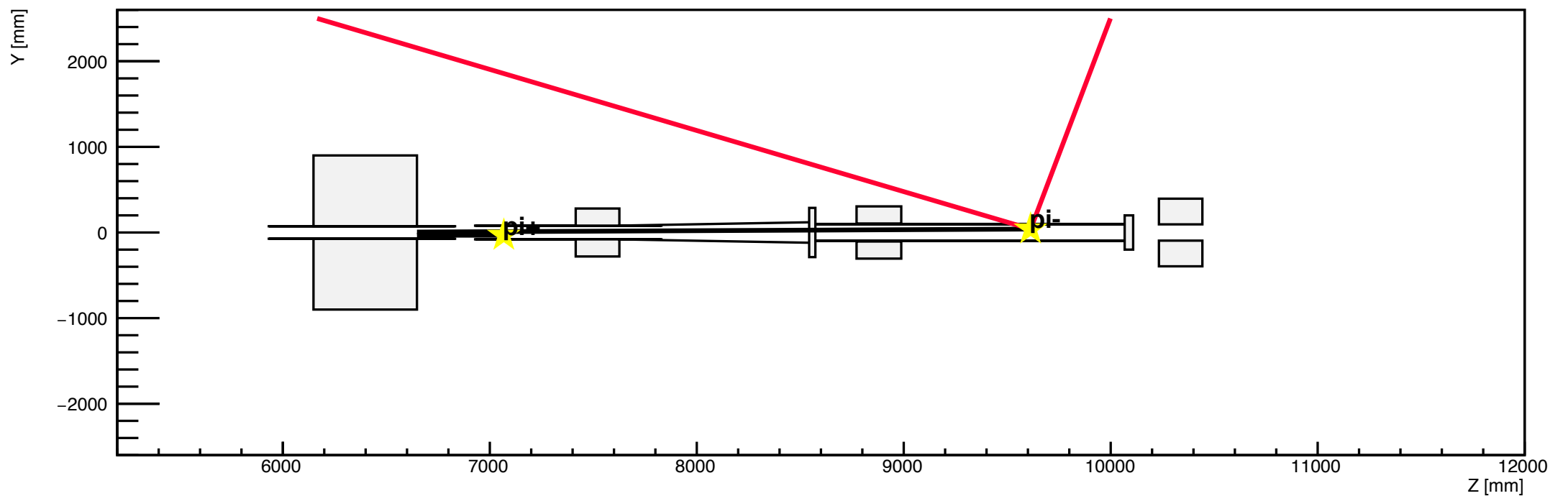

h2

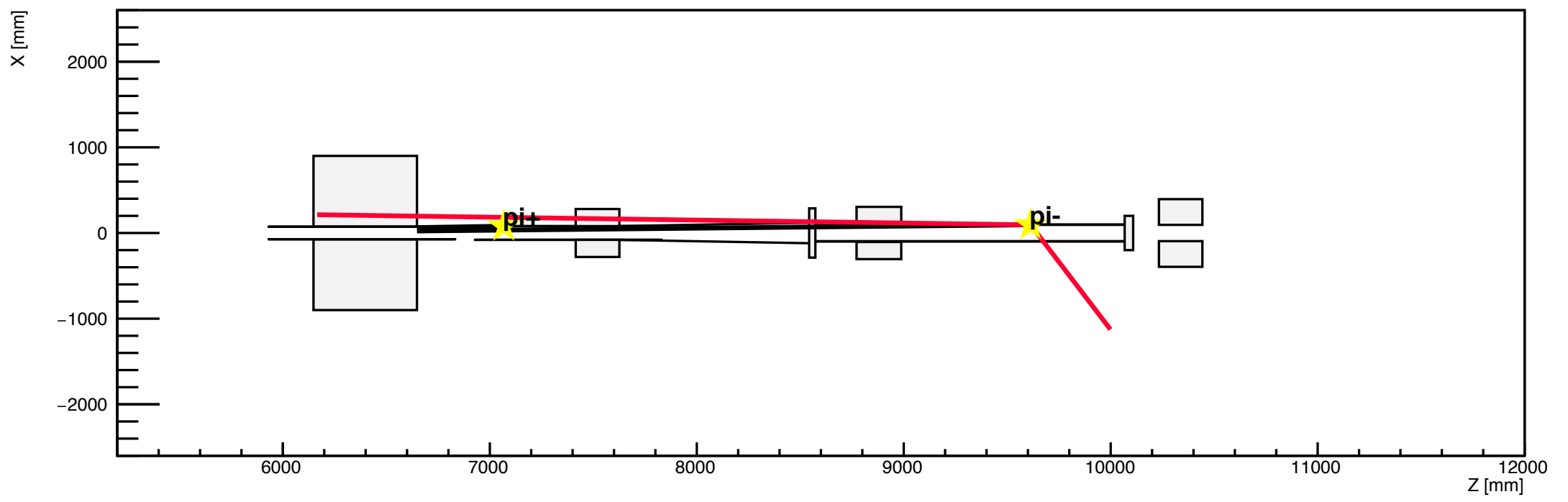

h1

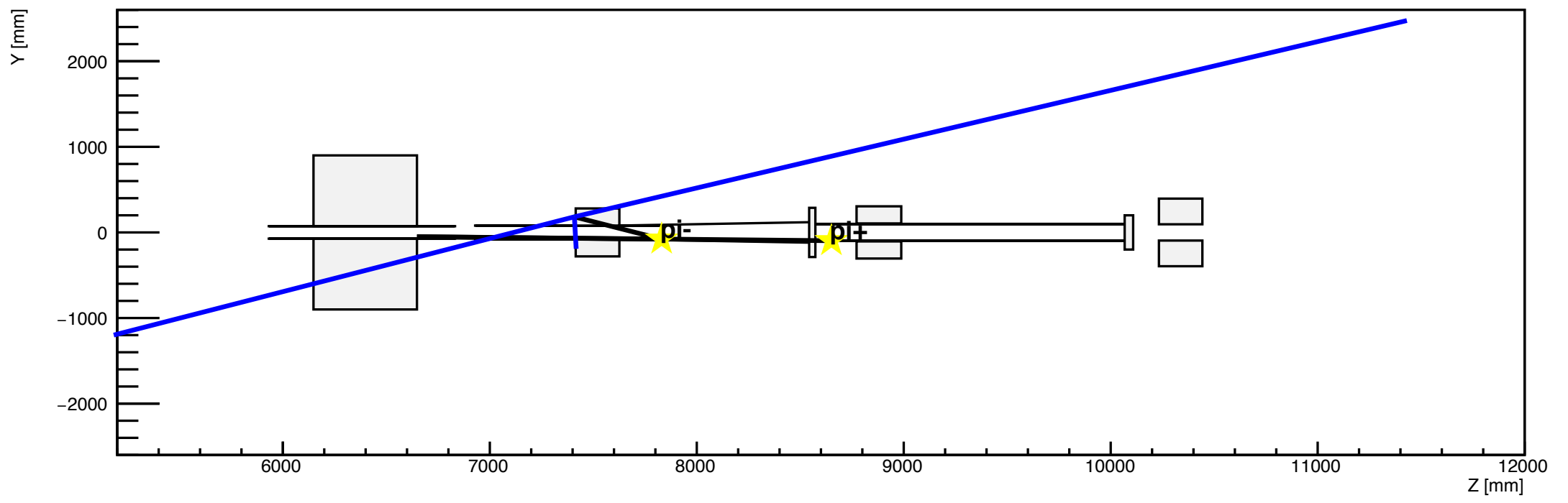

h2

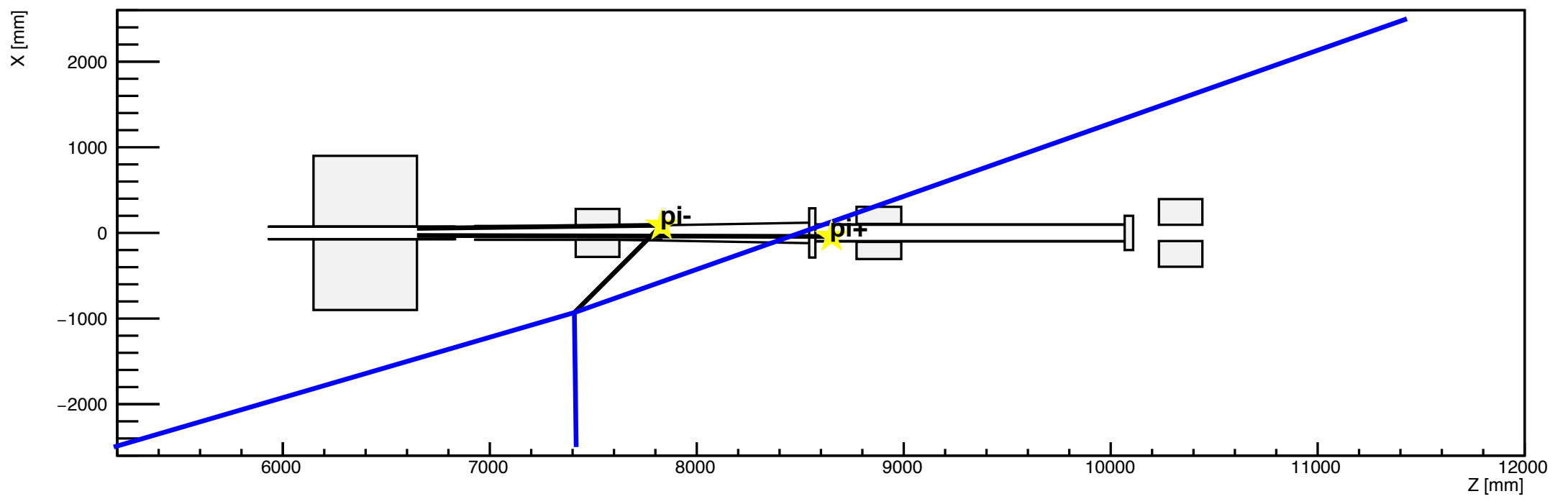

h1

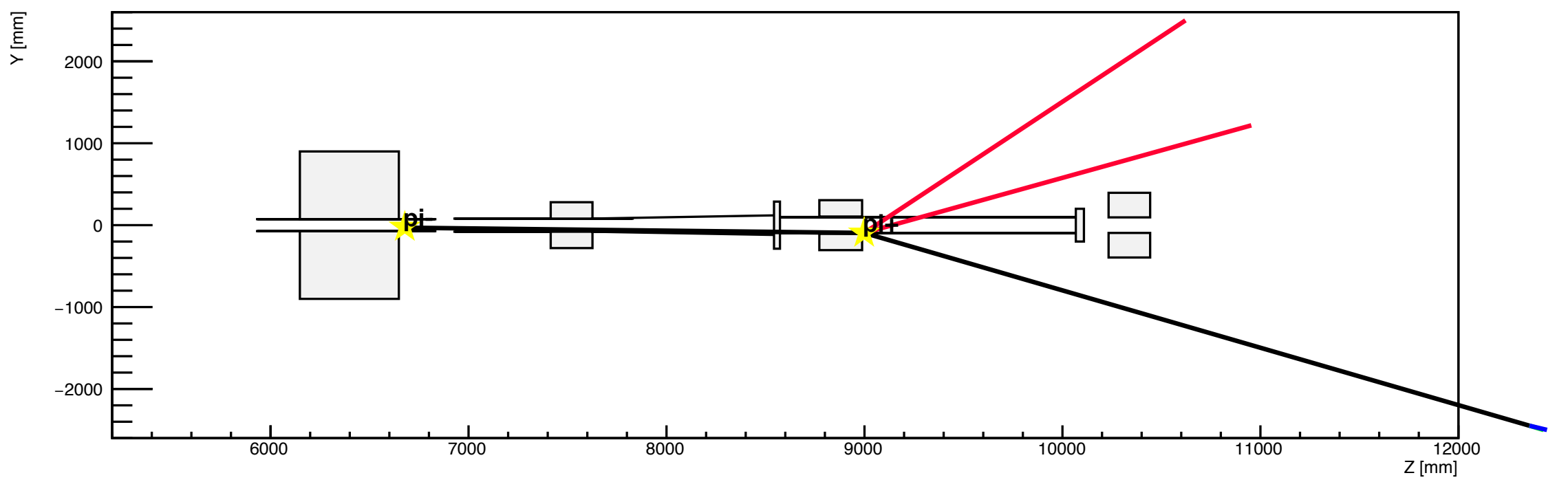

h2

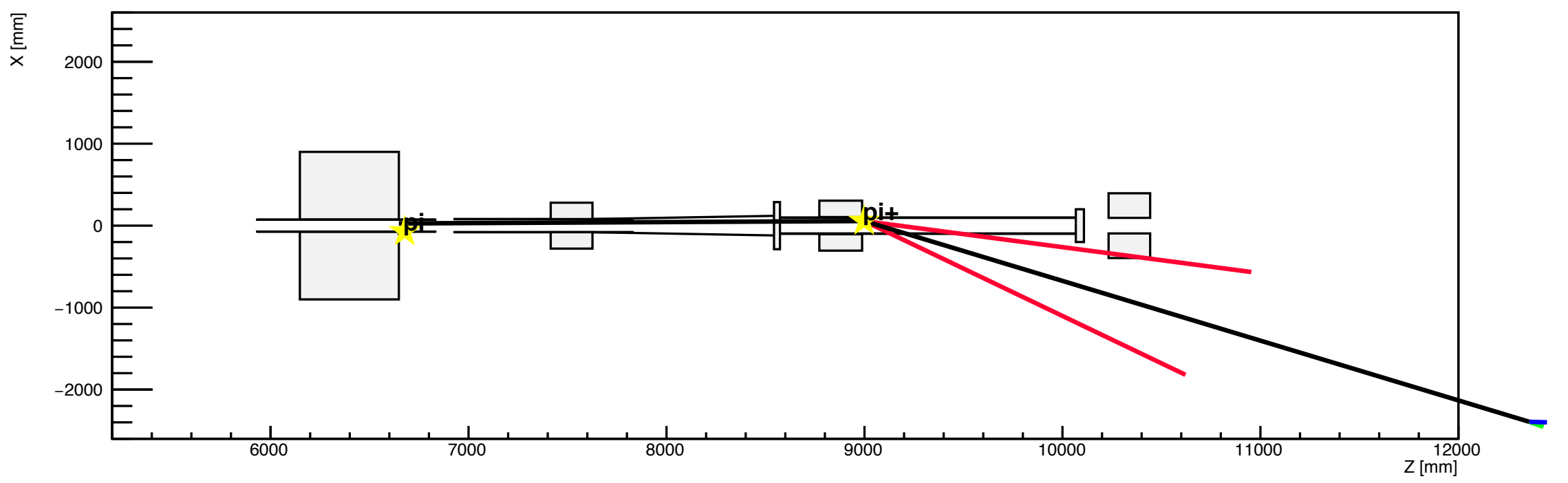

h1

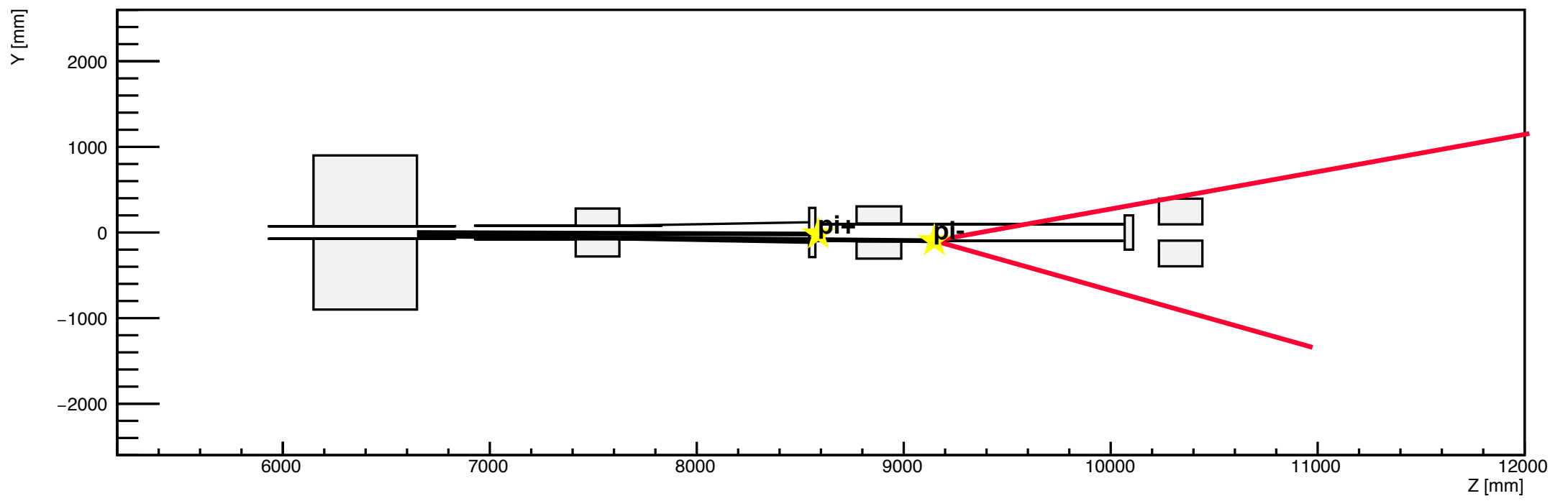

h2

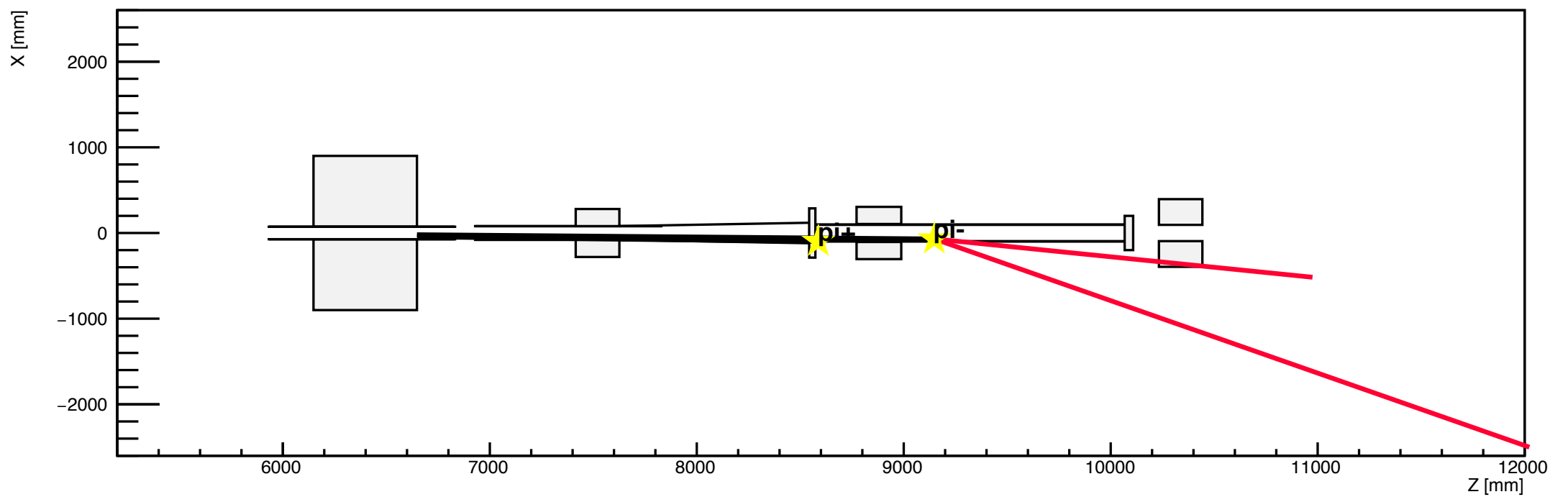

h1

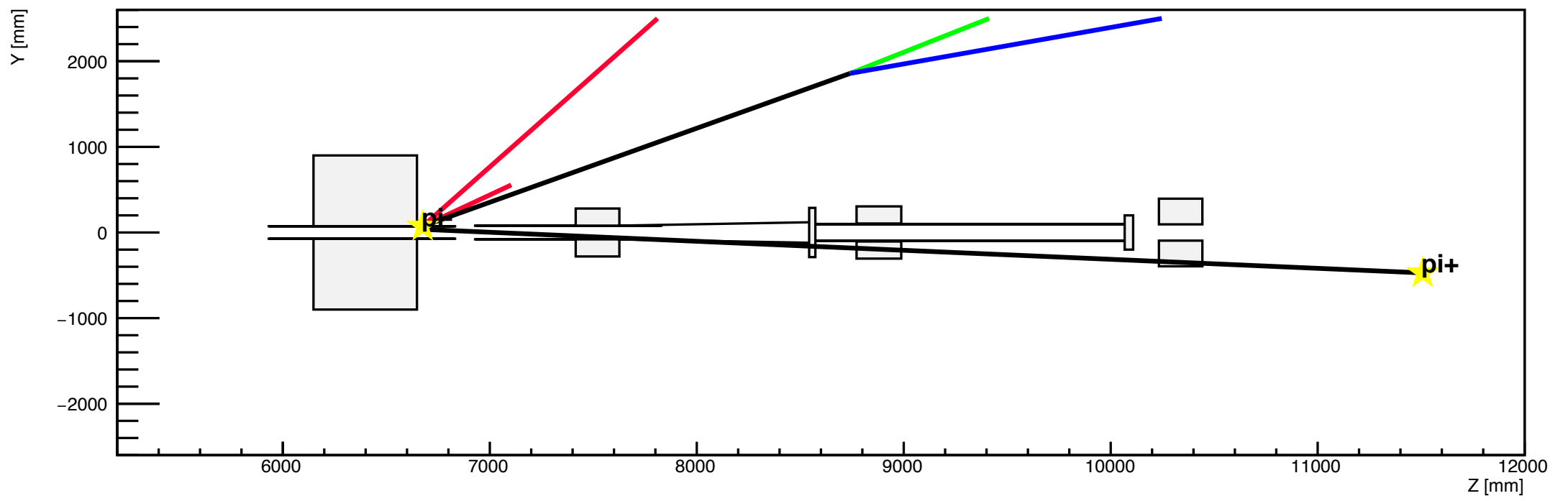

h2

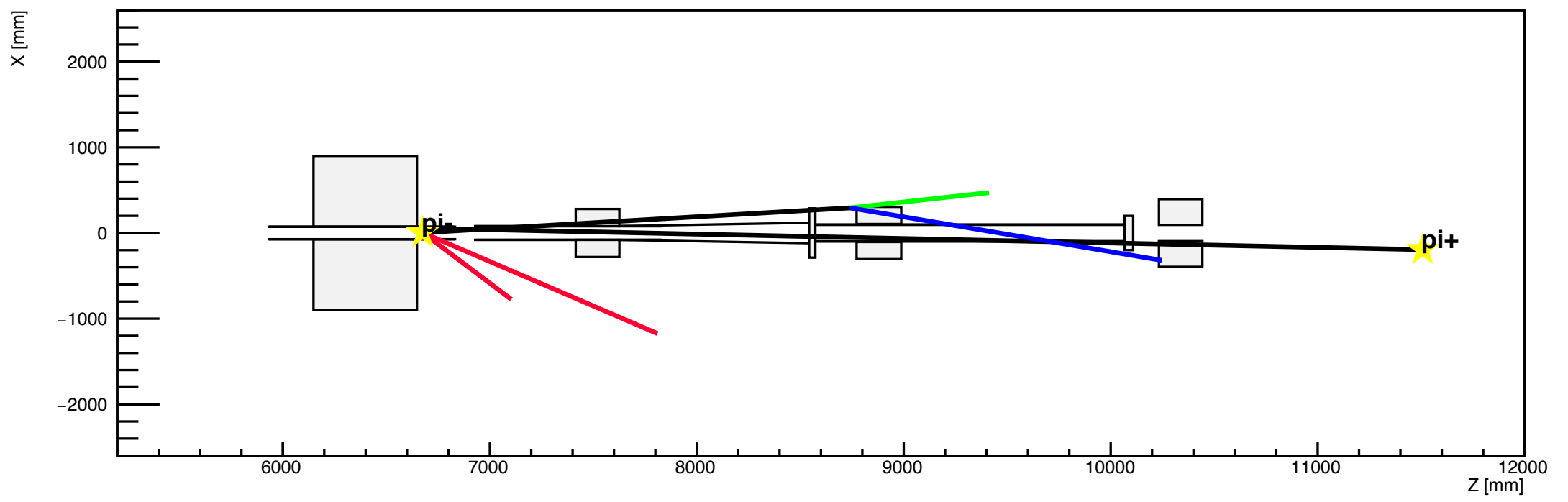

h1

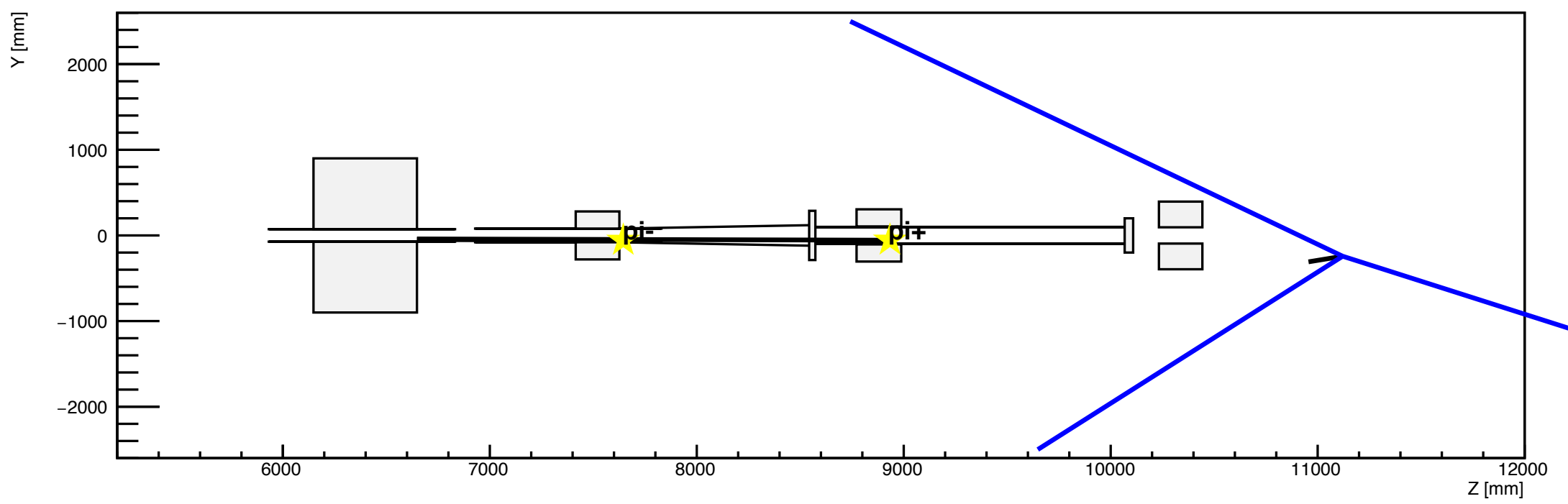

h2

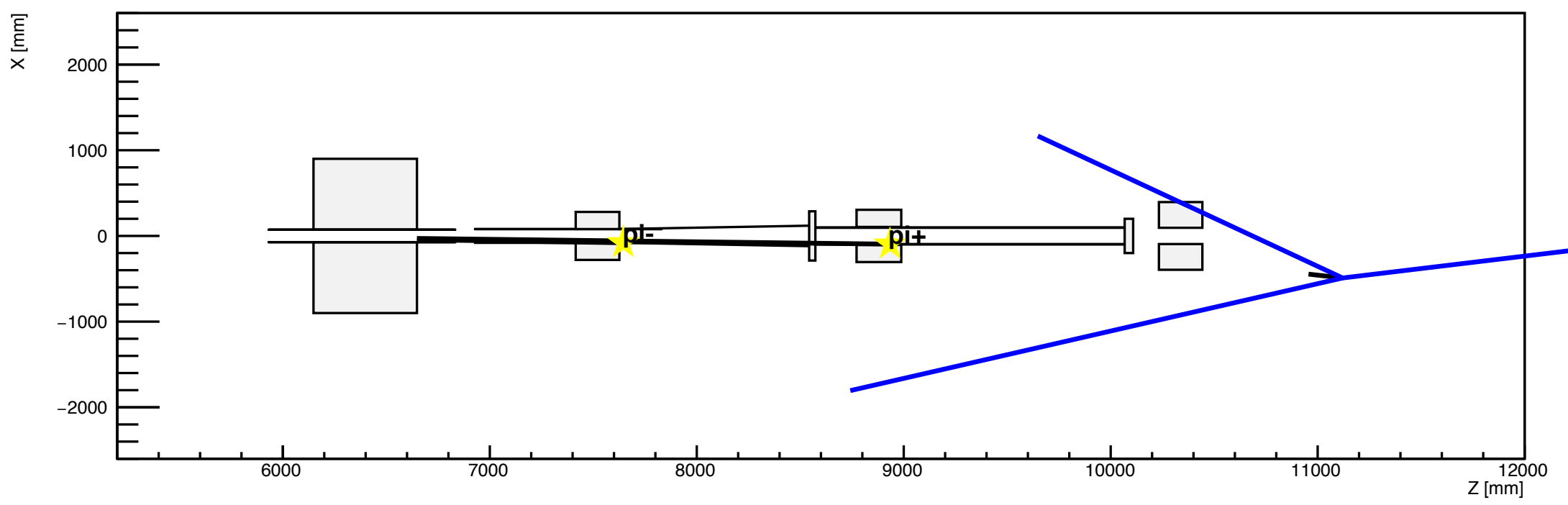

h1

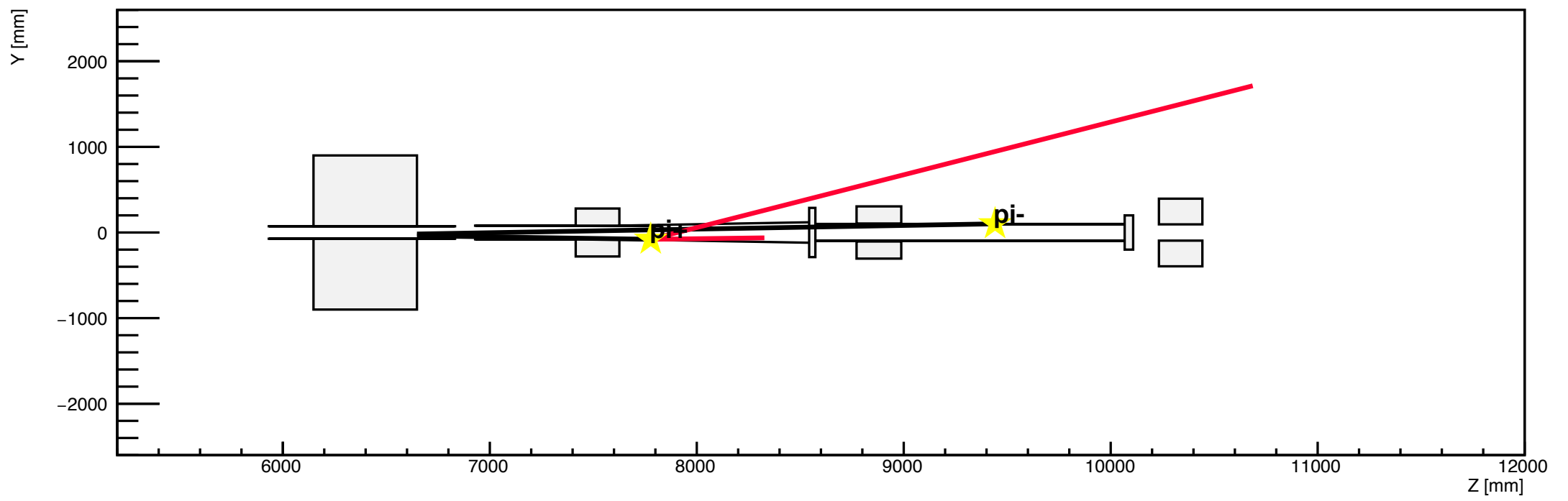

h2

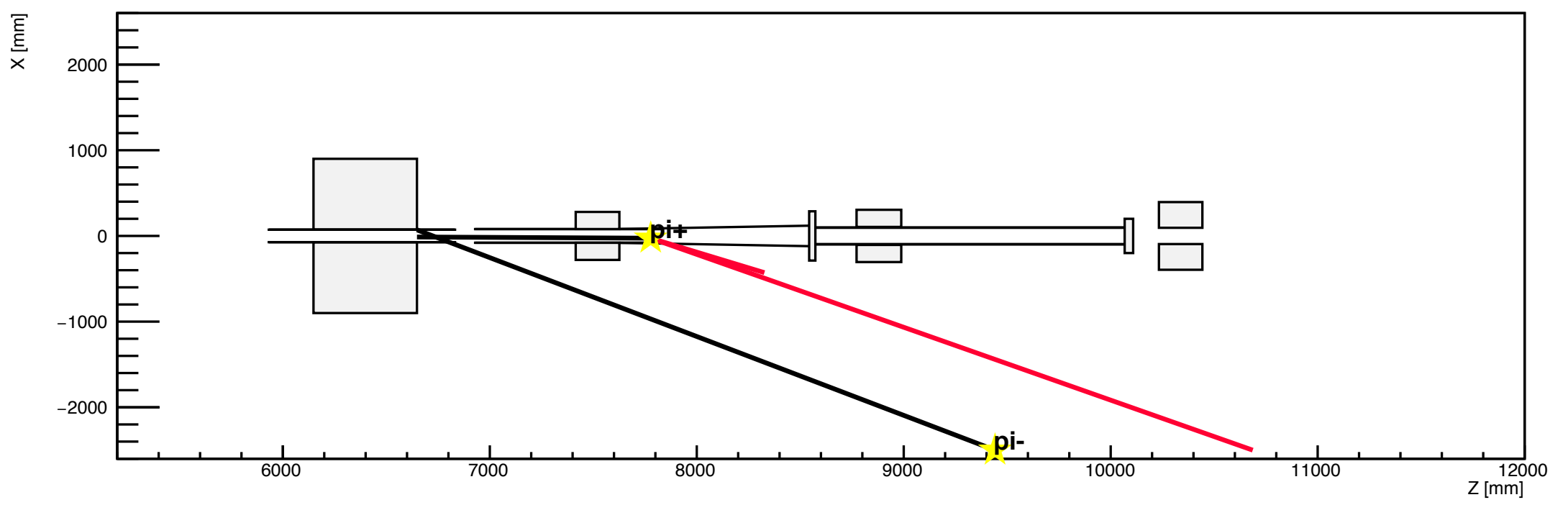

h1

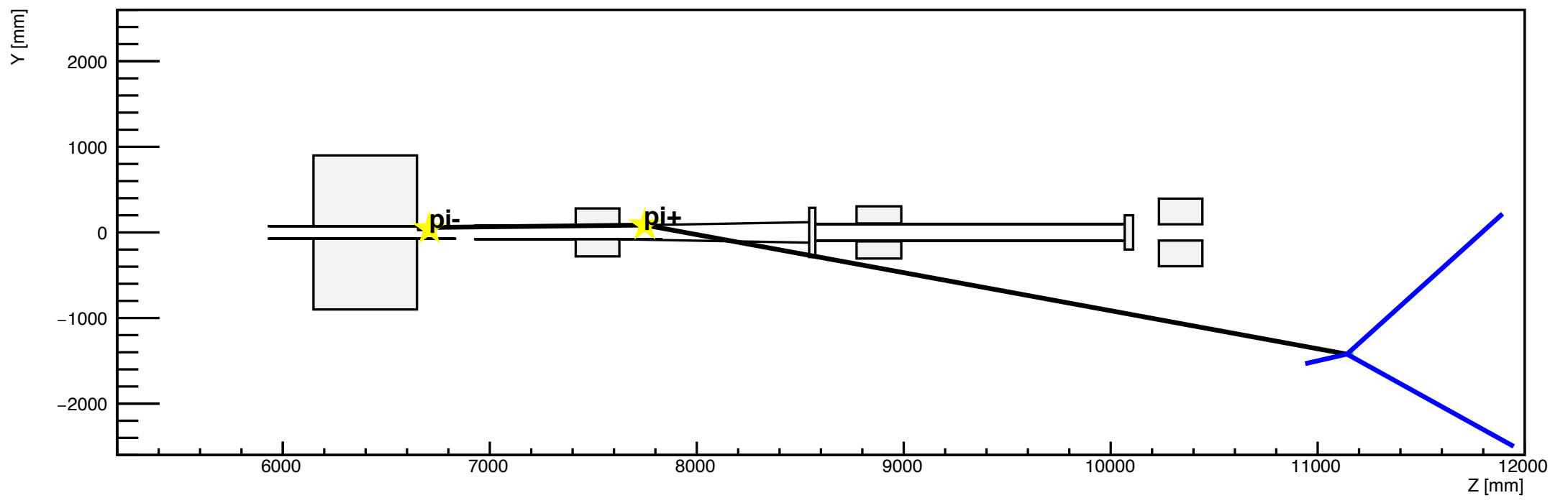

h2

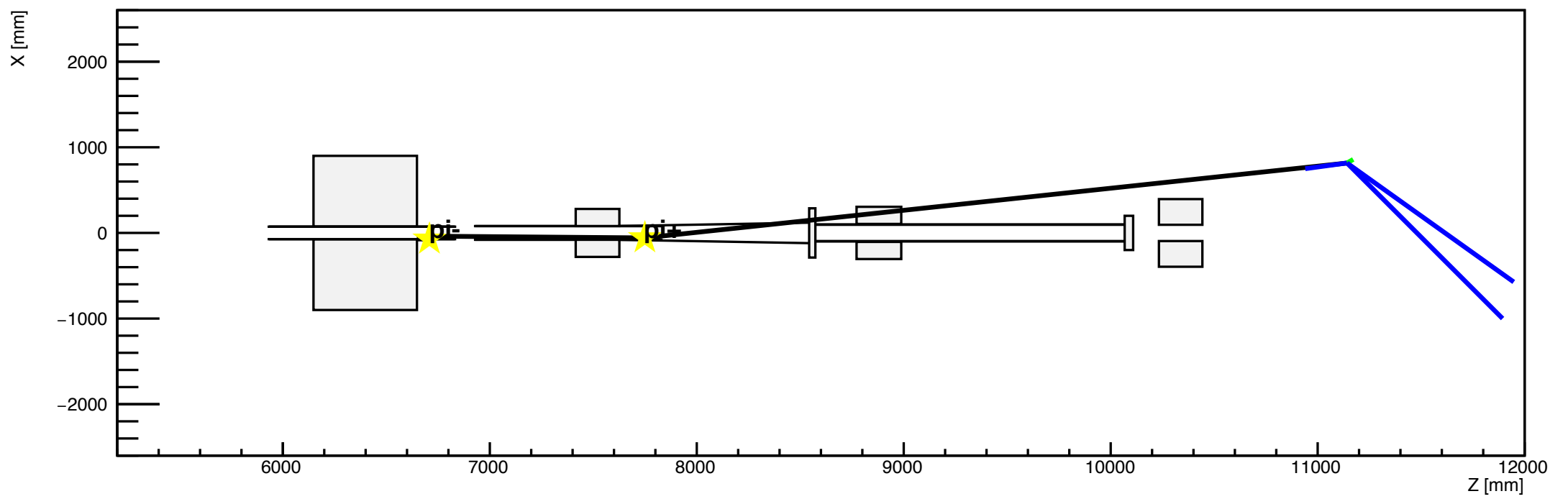

h1

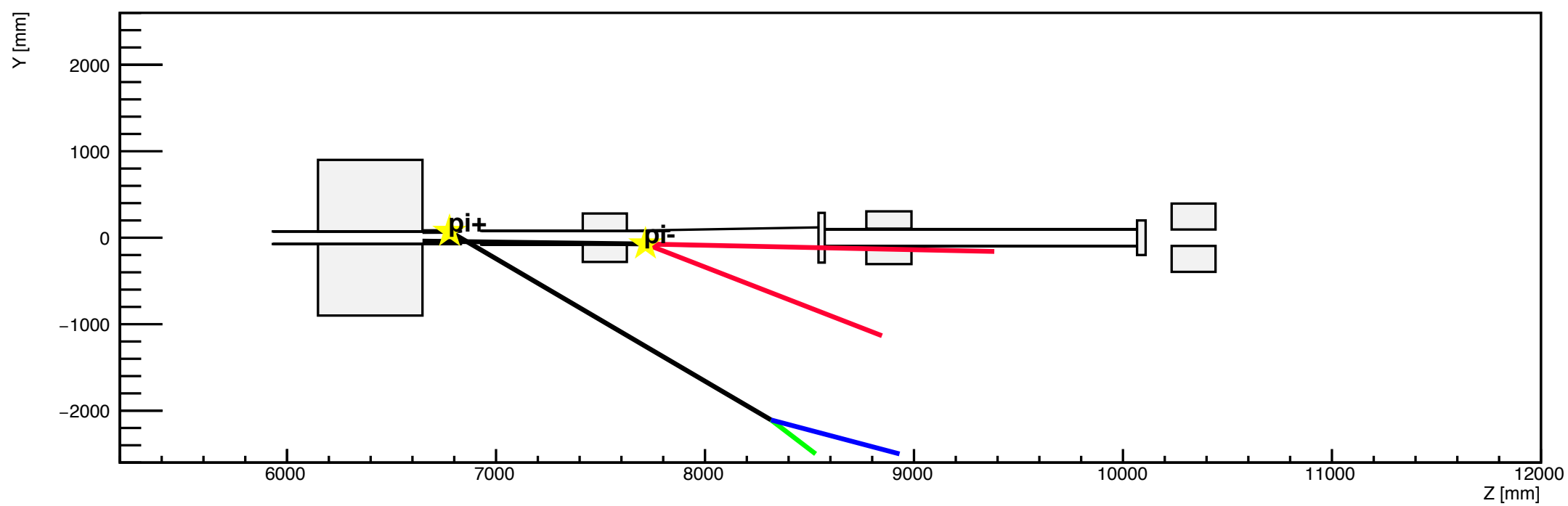

h2

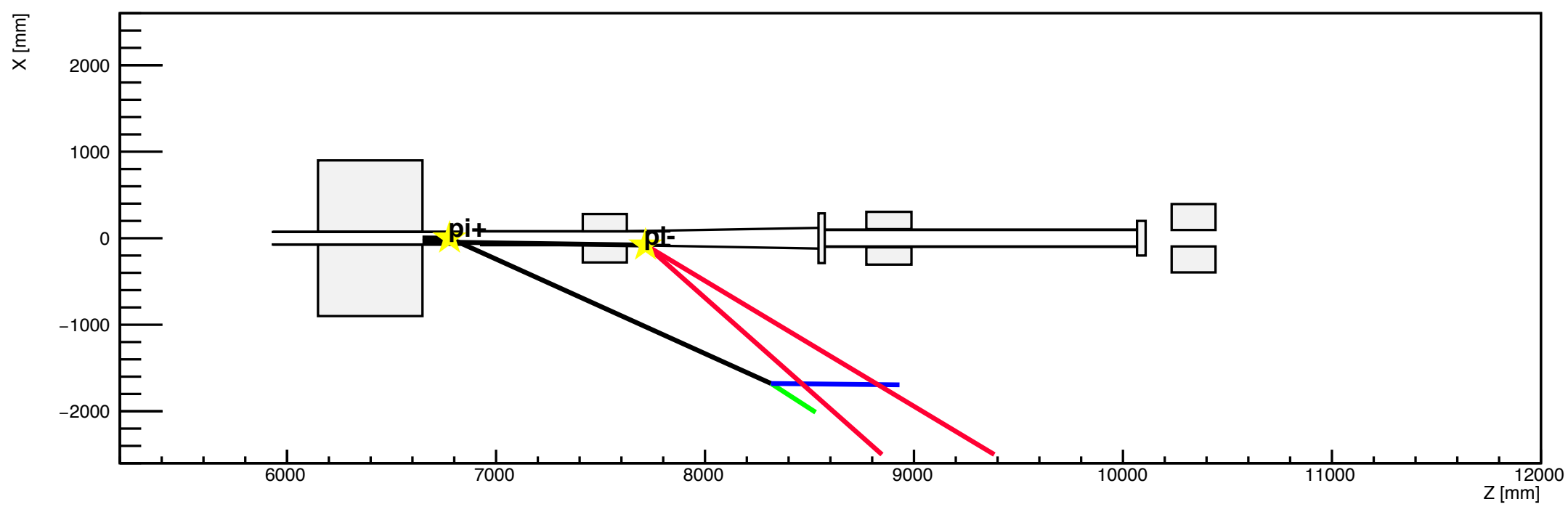

h1

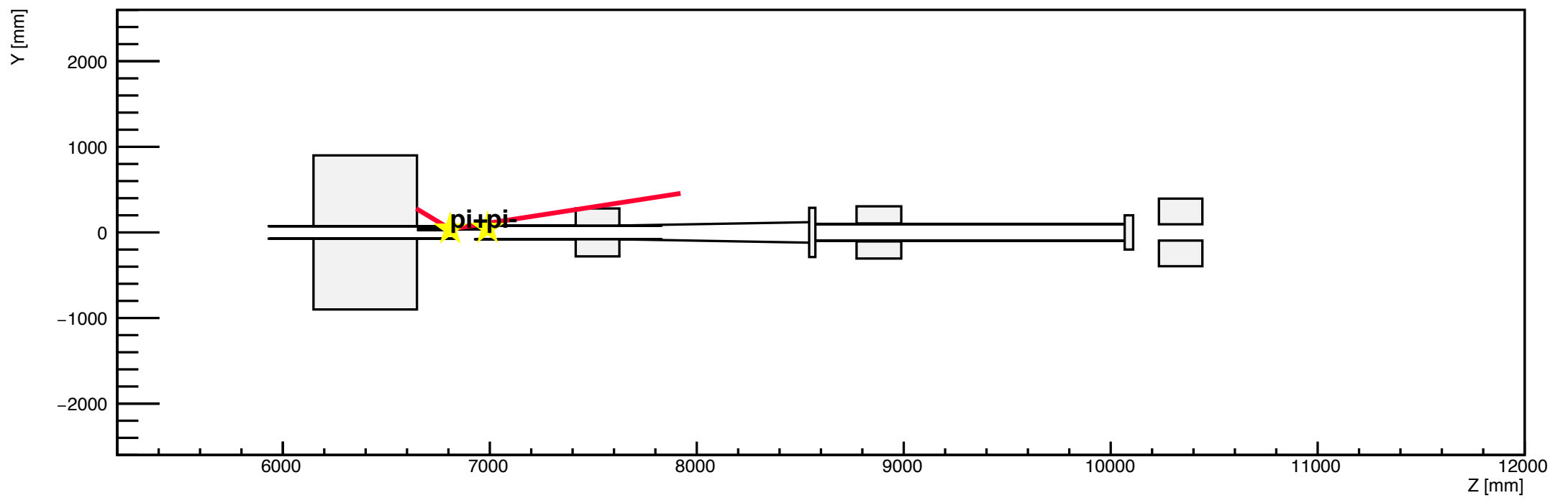

h2

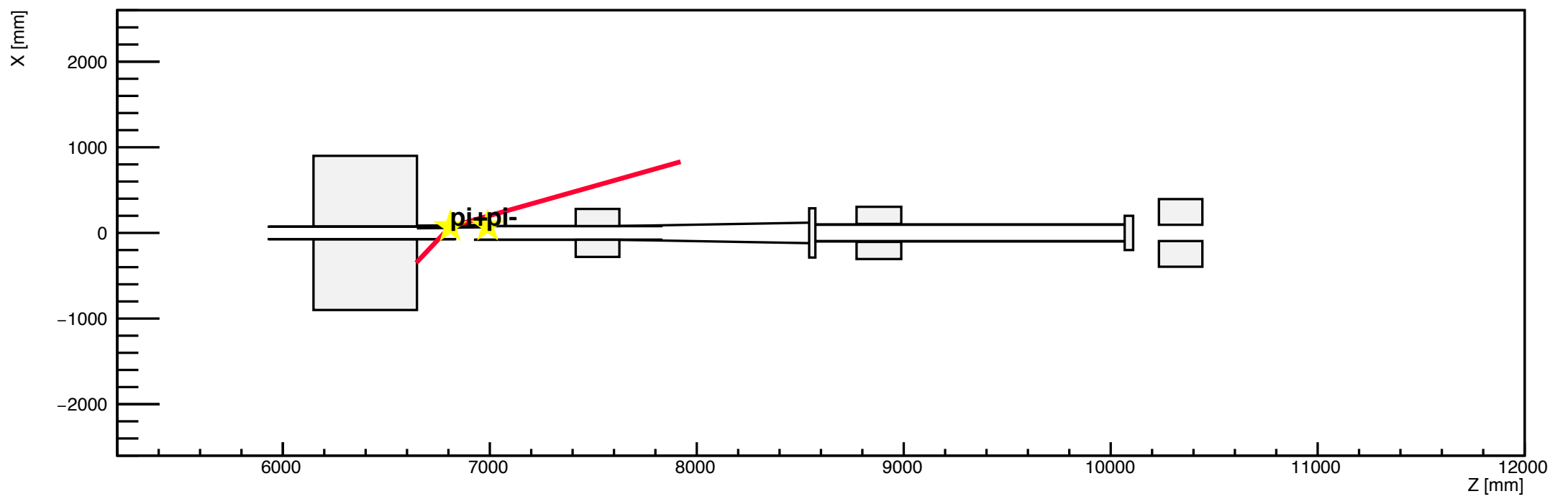

h1

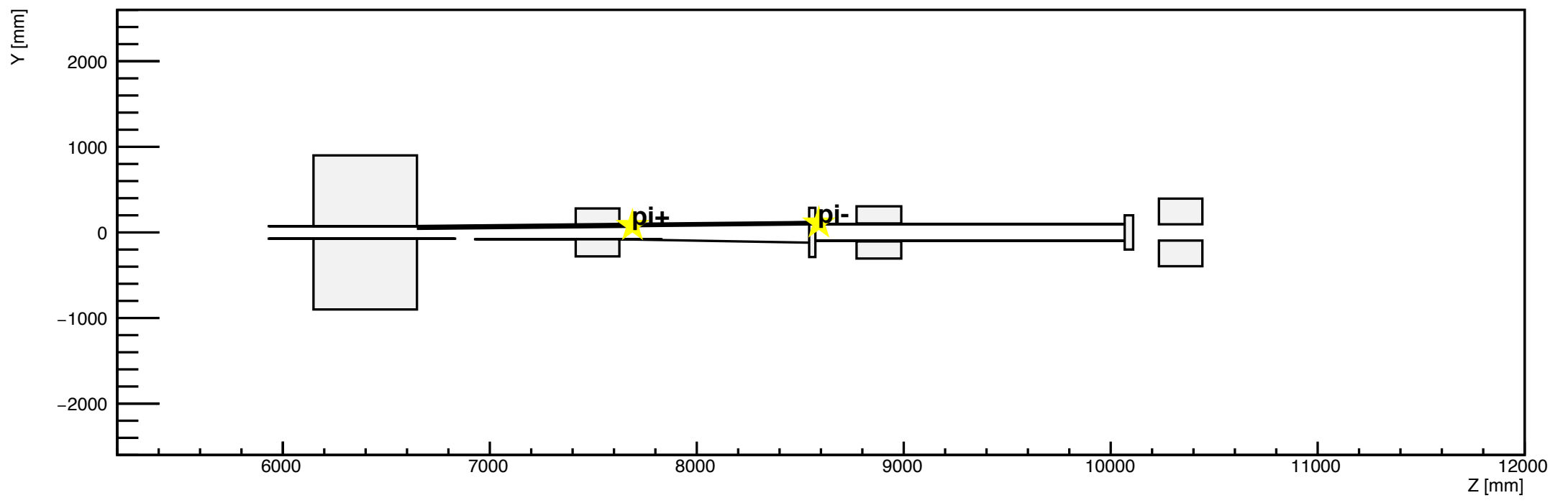

h2

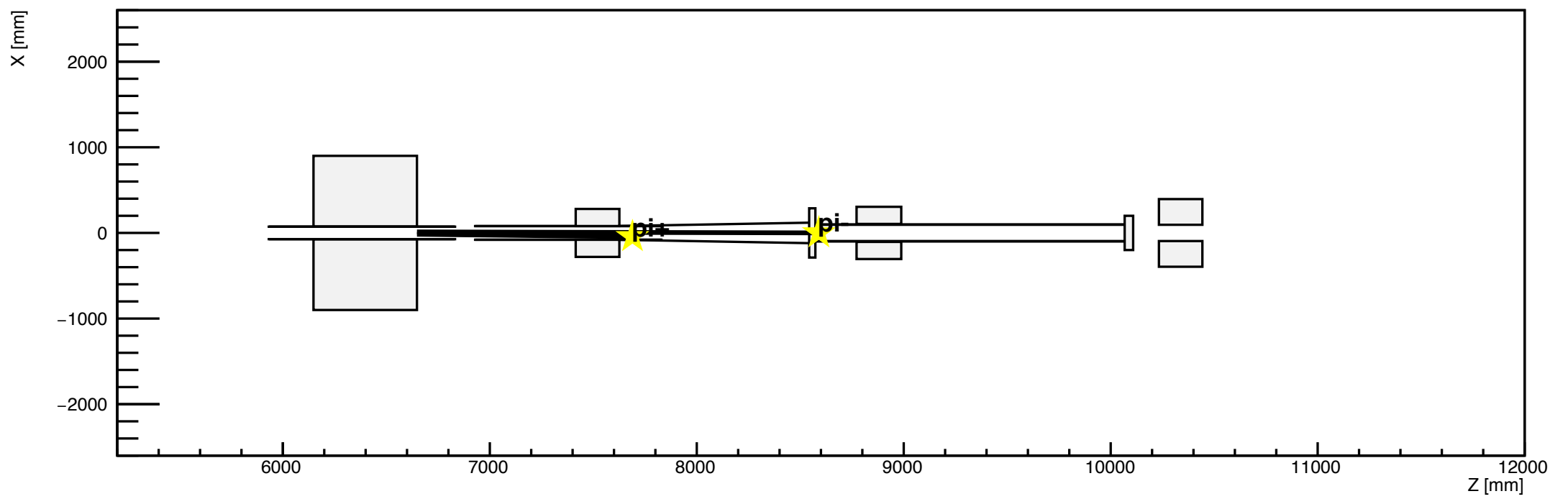

h1

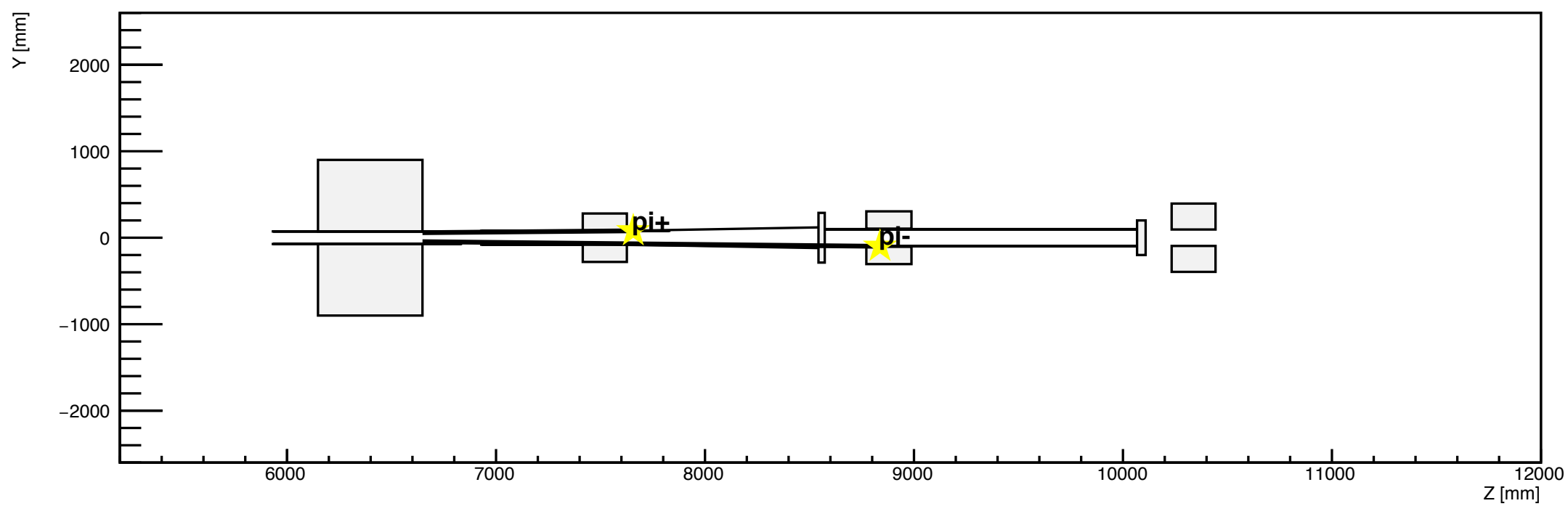

h2

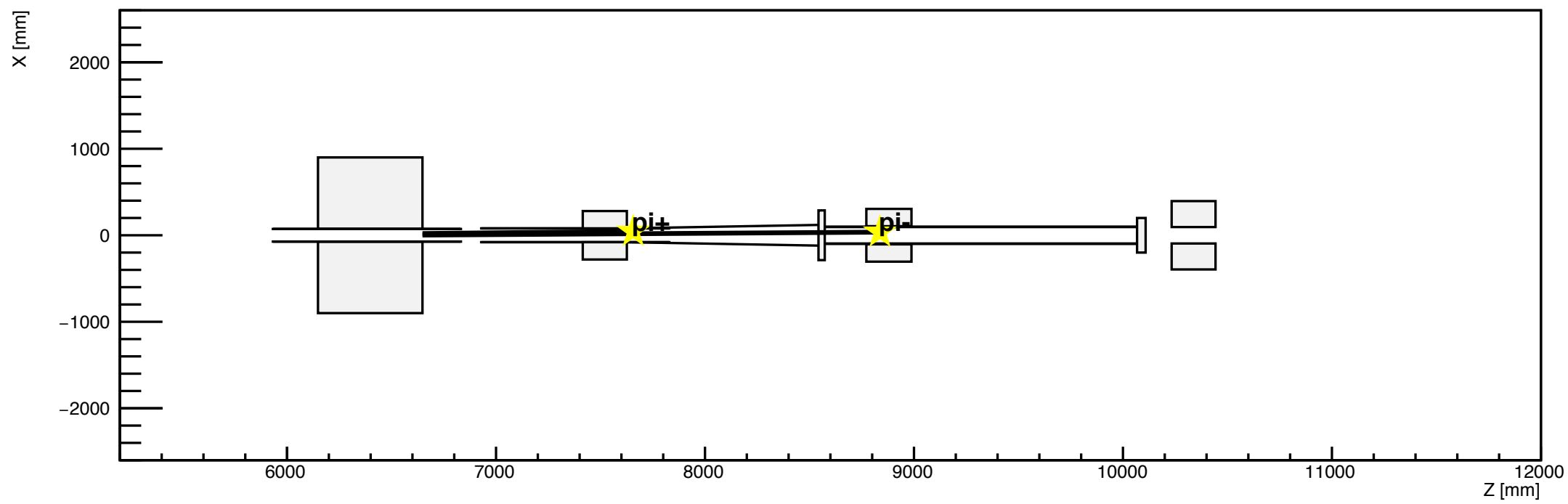

h1

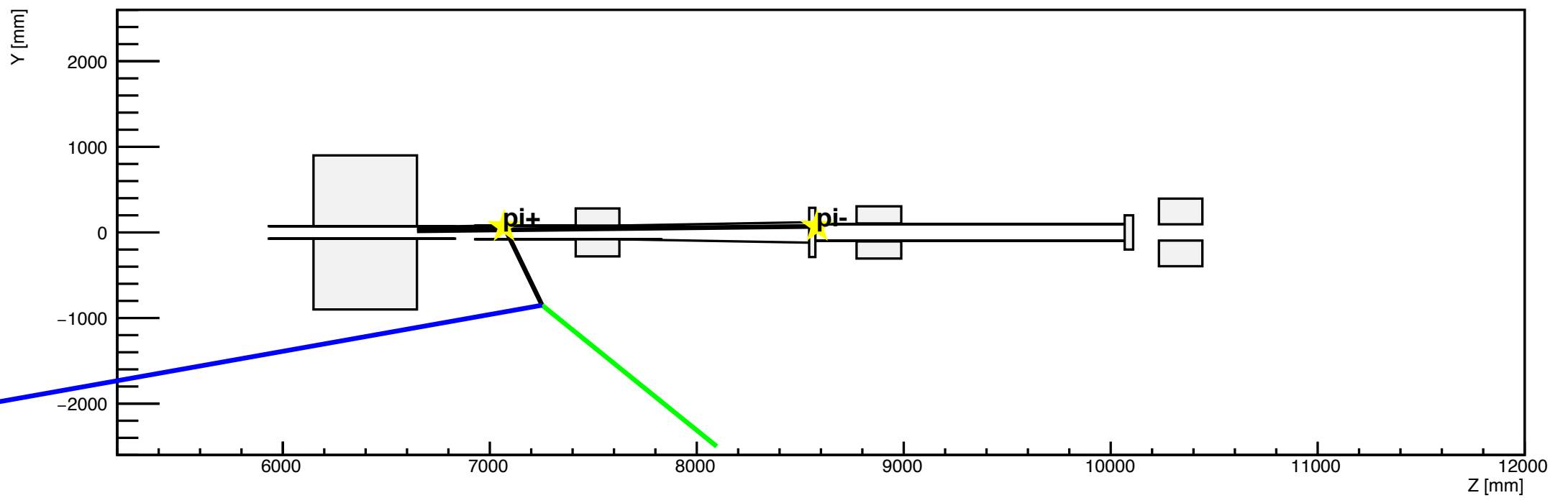

h2

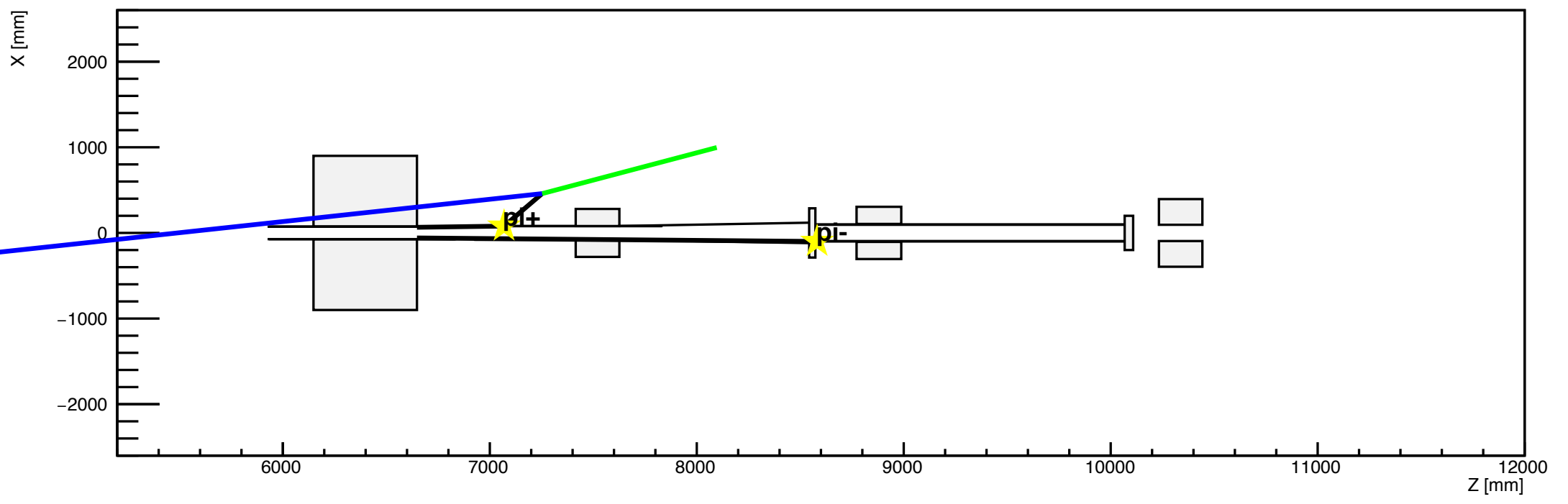

h1

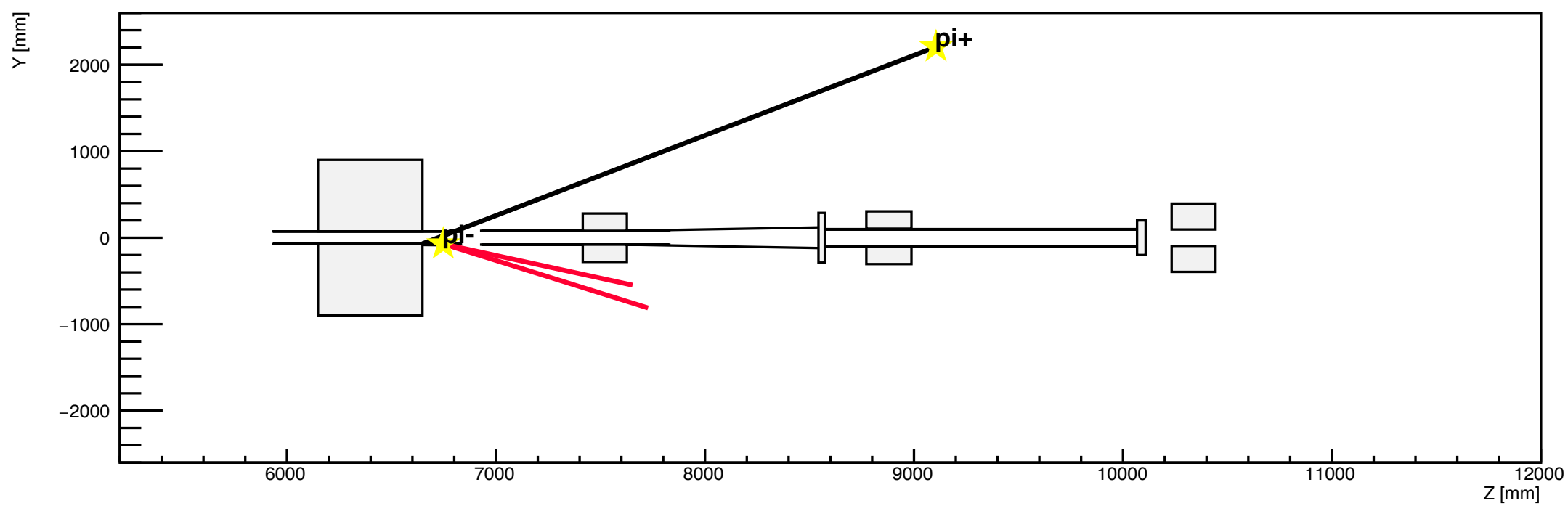

h2

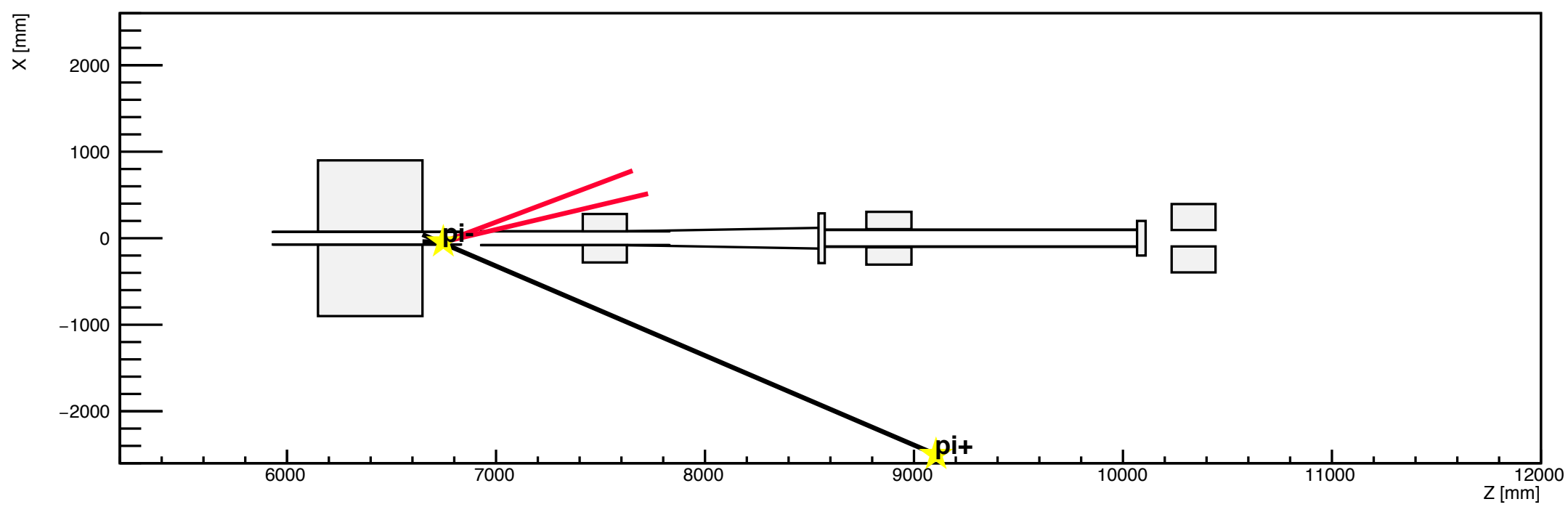

h1

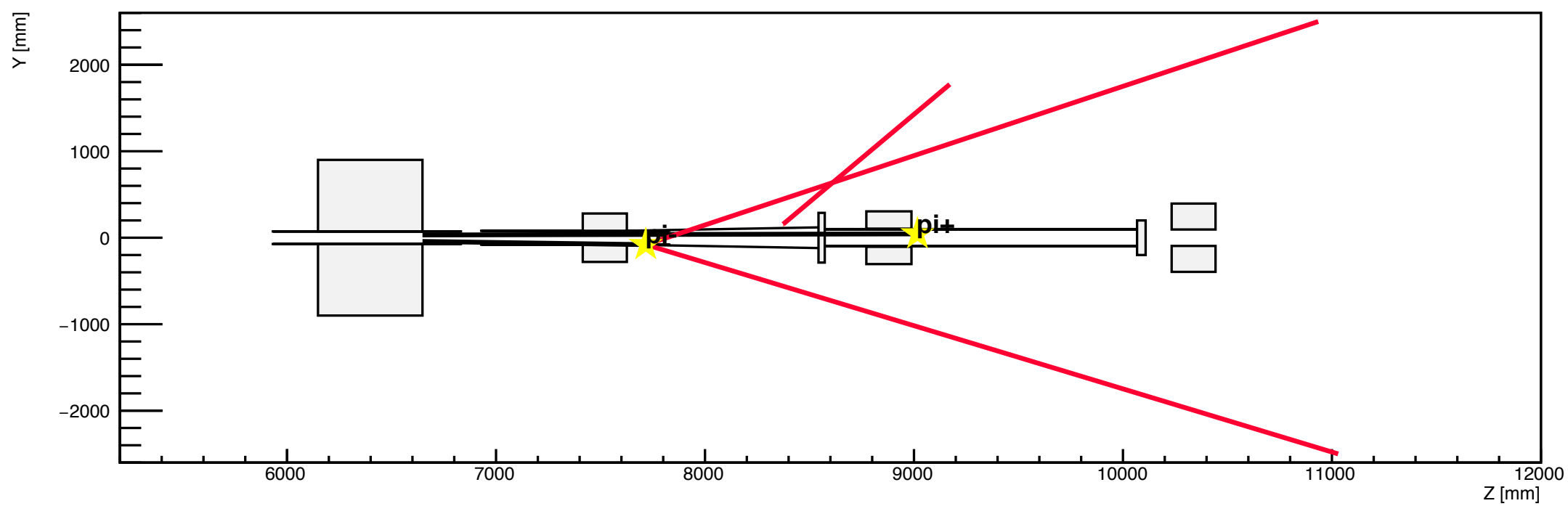

h2

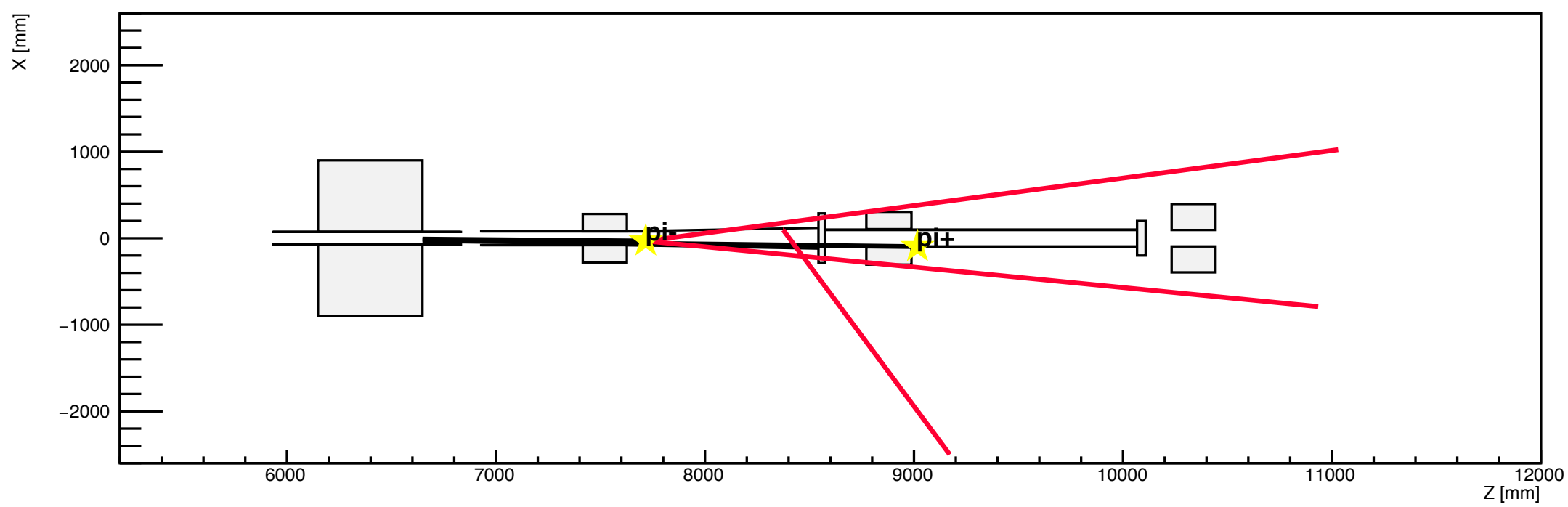

h1

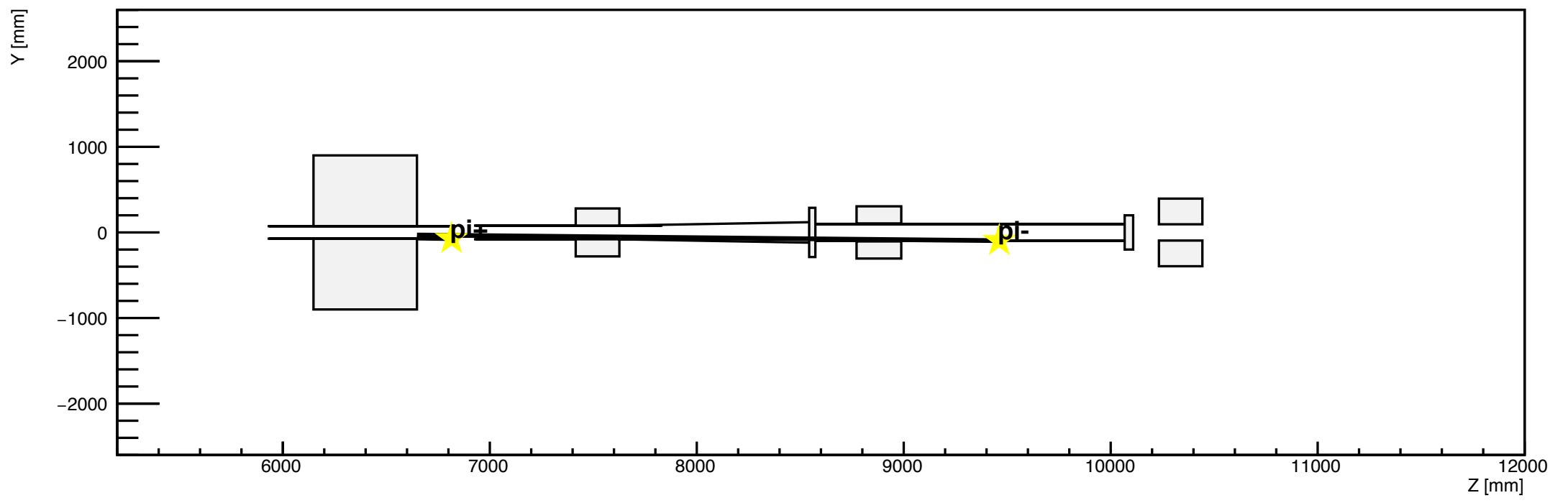

h2

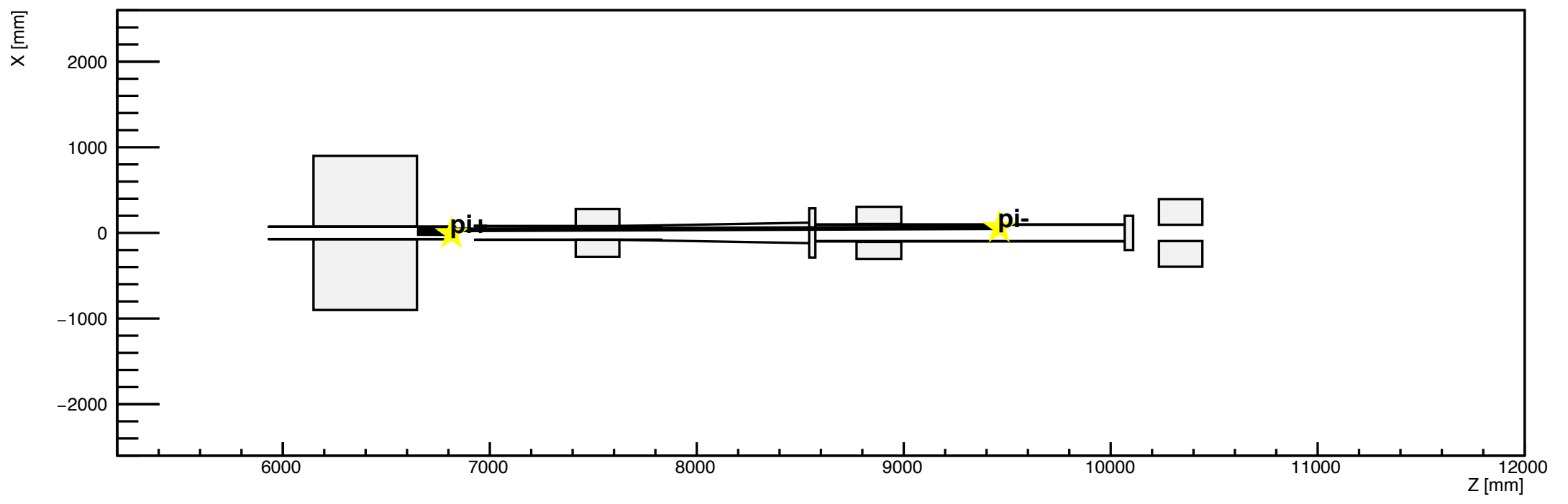

h1

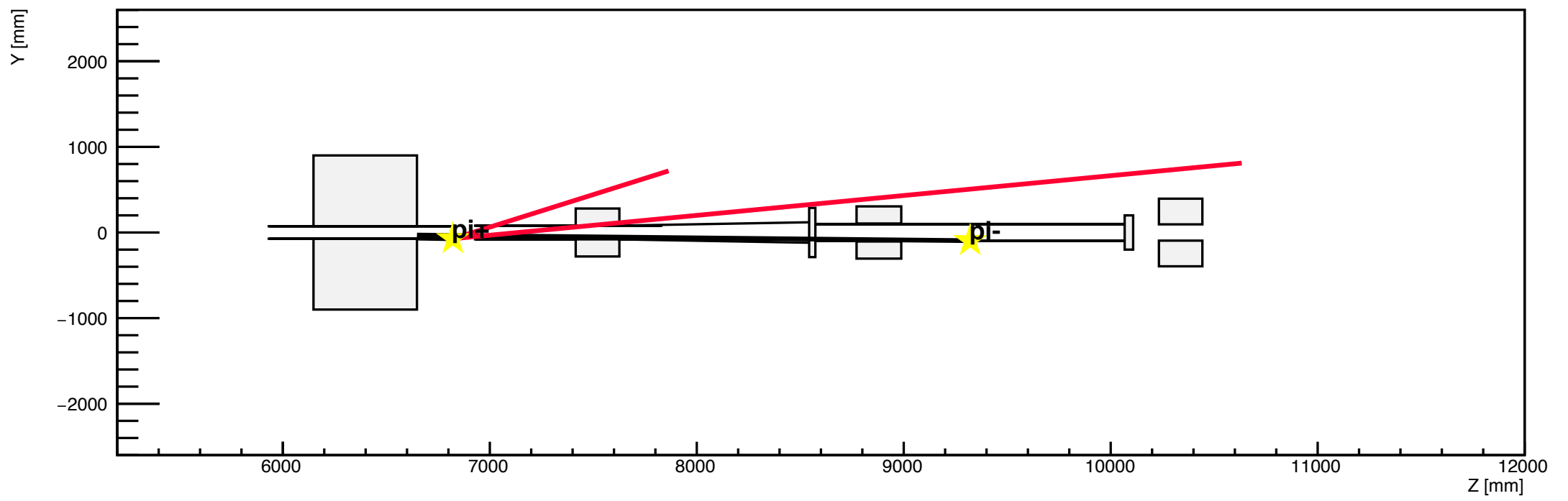

h2

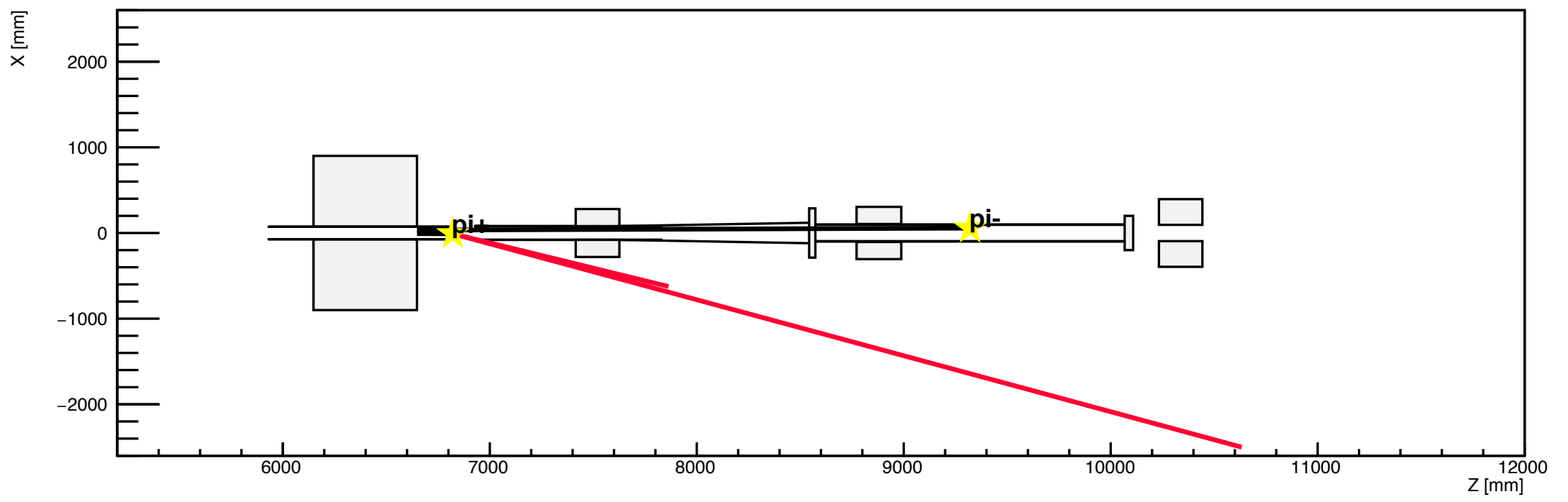

h1

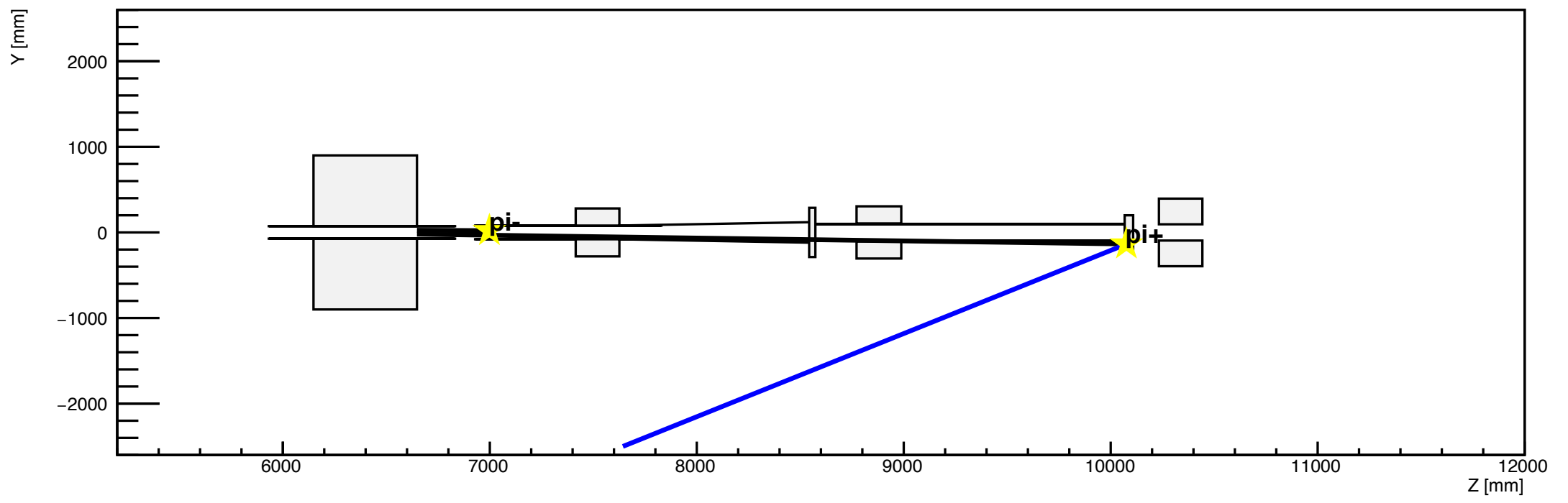

h2

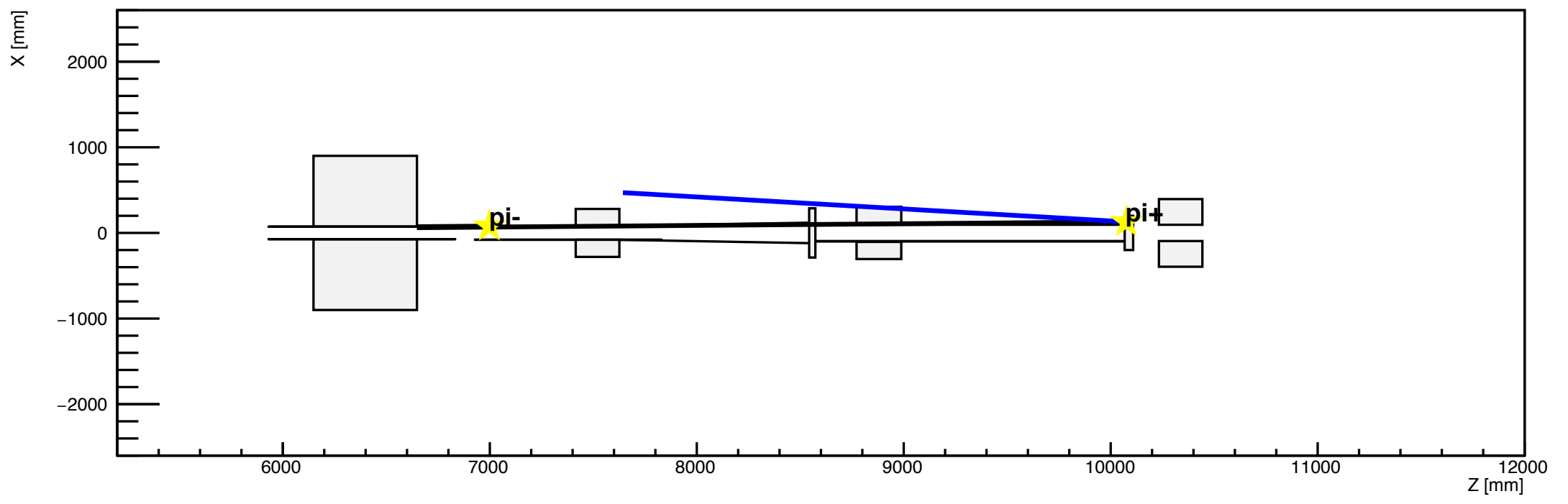

h1

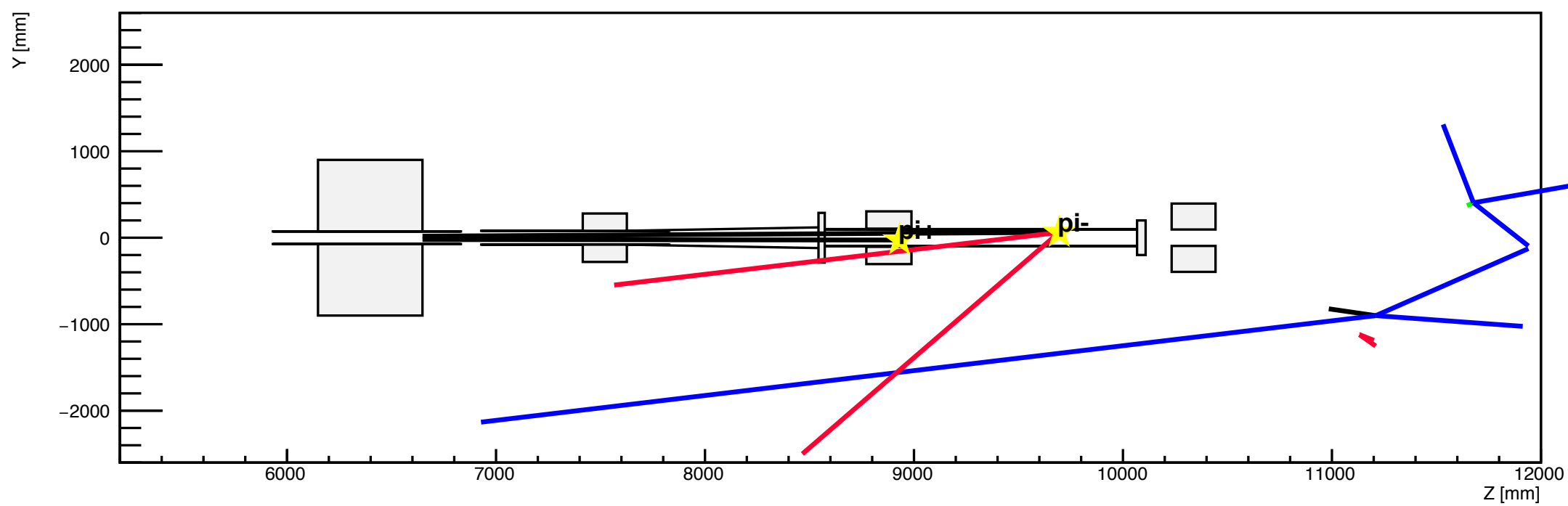

h2

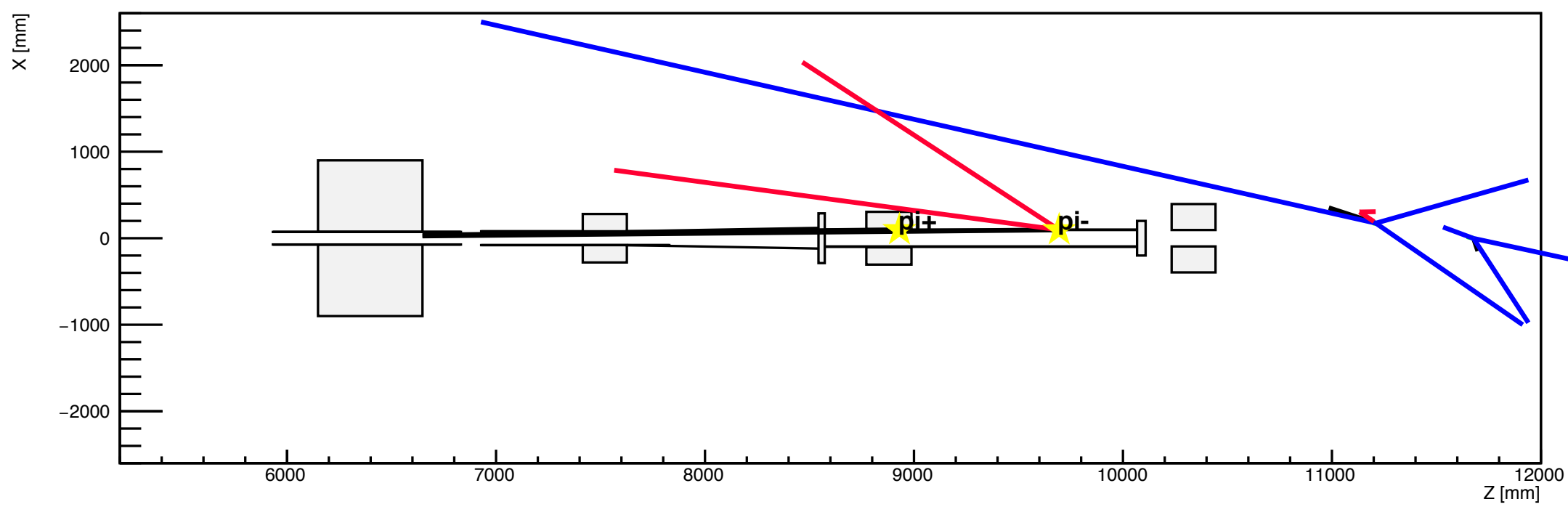

h1

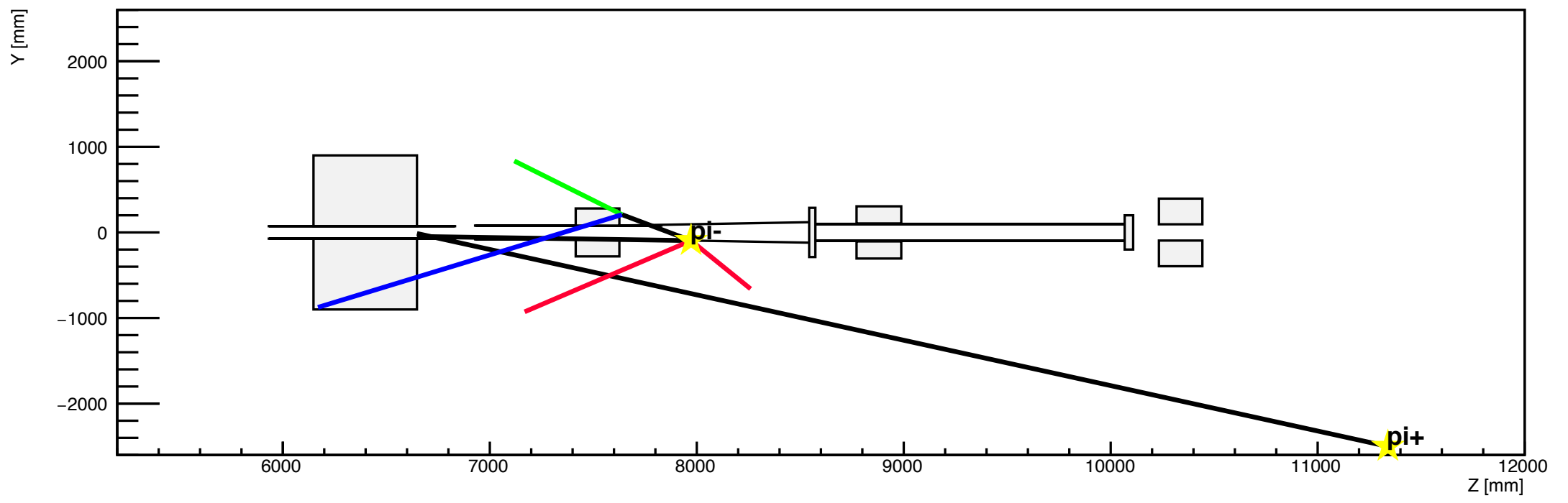

h2

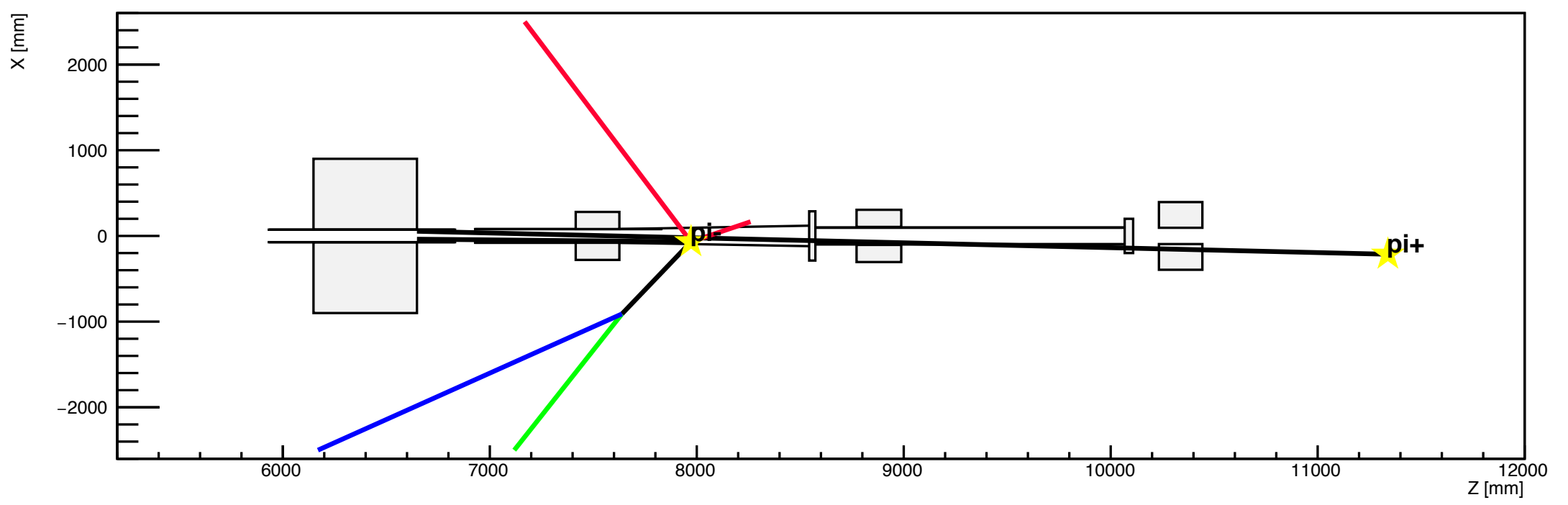

h1

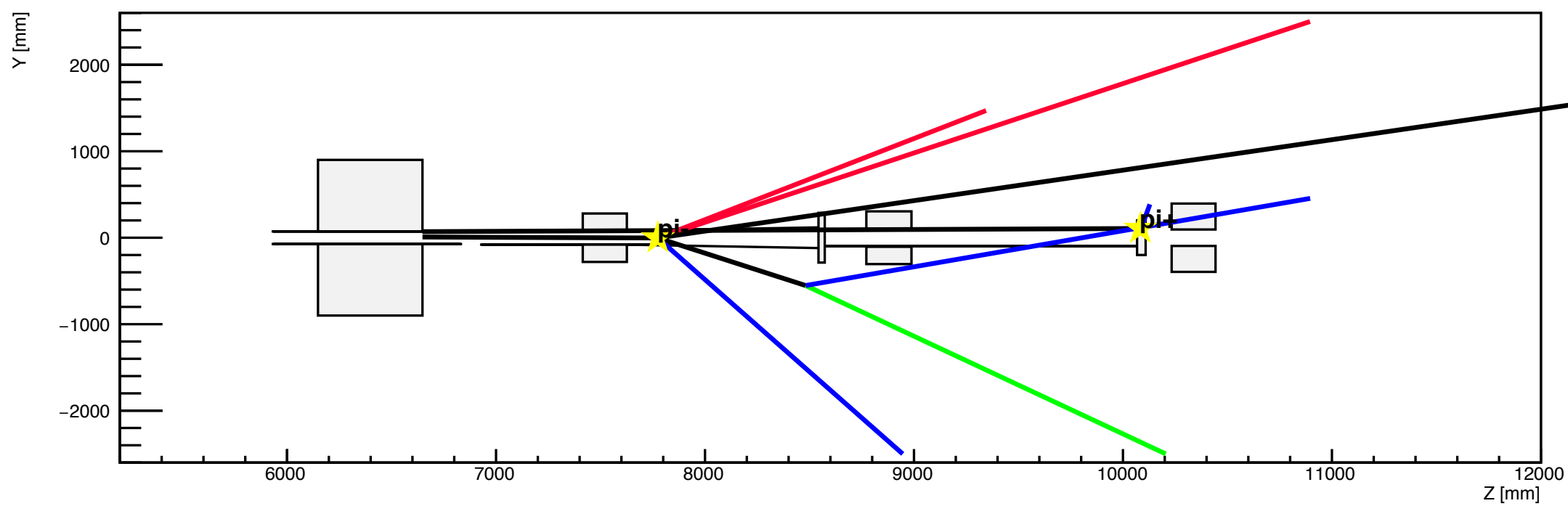

h2

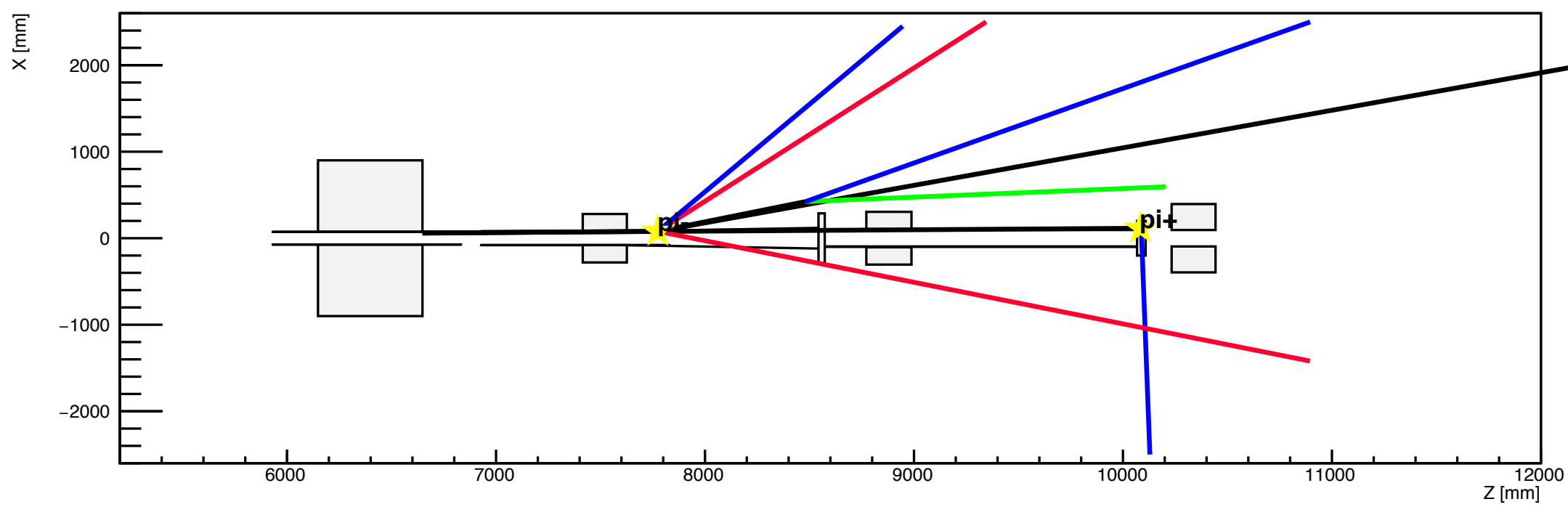

h1

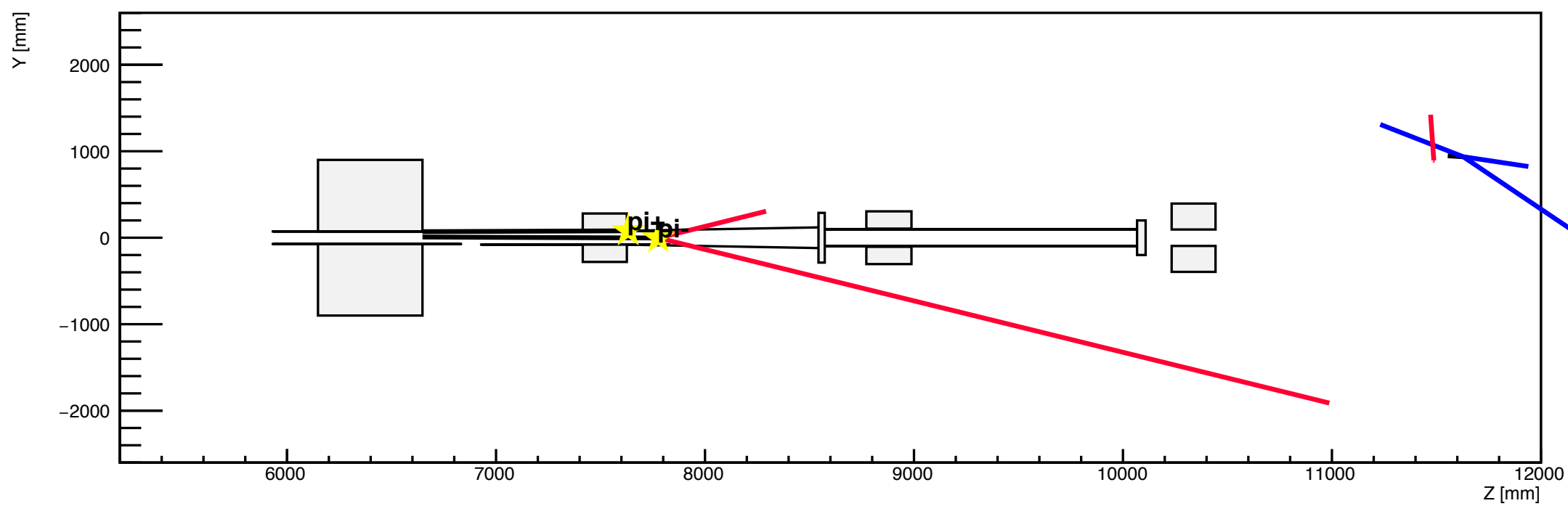

h2

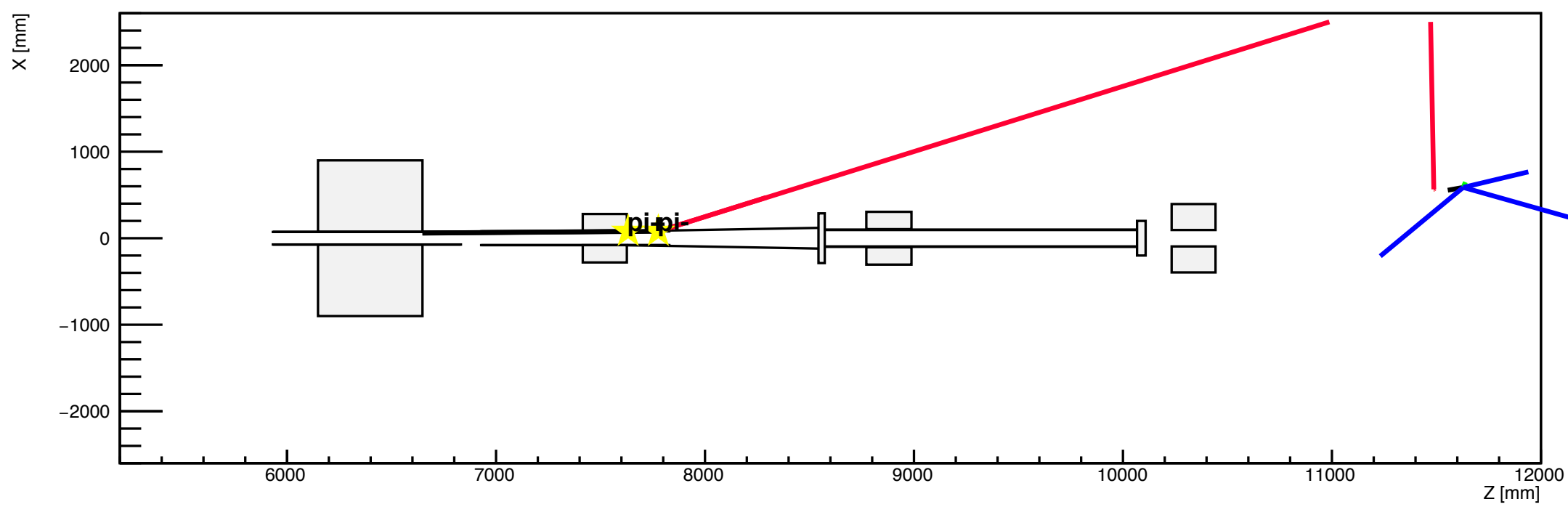

h1

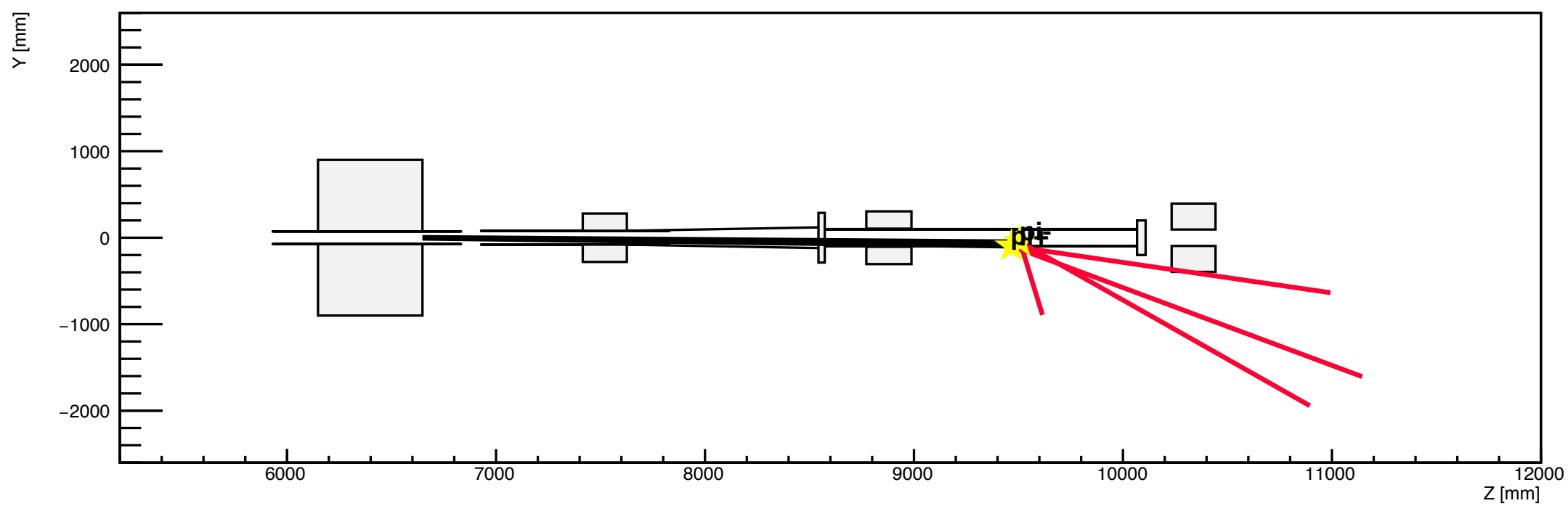

h2

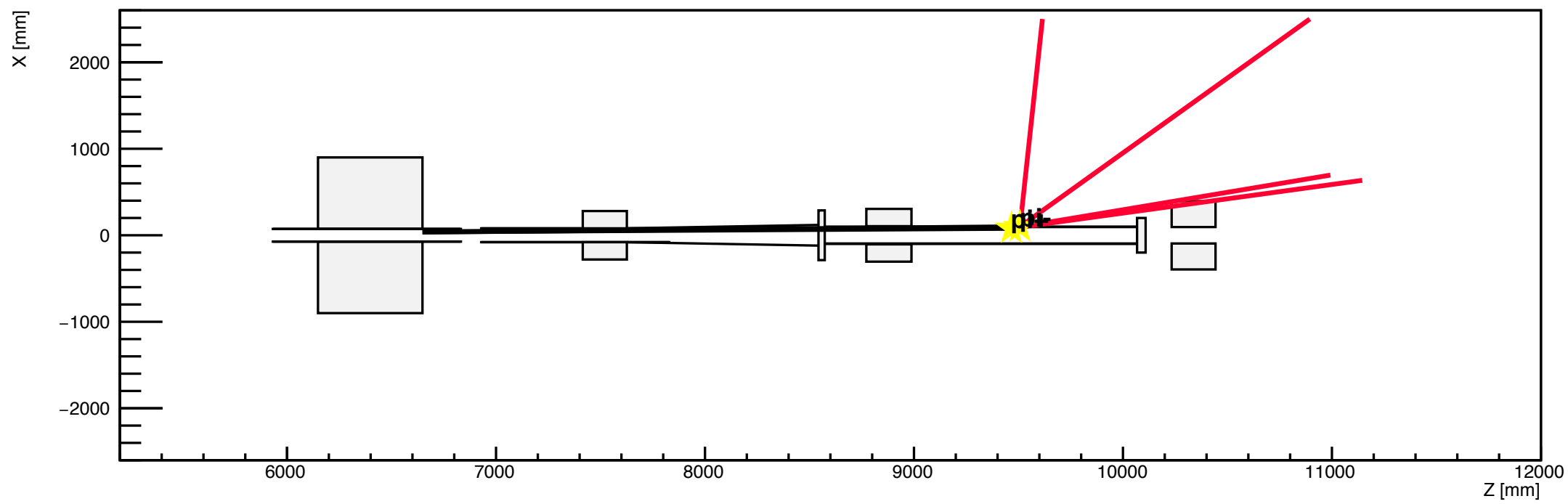

h1

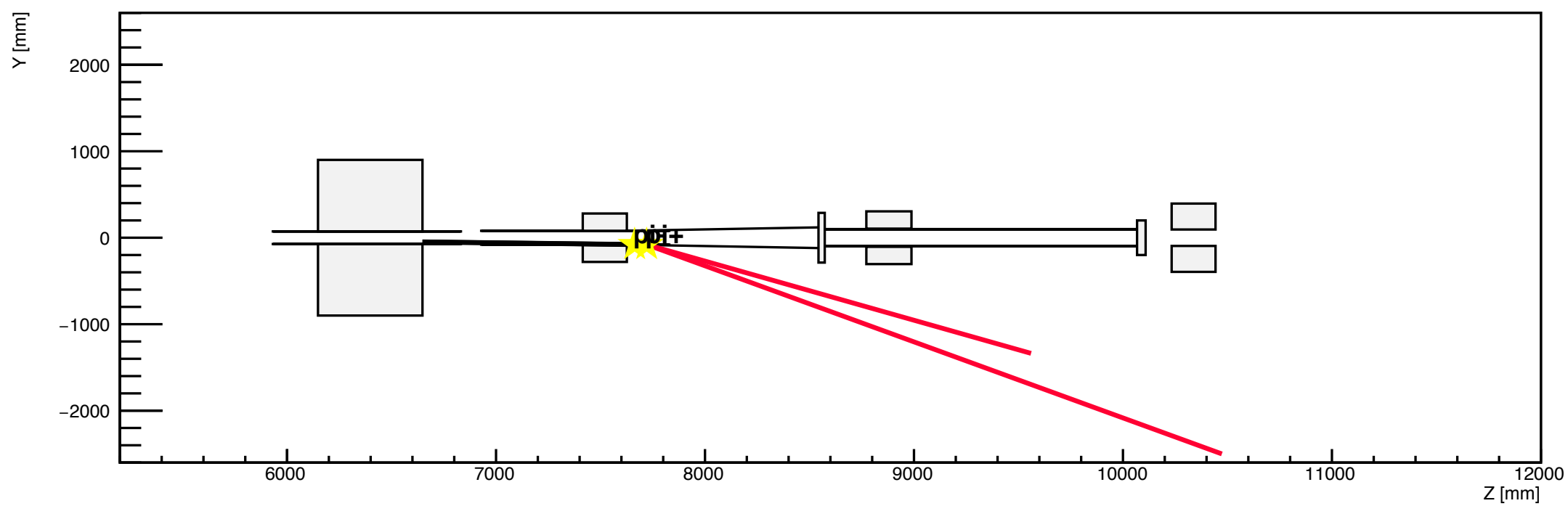

h2

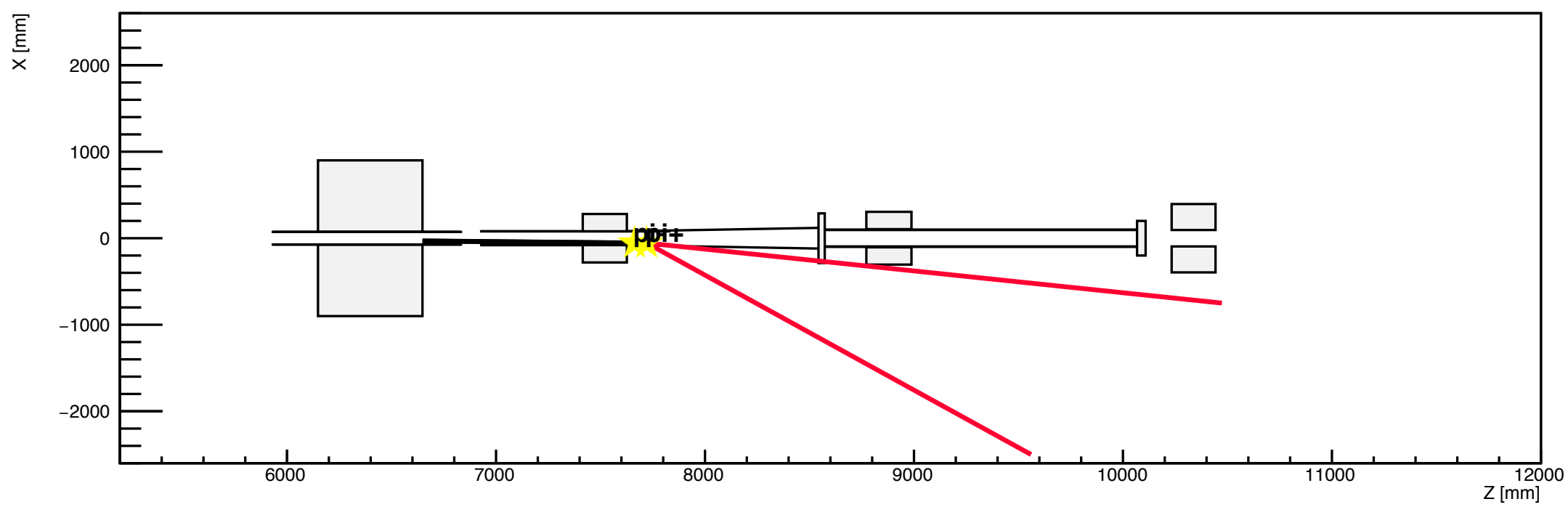

h1

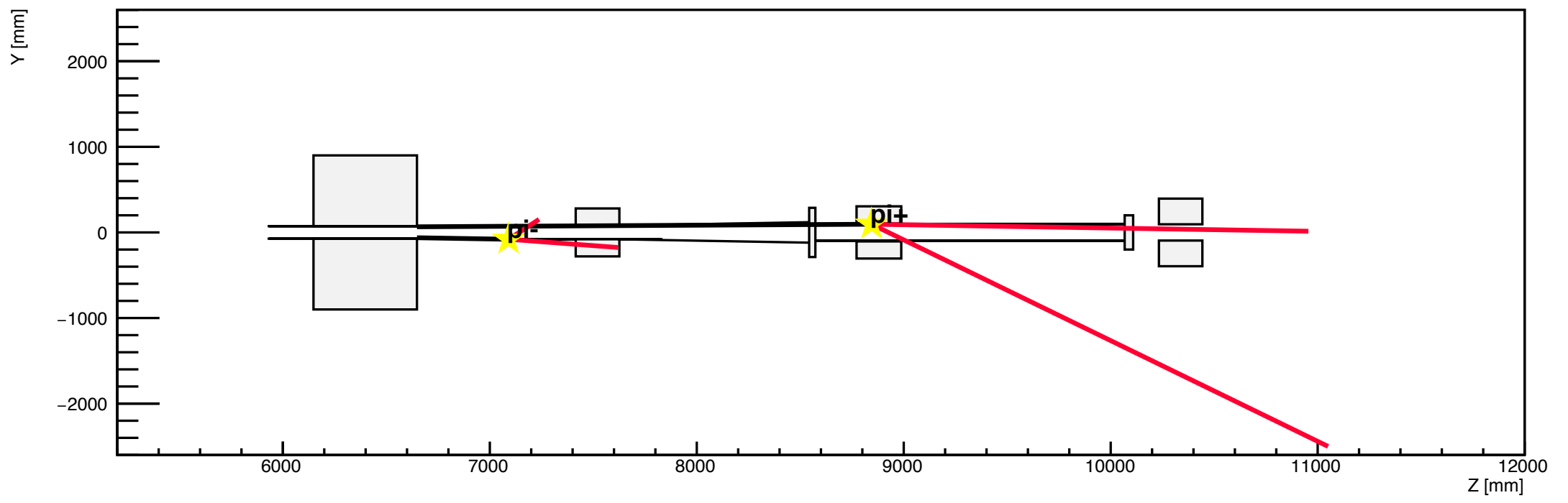

h2

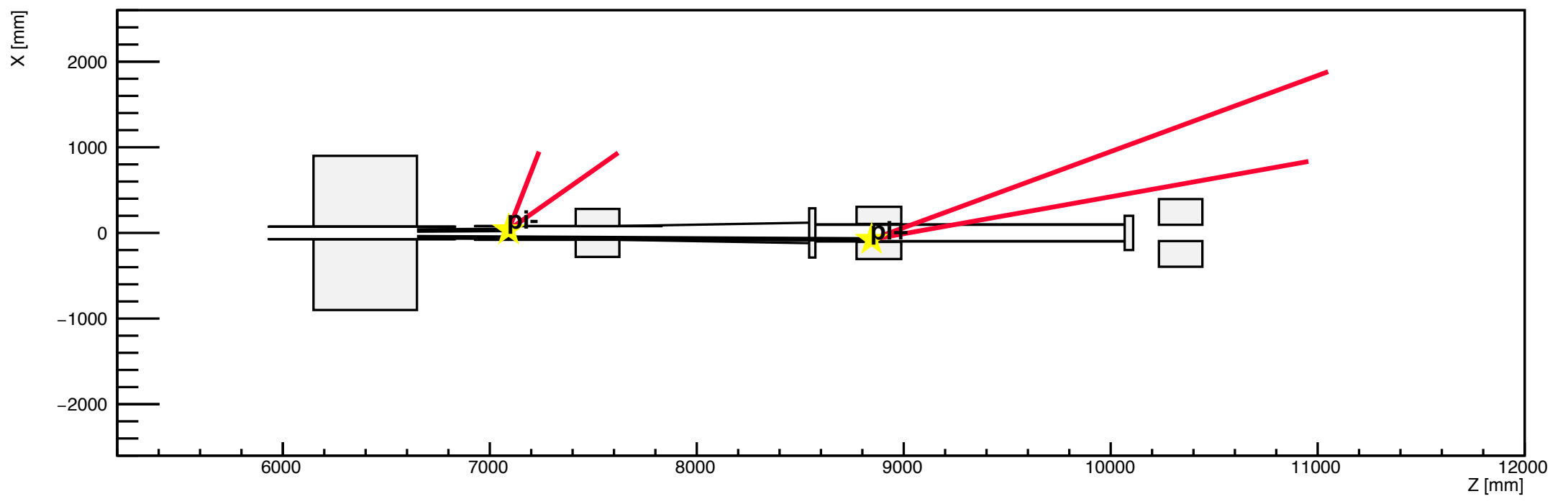

h1

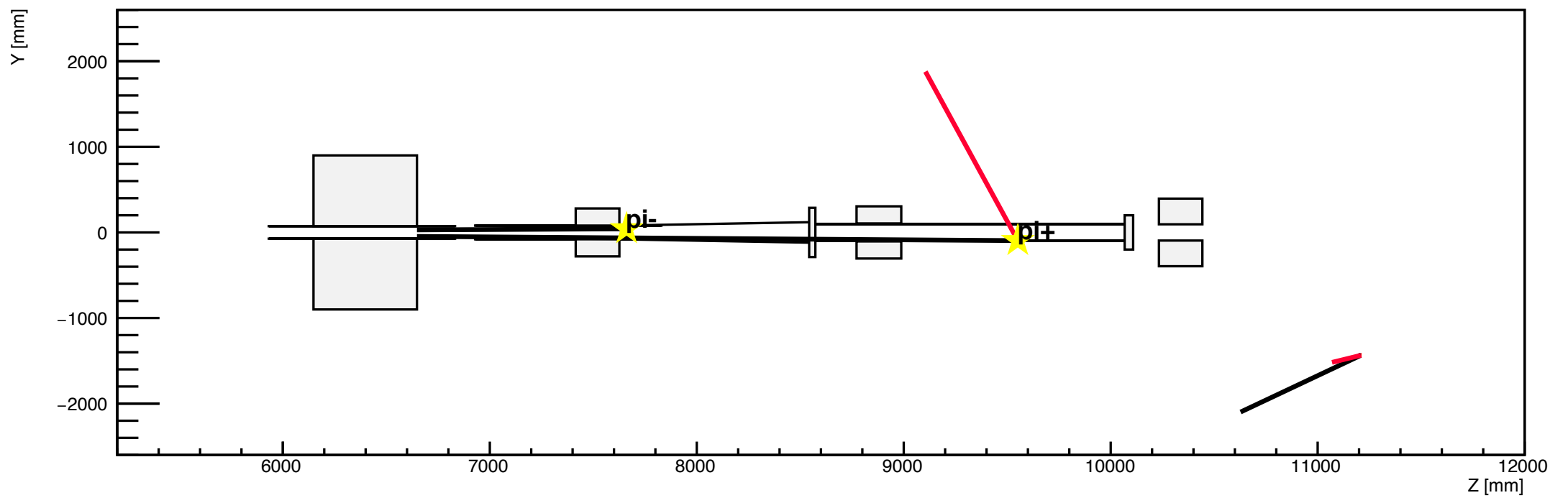

h2

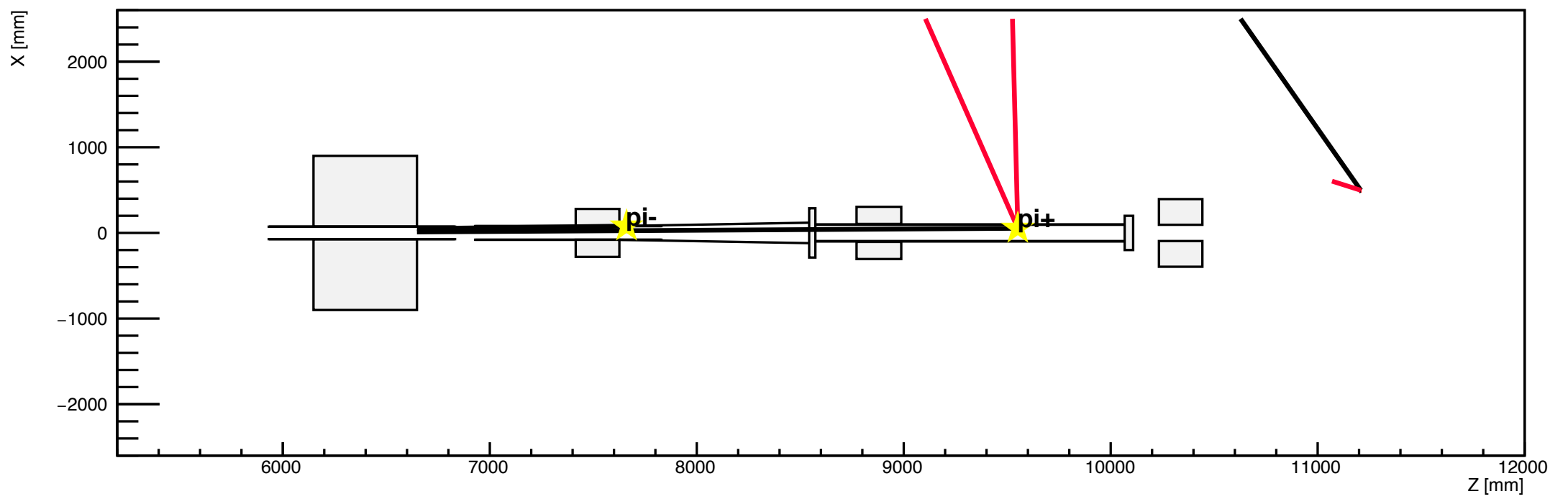

h1

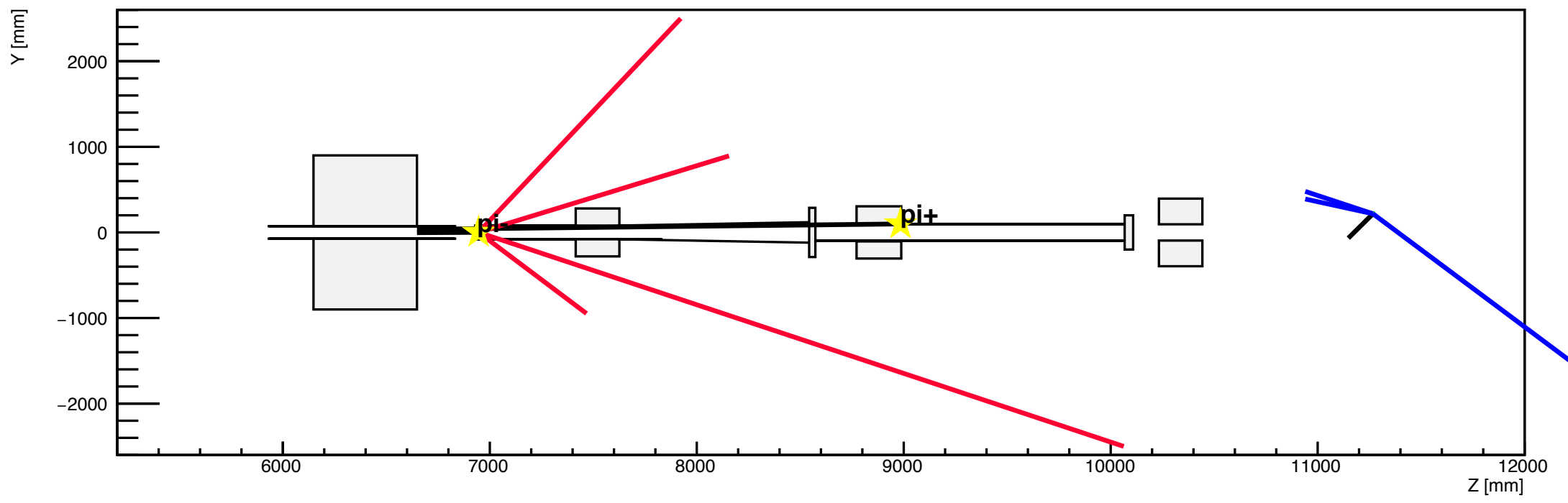

h2

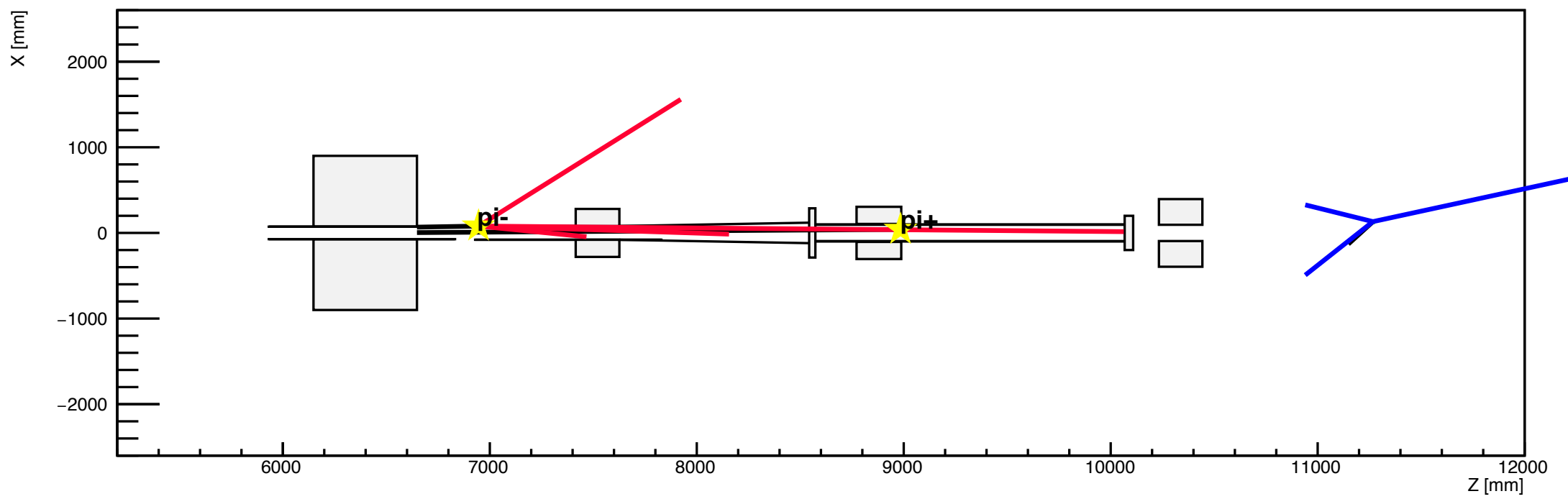

h1

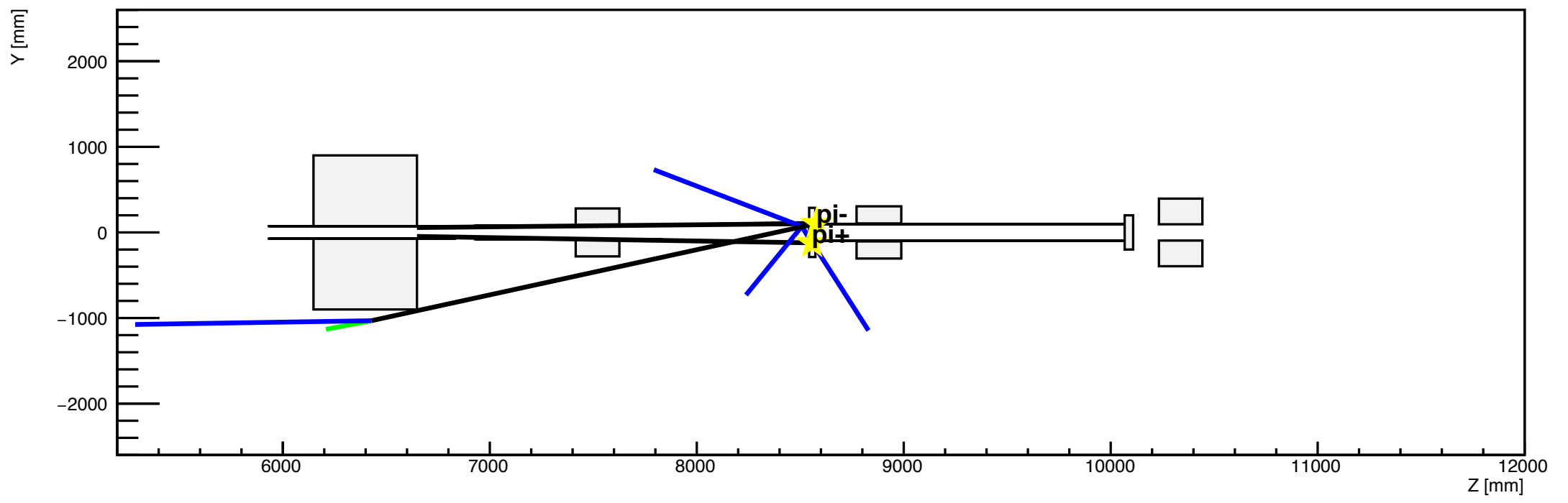

h2

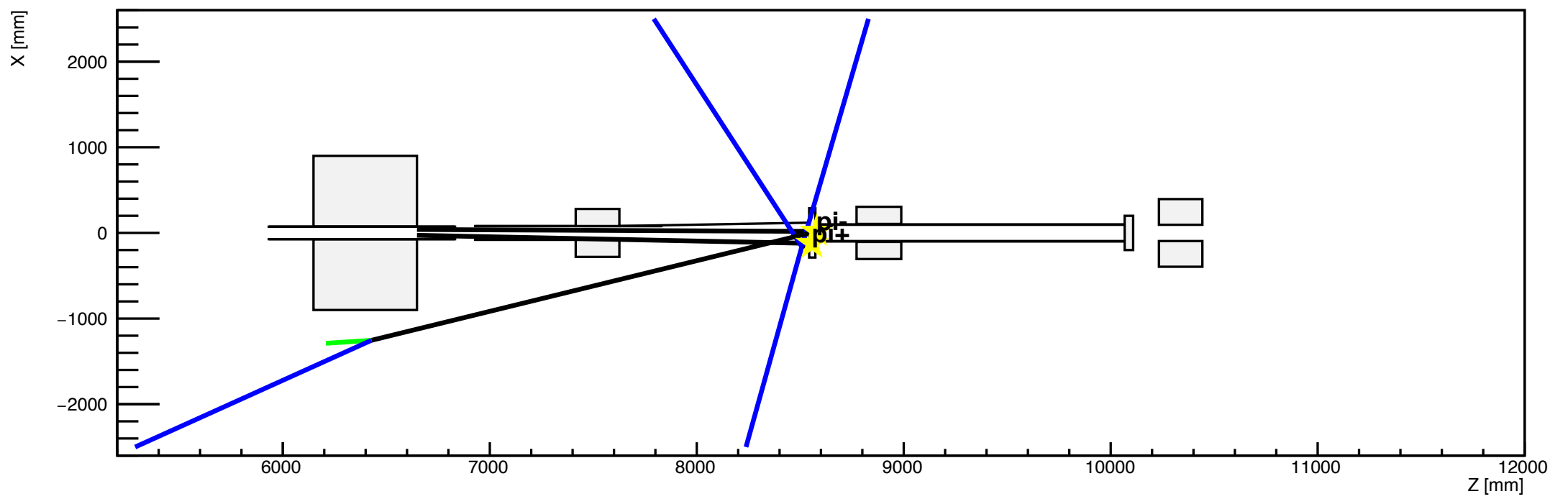

h1

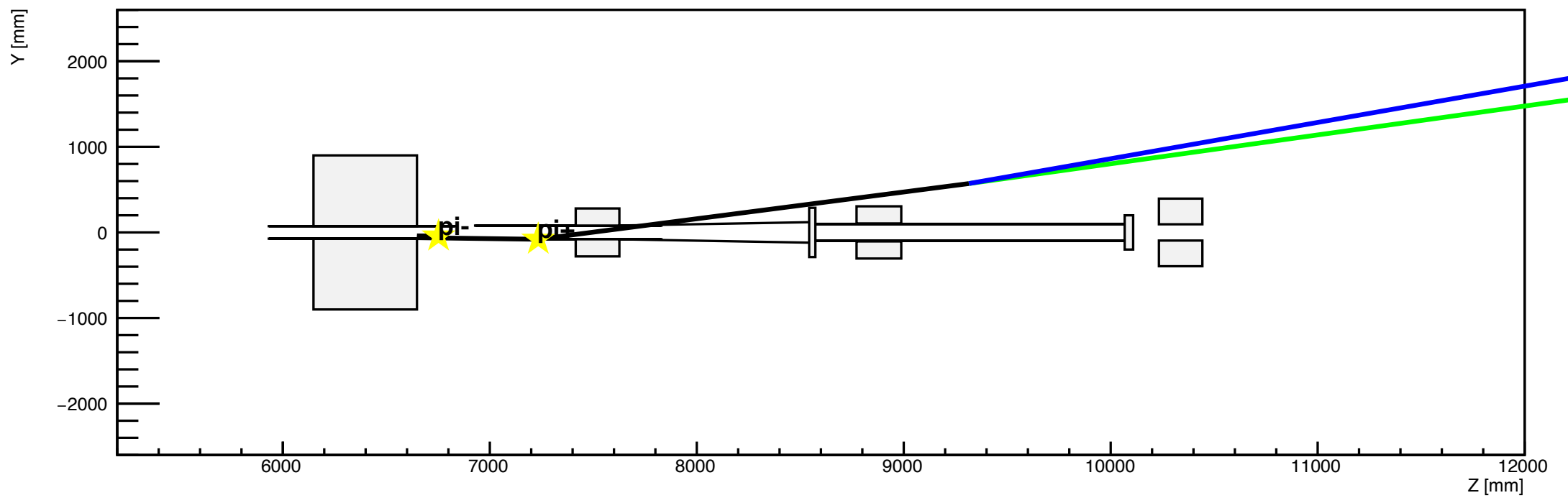

h2

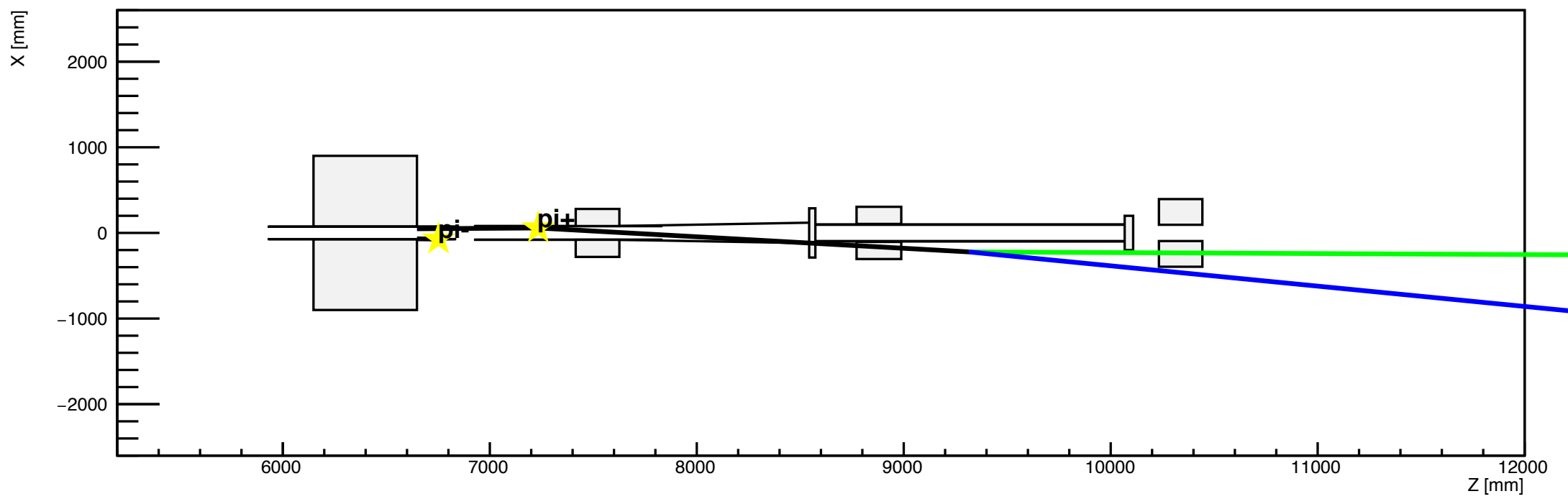

h1

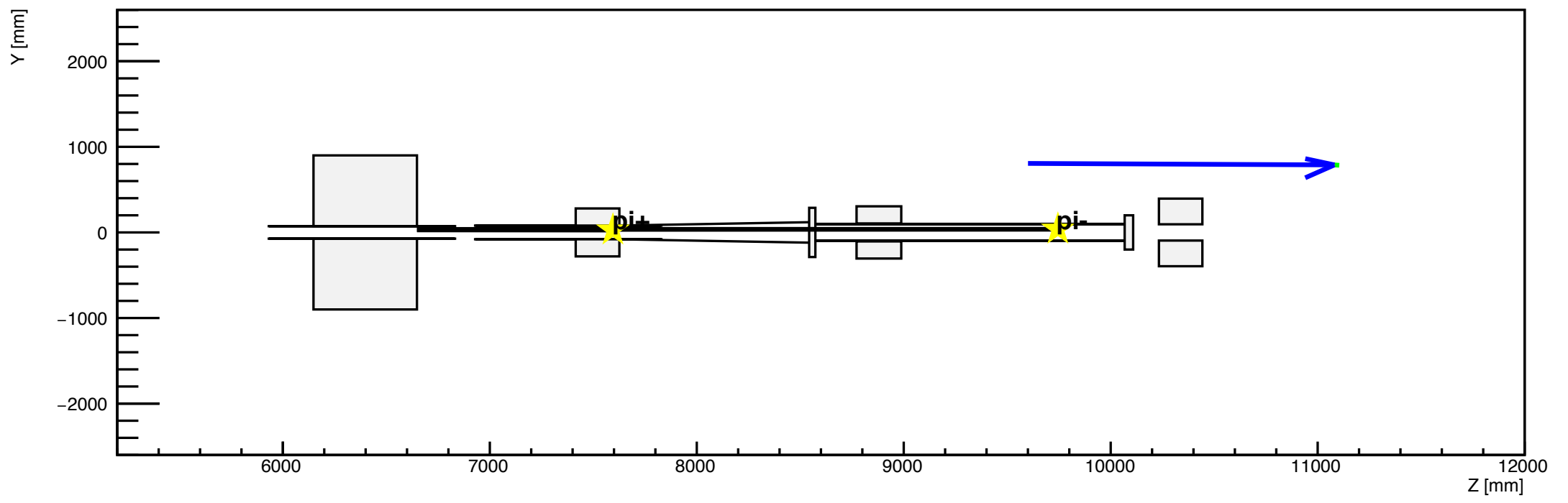

h2

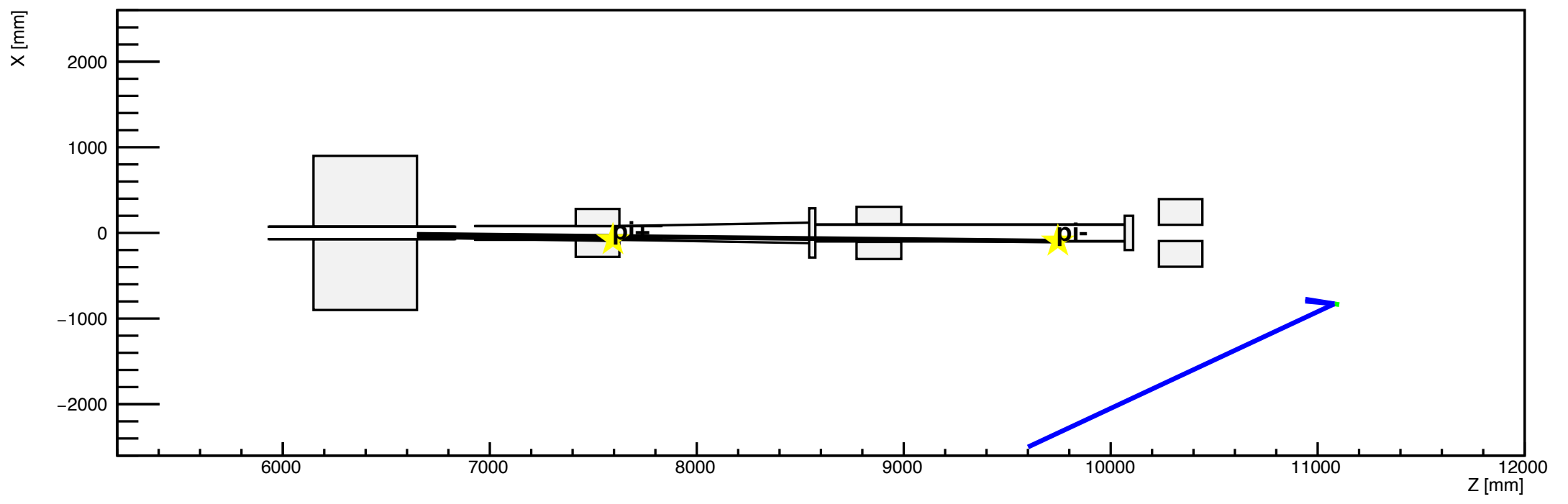

h1

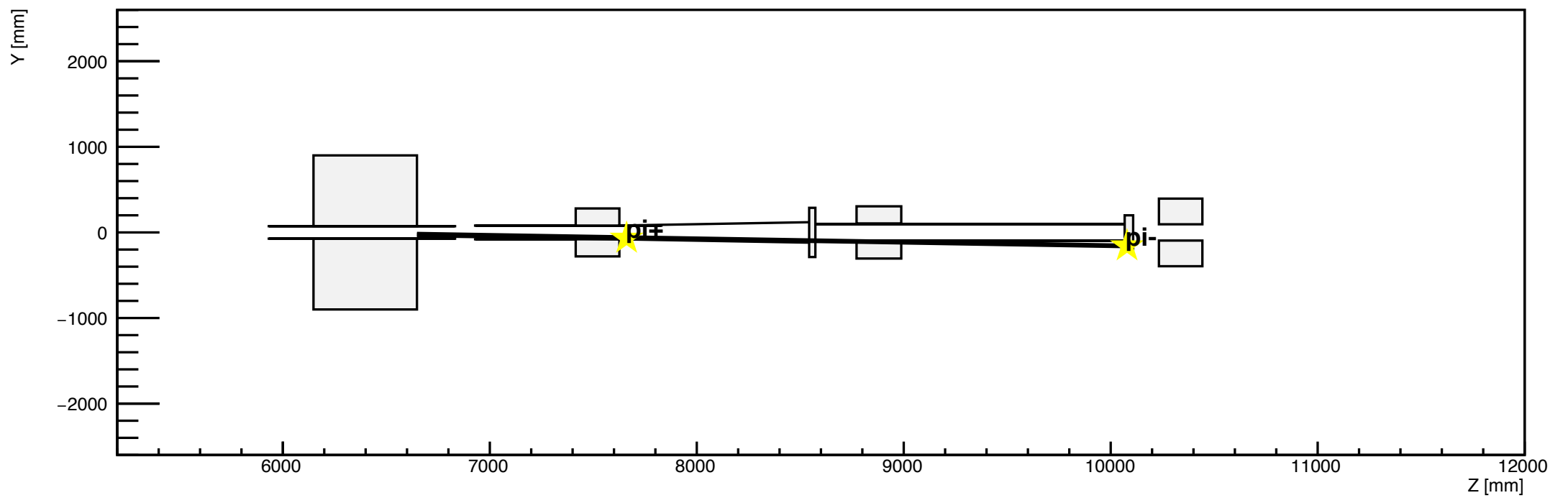

h2

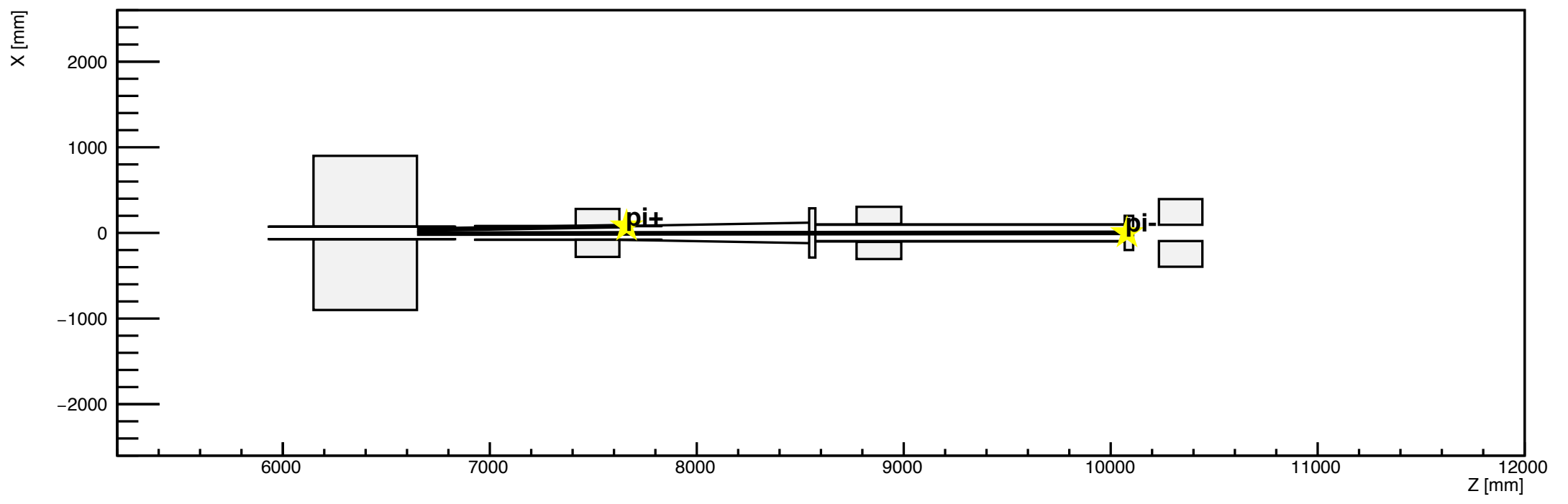

h1

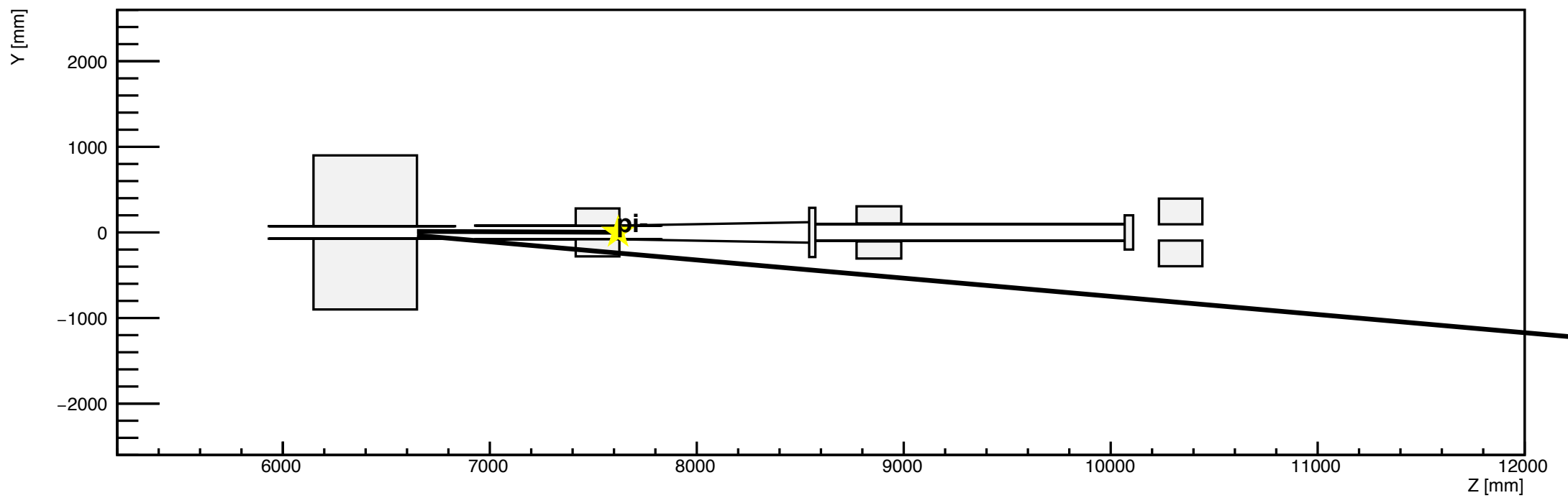

h2

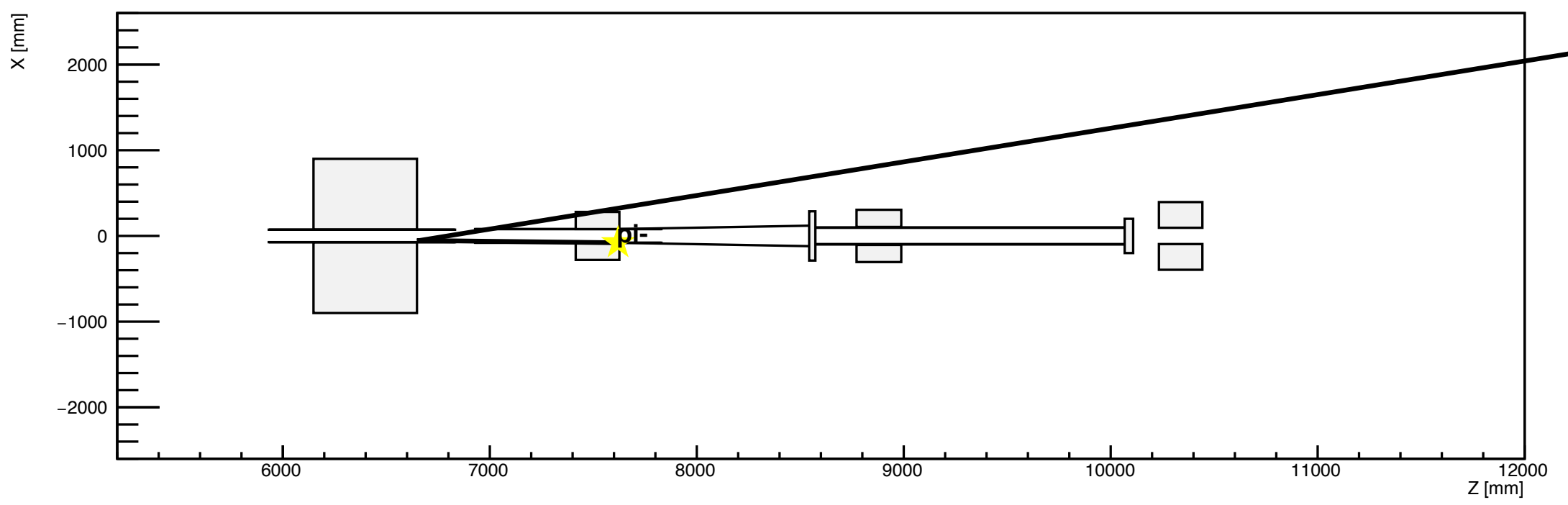

h1

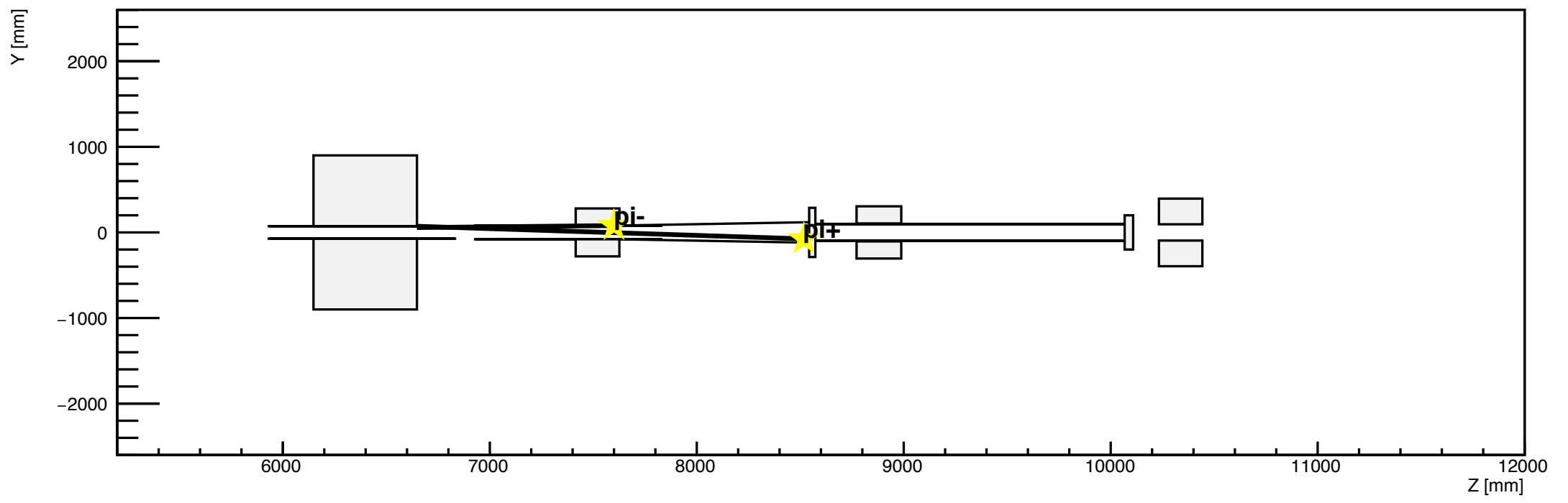

h2

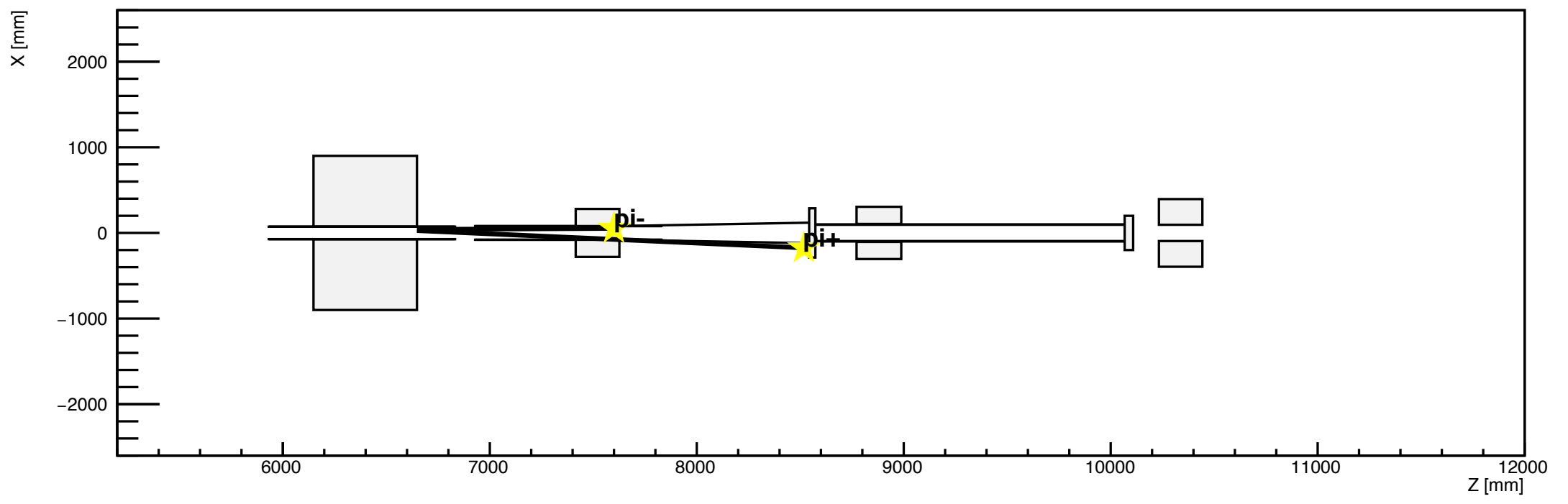

h1

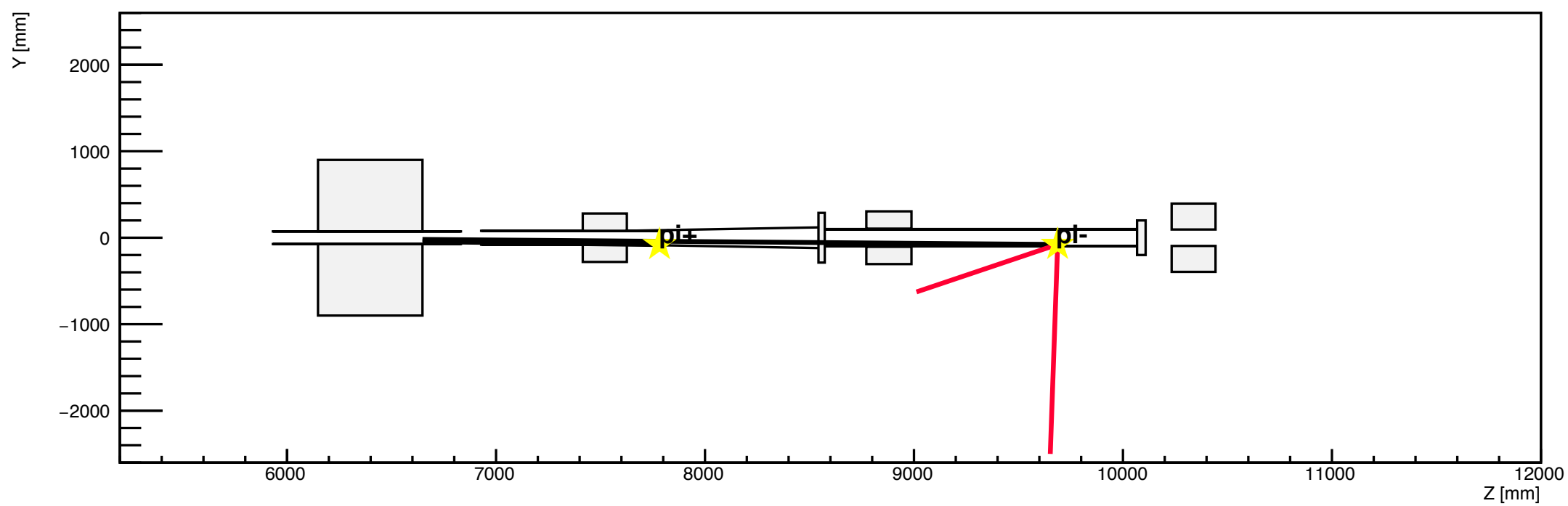

h2

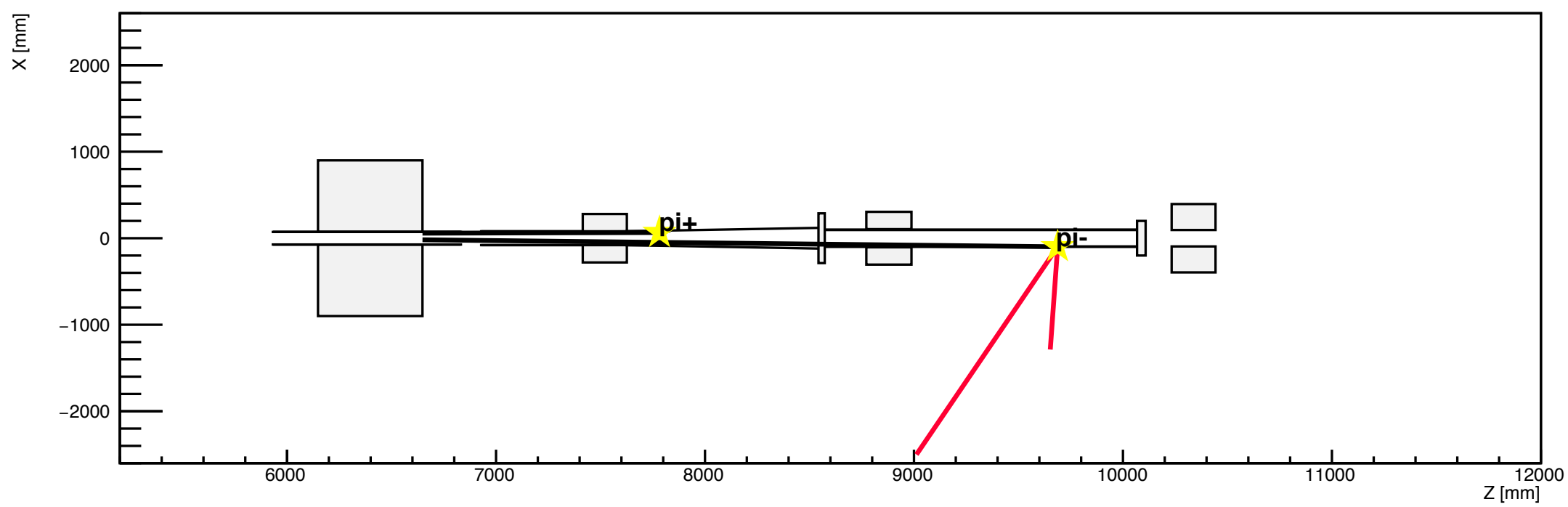

h1

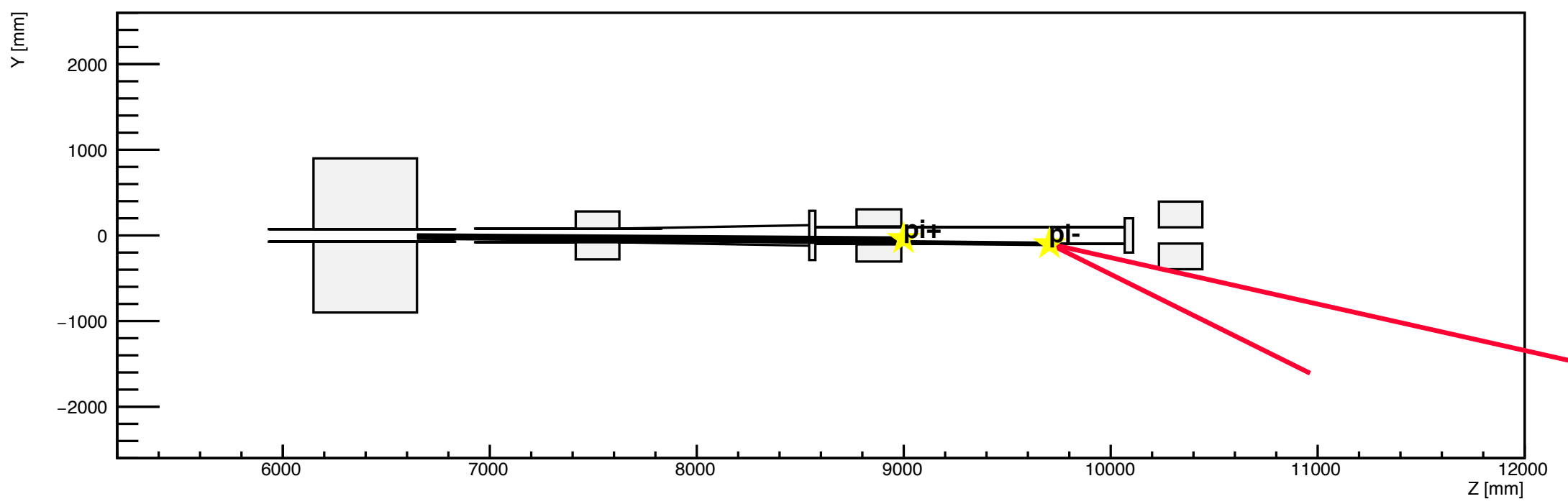

h2

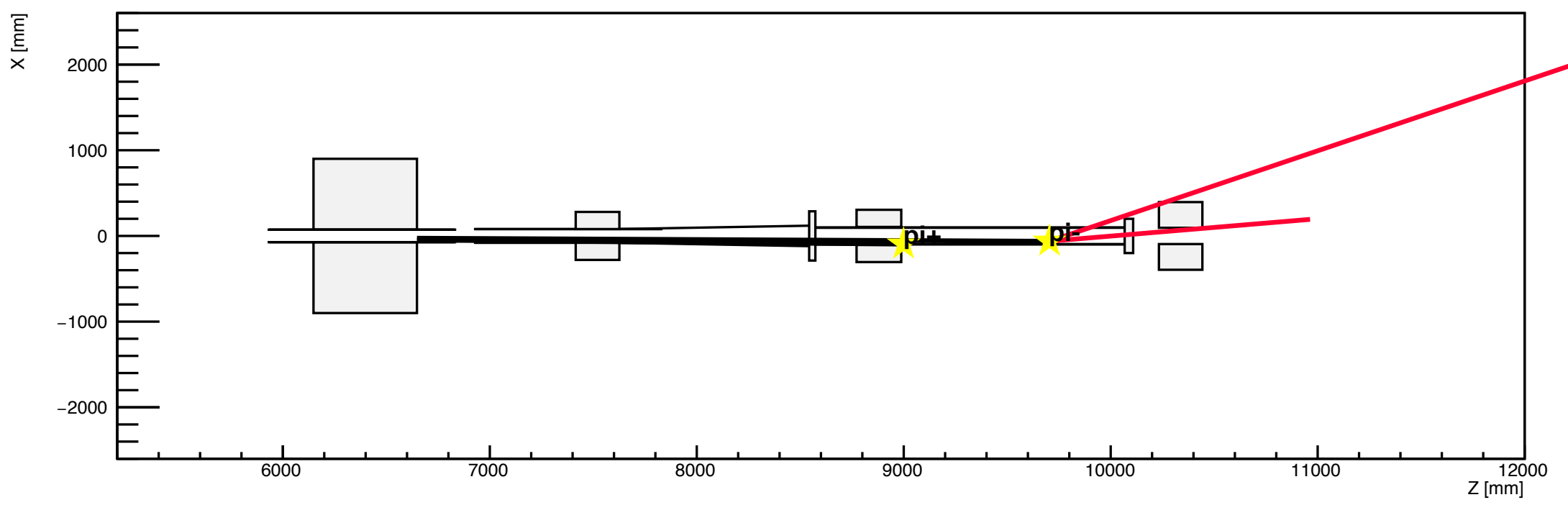

h1

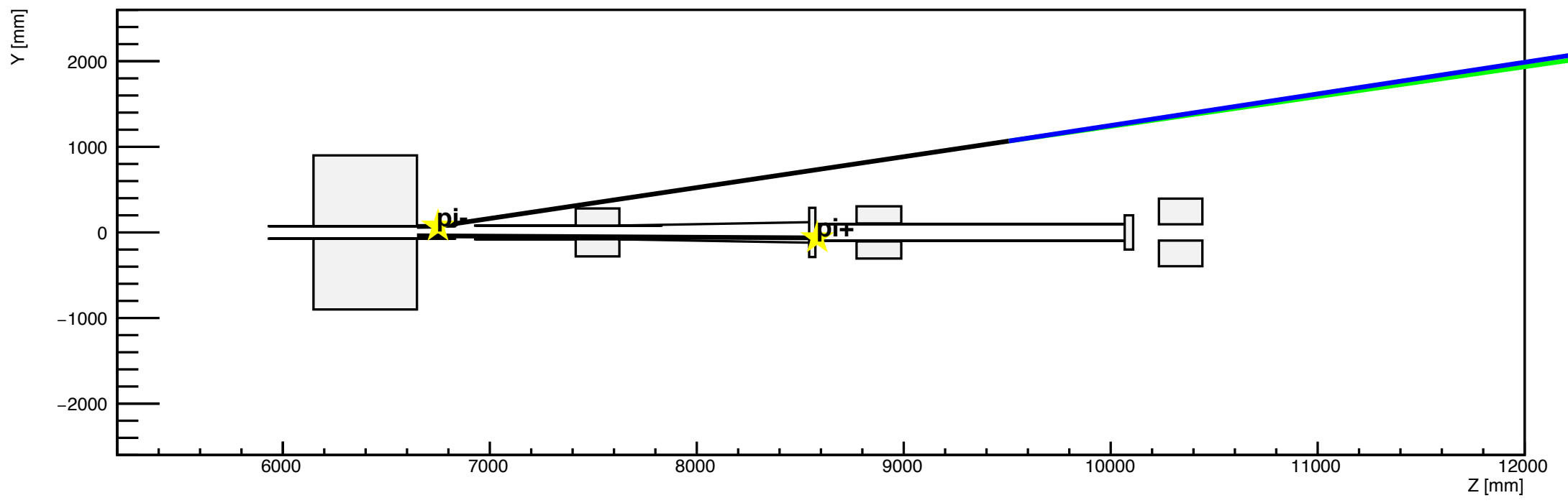

h2

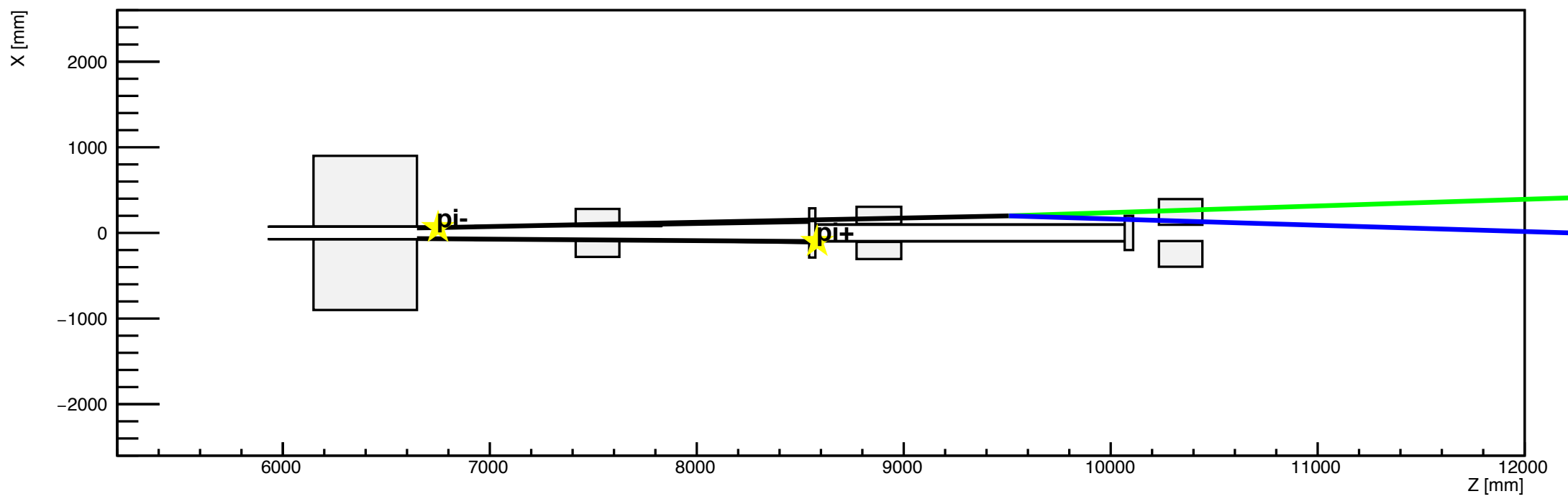

h1

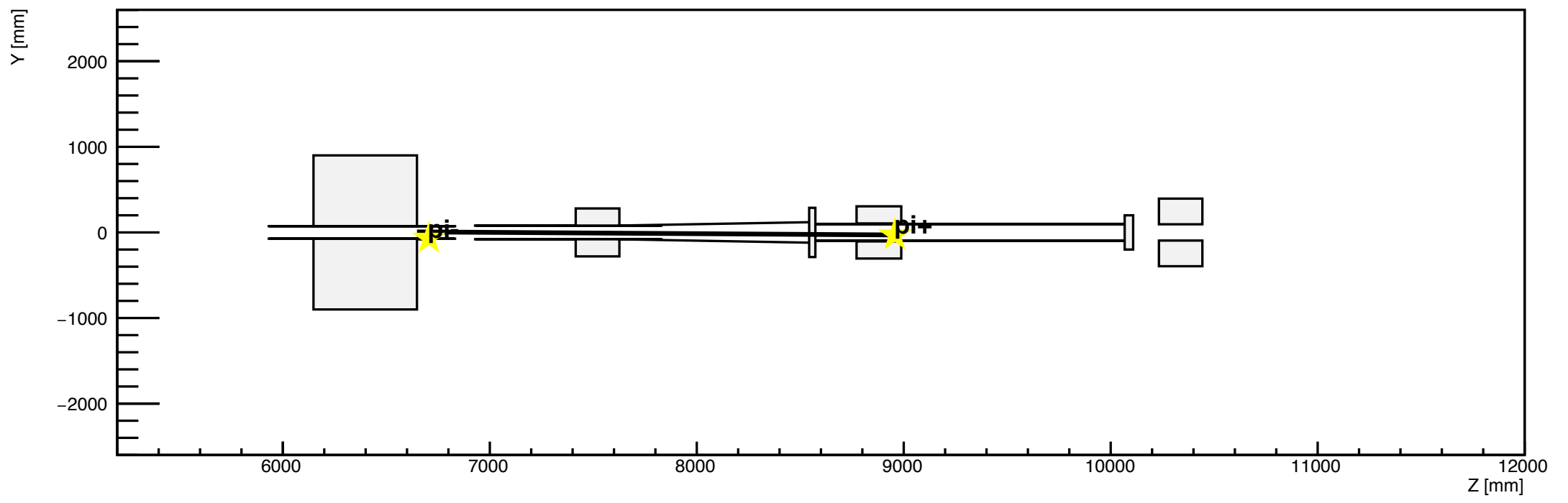

h2

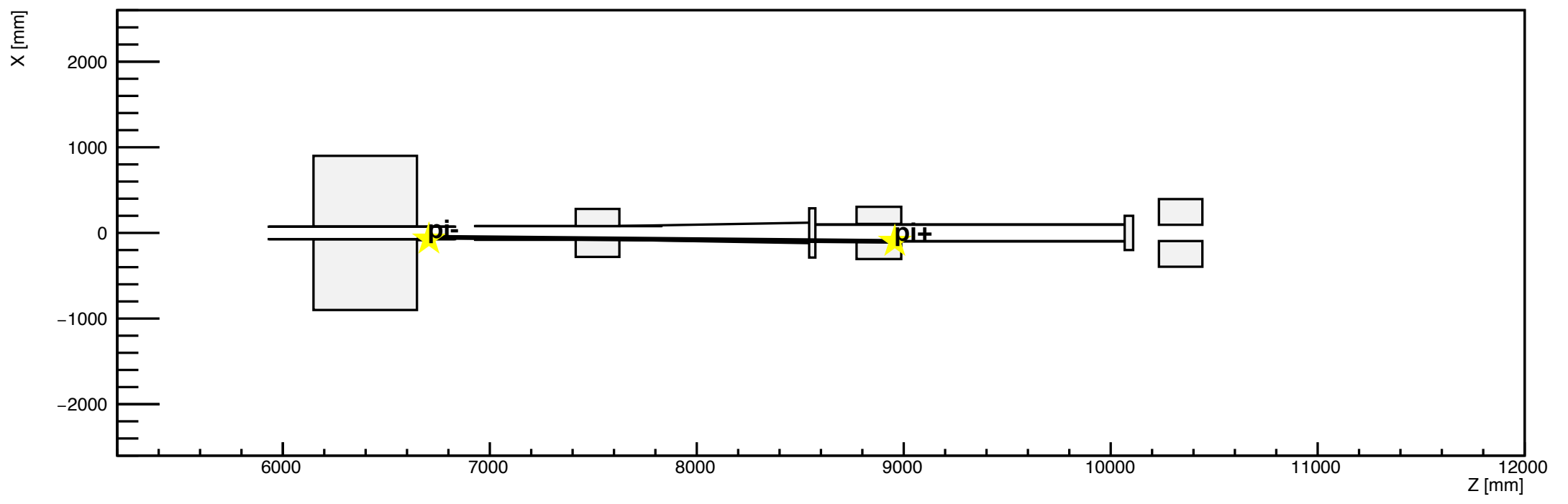

h1

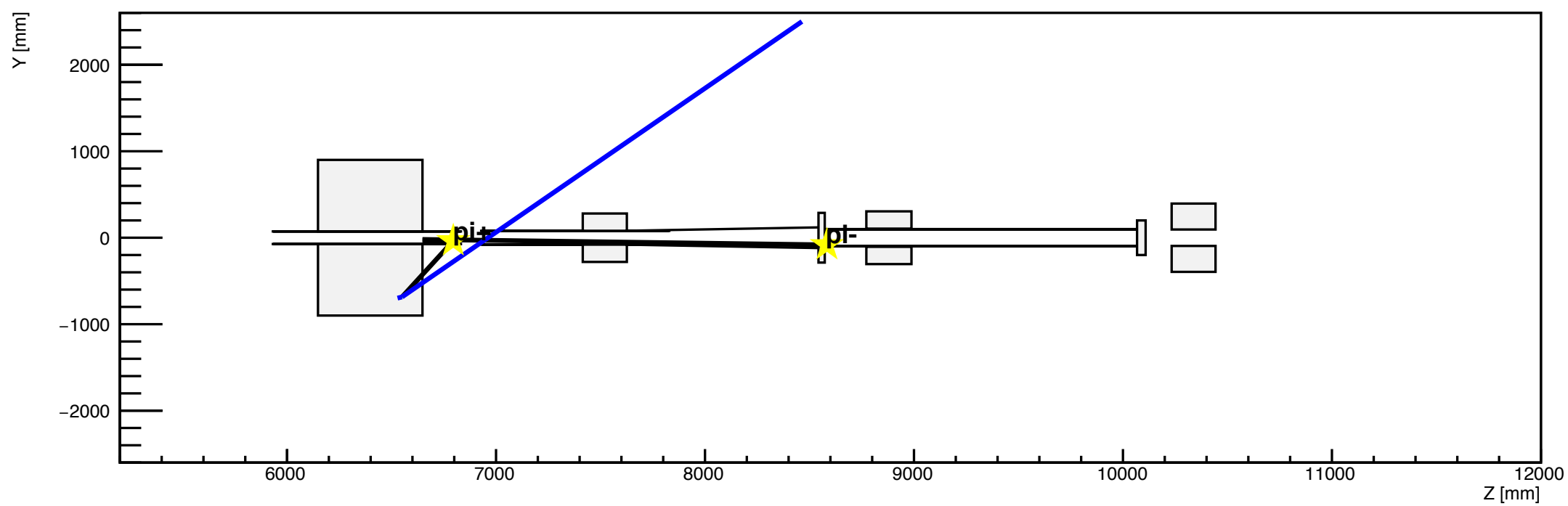

h2

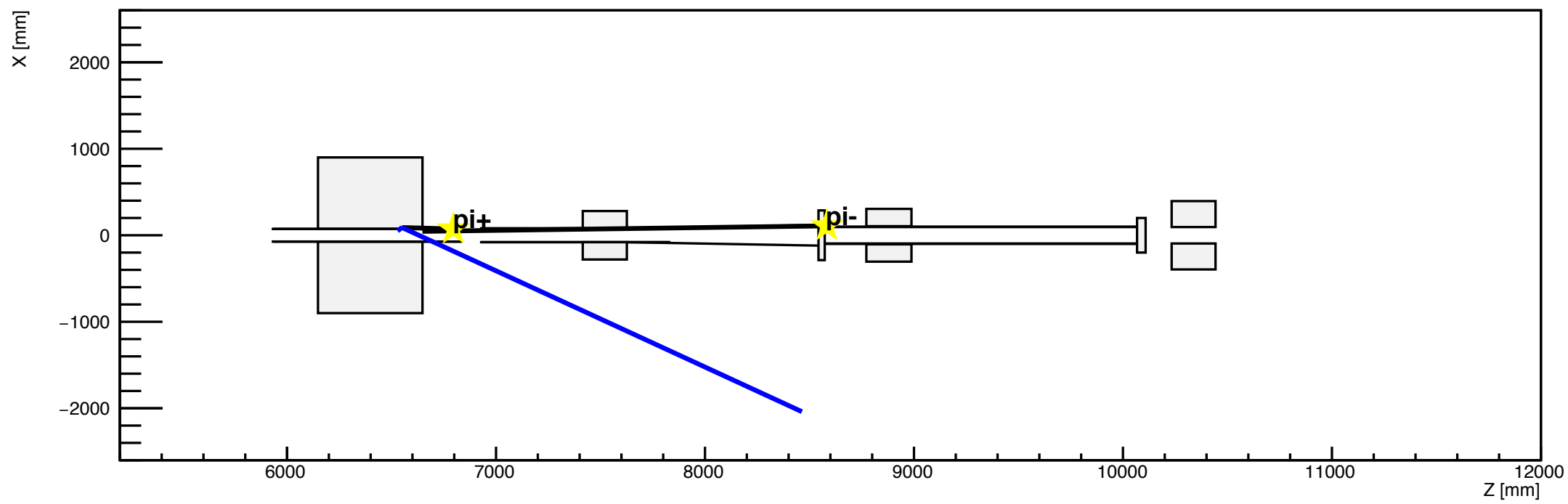

h1

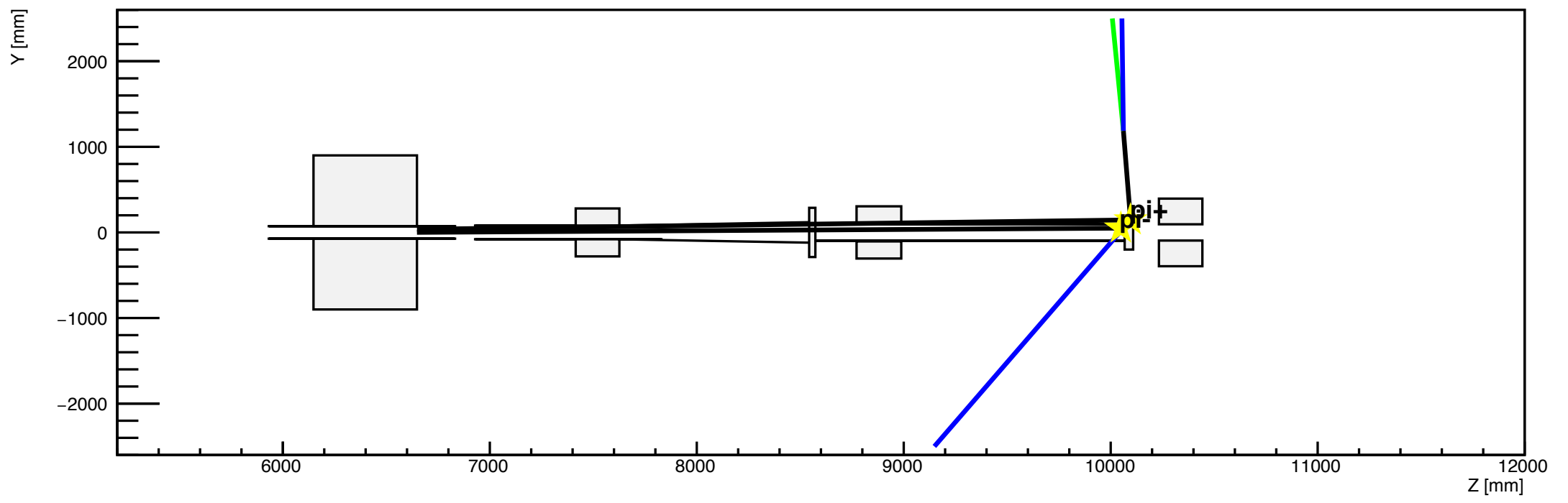

h2

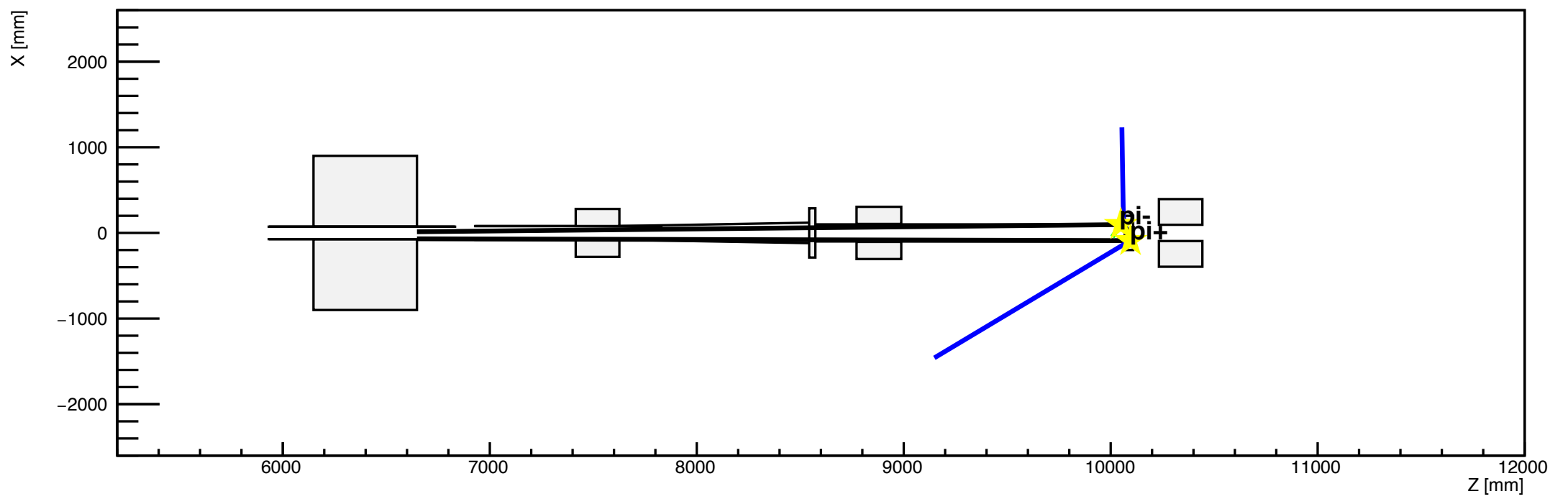

h1

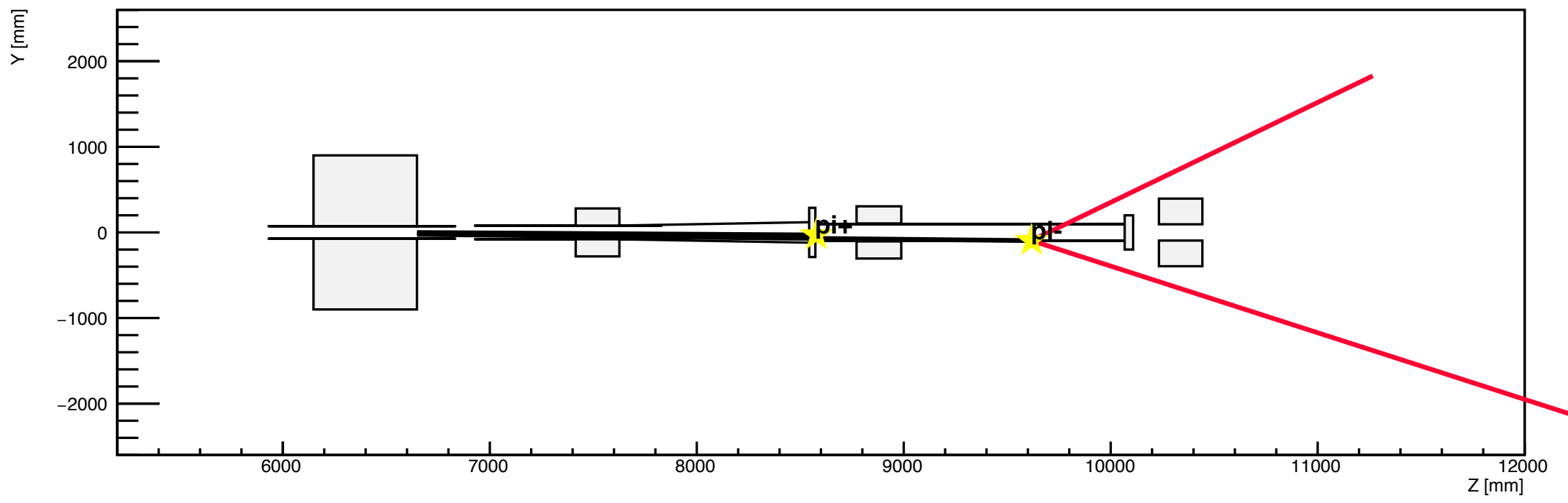

h2

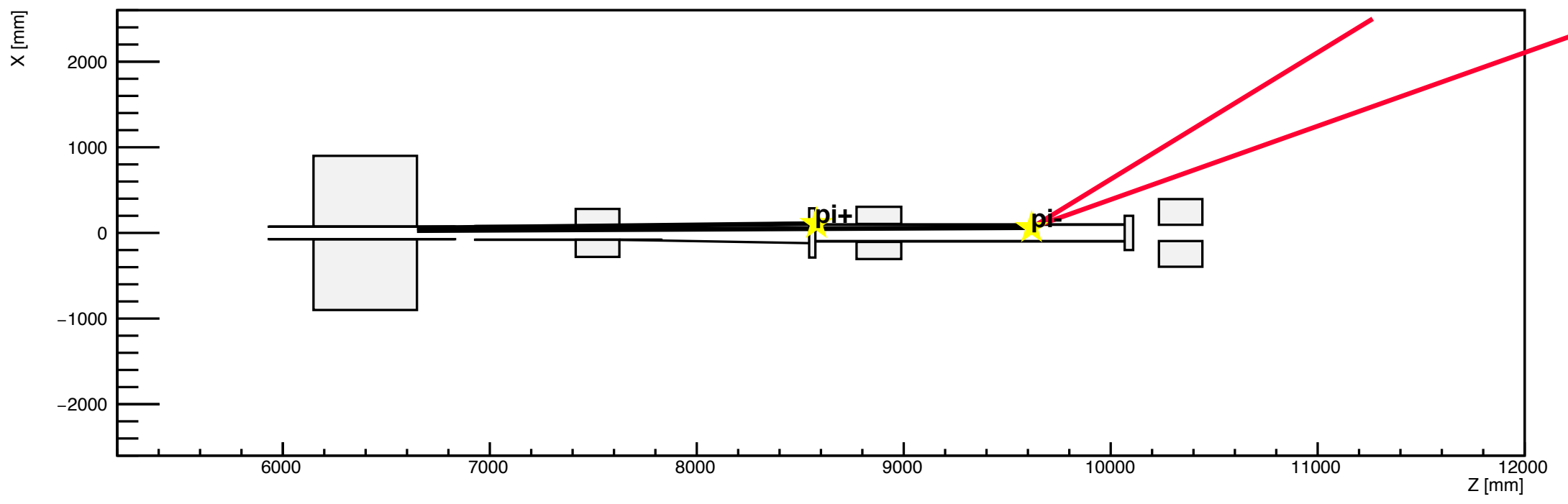

h1

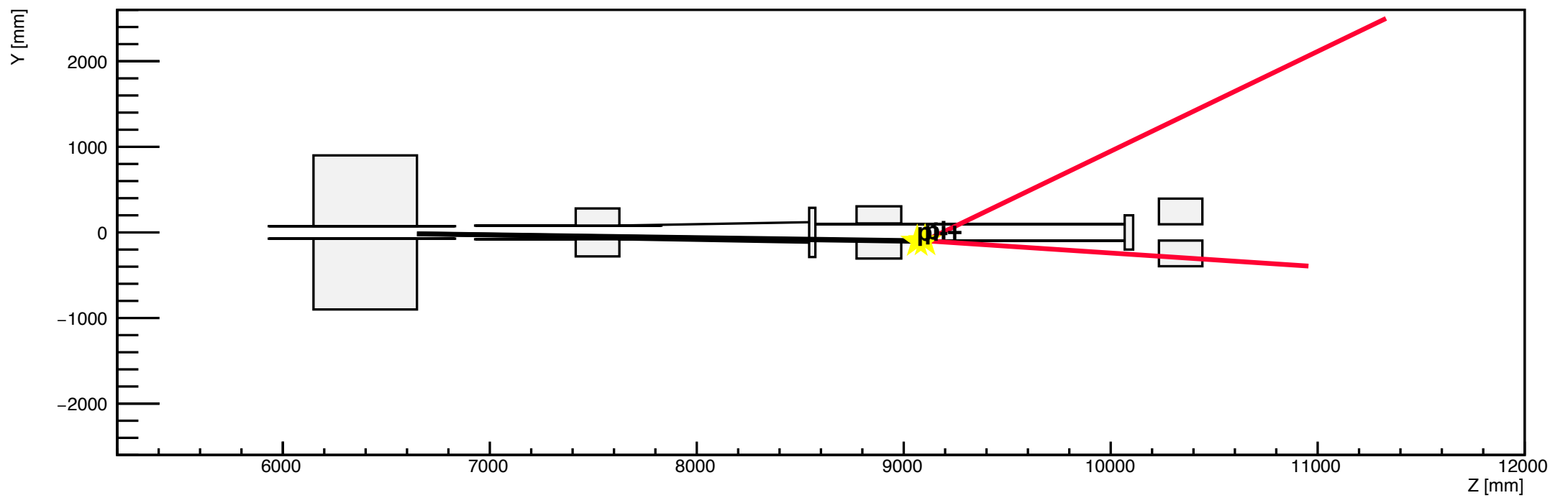

h2

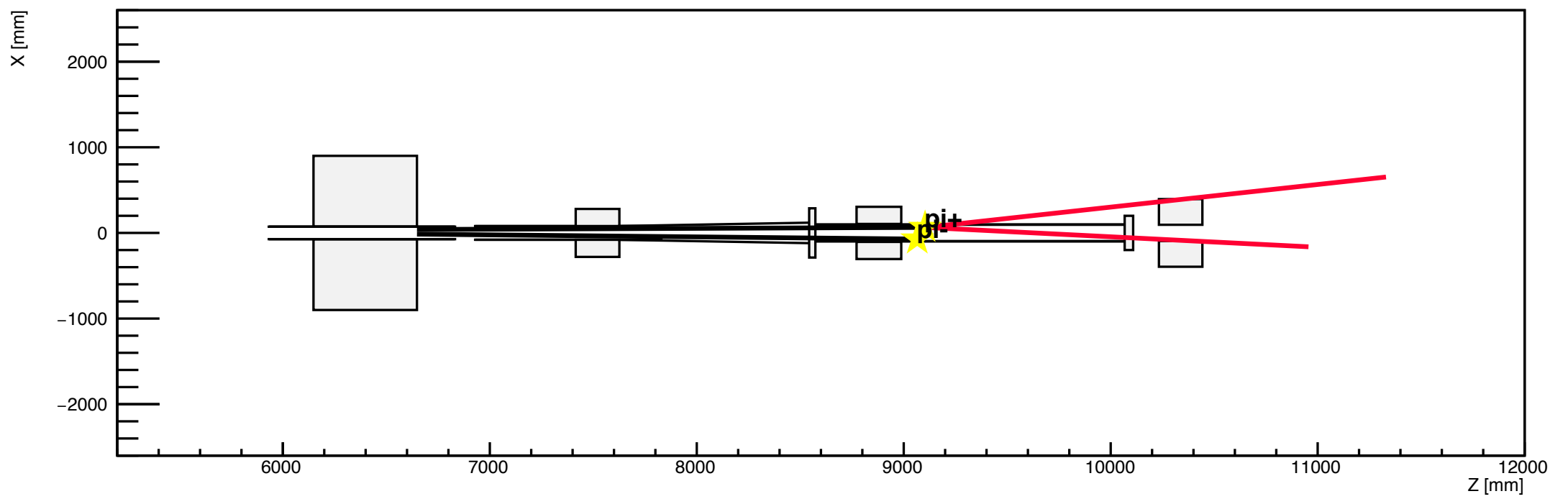

h1

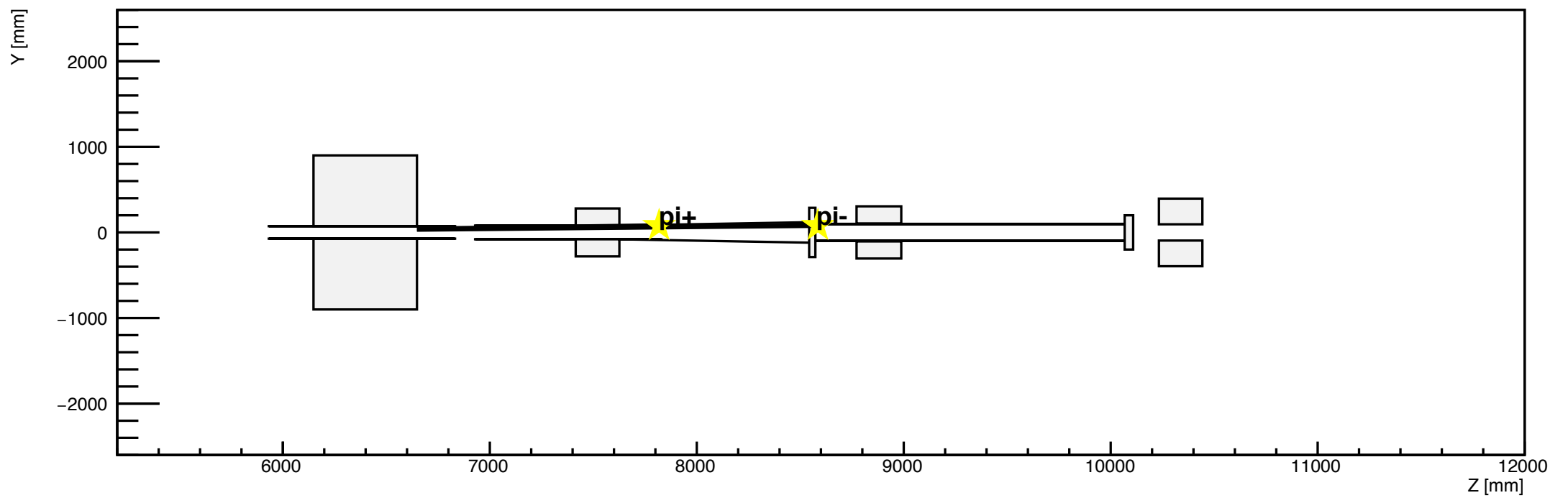

h2

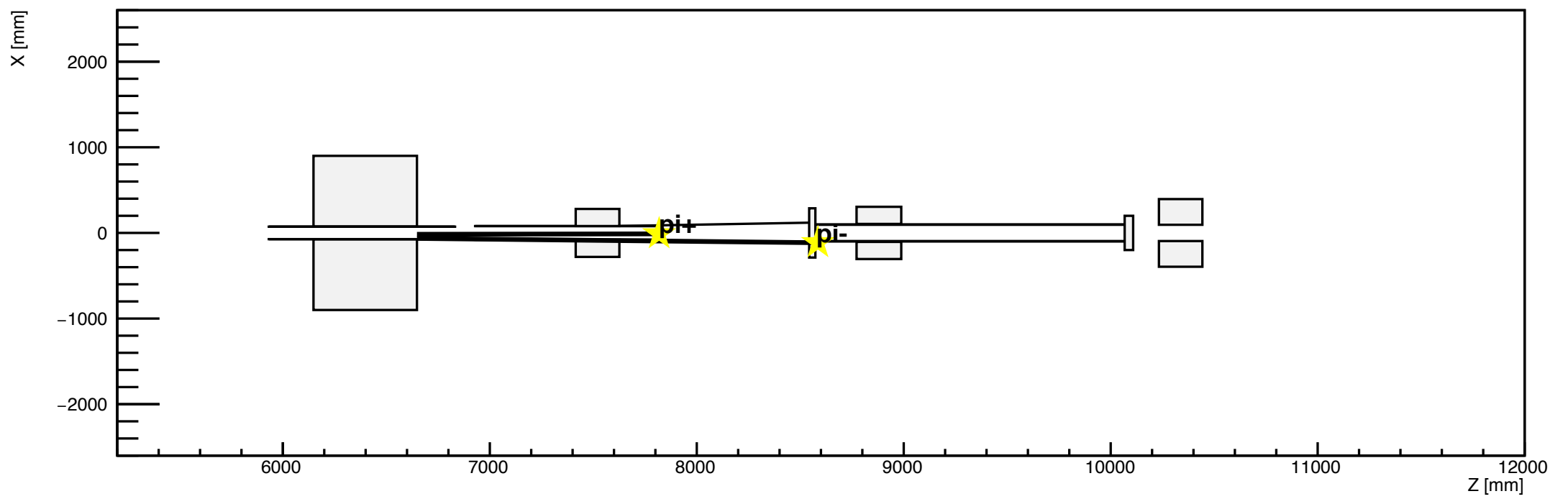

h1

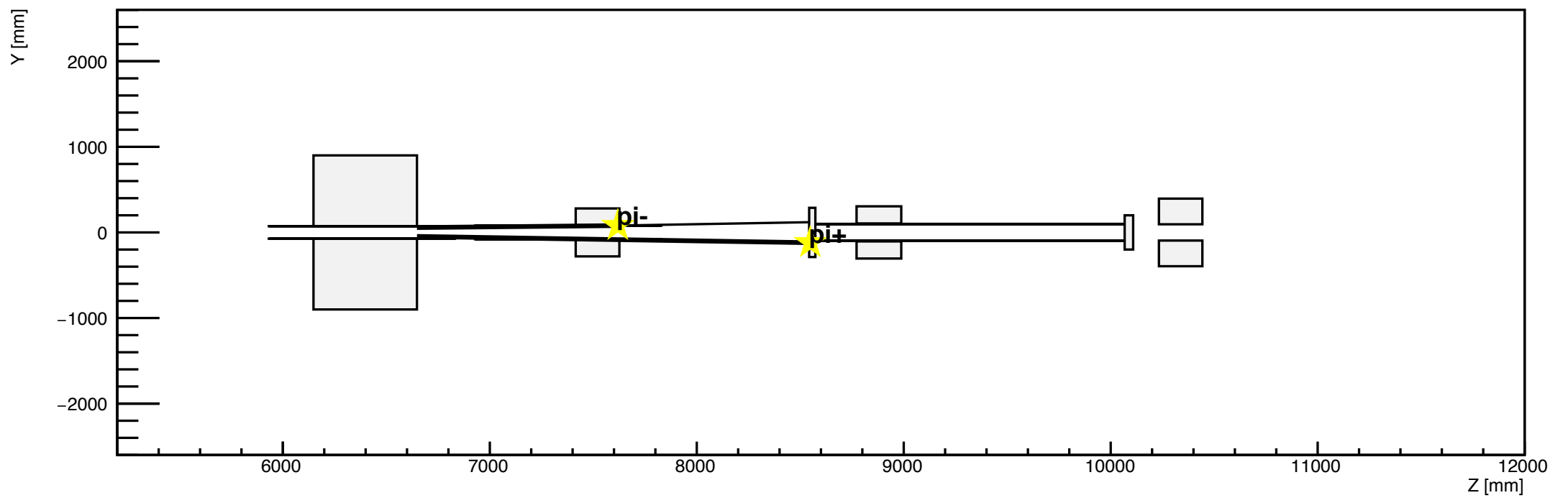

h2

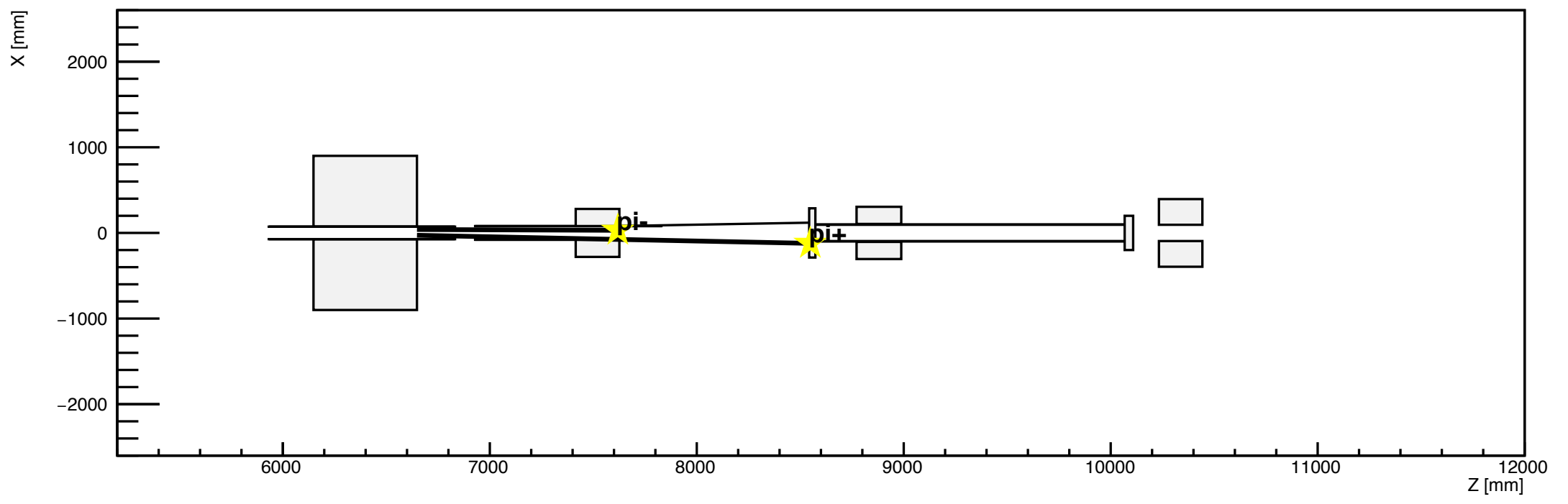

h1

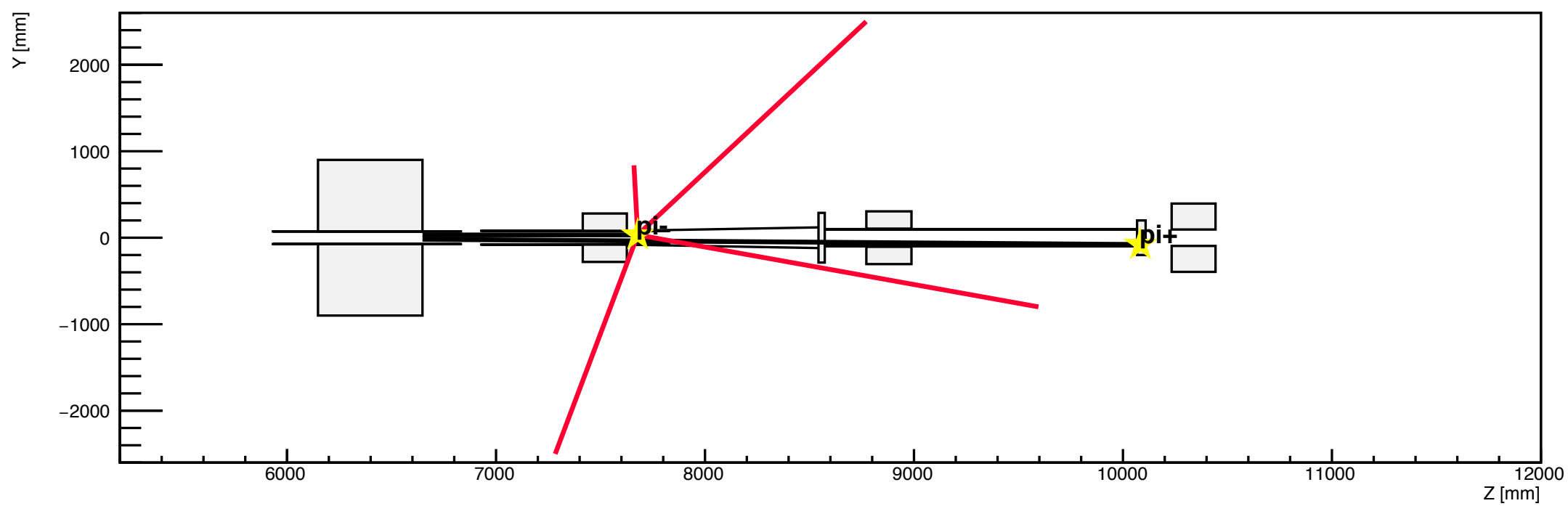

h2

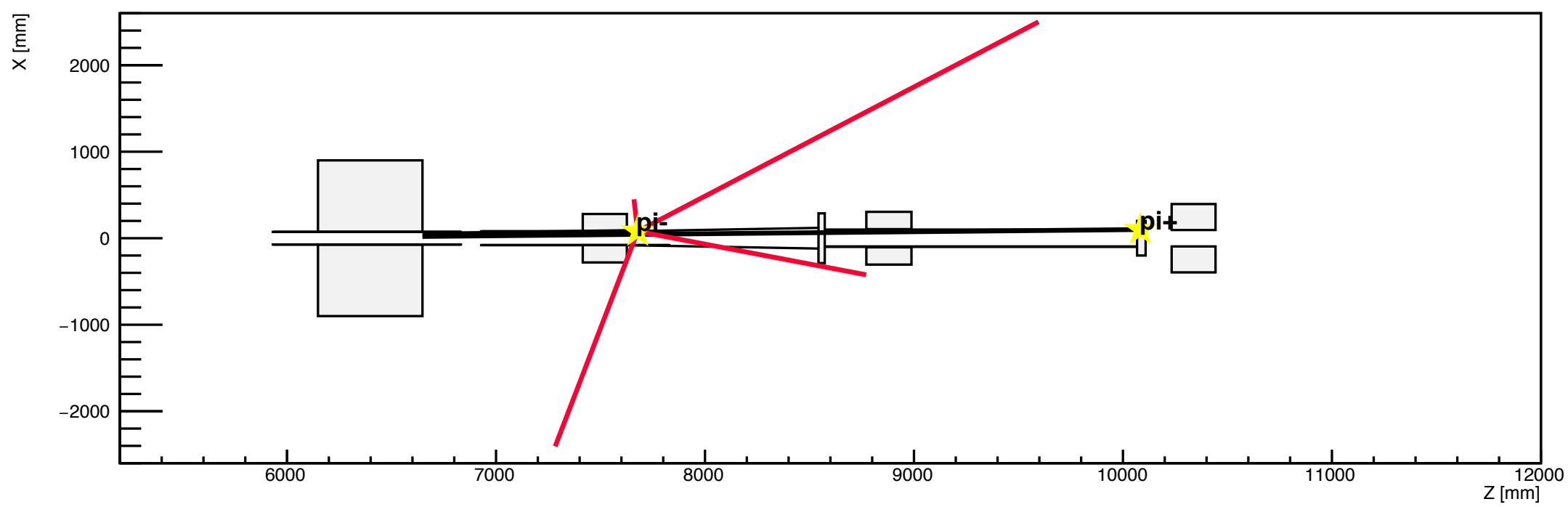

h1

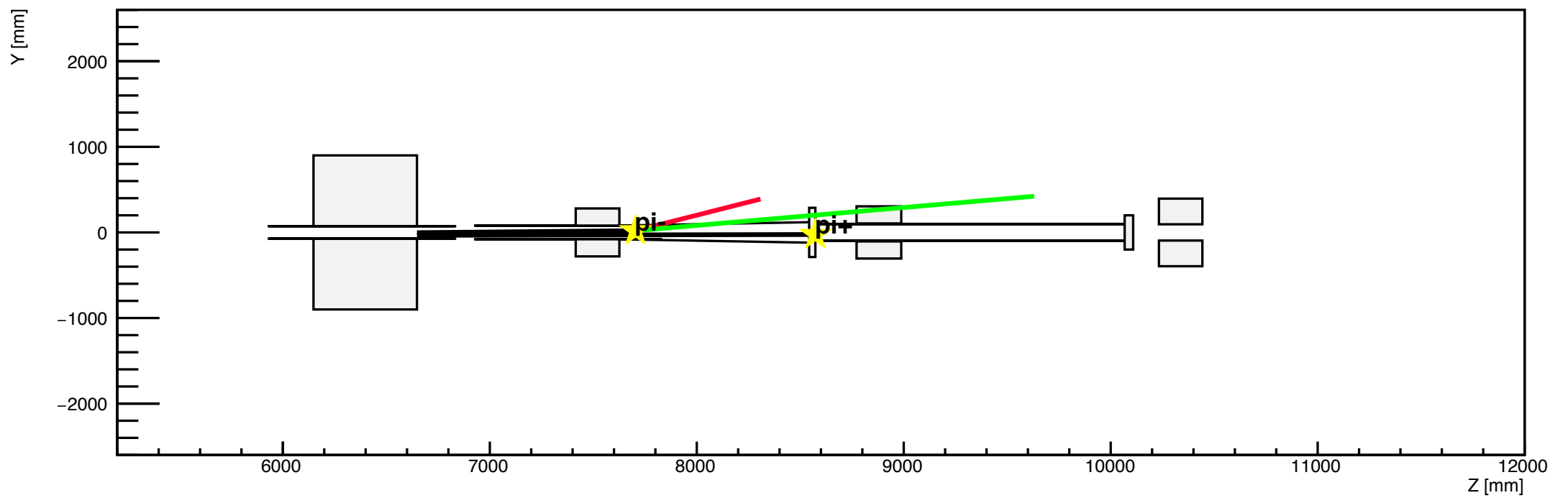

h2

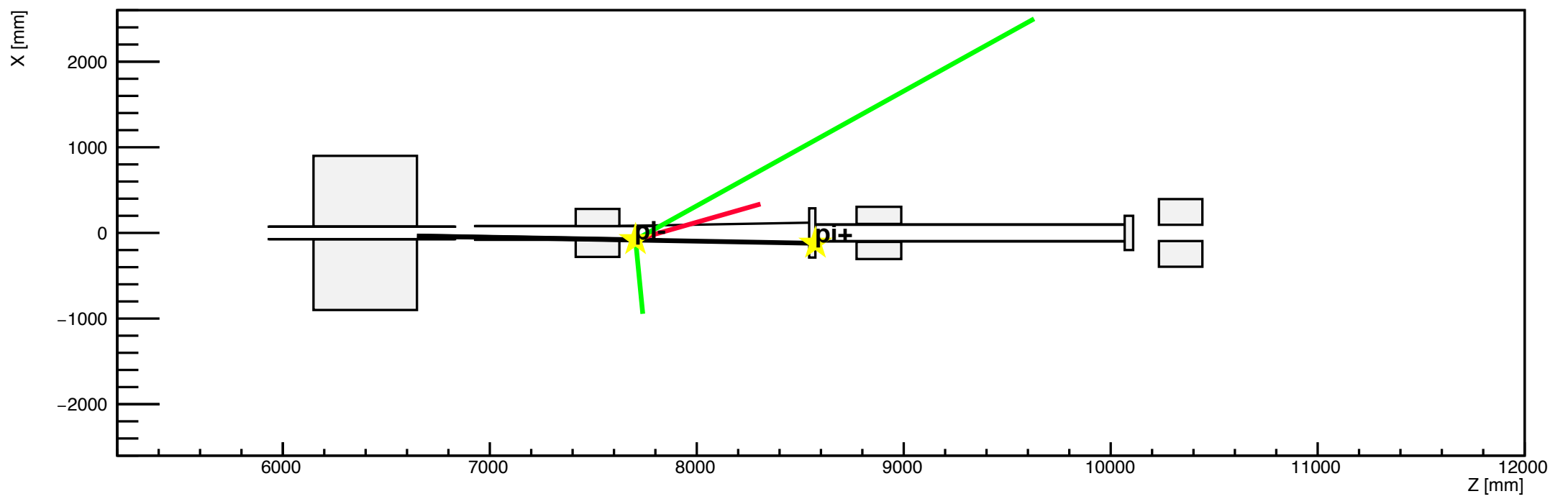

h1

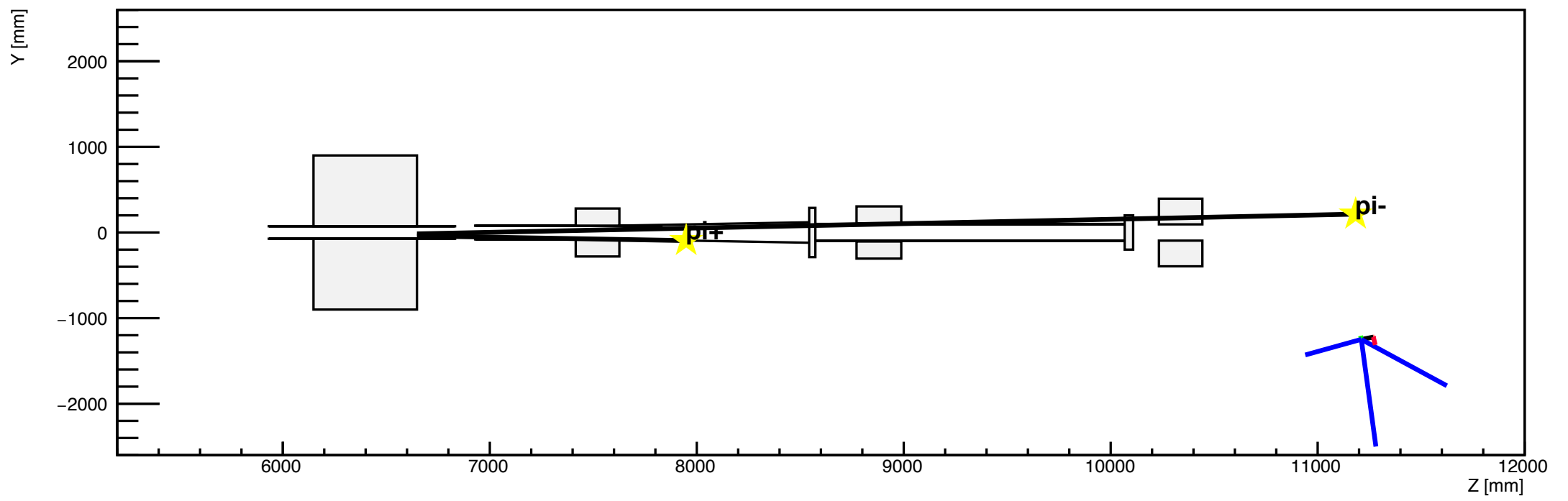

h2

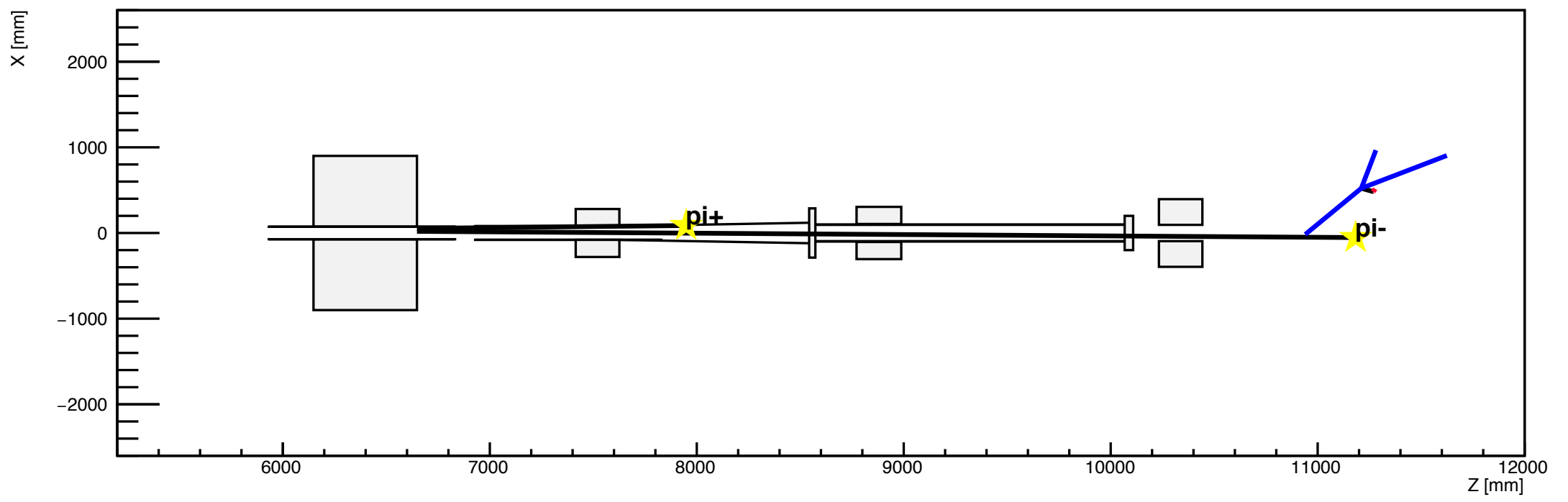

h1

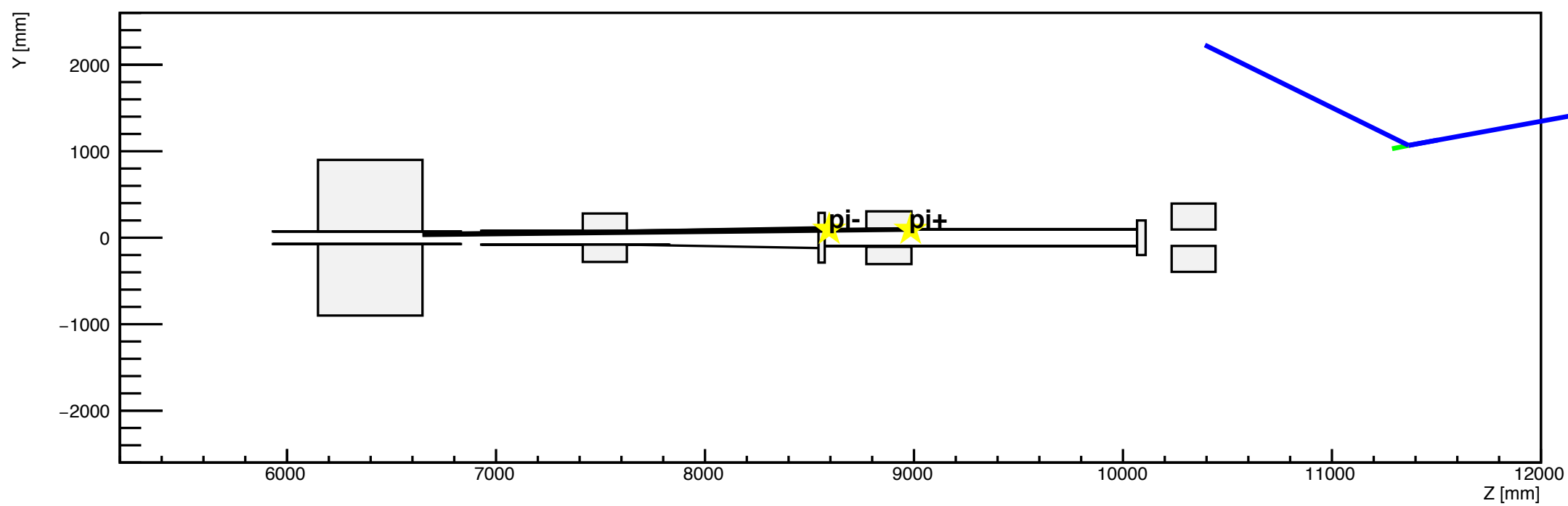

h2

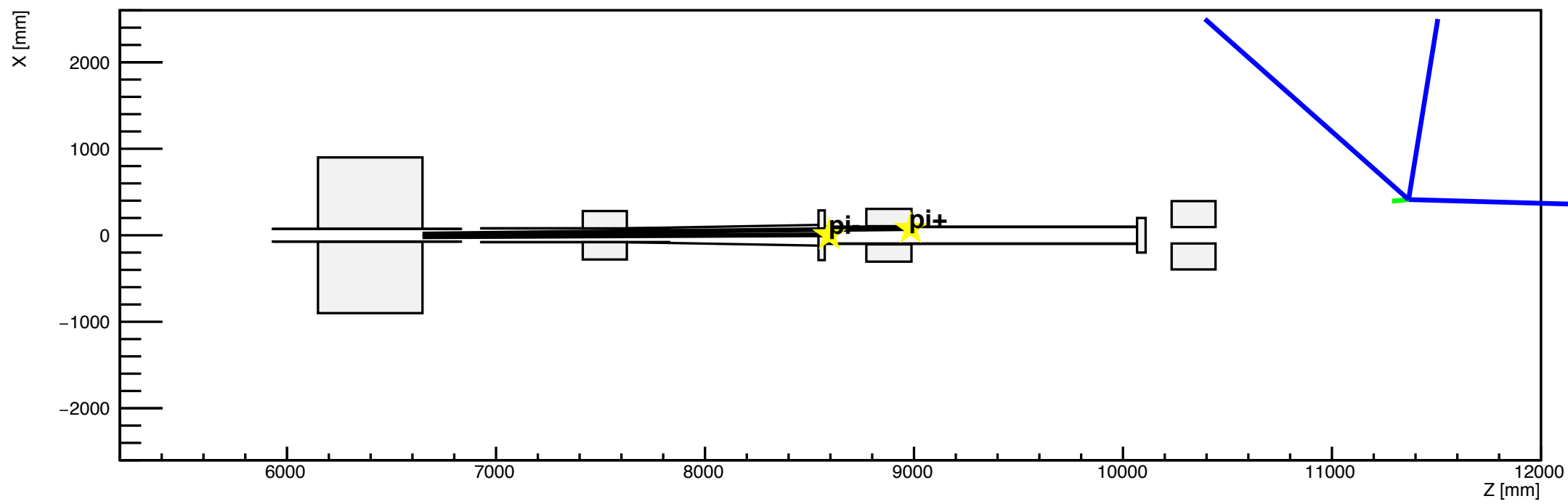

h1

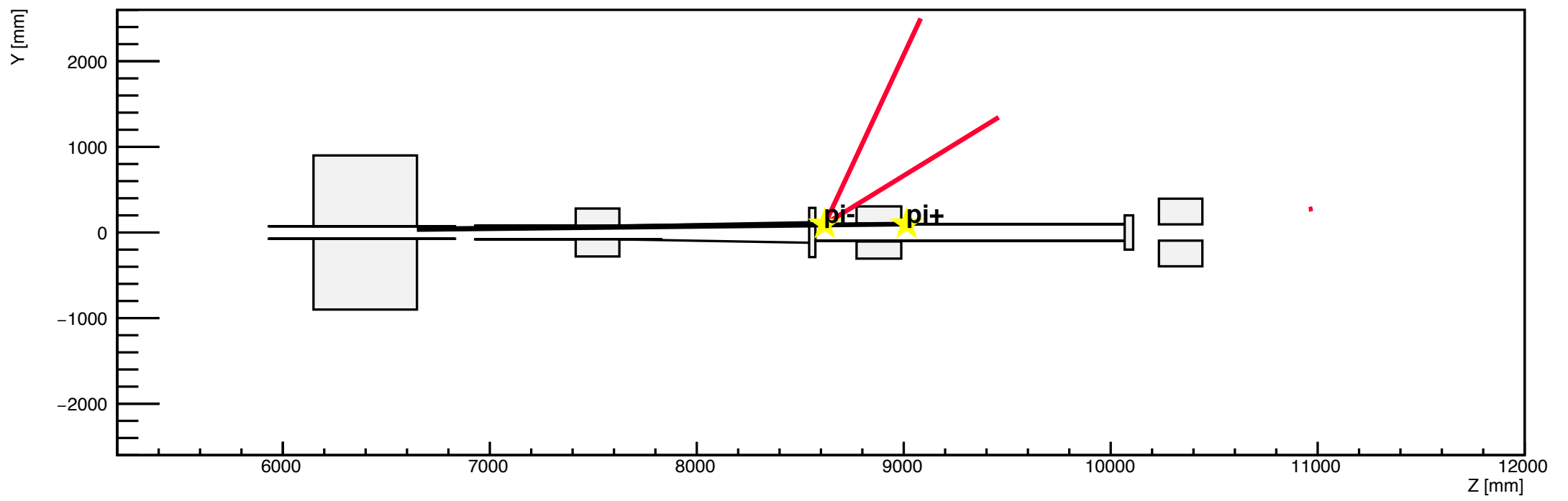

h2

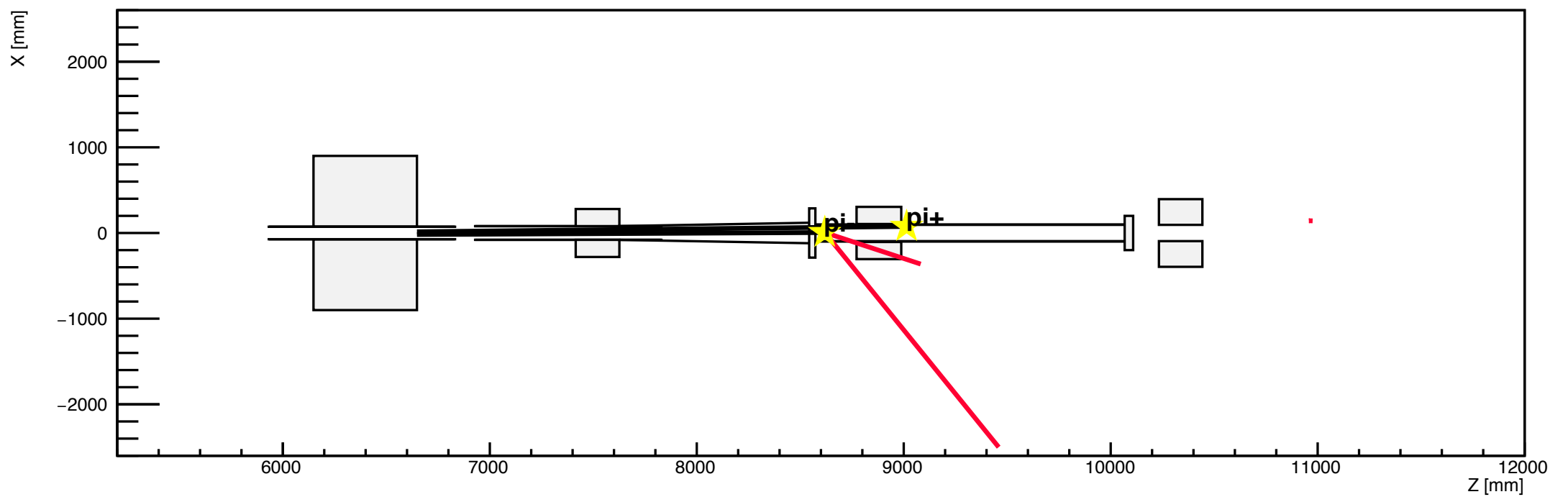

h1

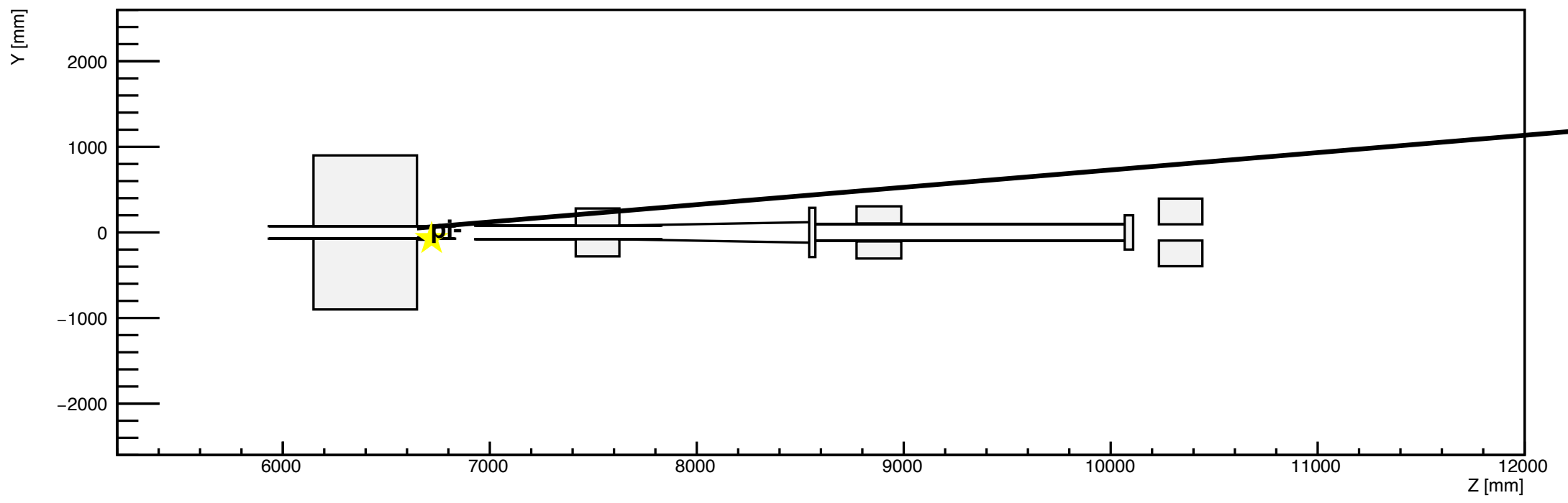

h2

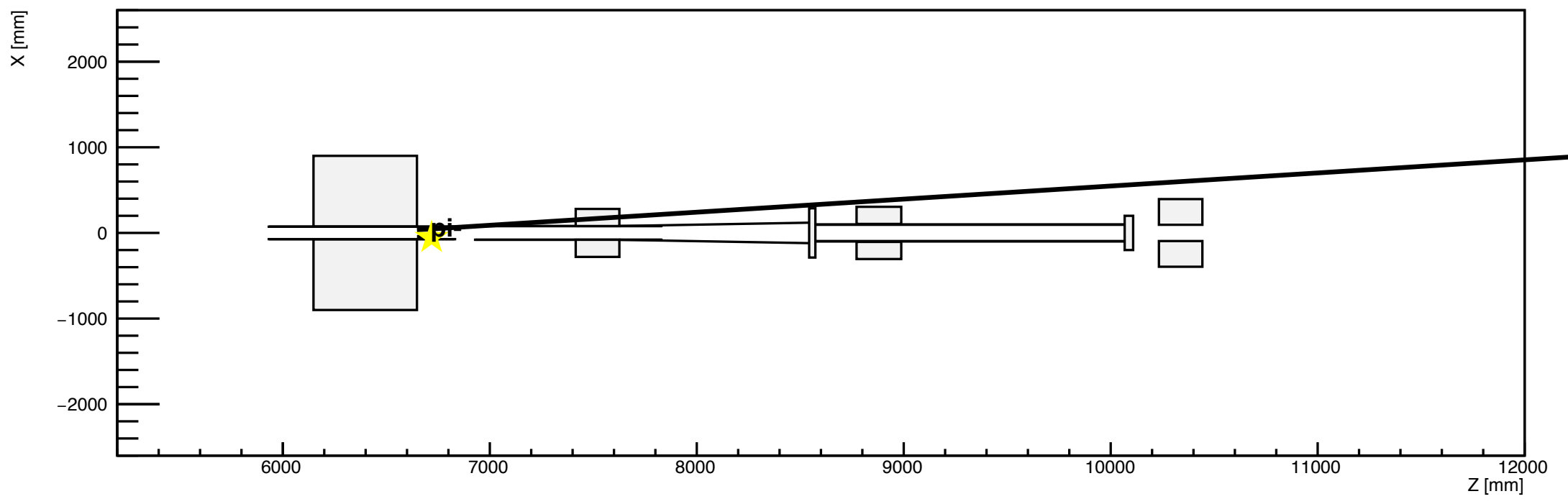

h1

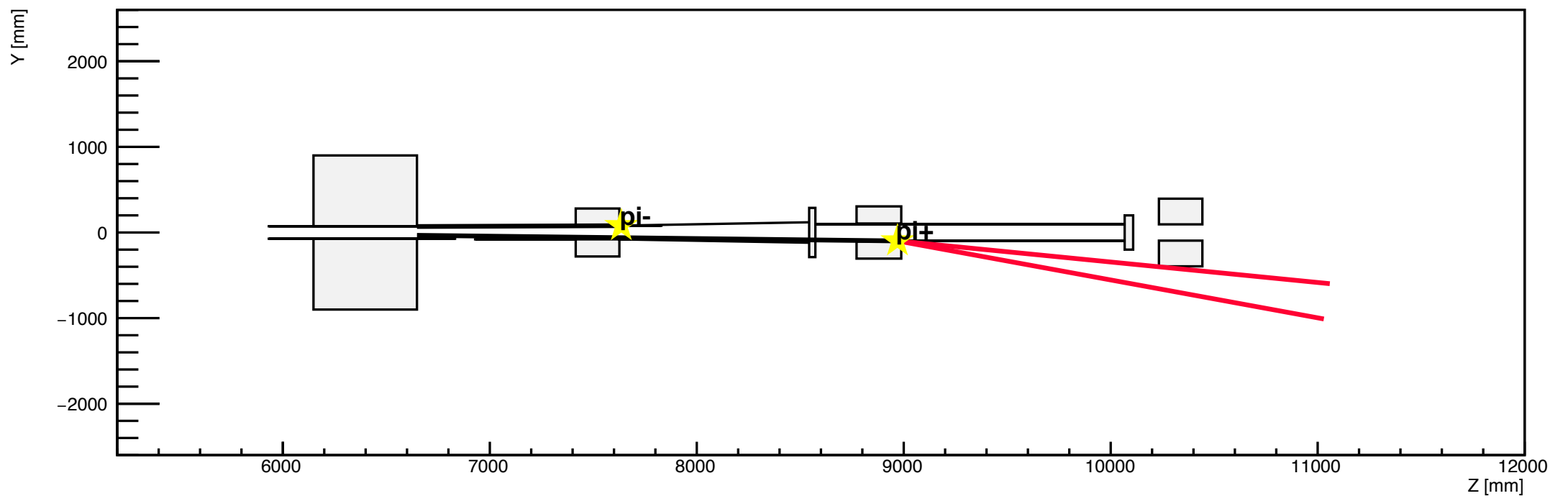

h2

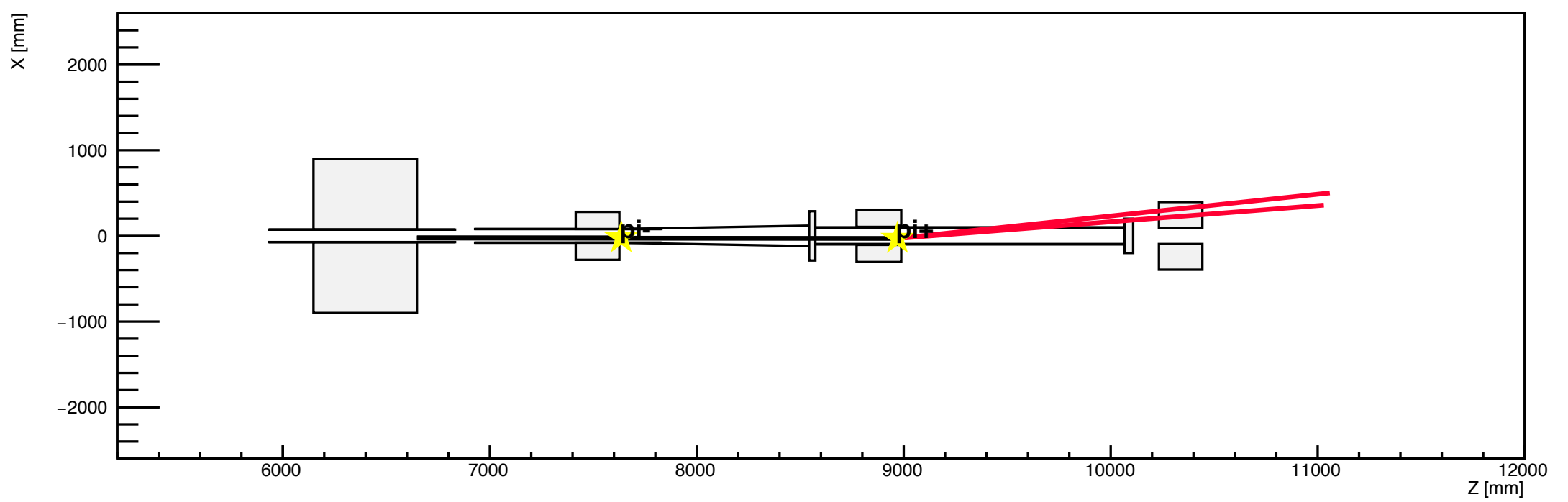

h1

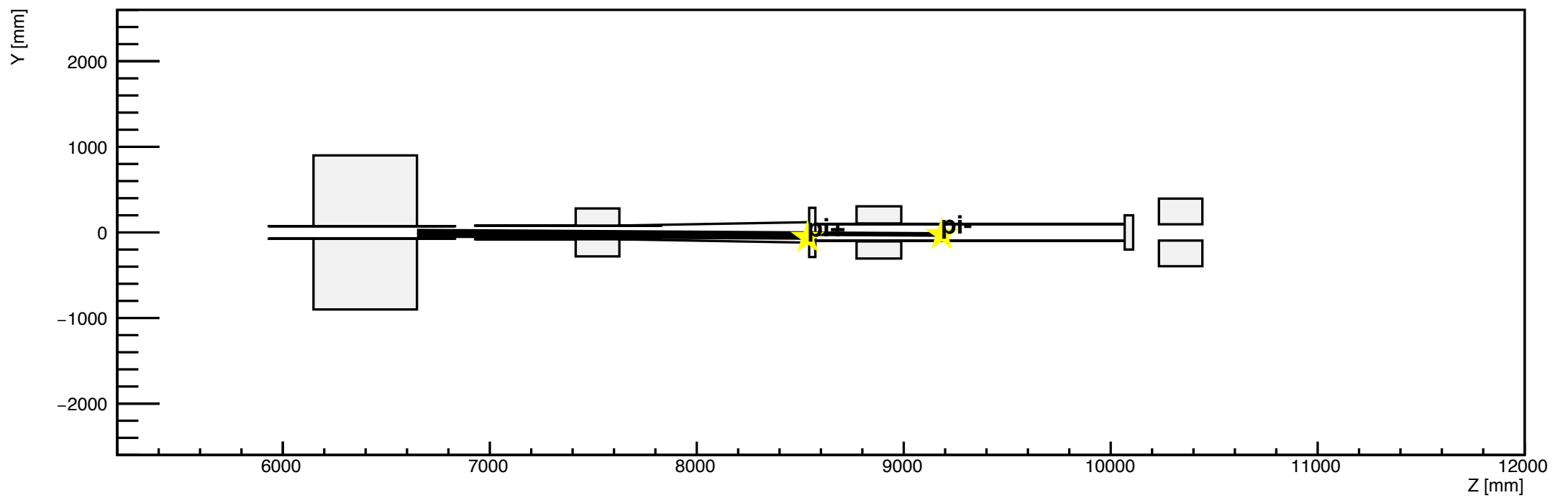

h2

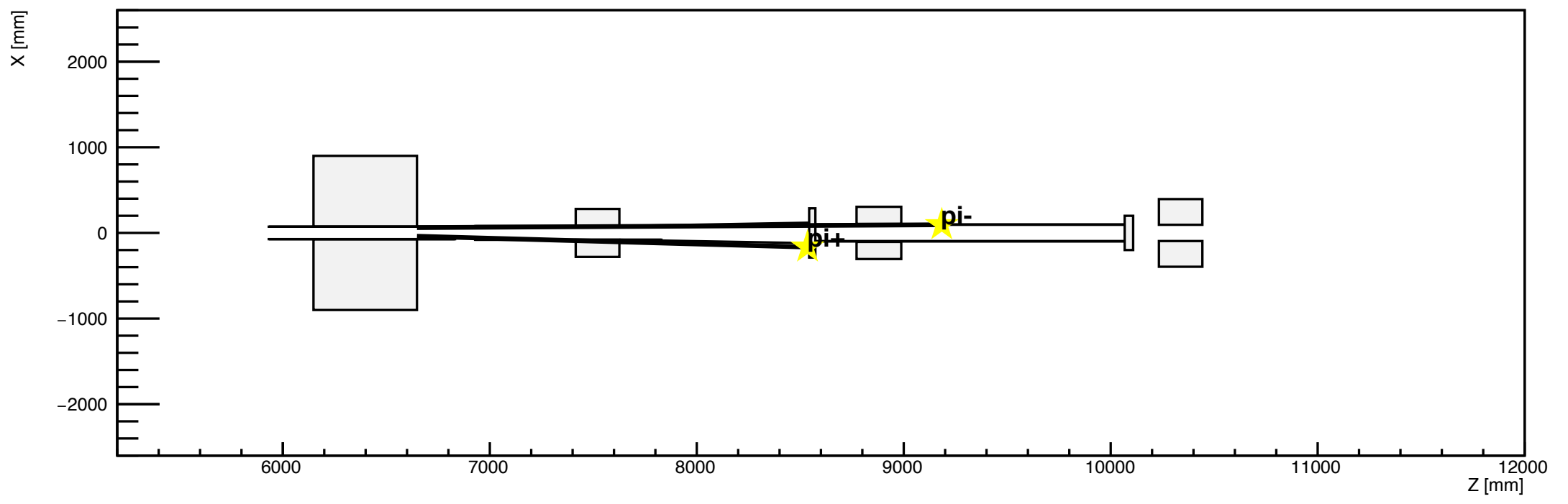

h1

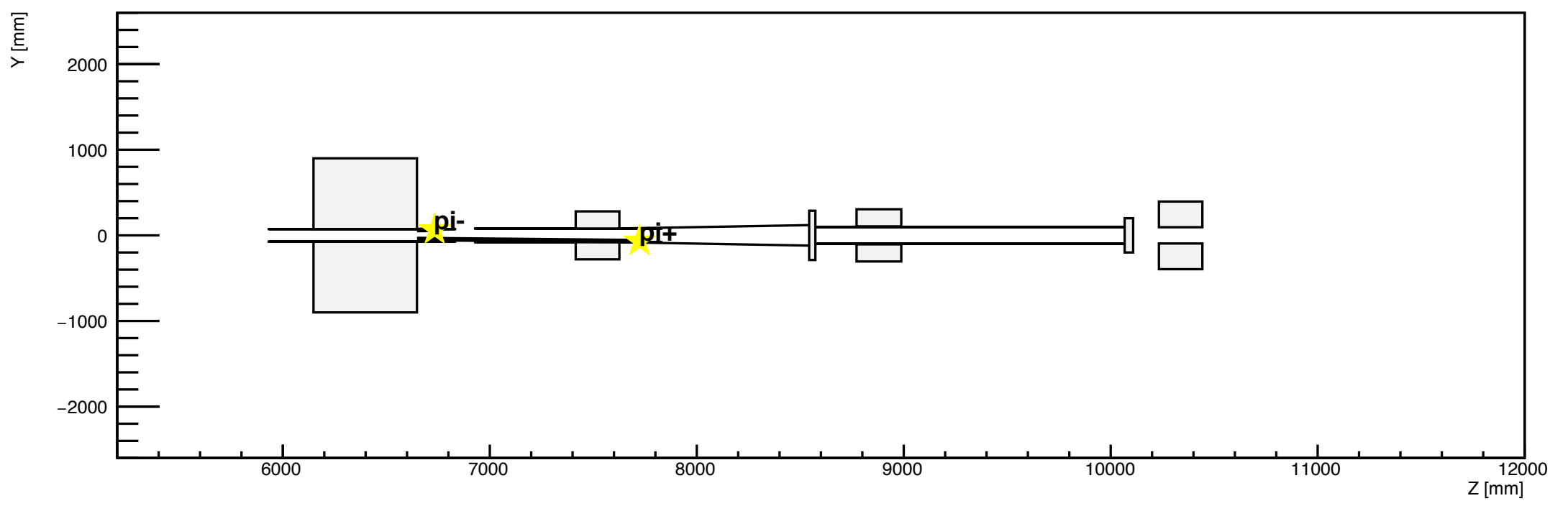

h2

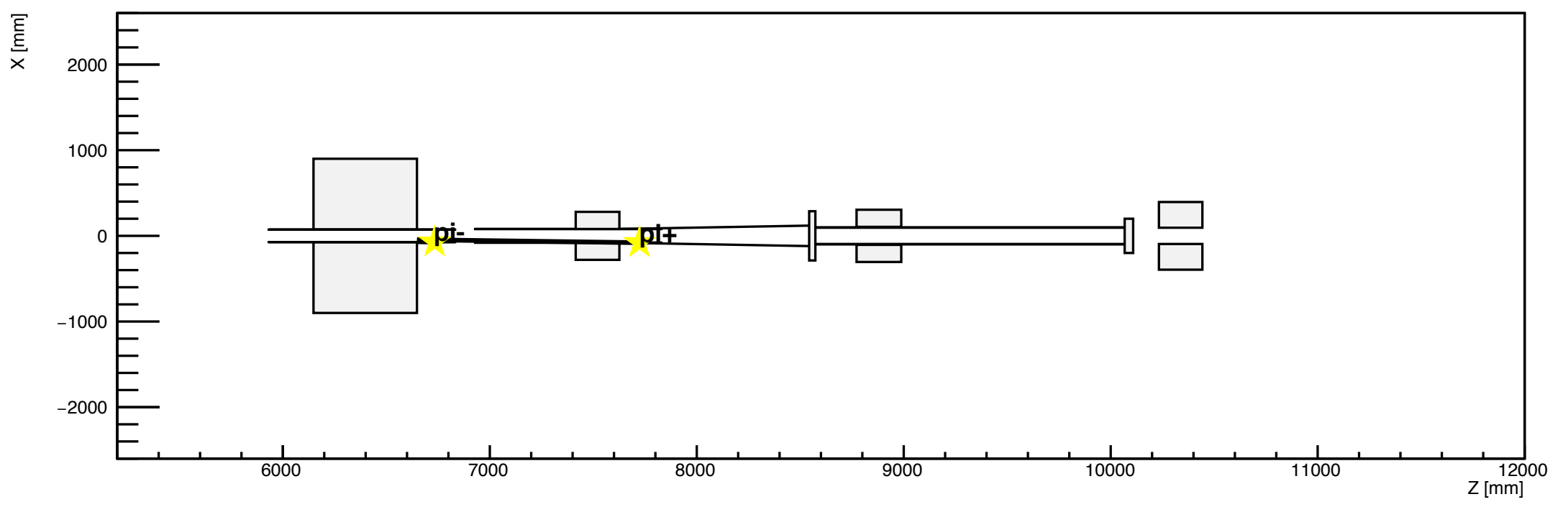

h1

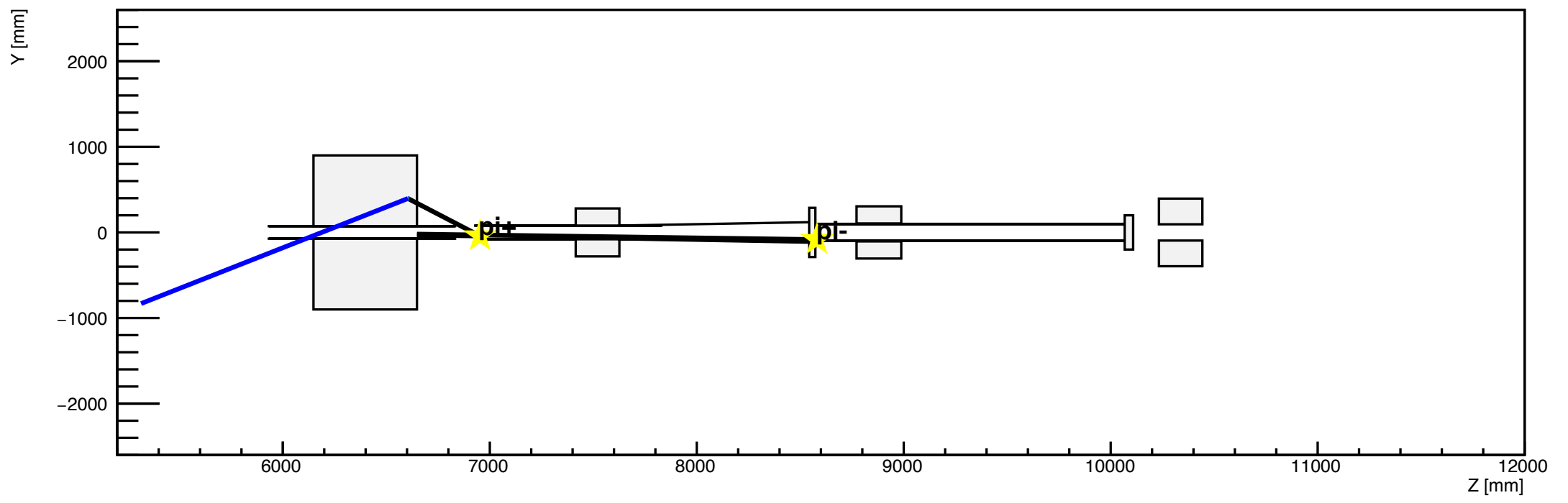

h2

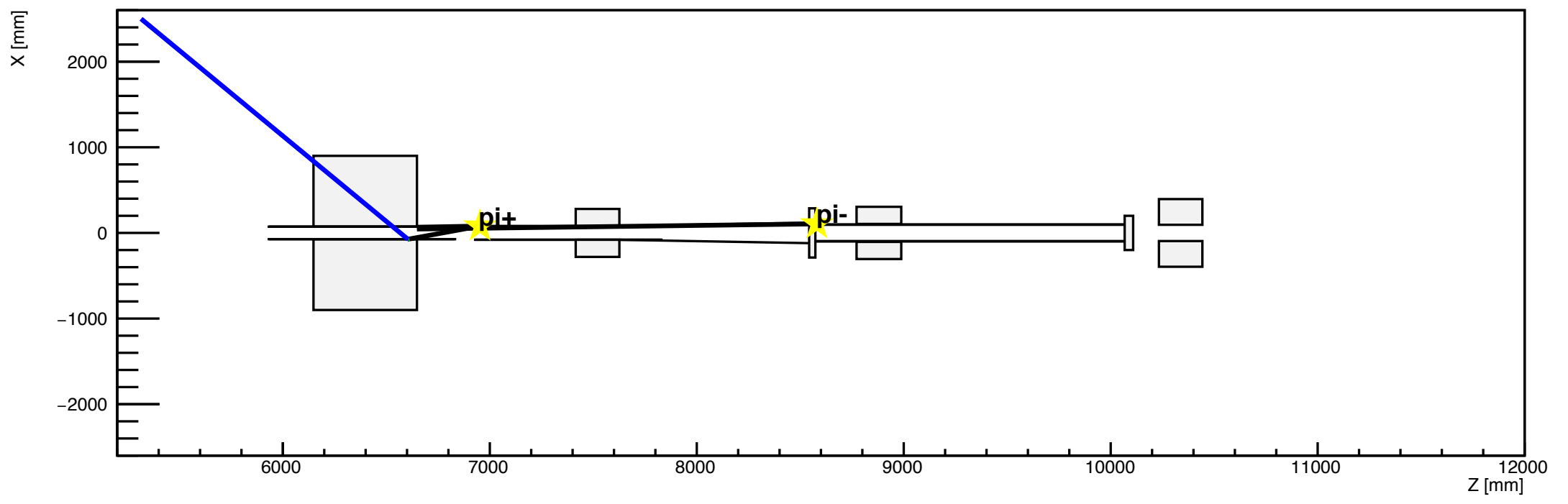

h1

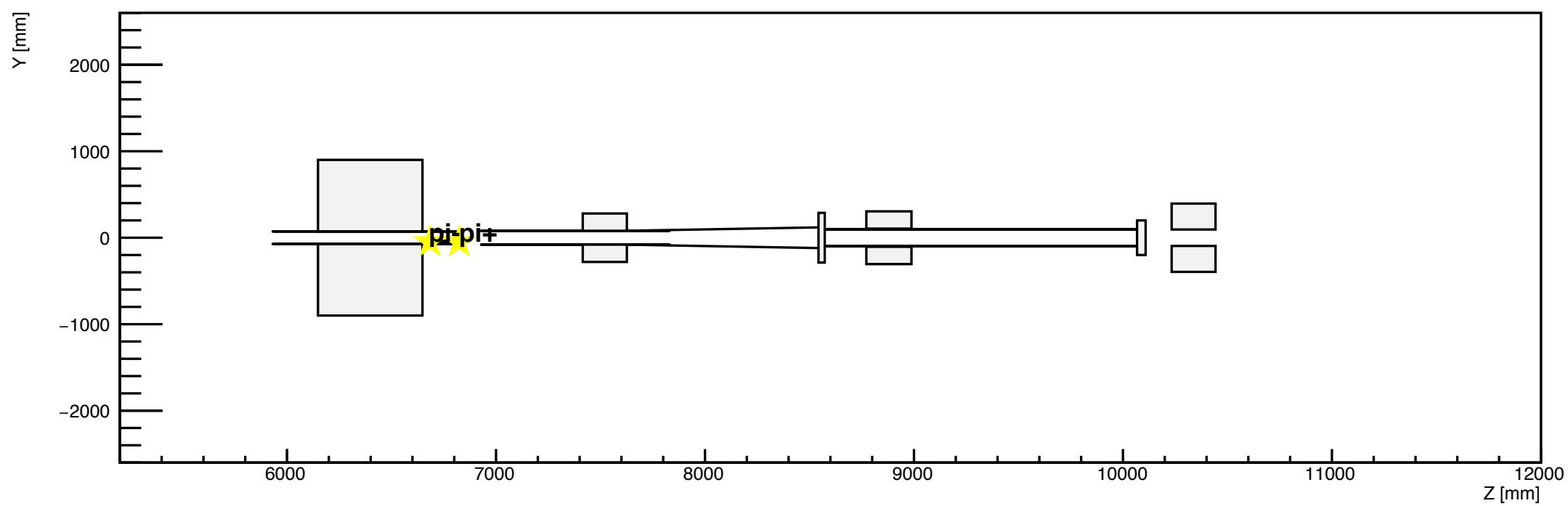

h2

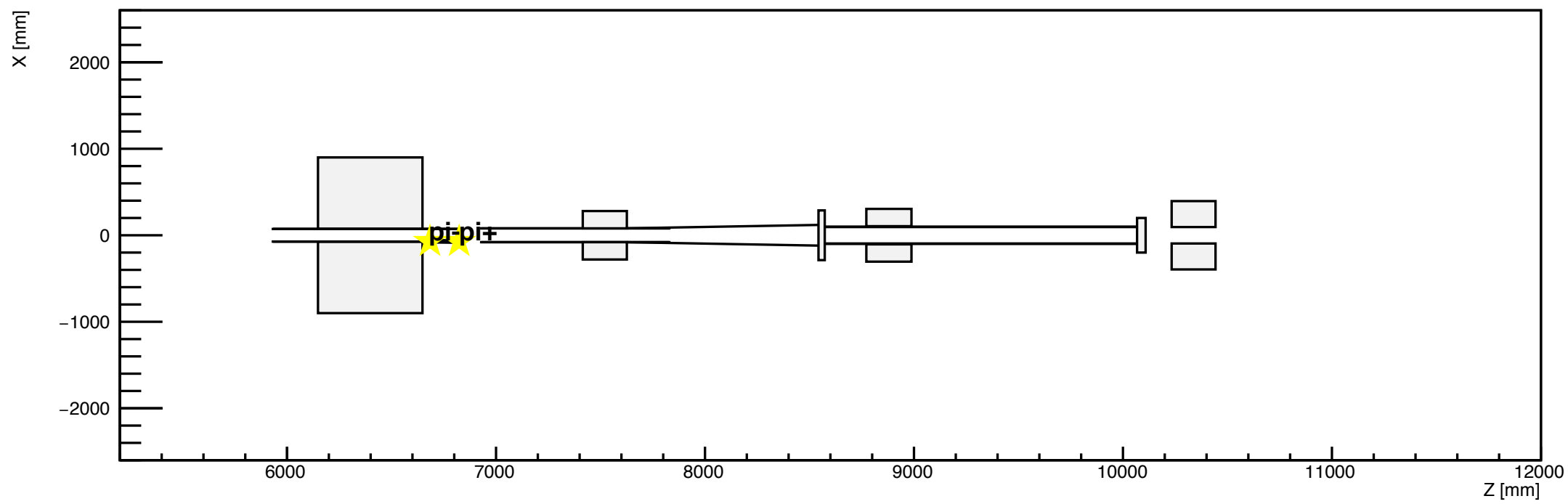

h1

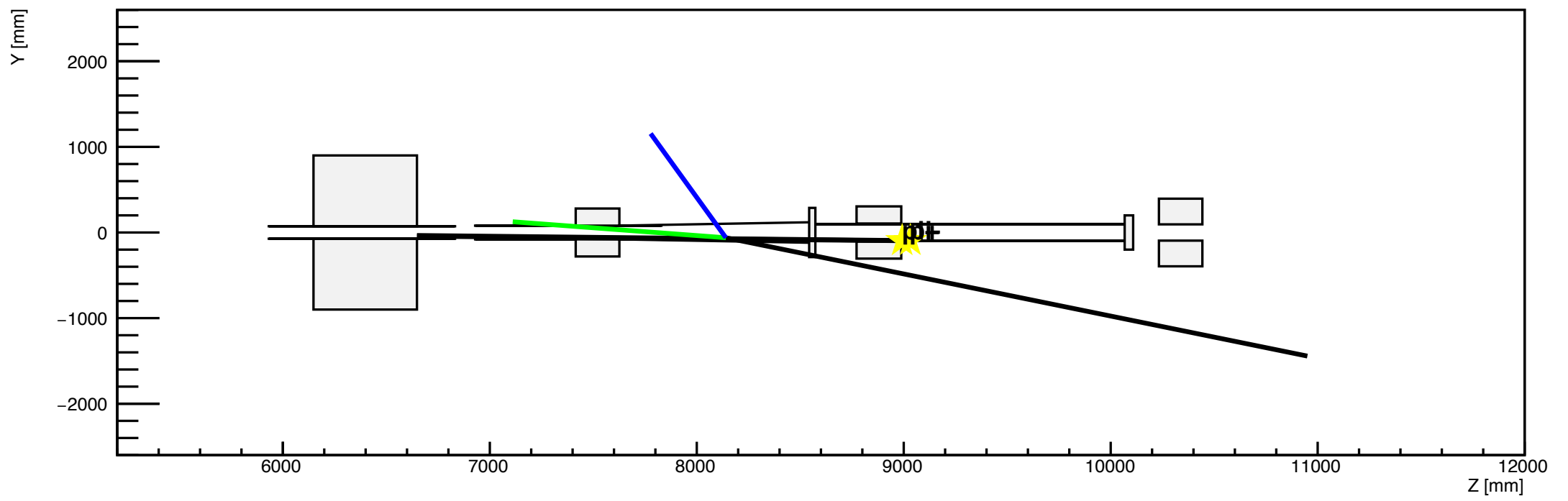

h2

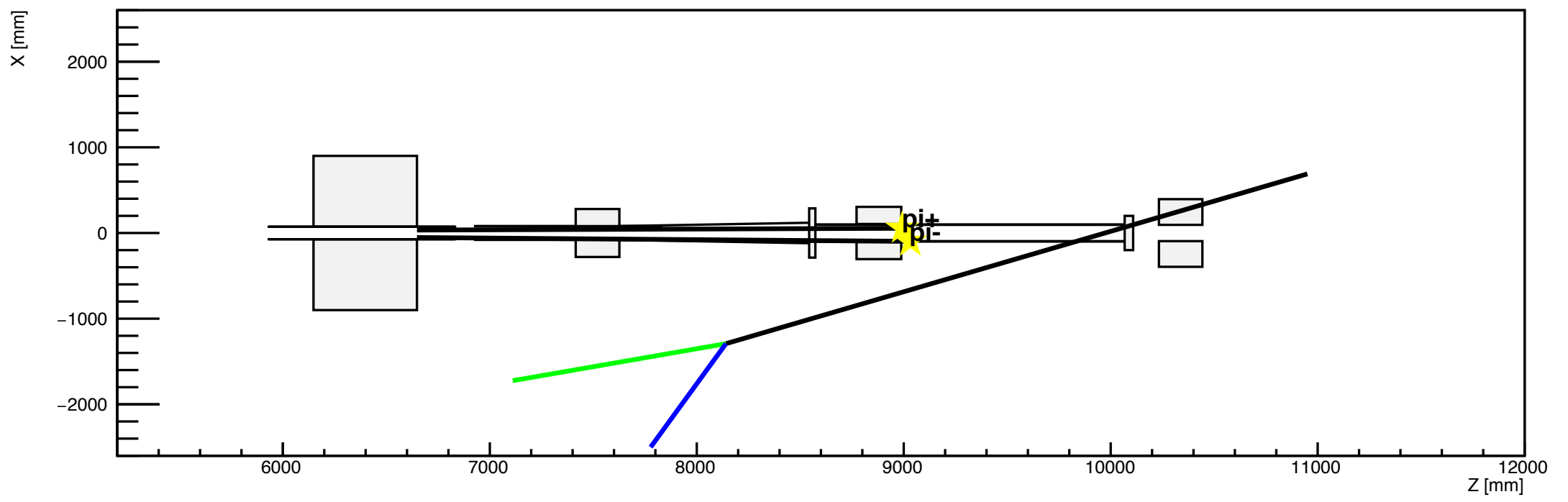

h1

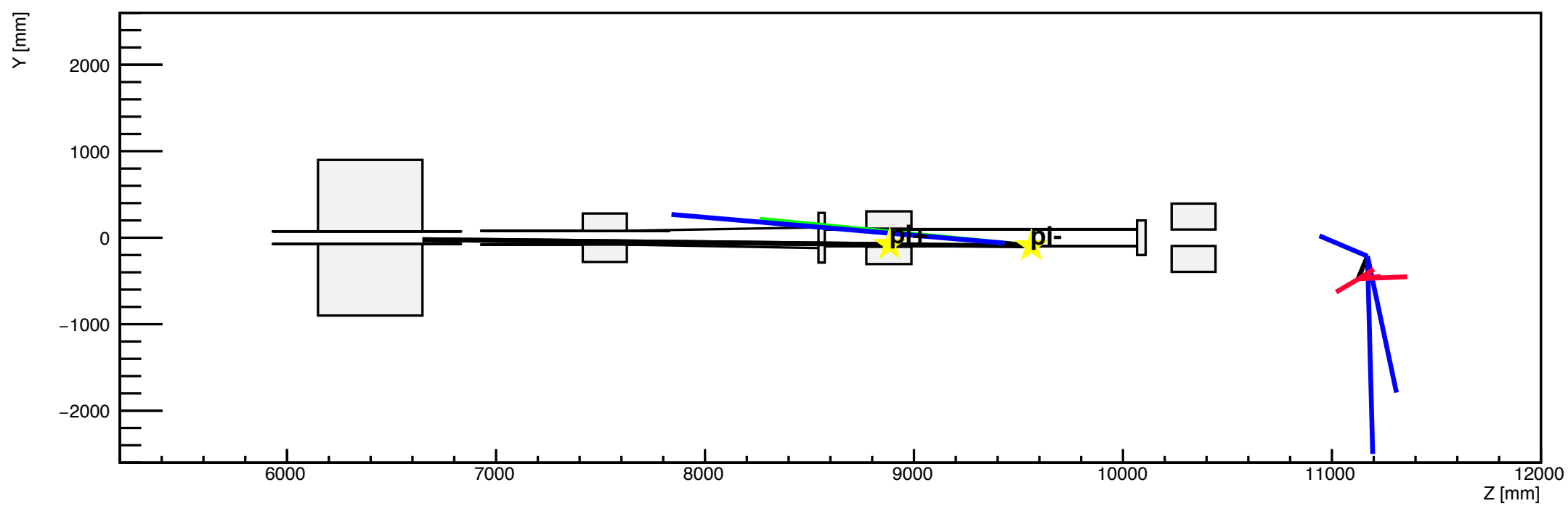

h2

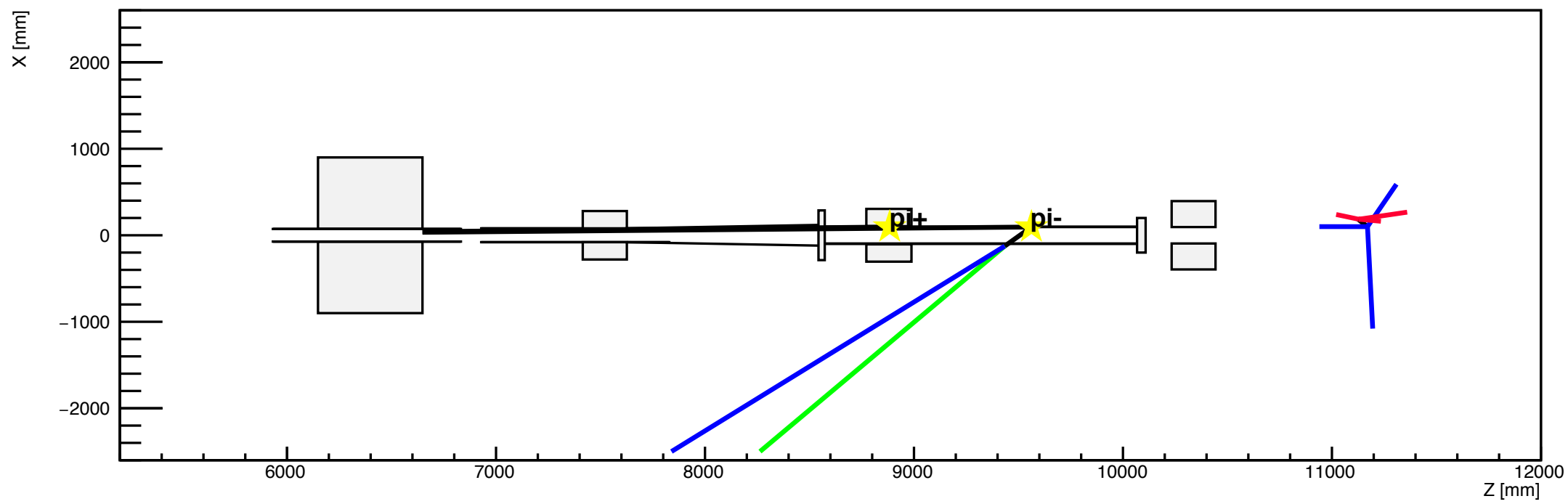

h1

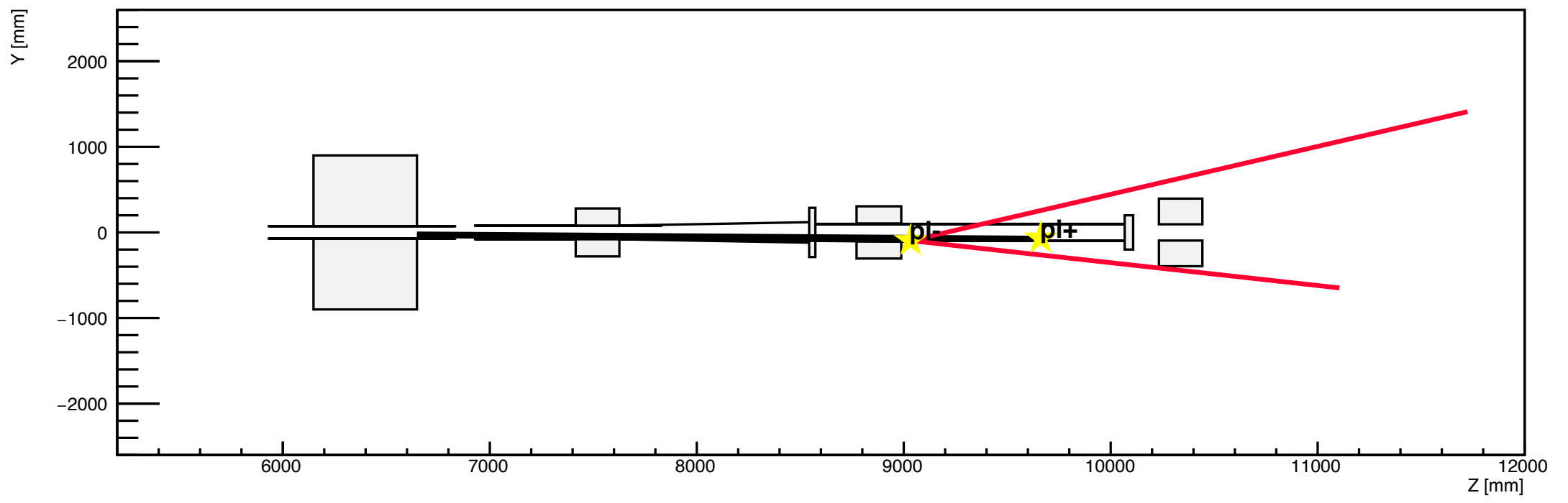

h2

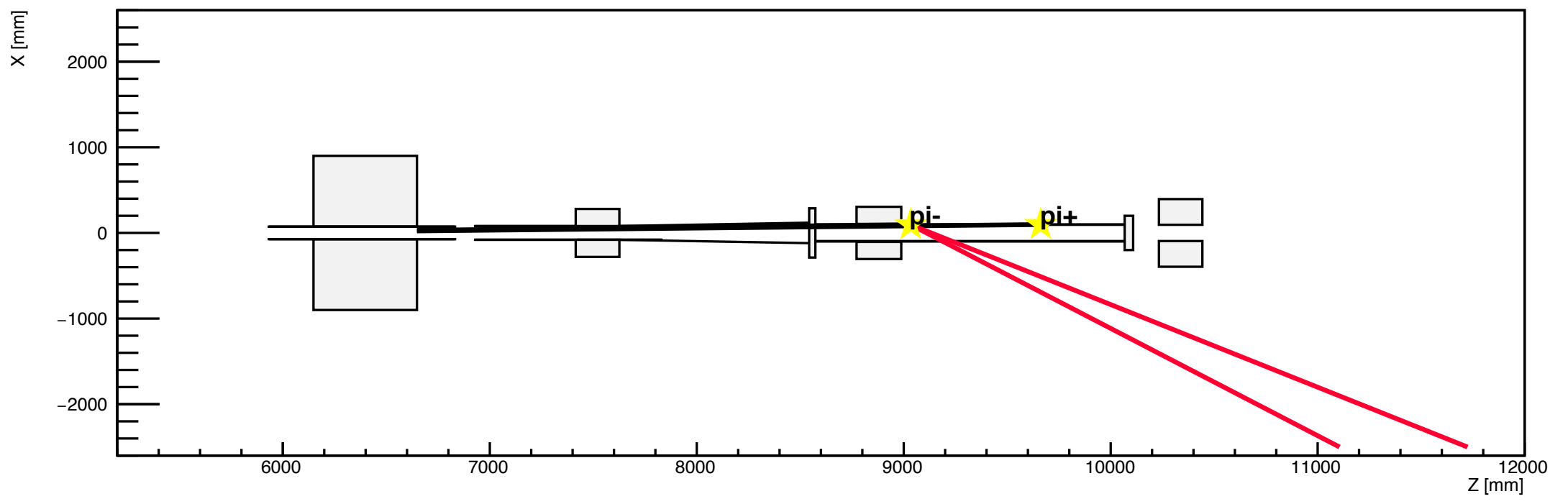

h1

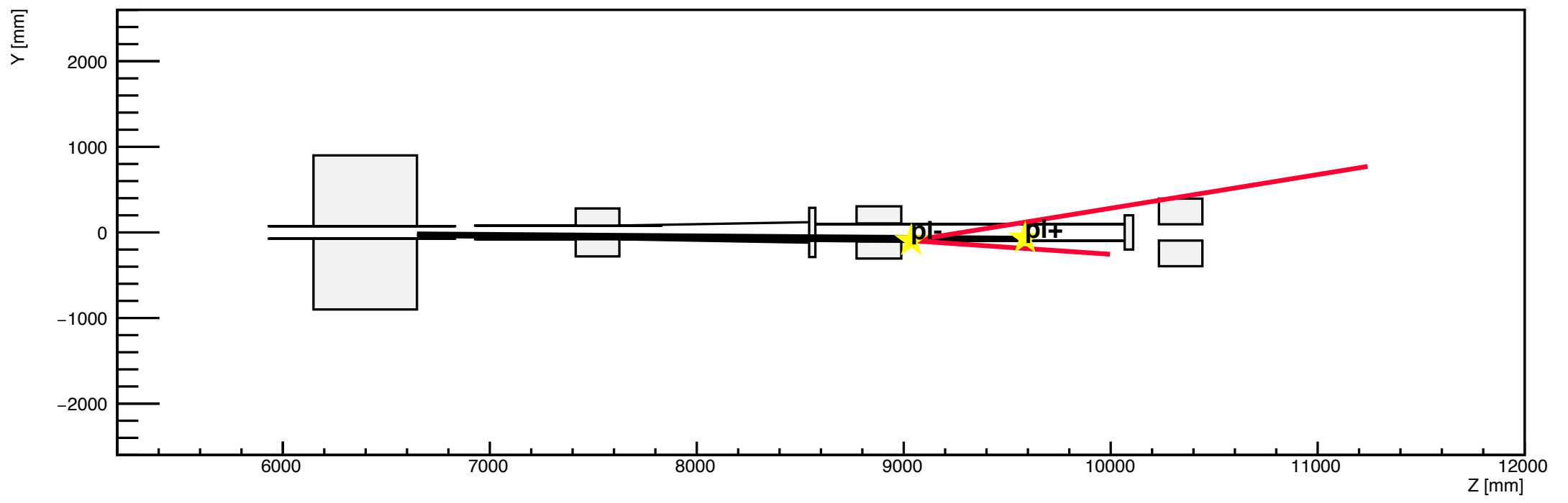

h2

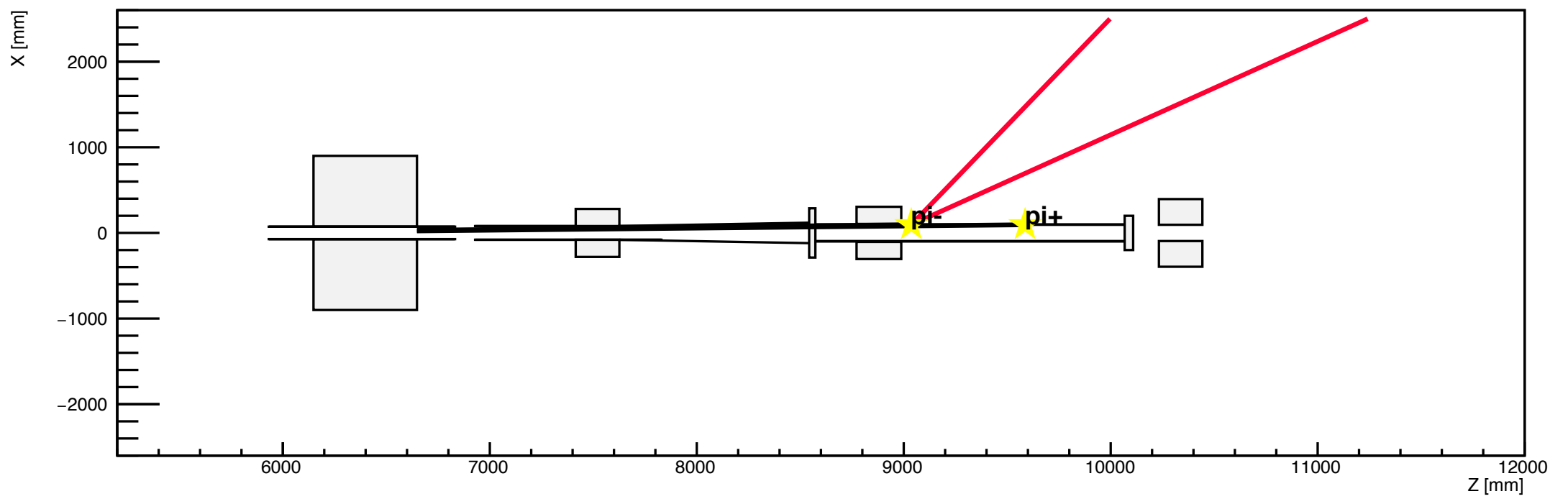

h1

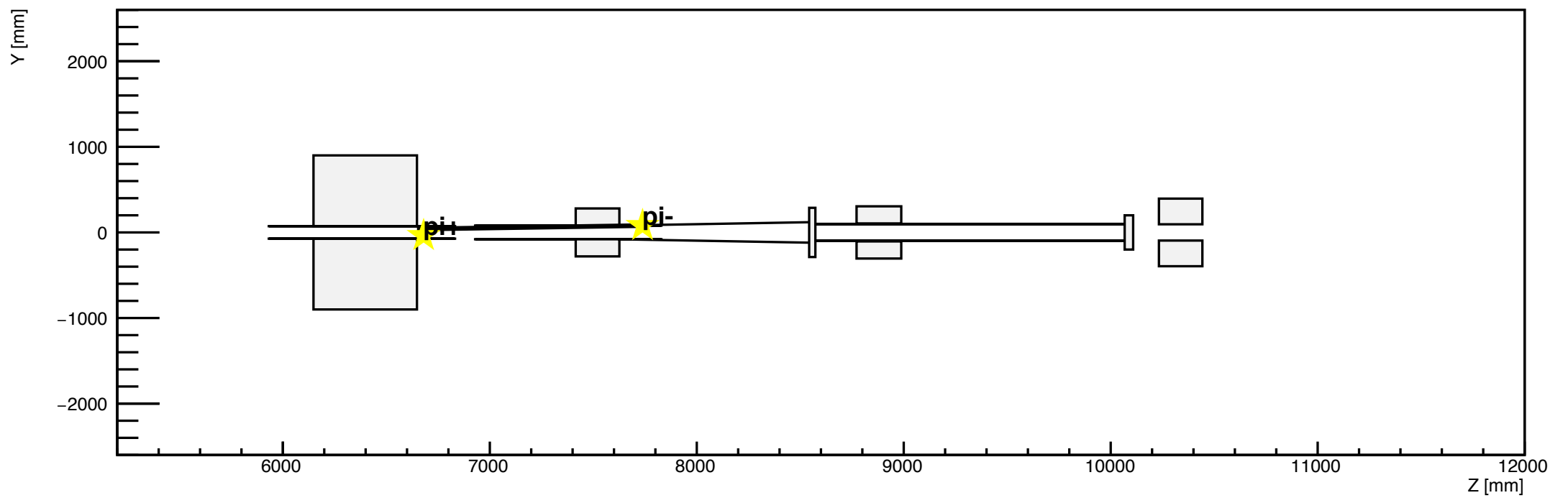

h2

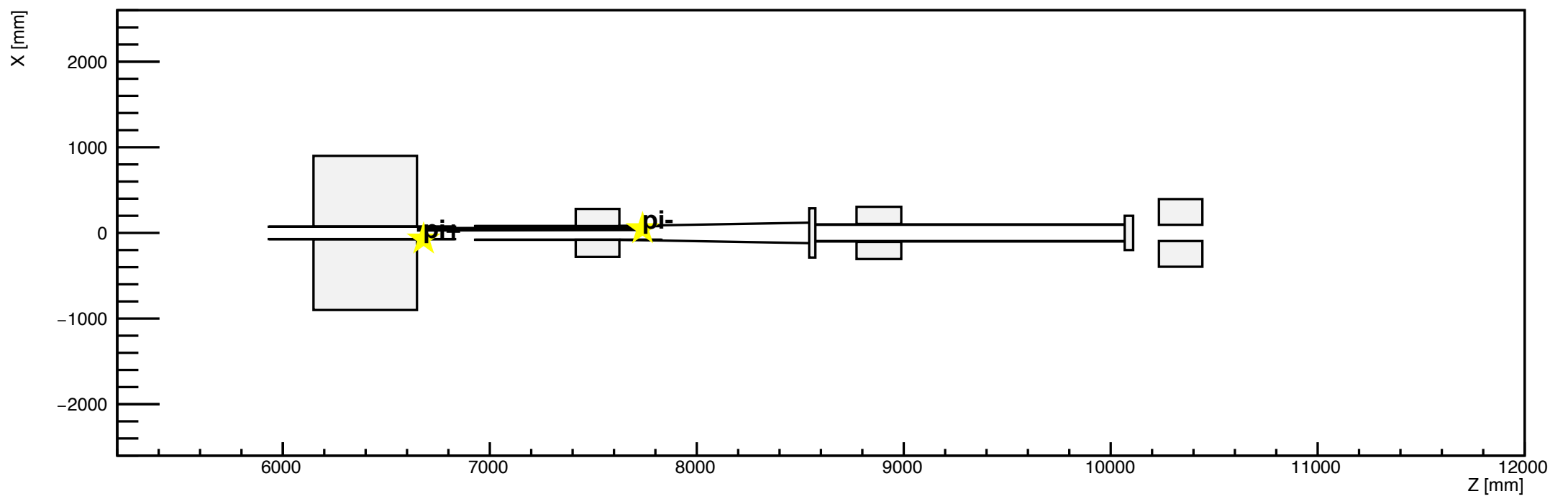

h1

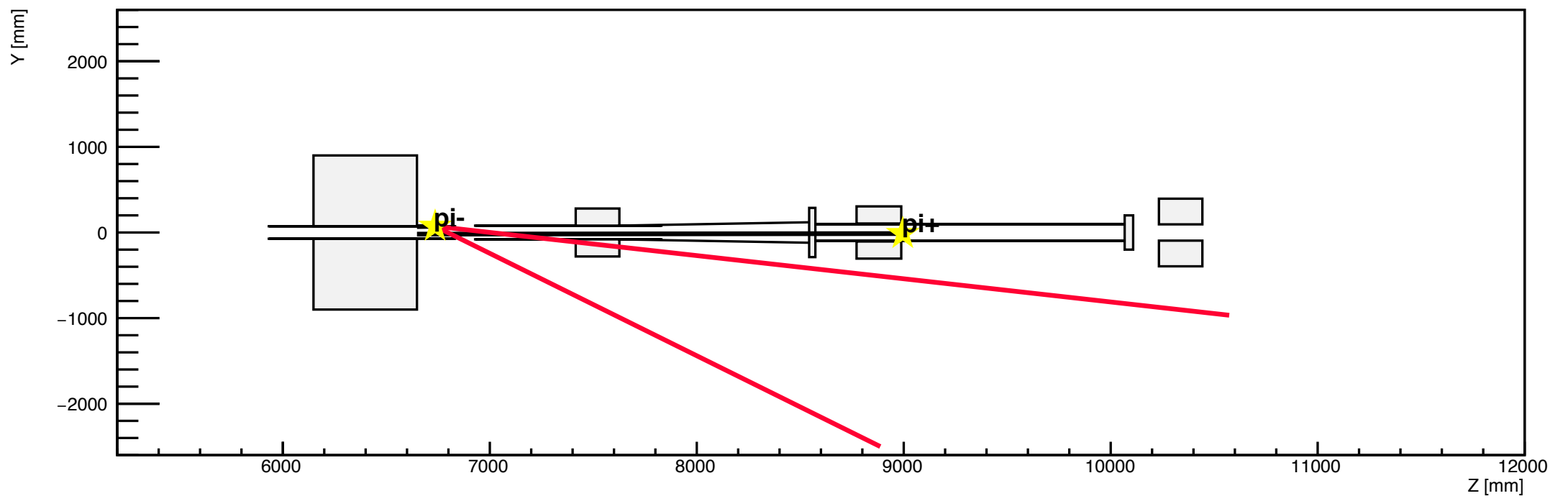

h2

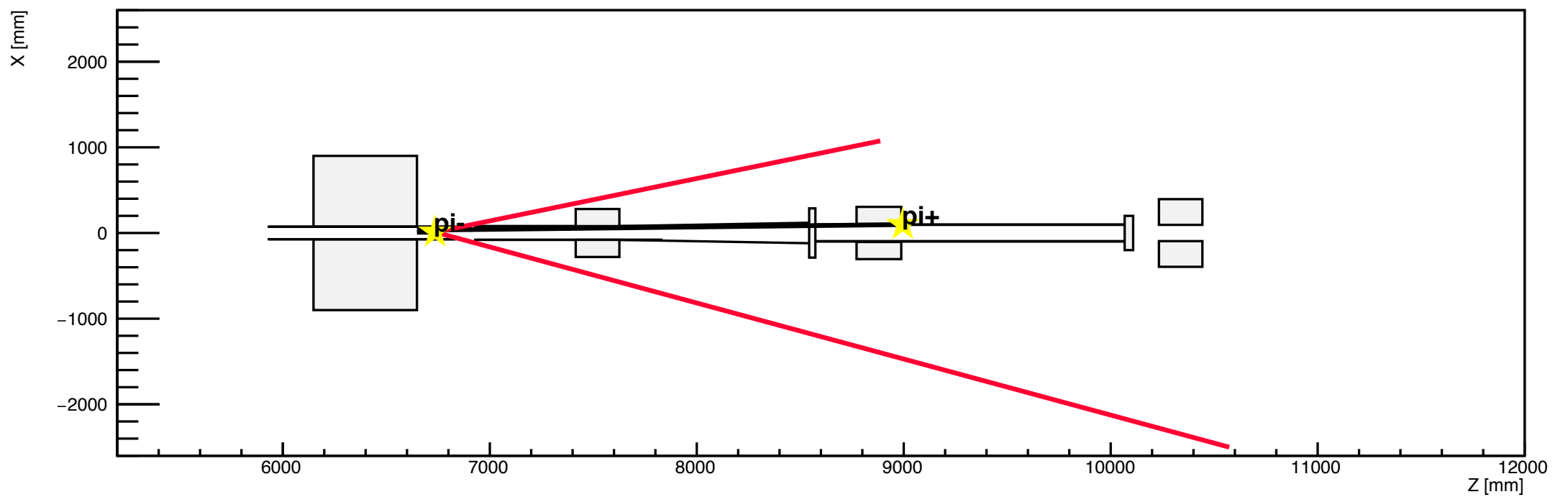

h1

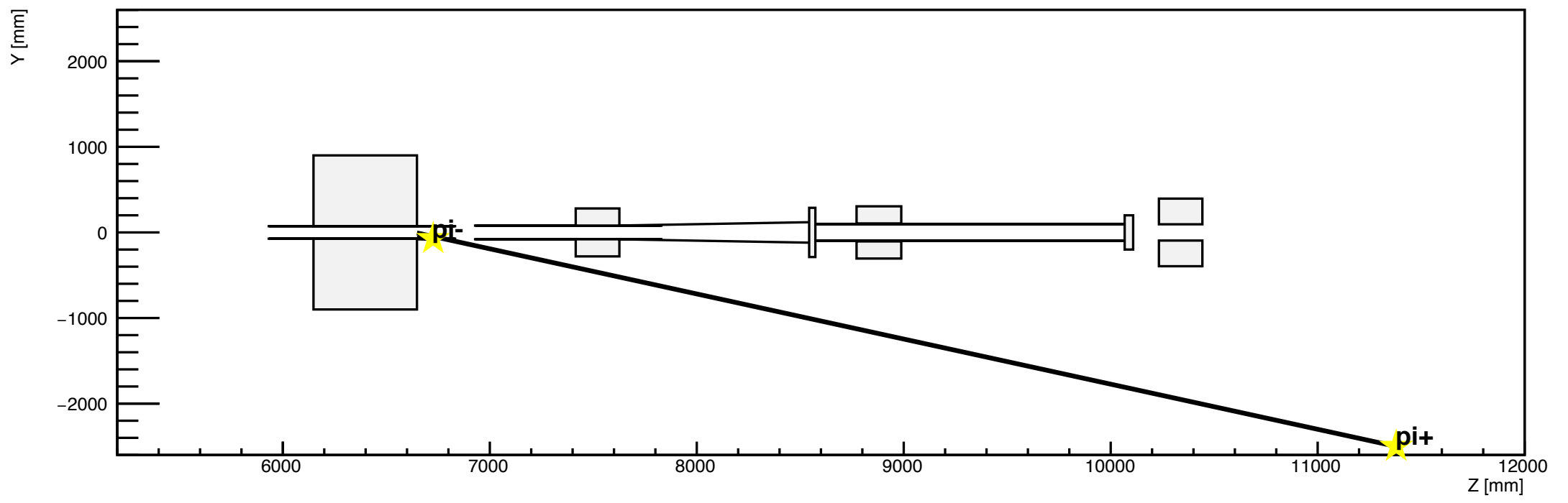

h2

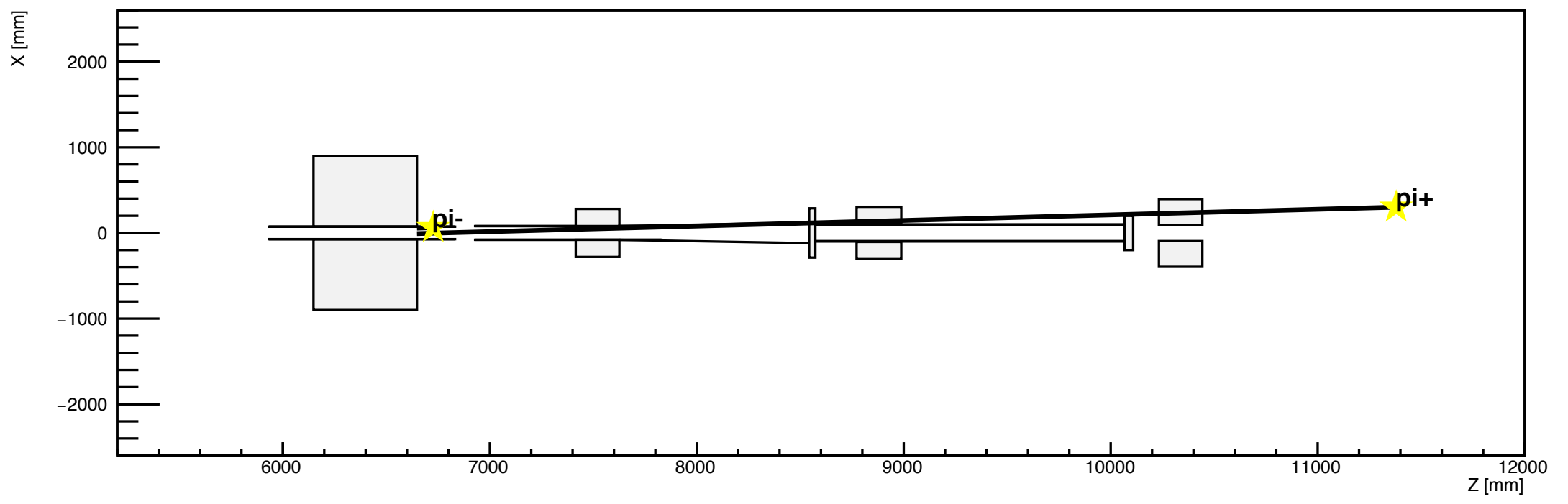

h1

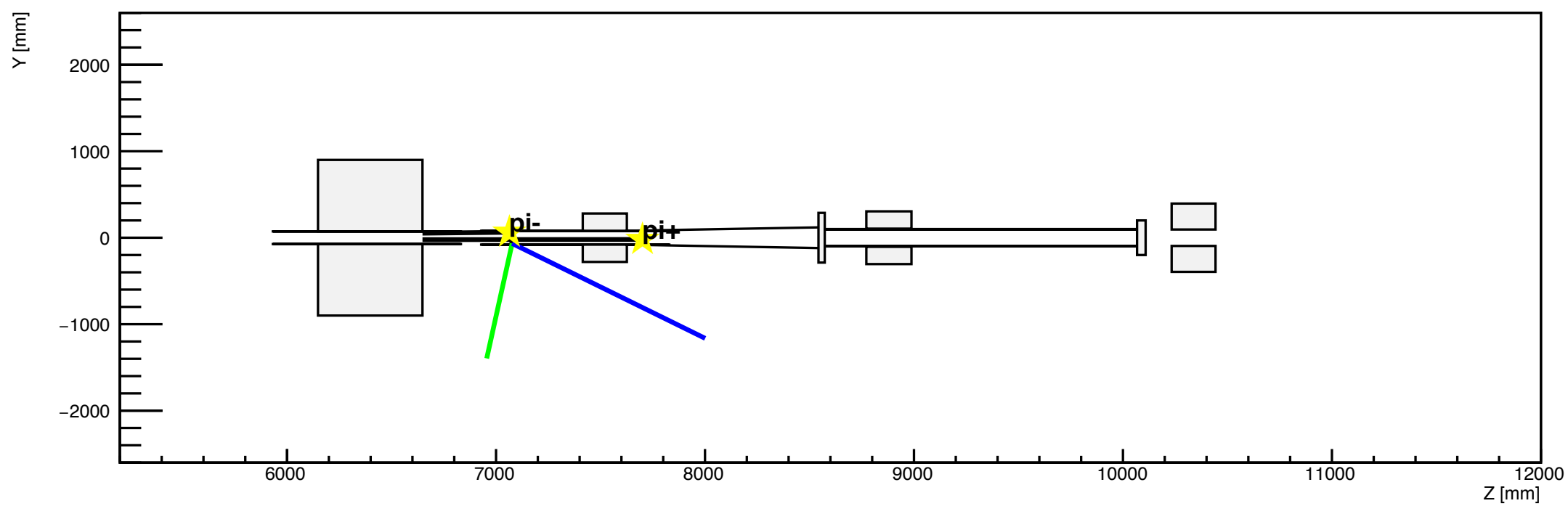

h2

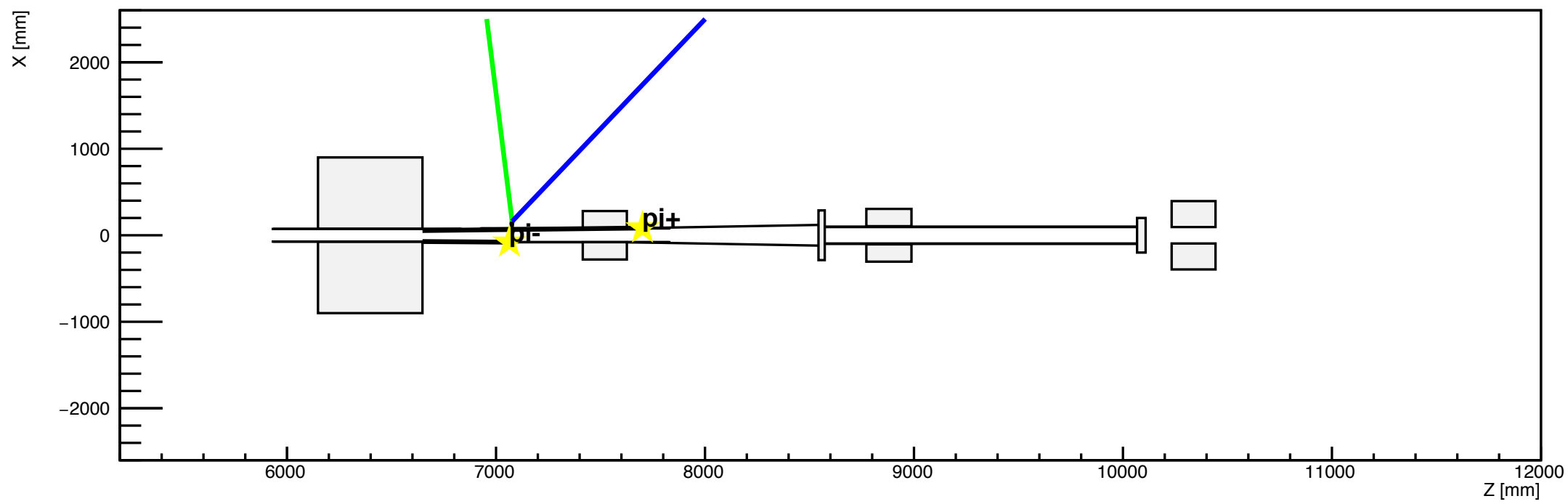

h1

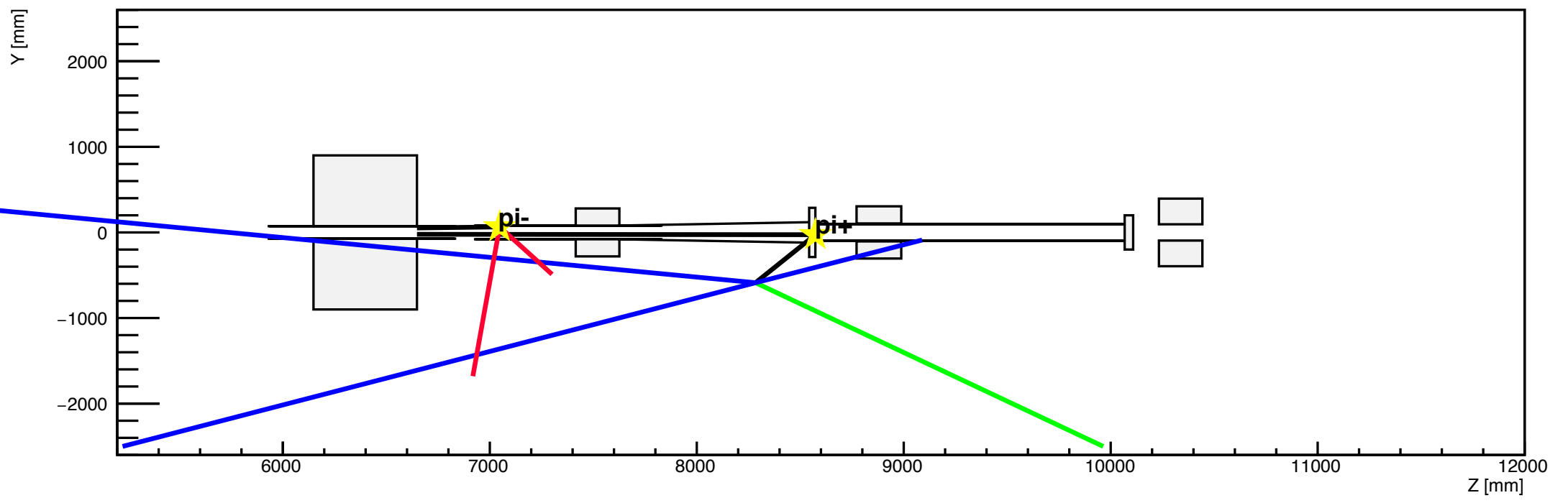

h2

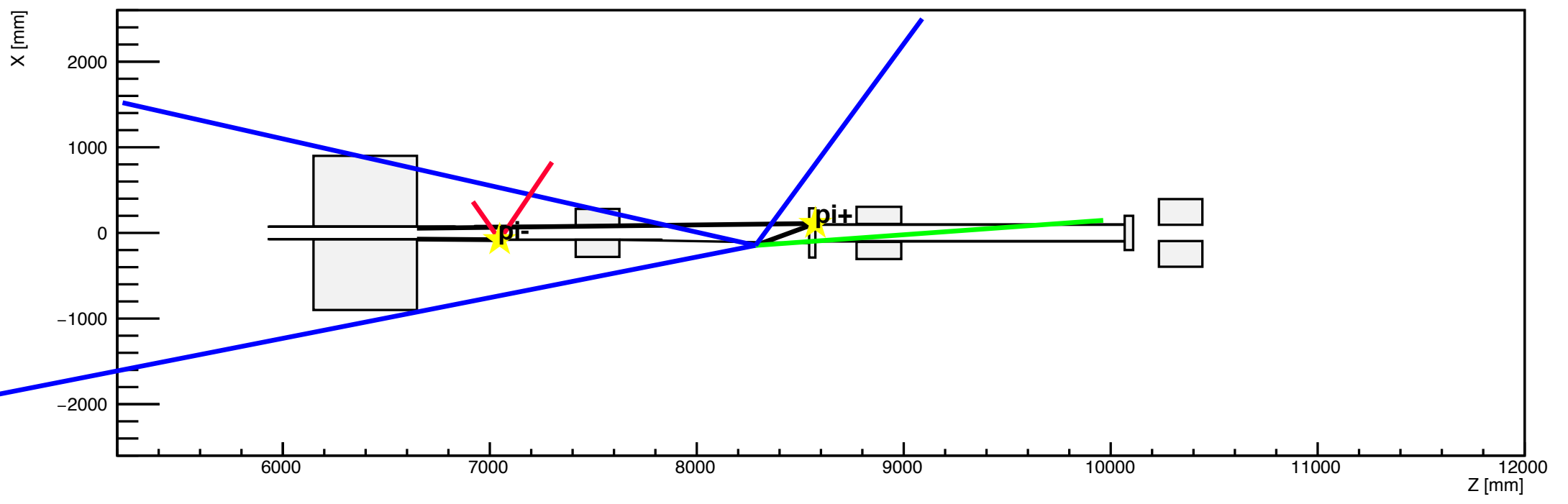

h1

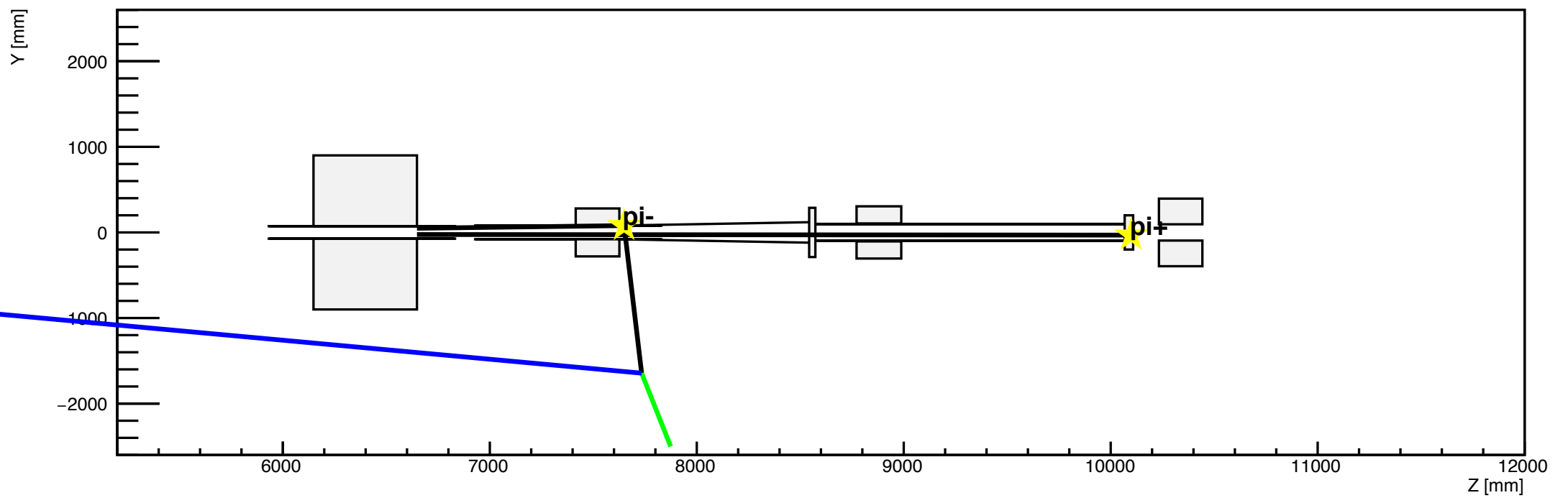

h2

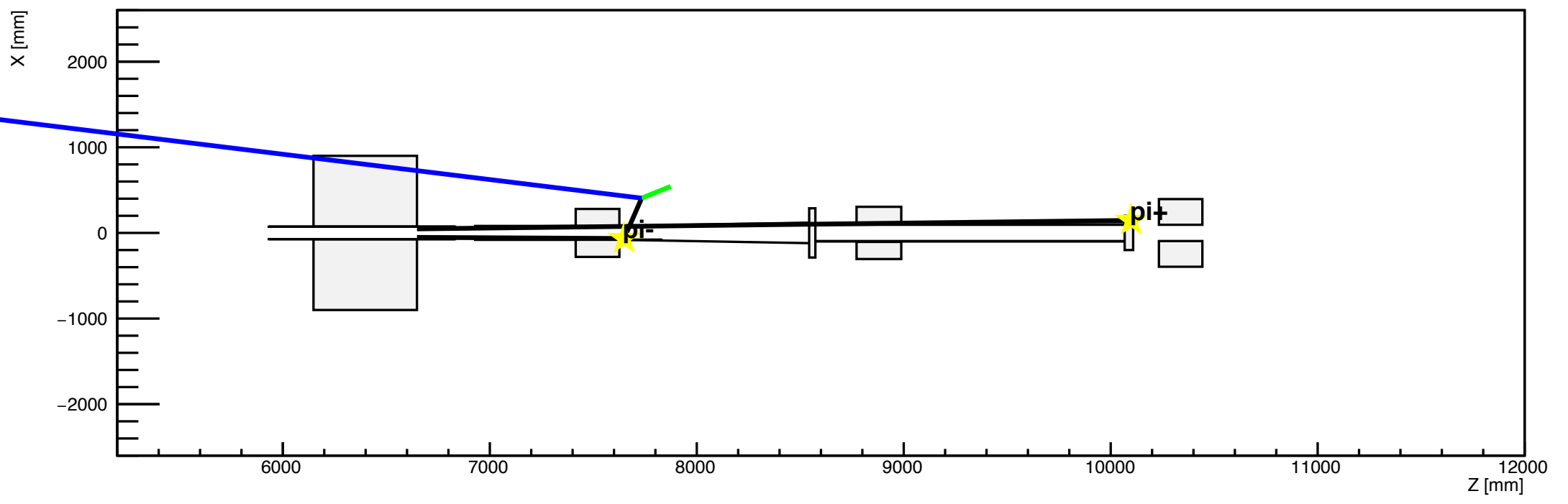

h1

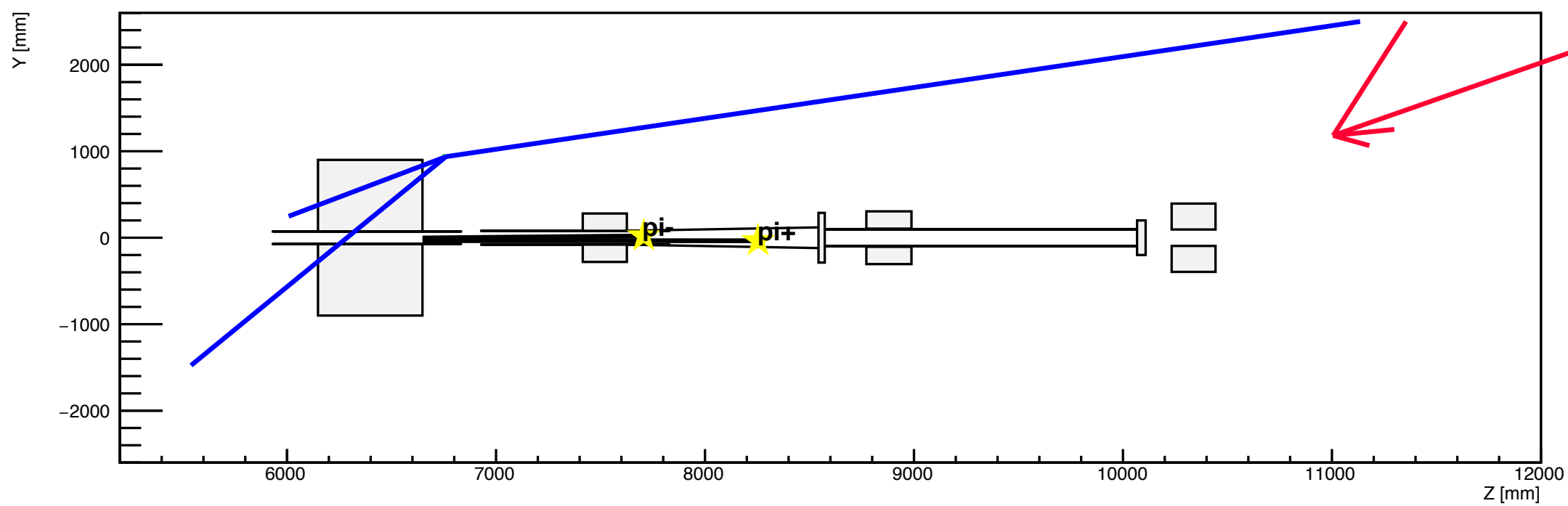

h2

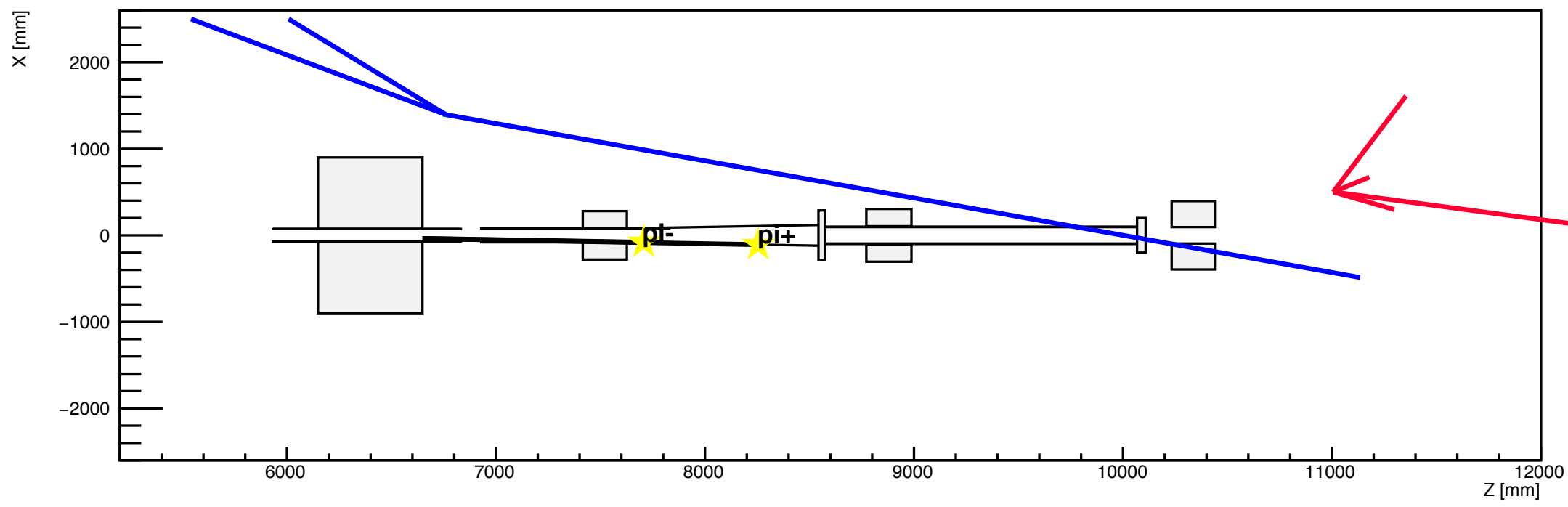

h1

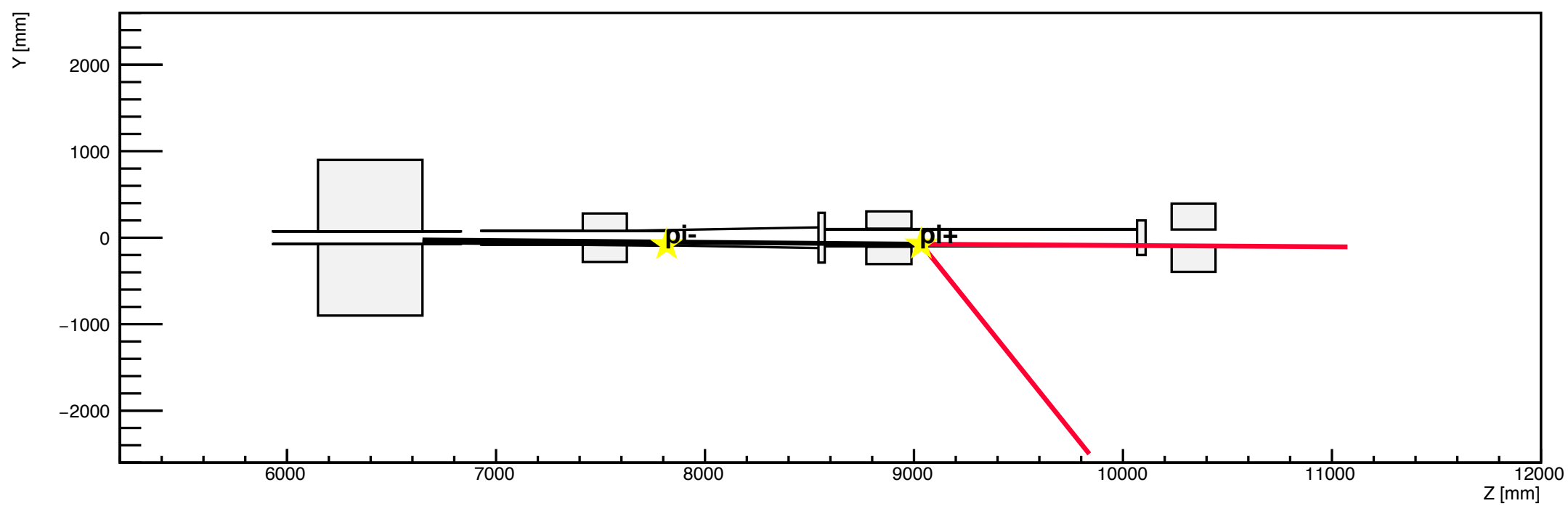

h2

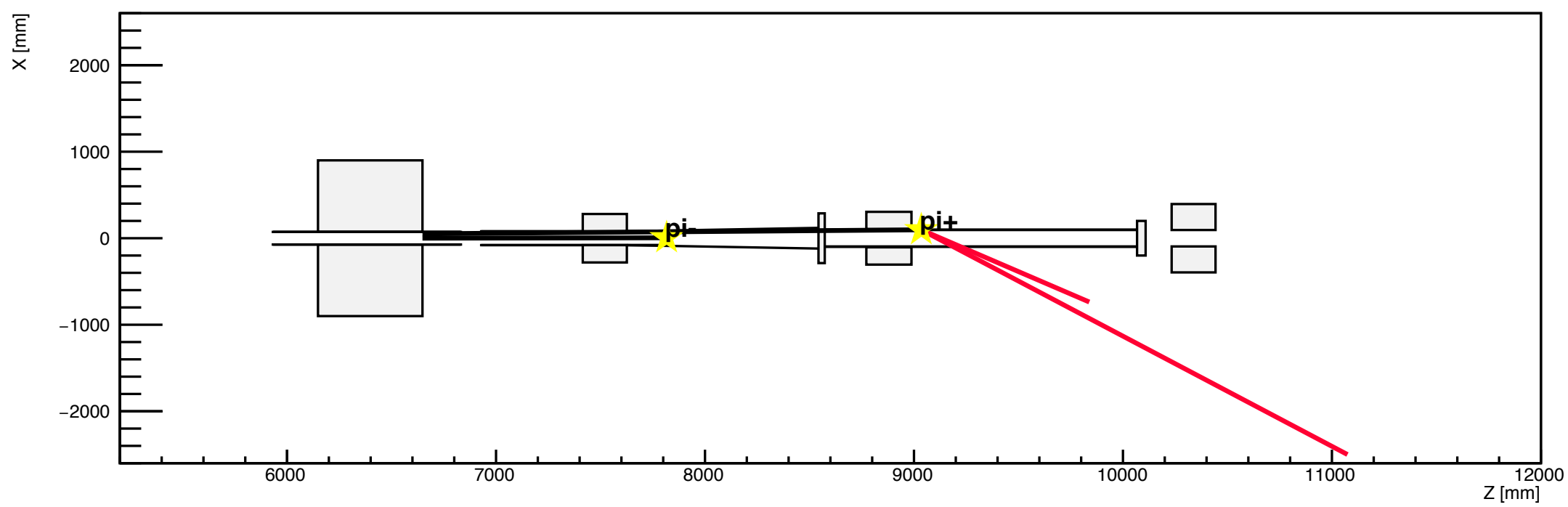

h1

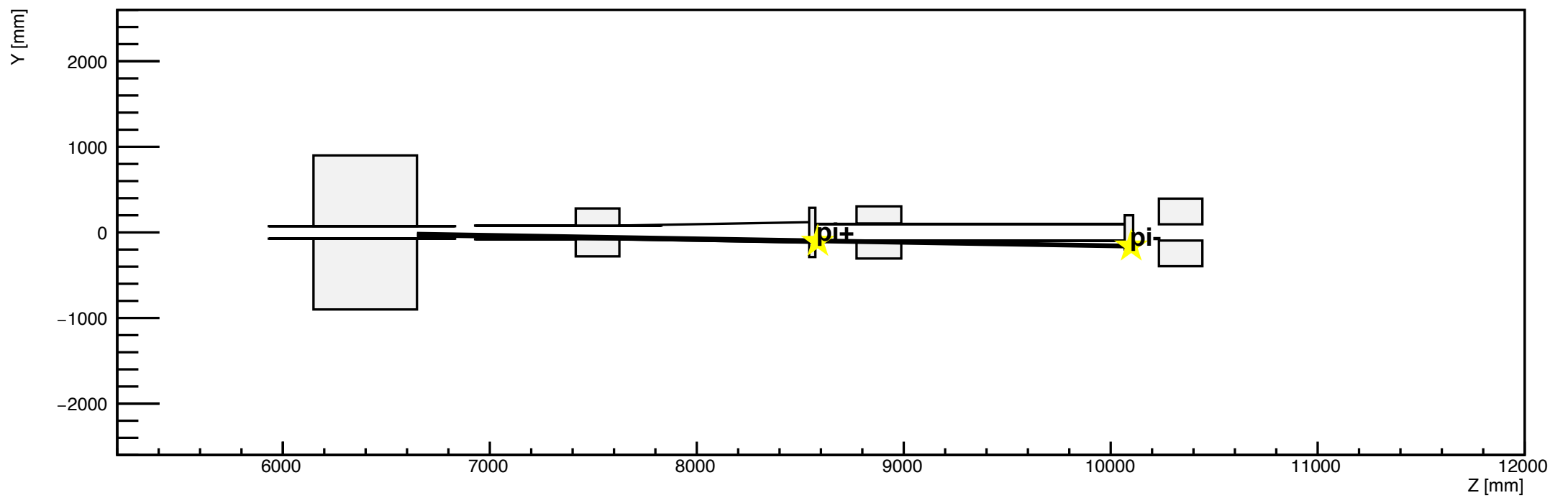

h2

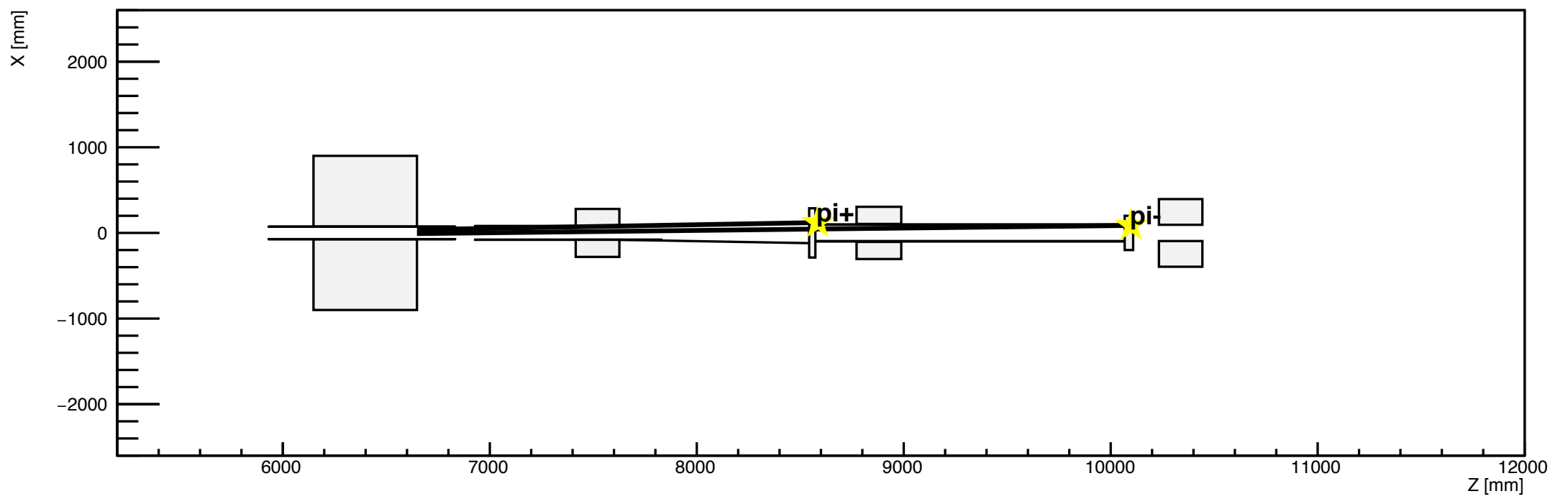

h1

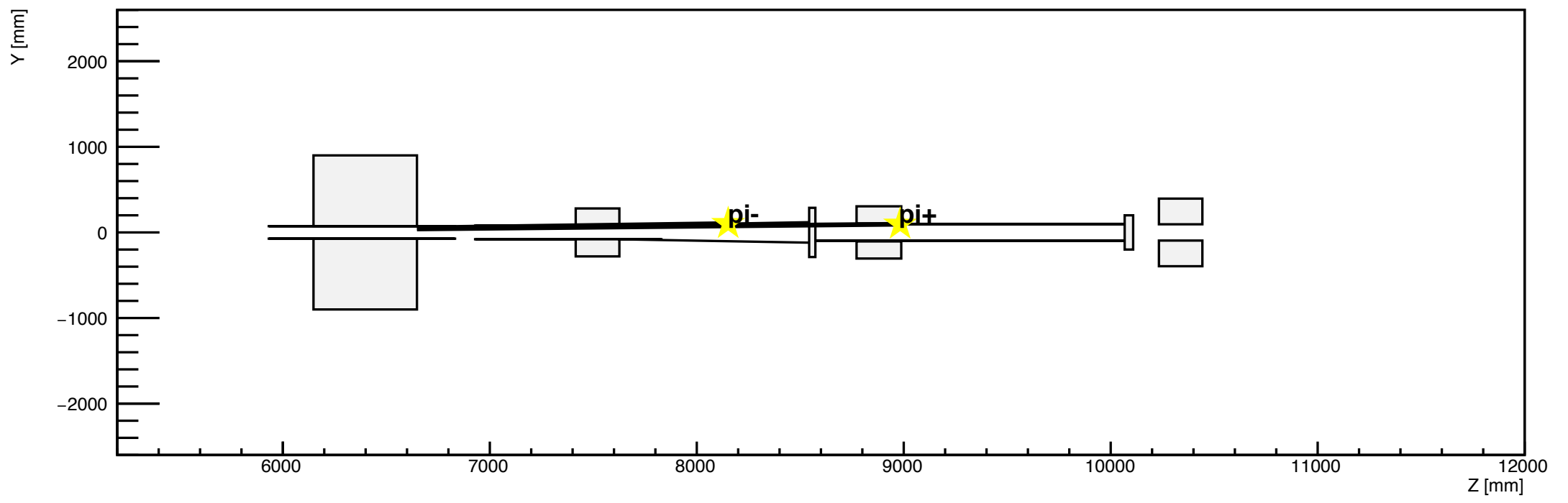

h2

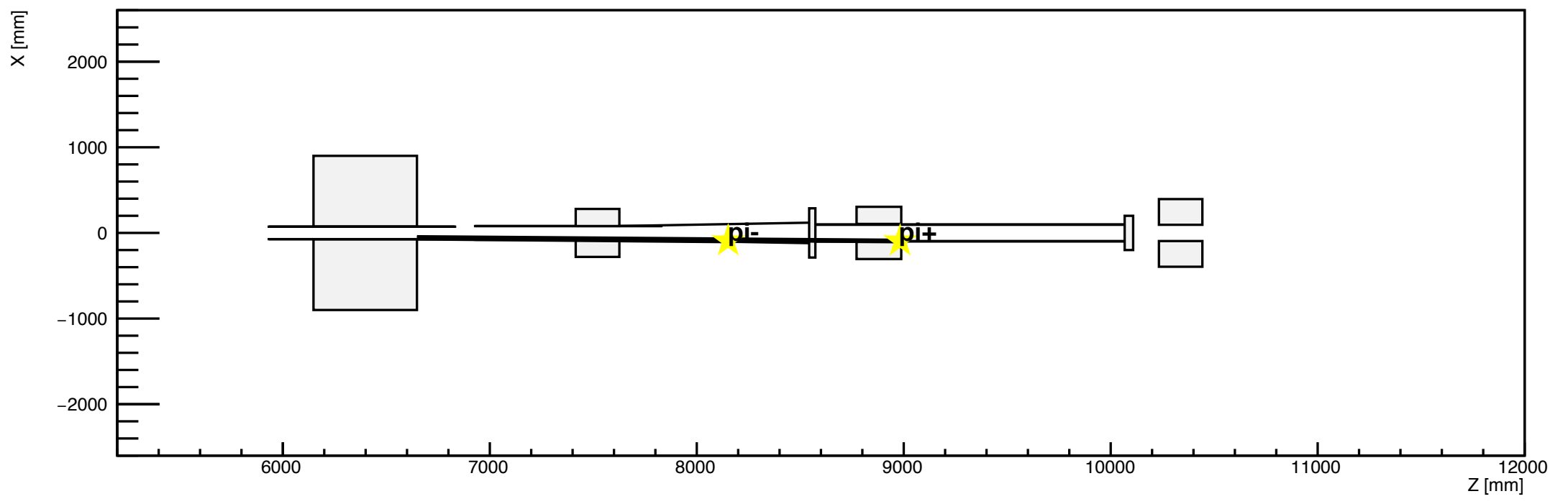

h1

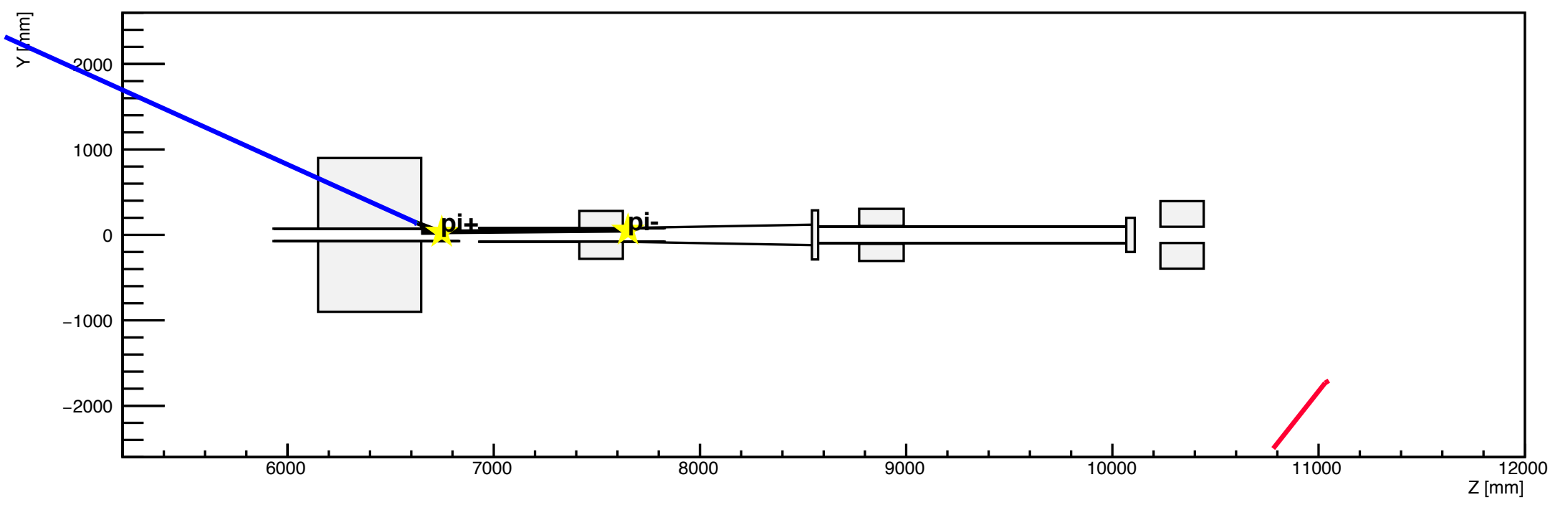

h2

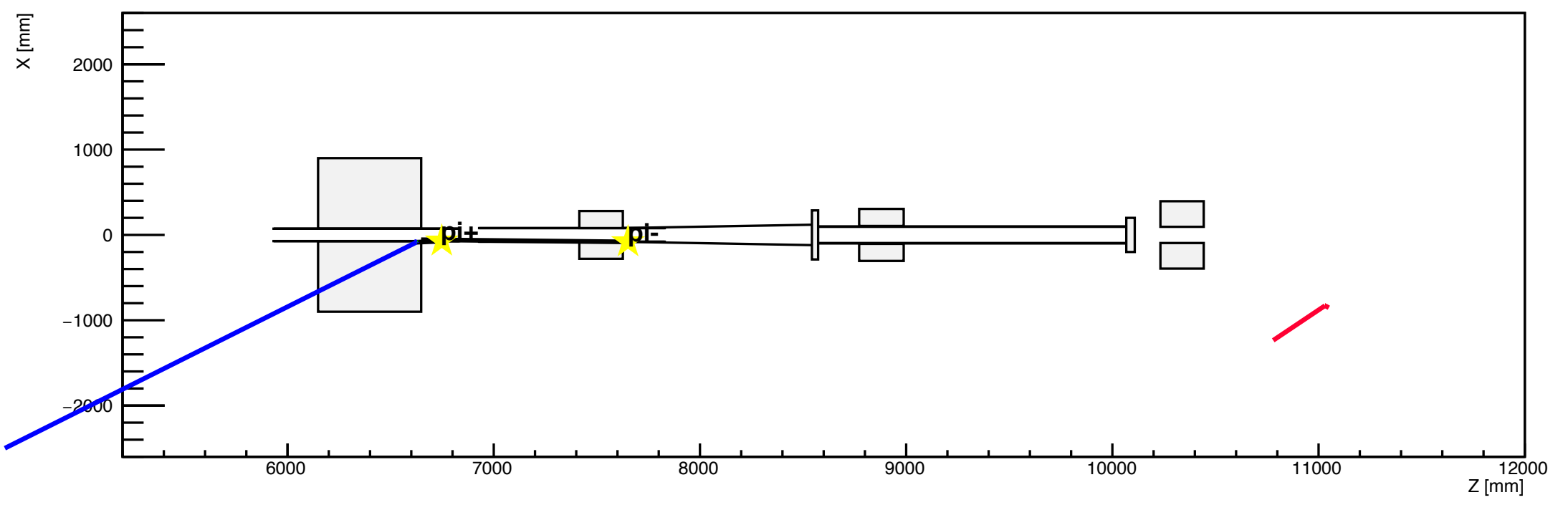

h1

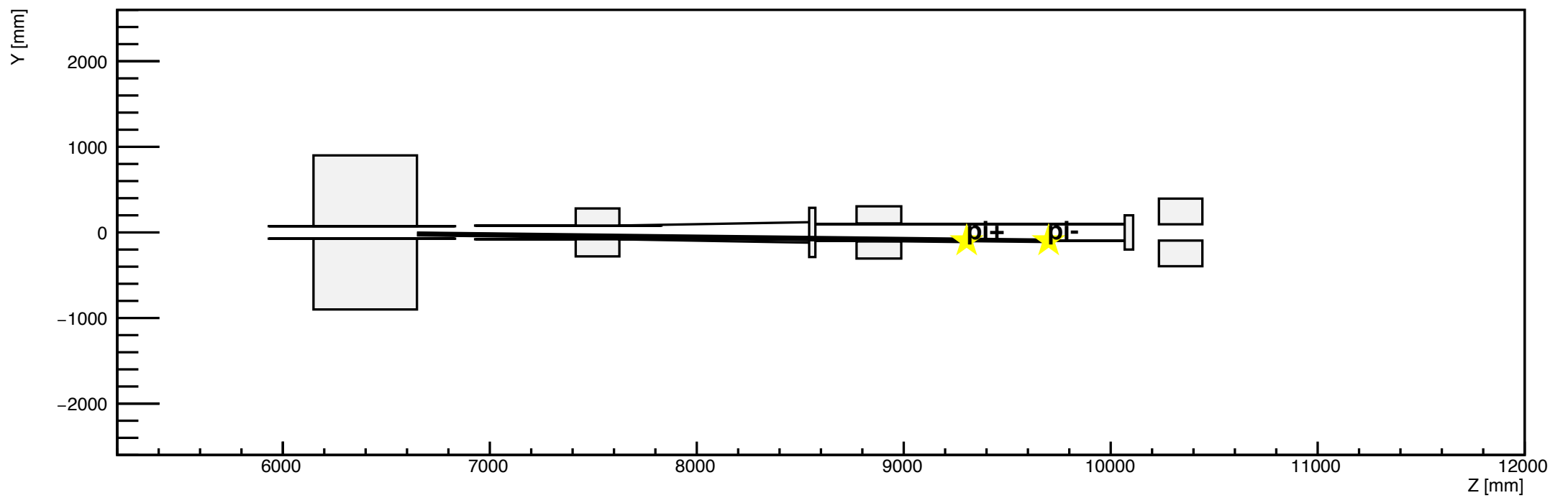

h2

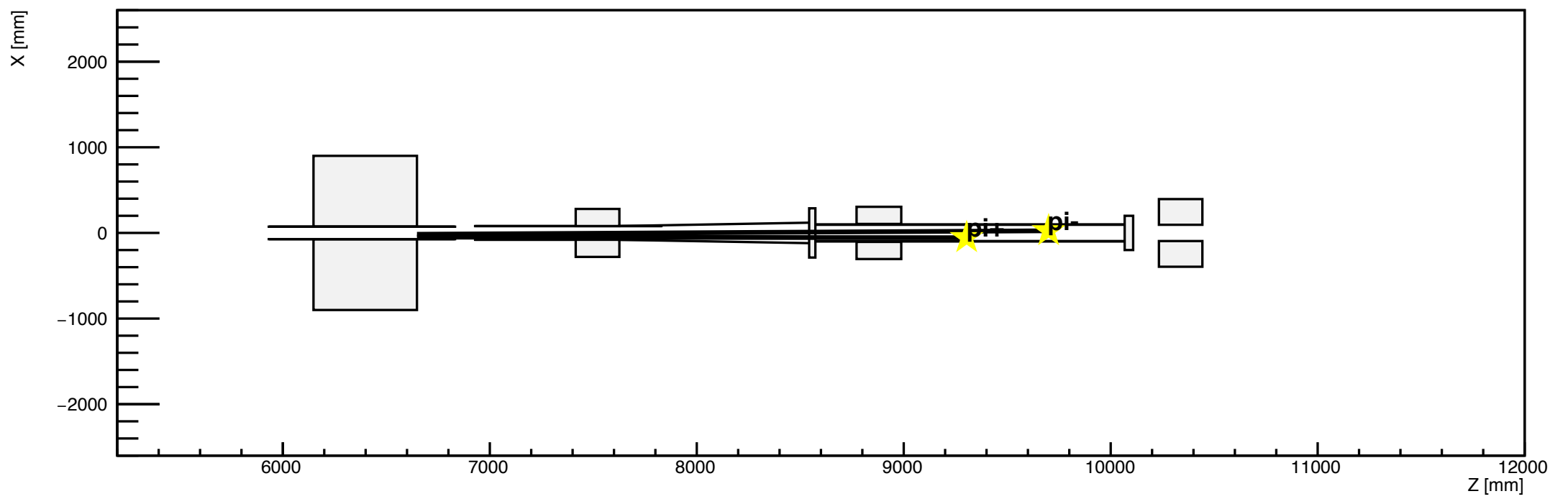

h1

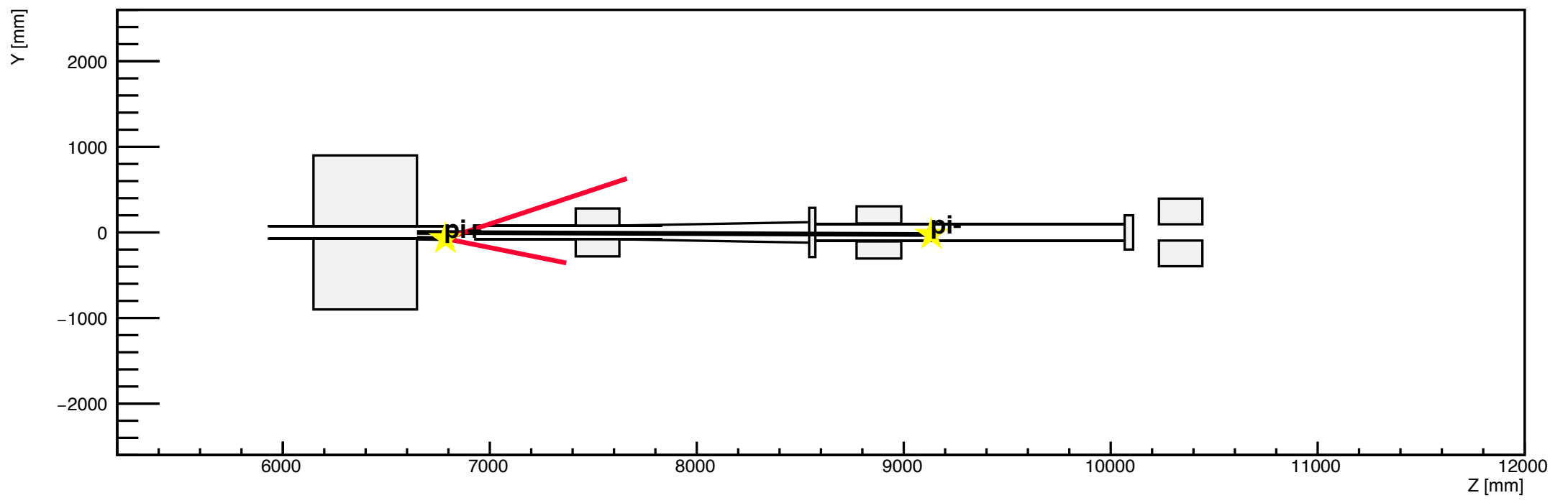

h2

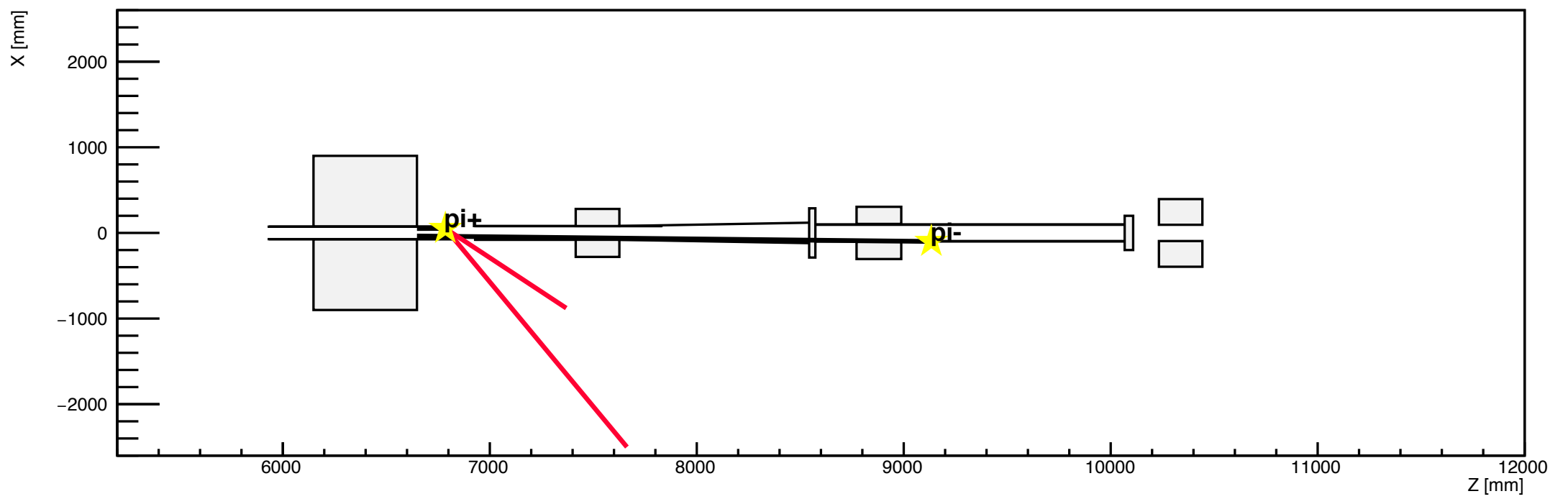

h1

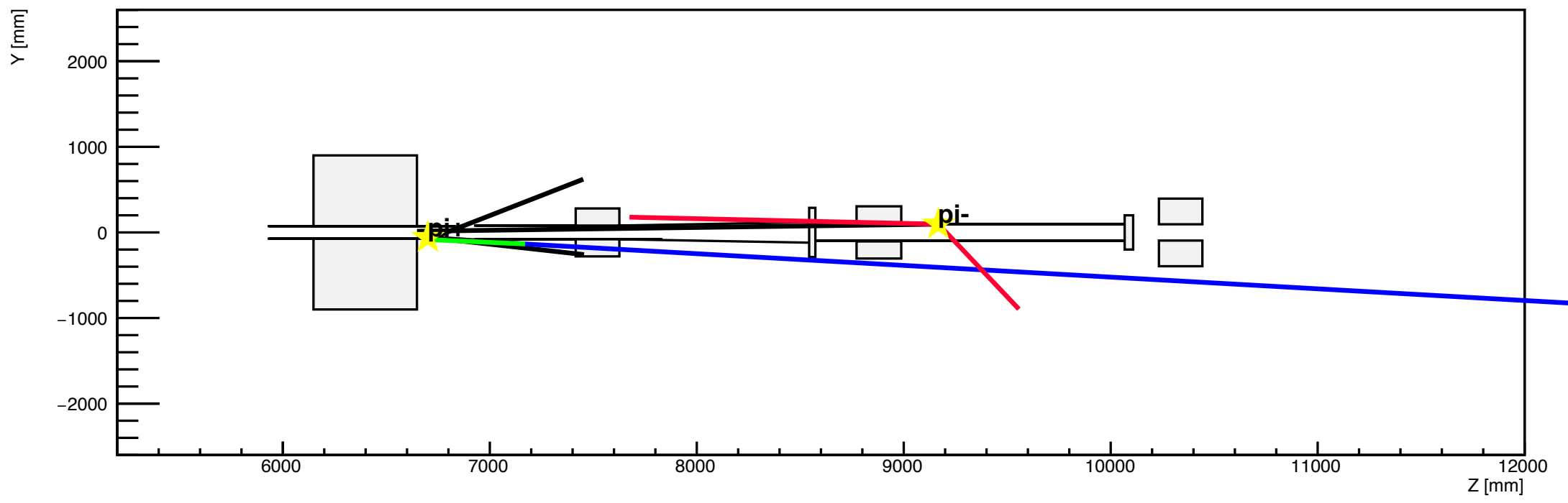

h2

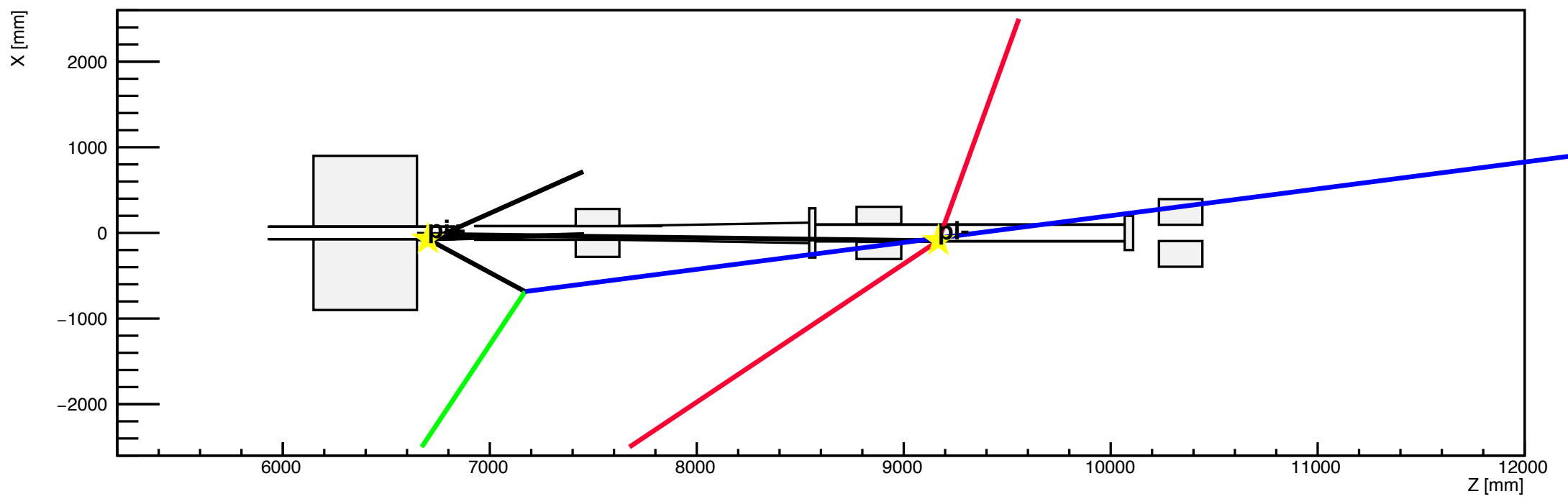

h1

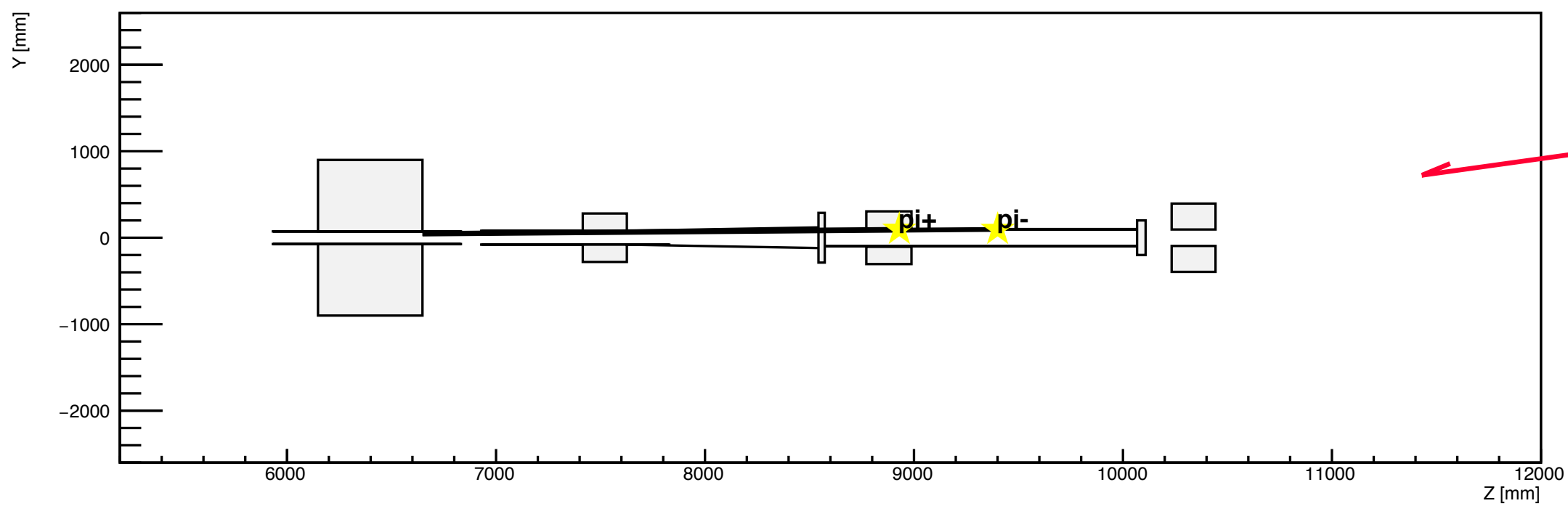

h2

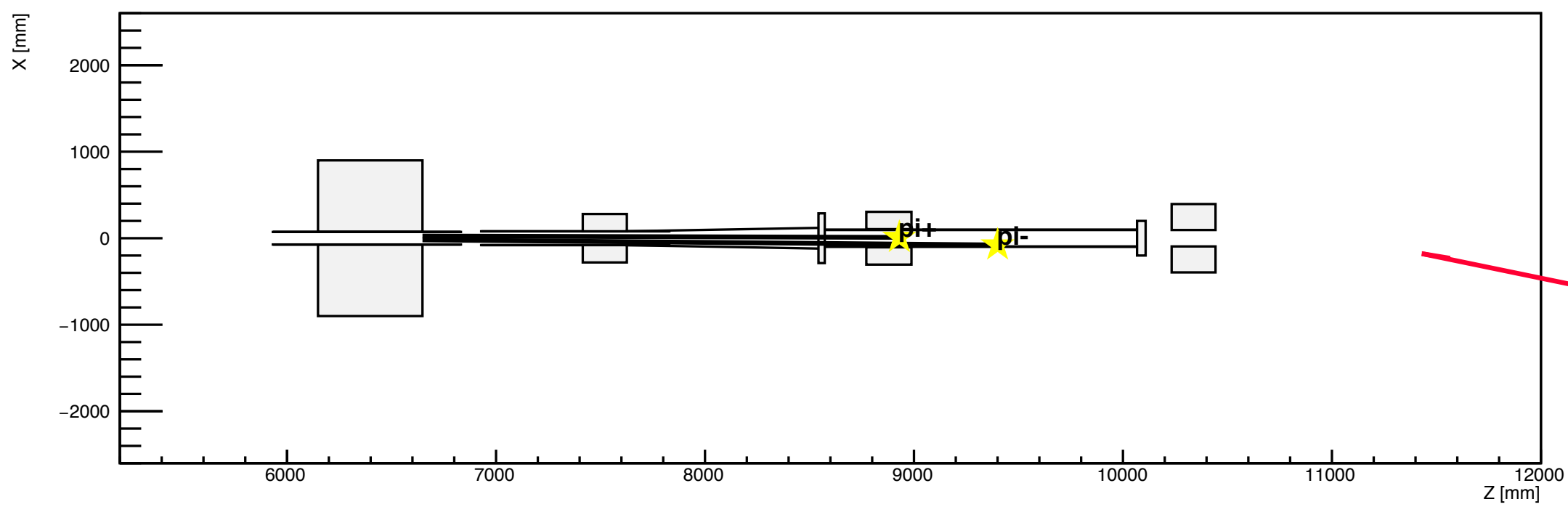

h1

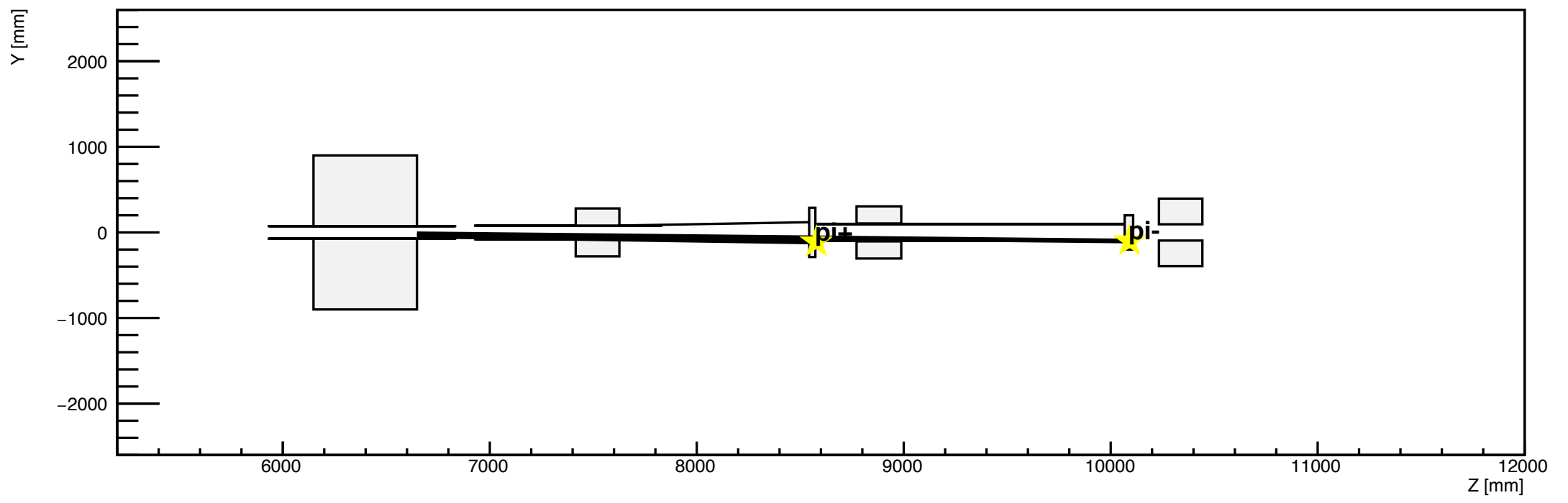

h2

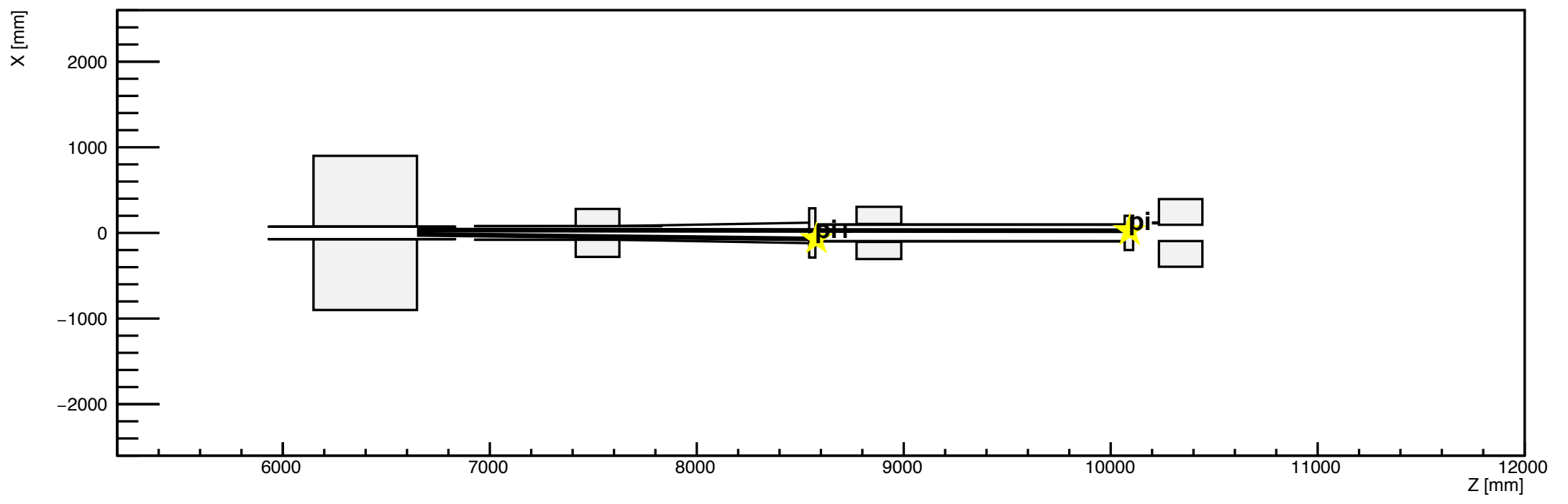

h1

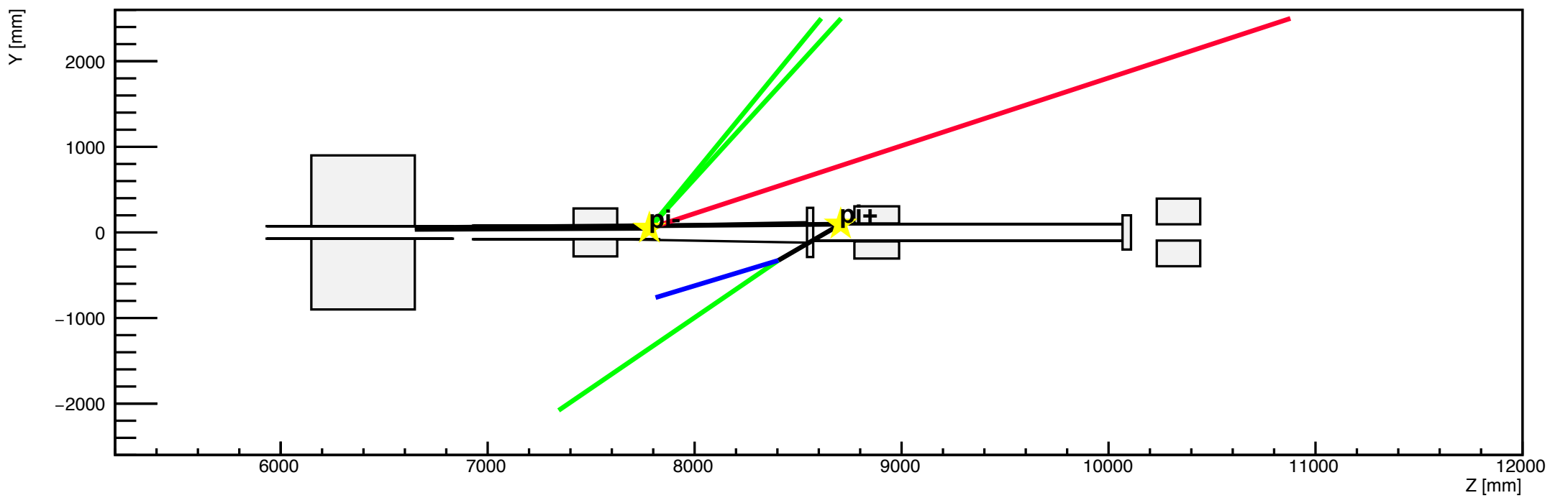

h2

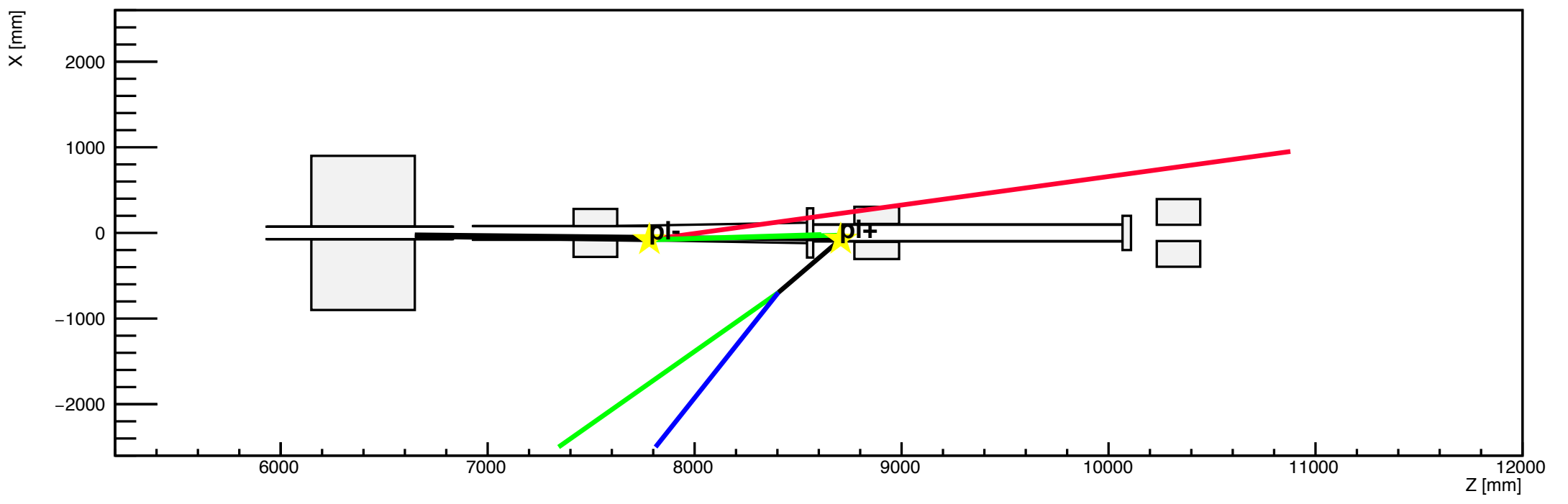

h1

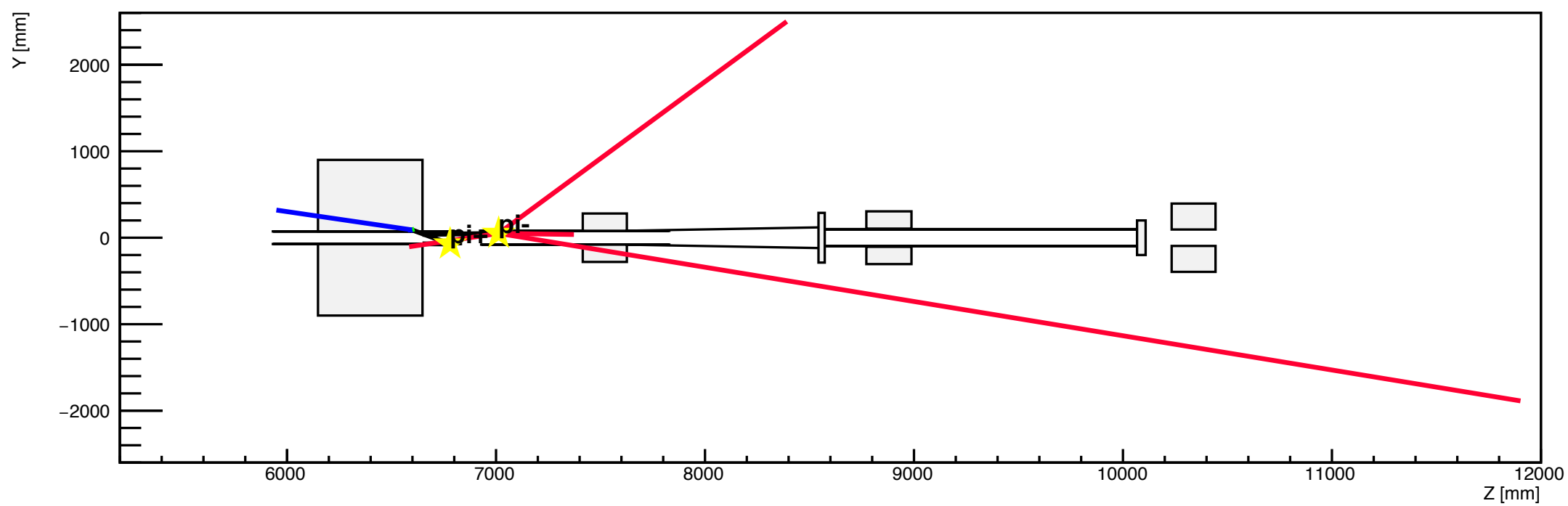

h2

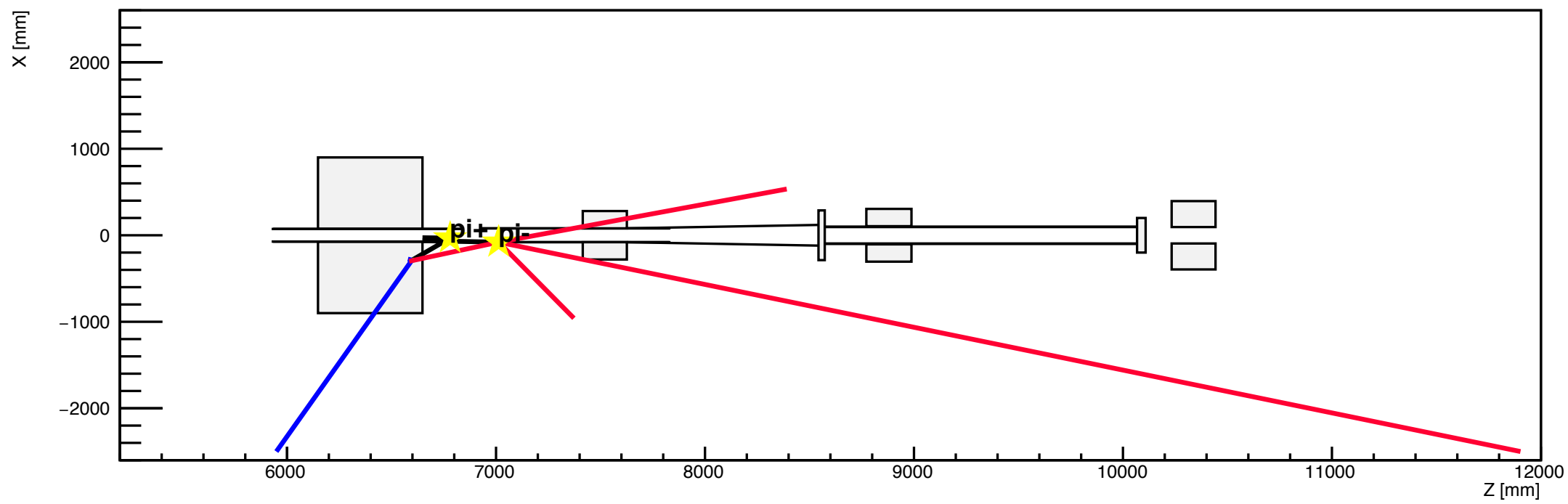

h1

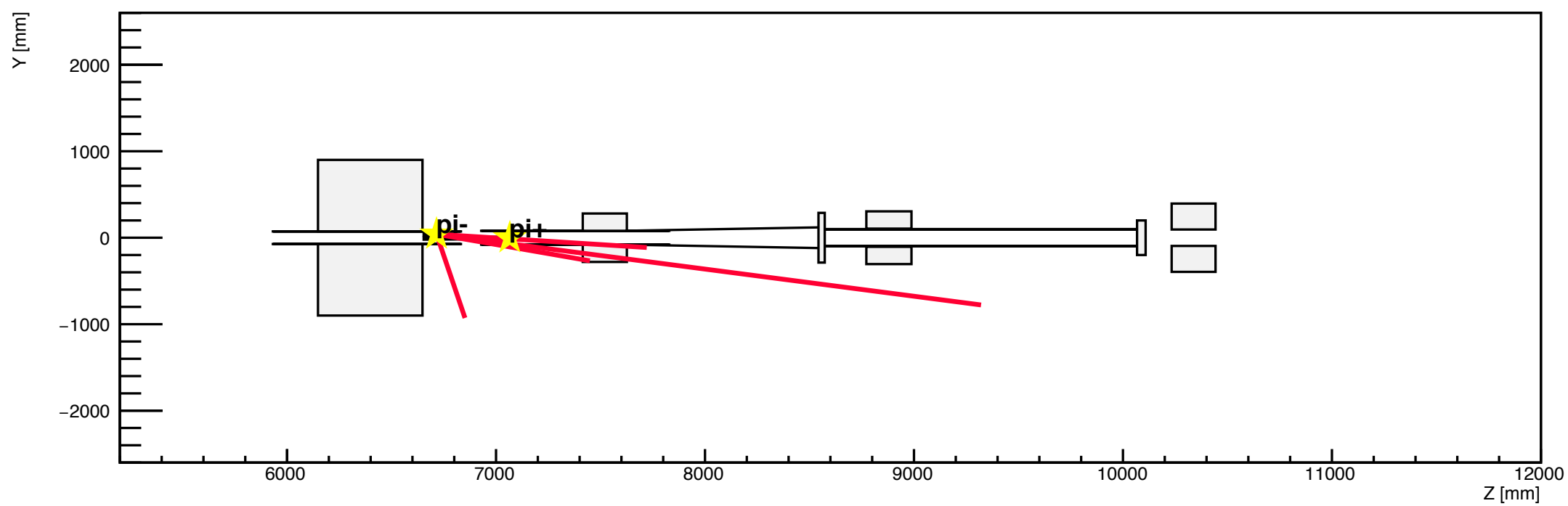

h2

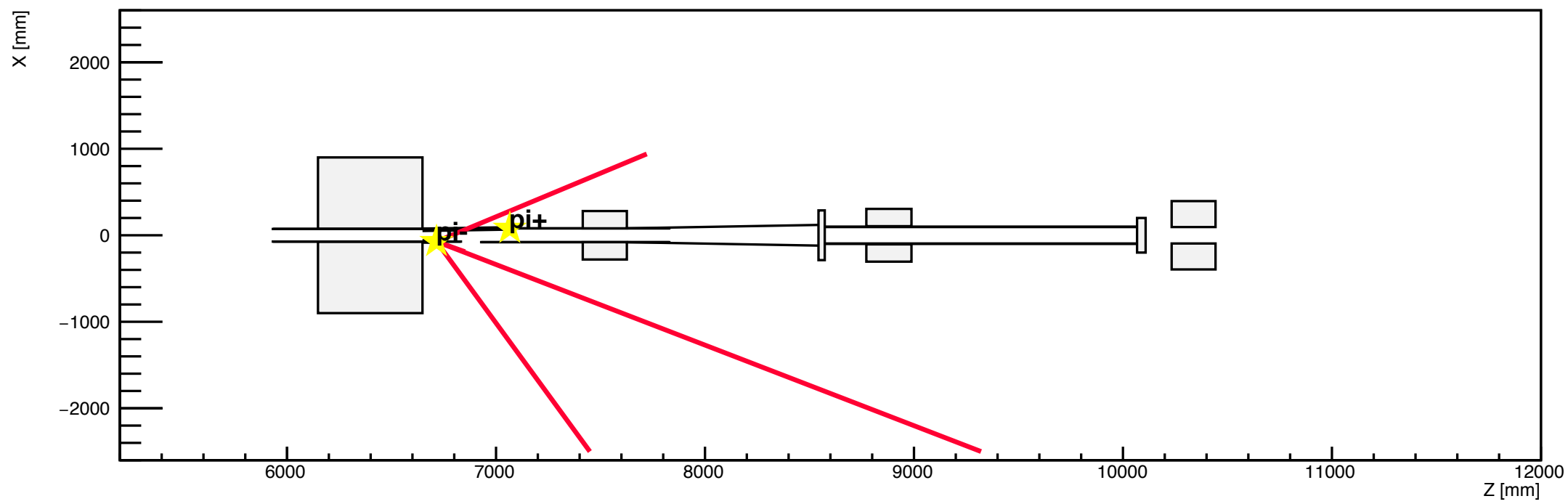

h1

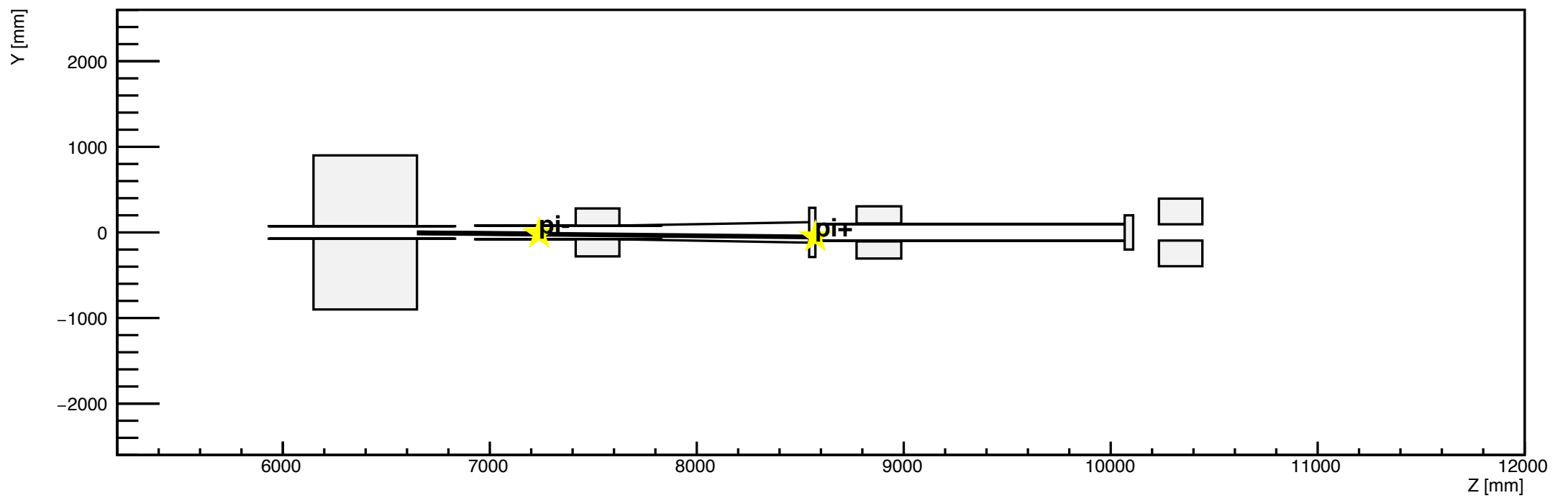

h2

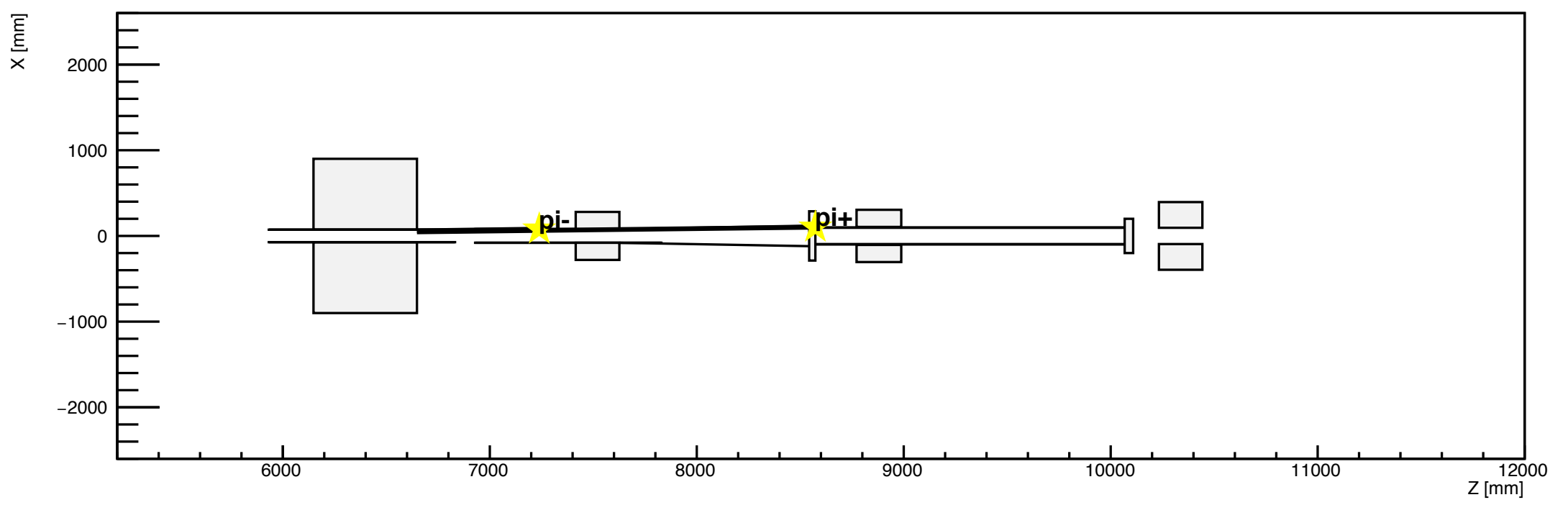

h1

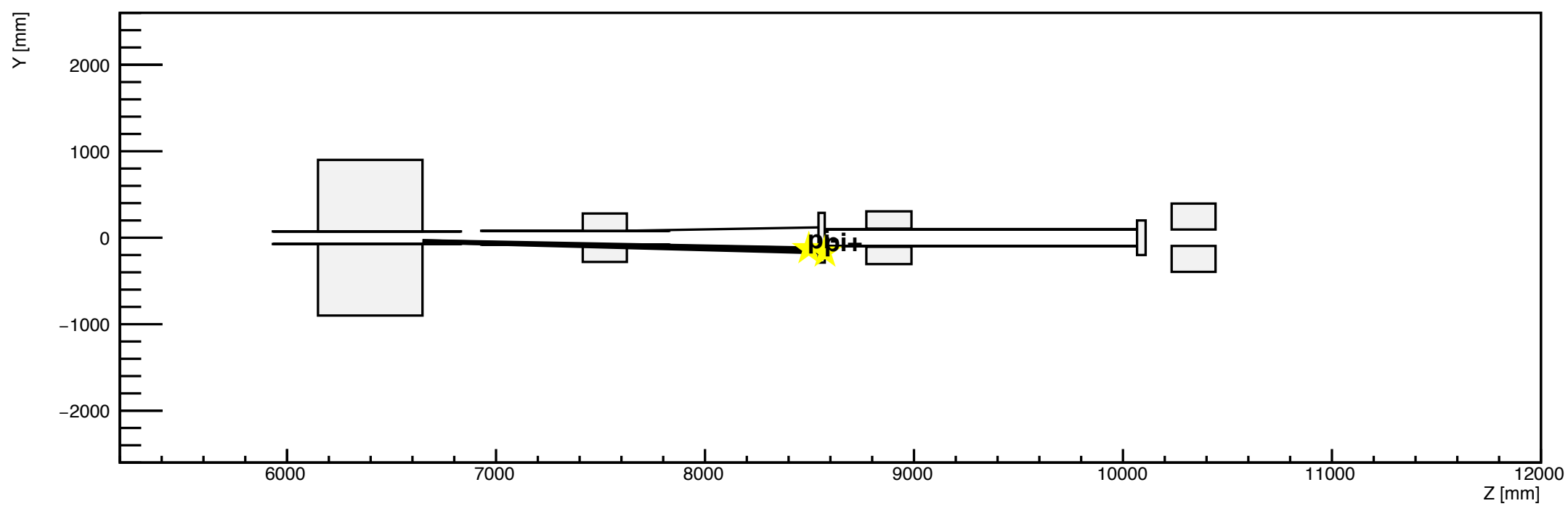

h2

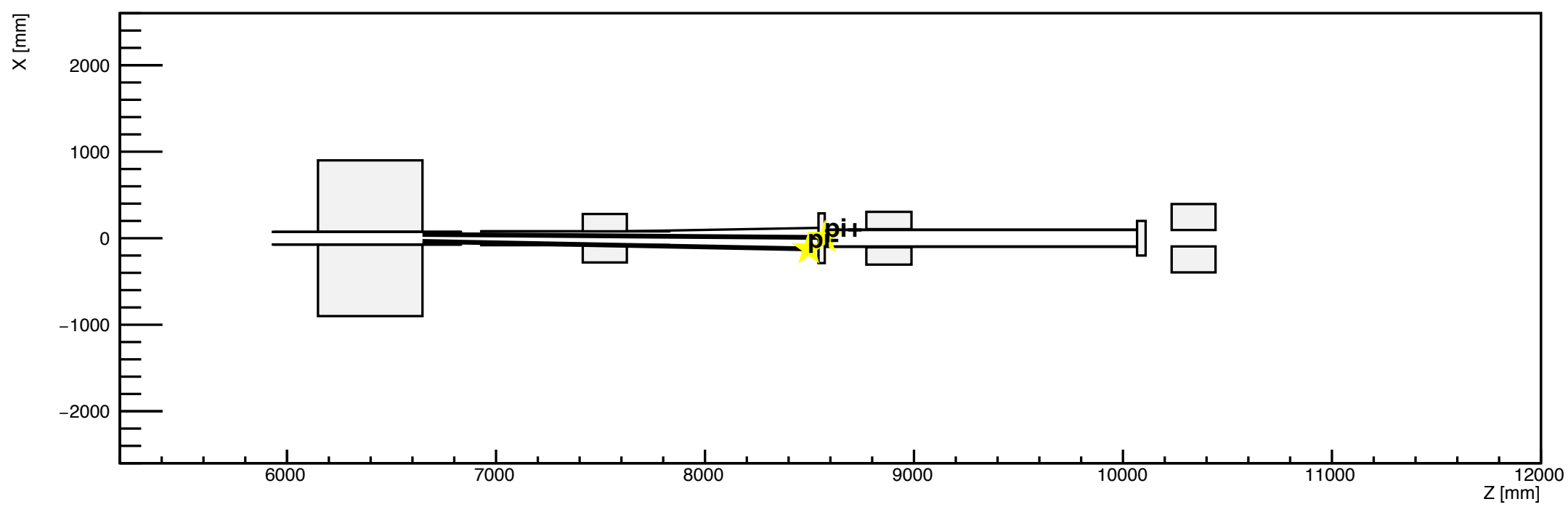

h1

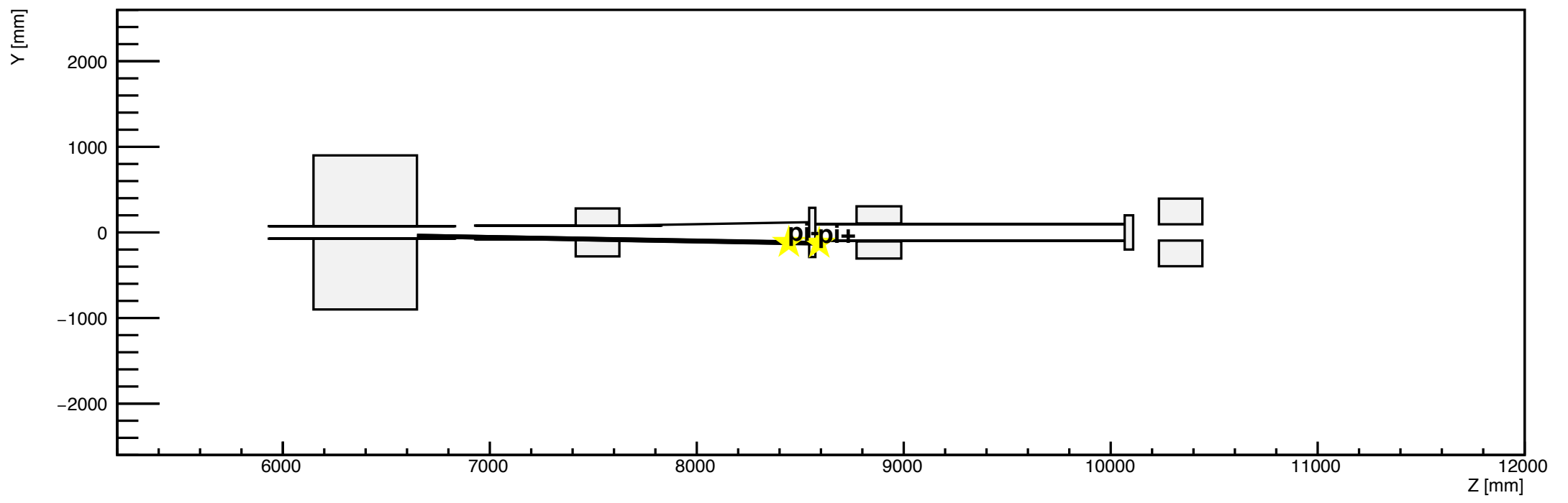

h2

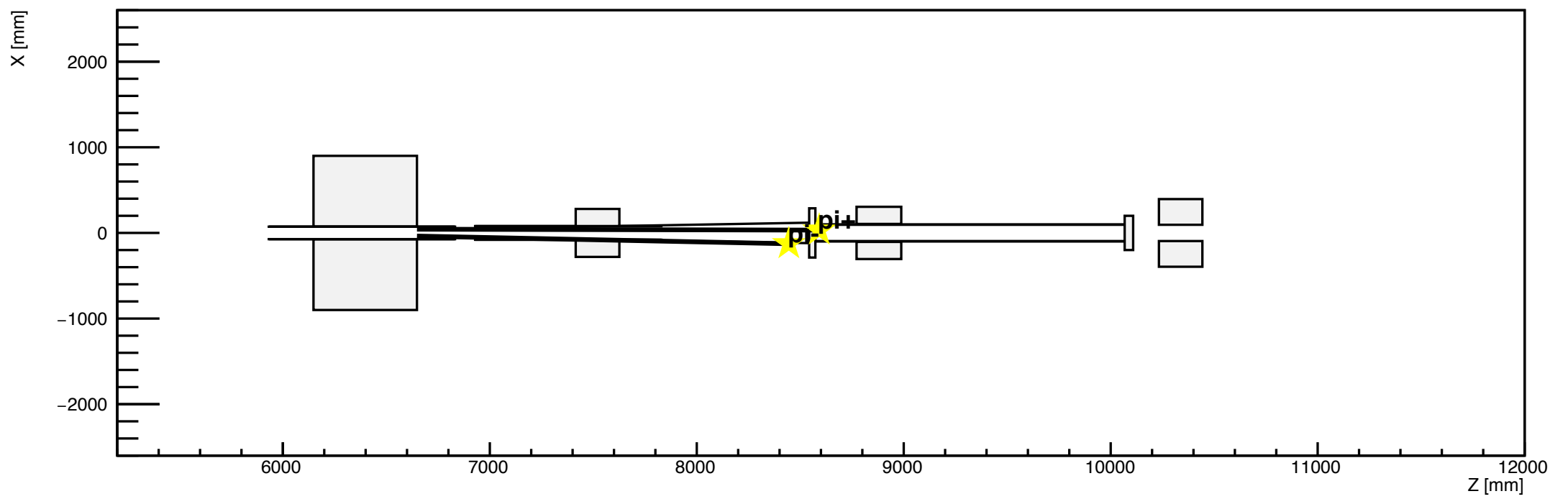

h1

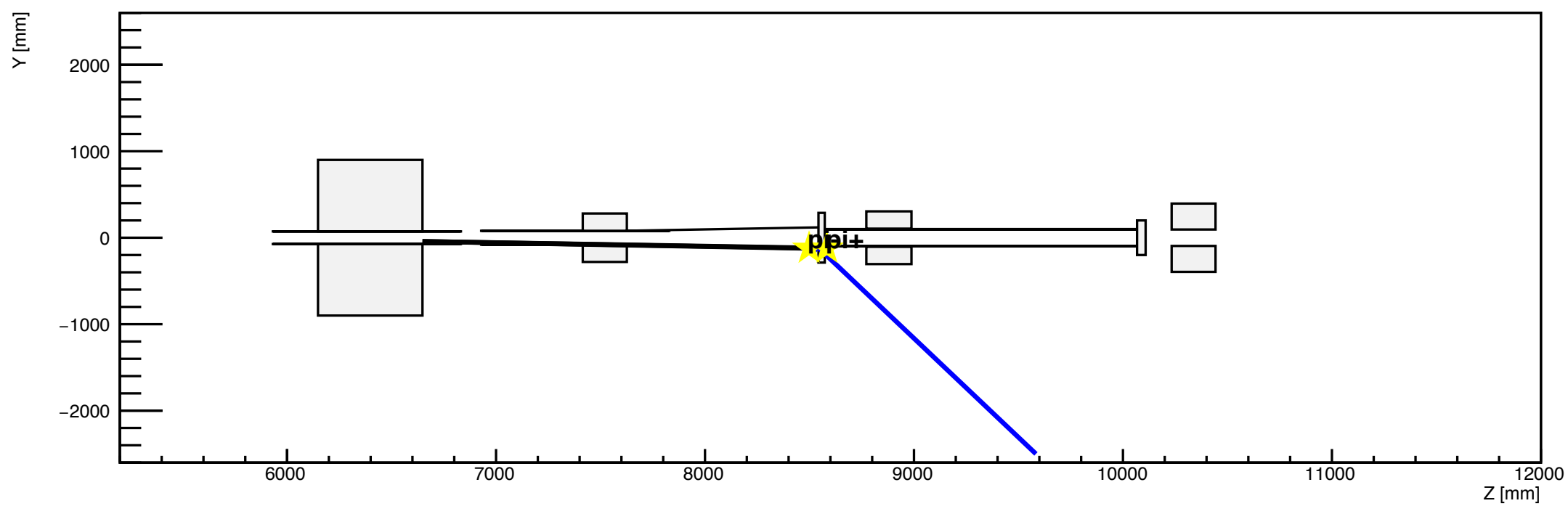

h2

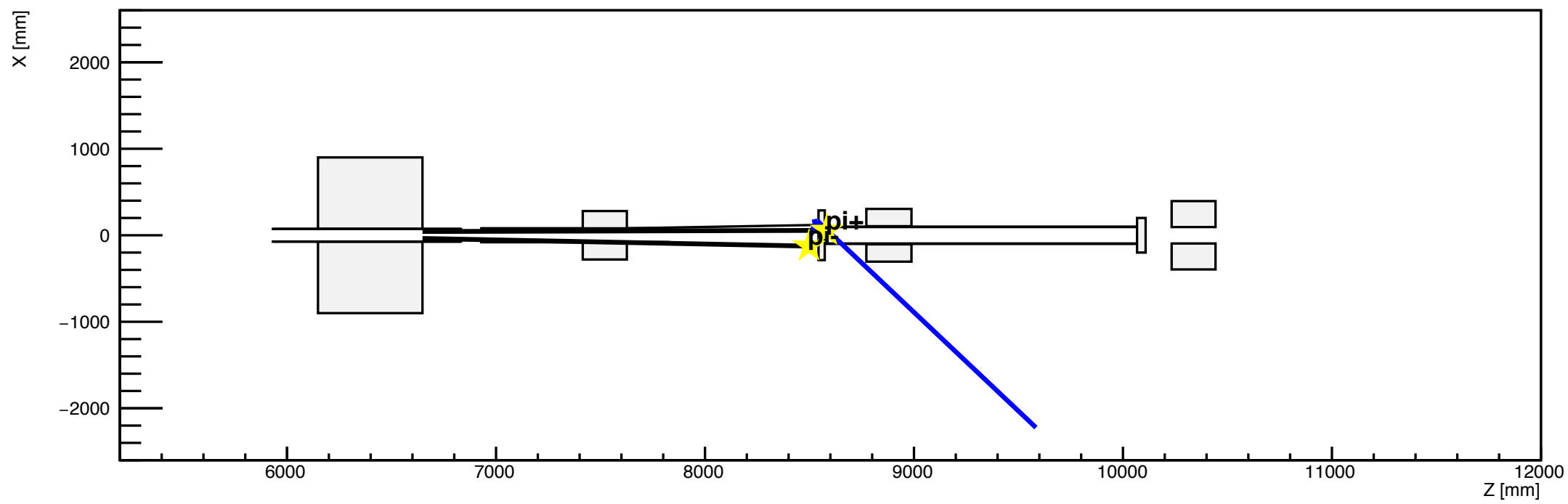

h1

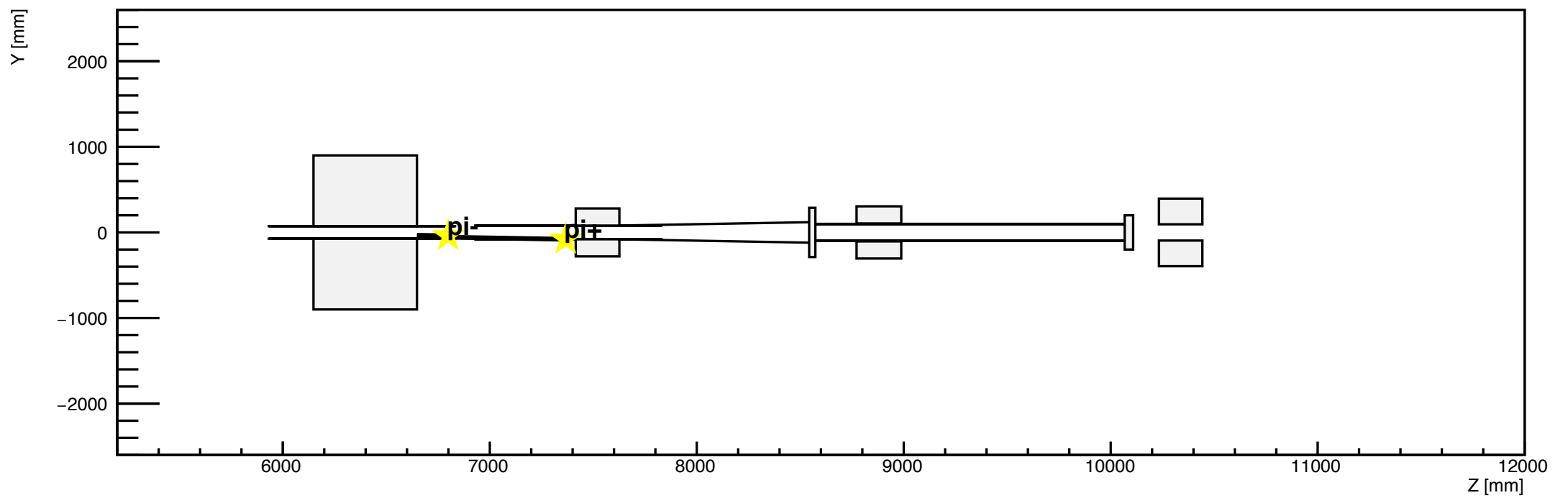

h2

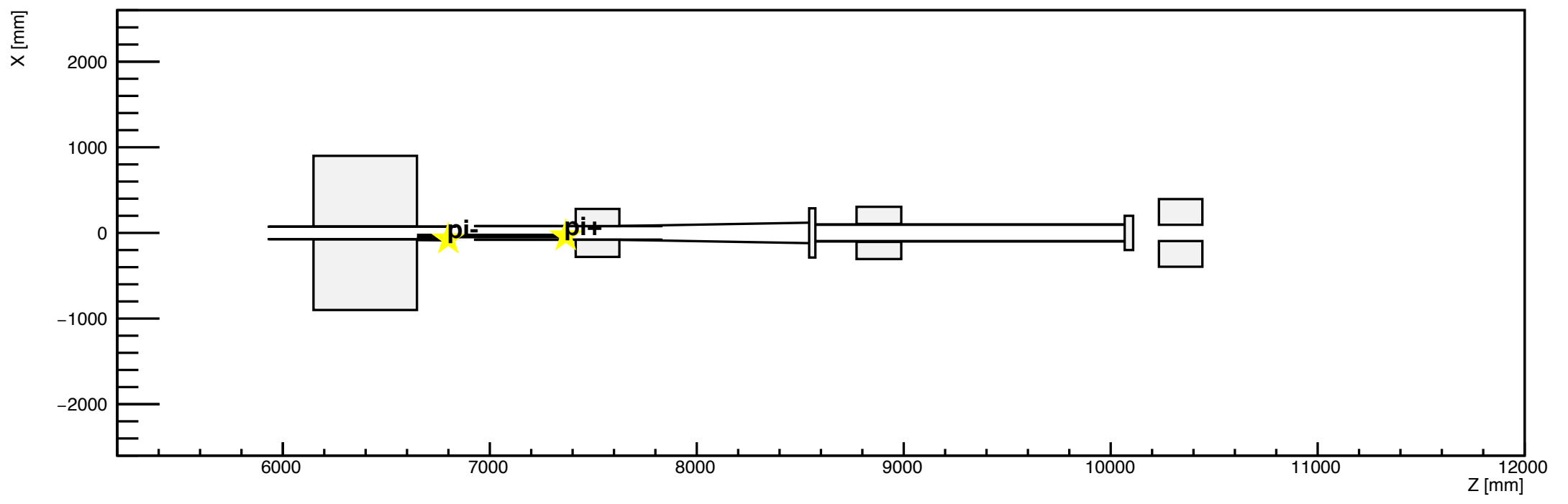

h1

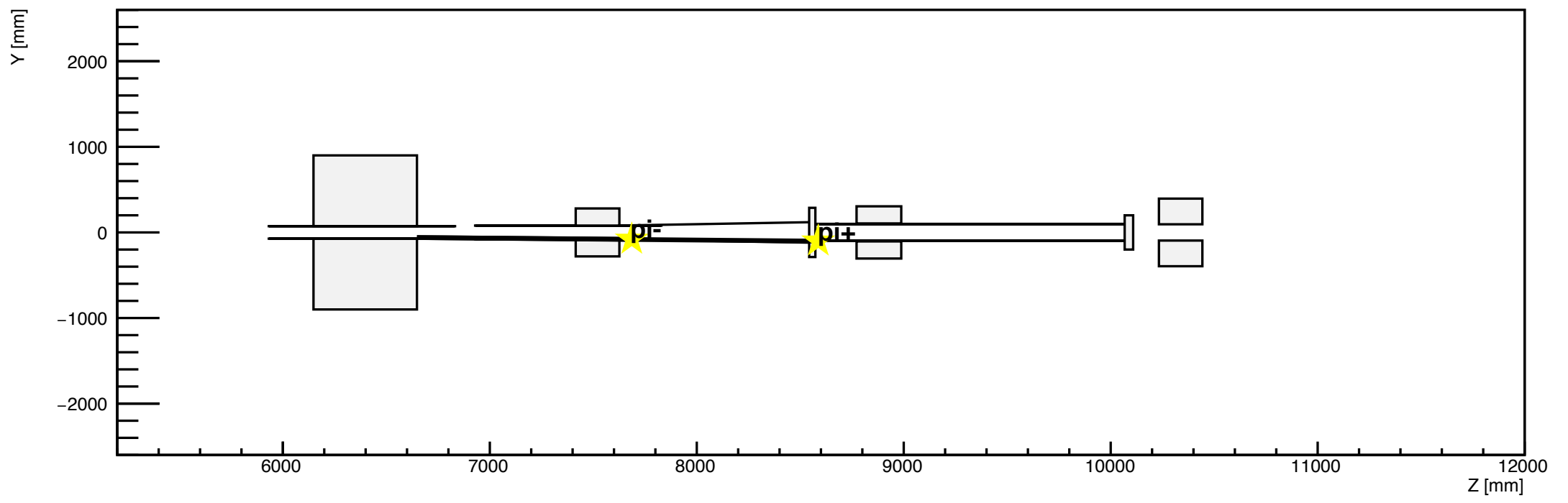

h2

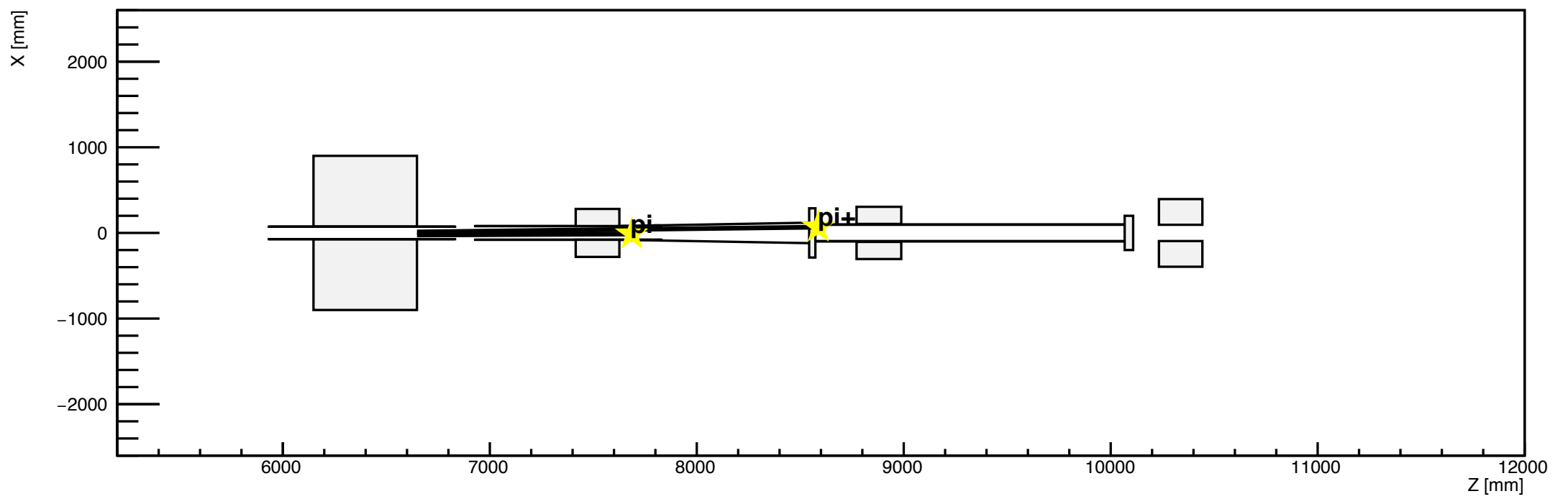

h1

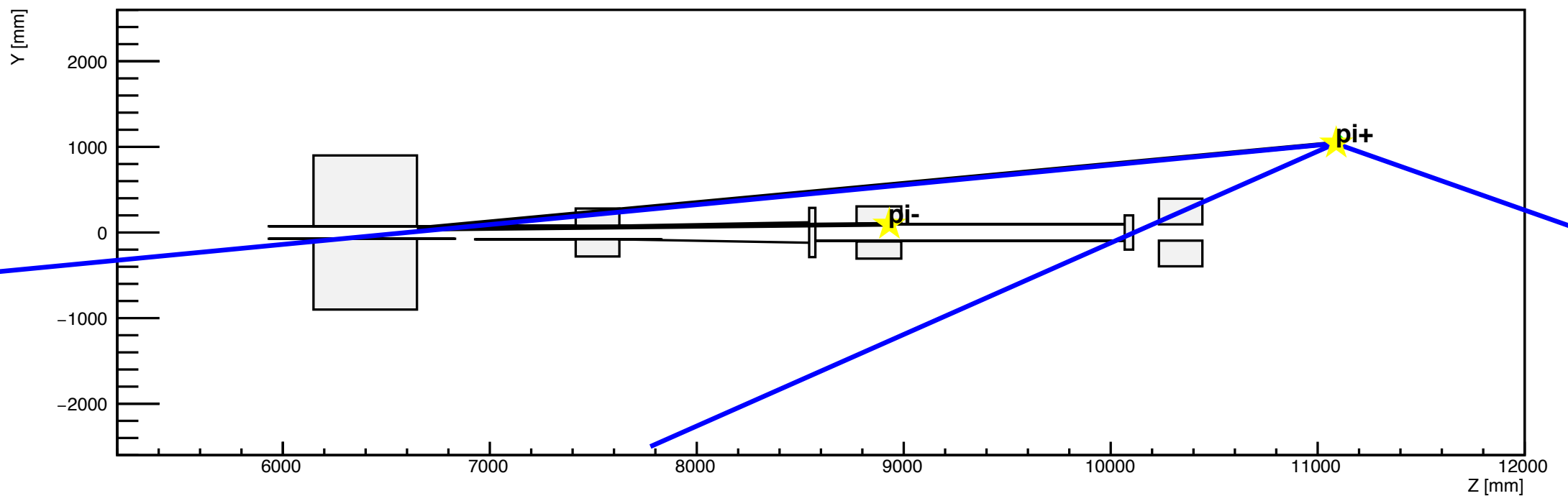

h2

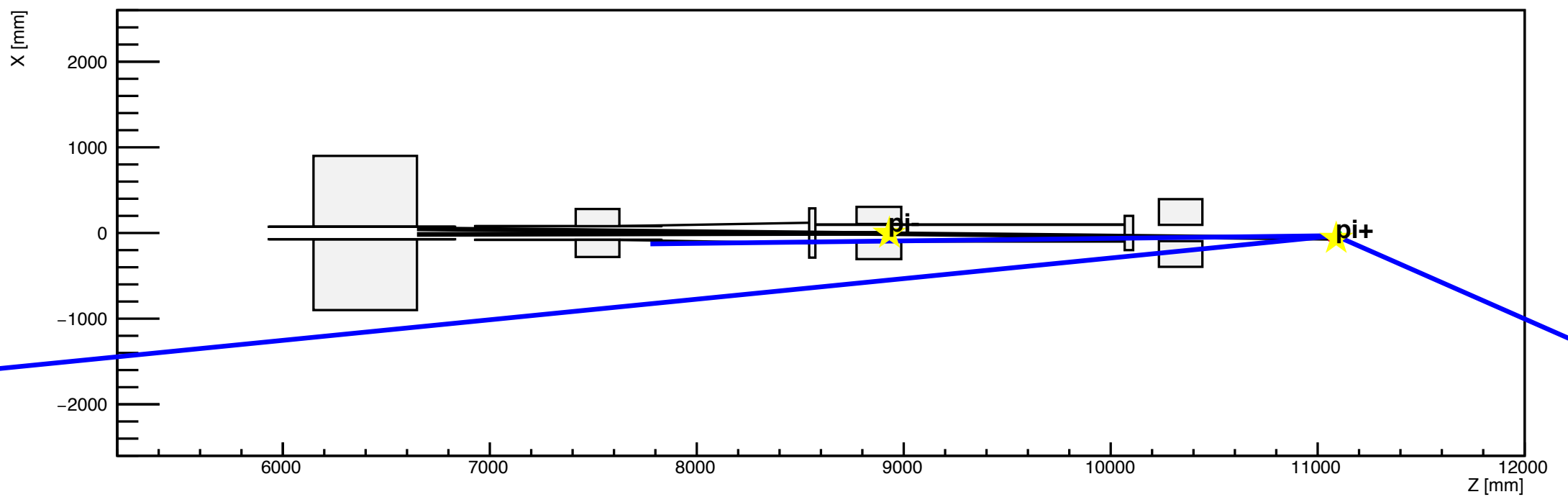

h1

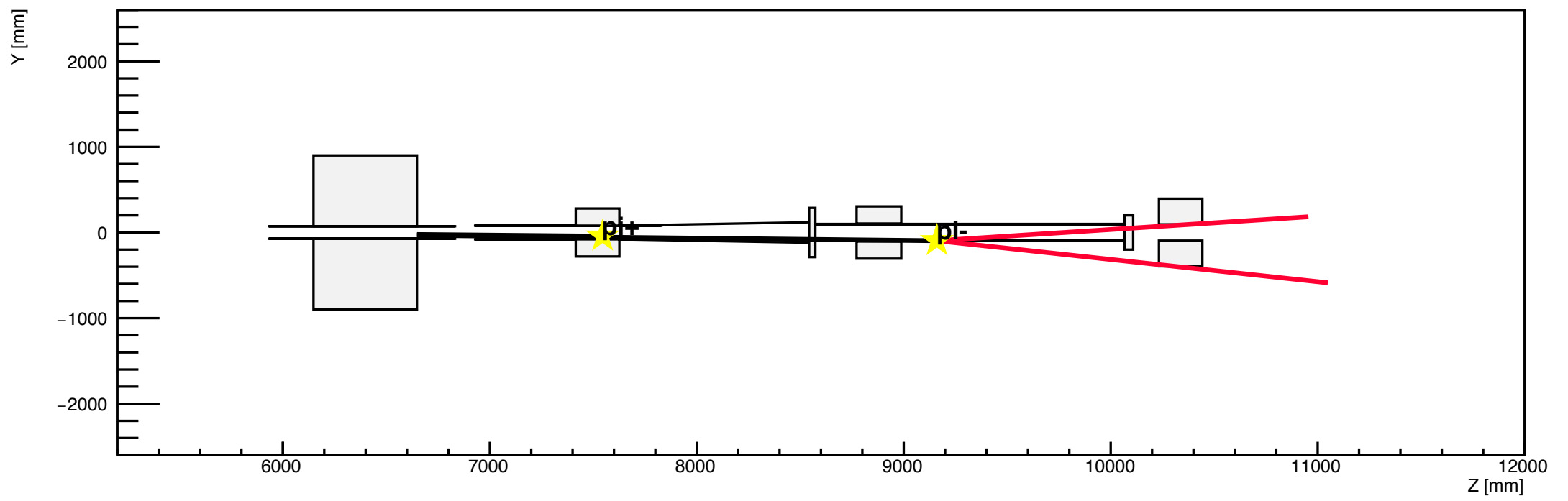

h2

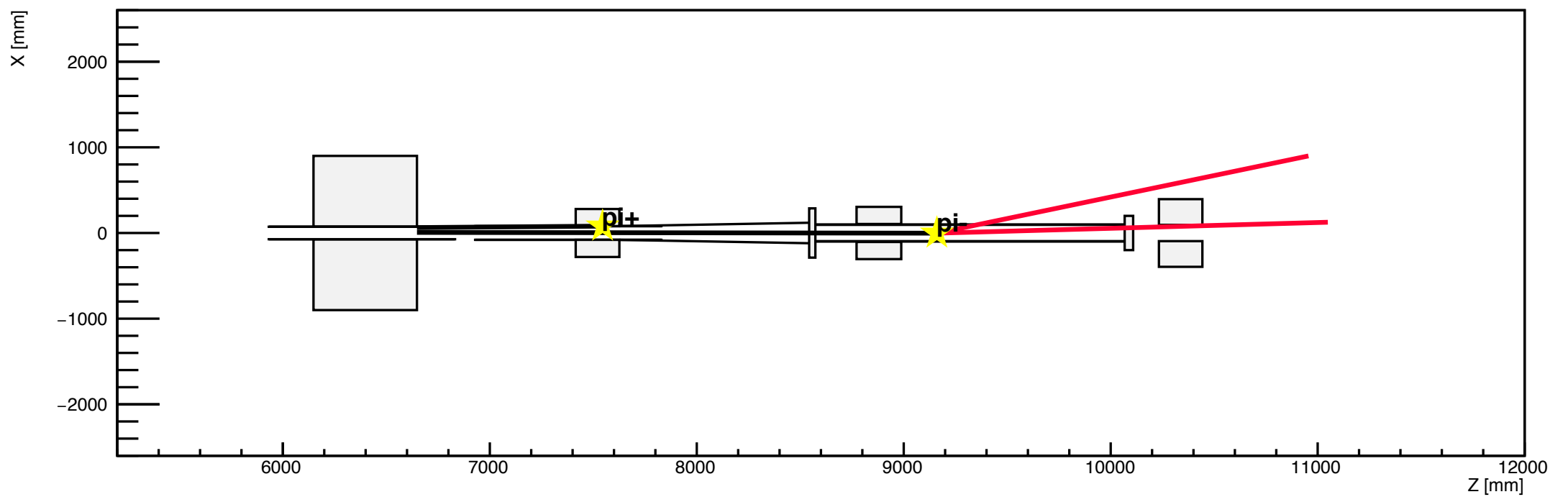

h1

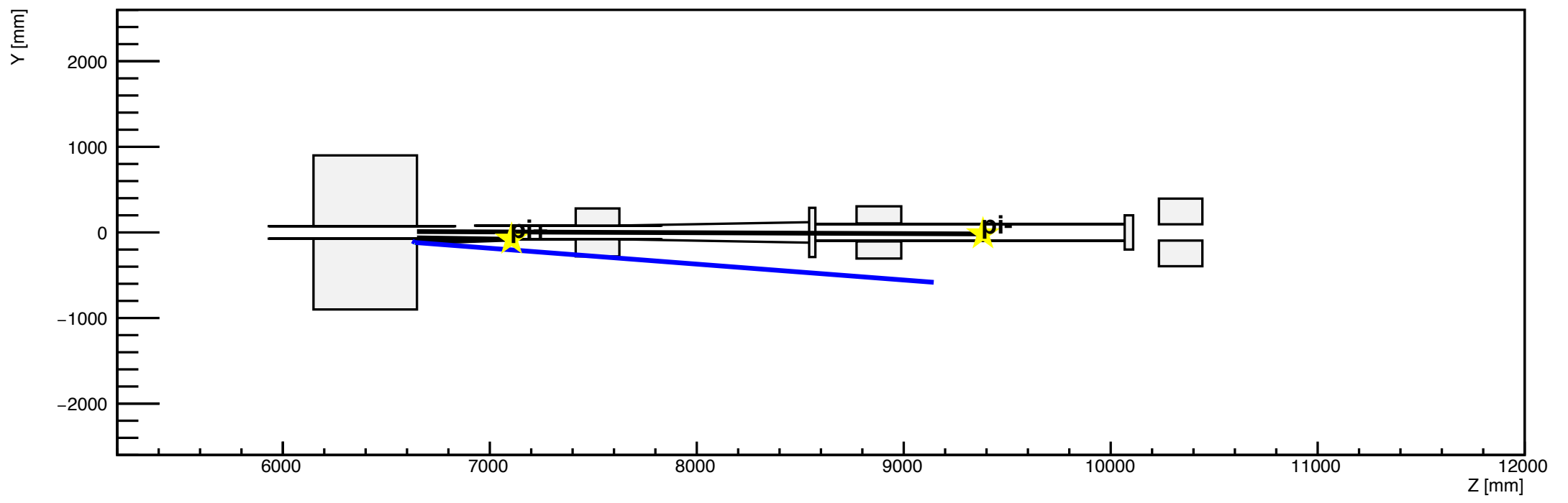

h2

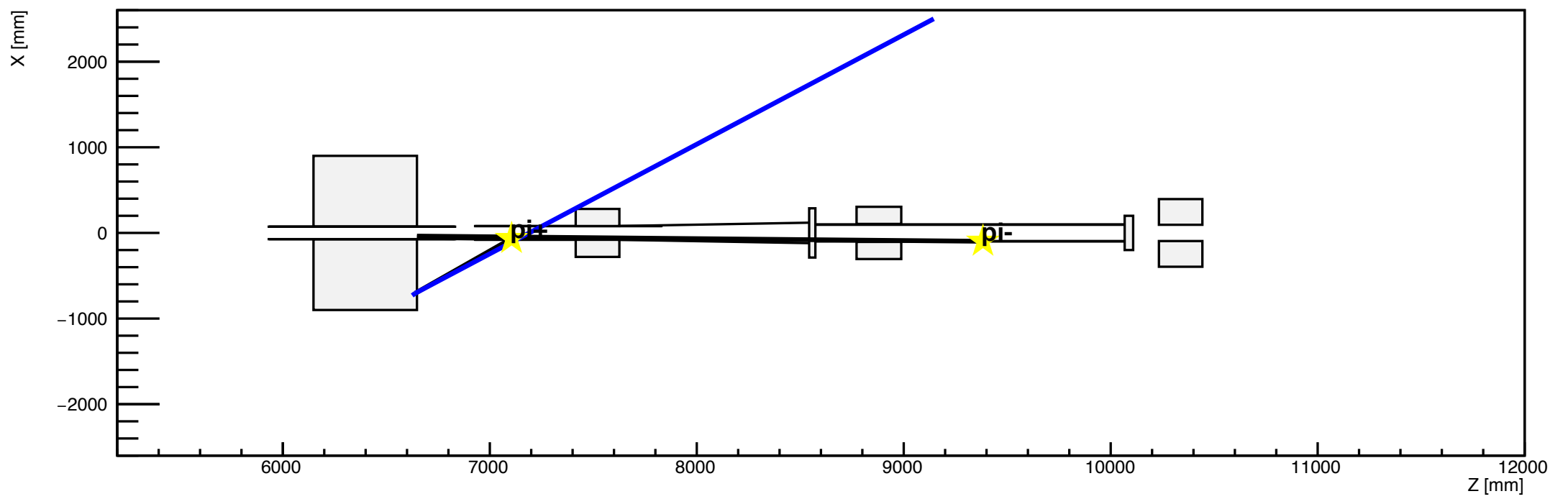

h1

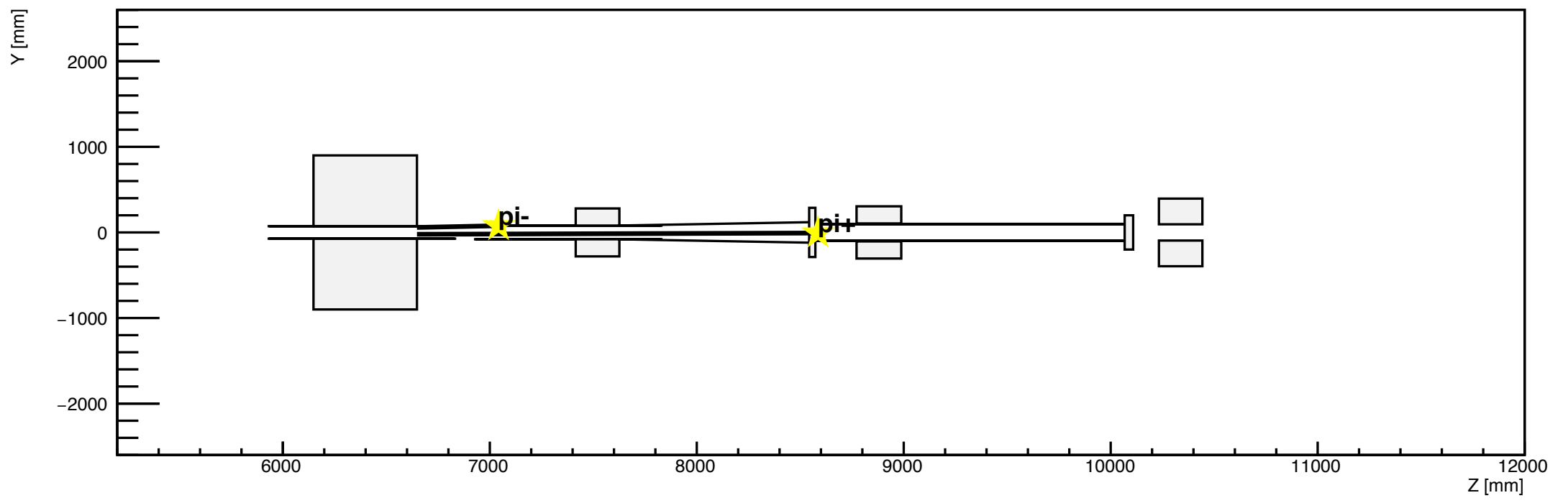

h2

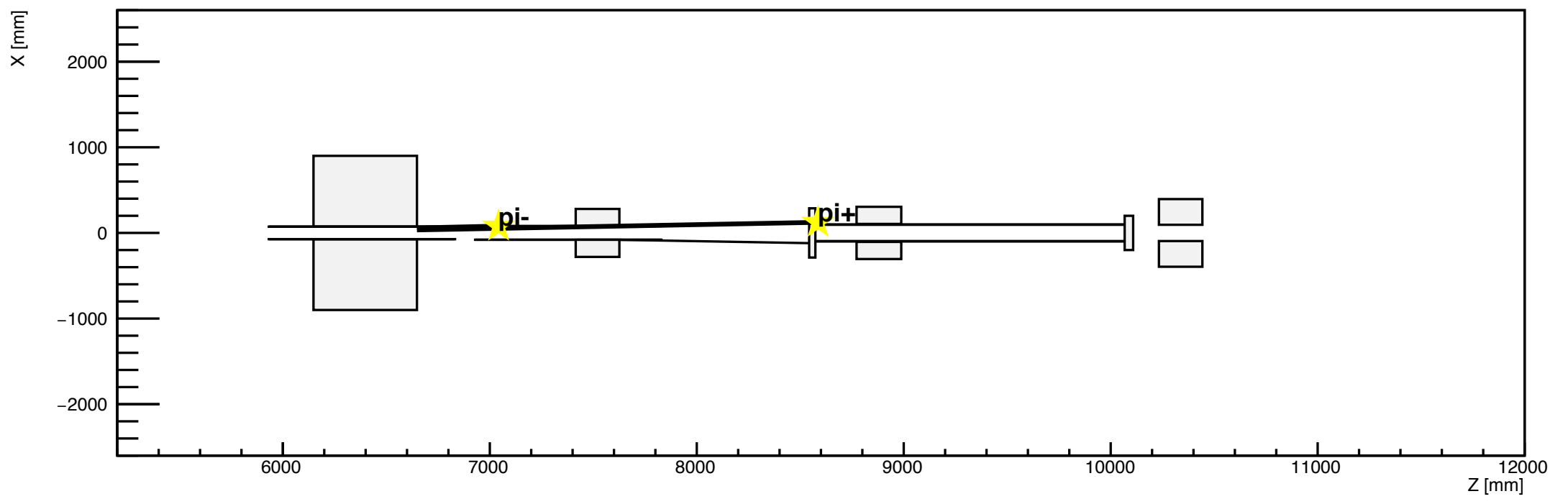

h1

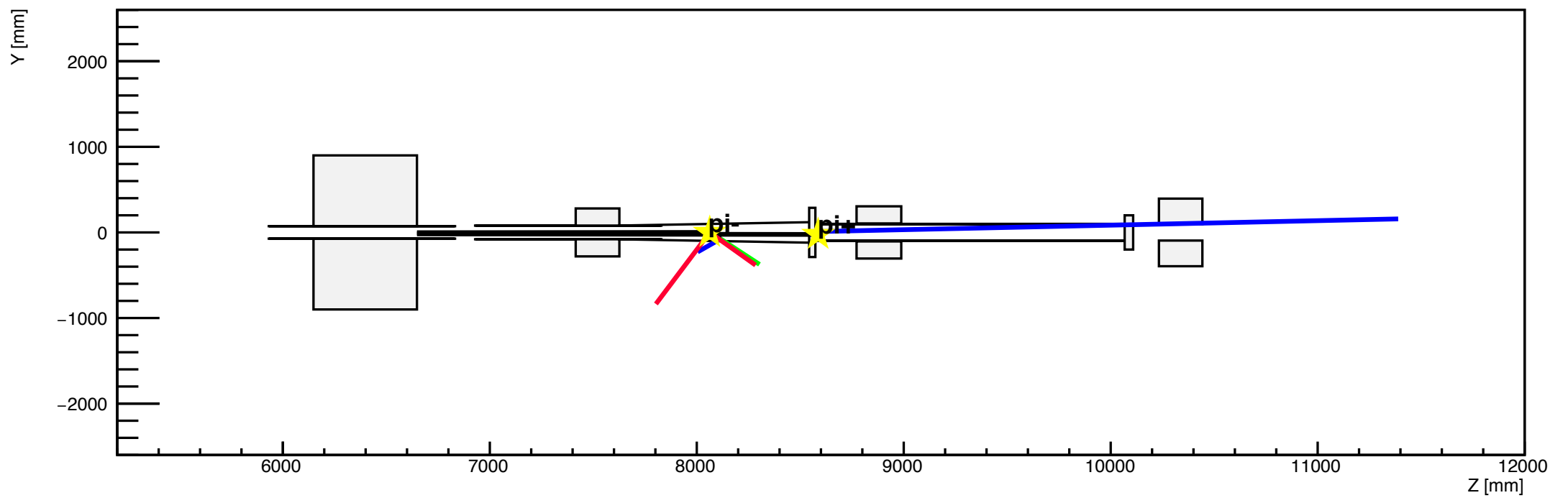

h2

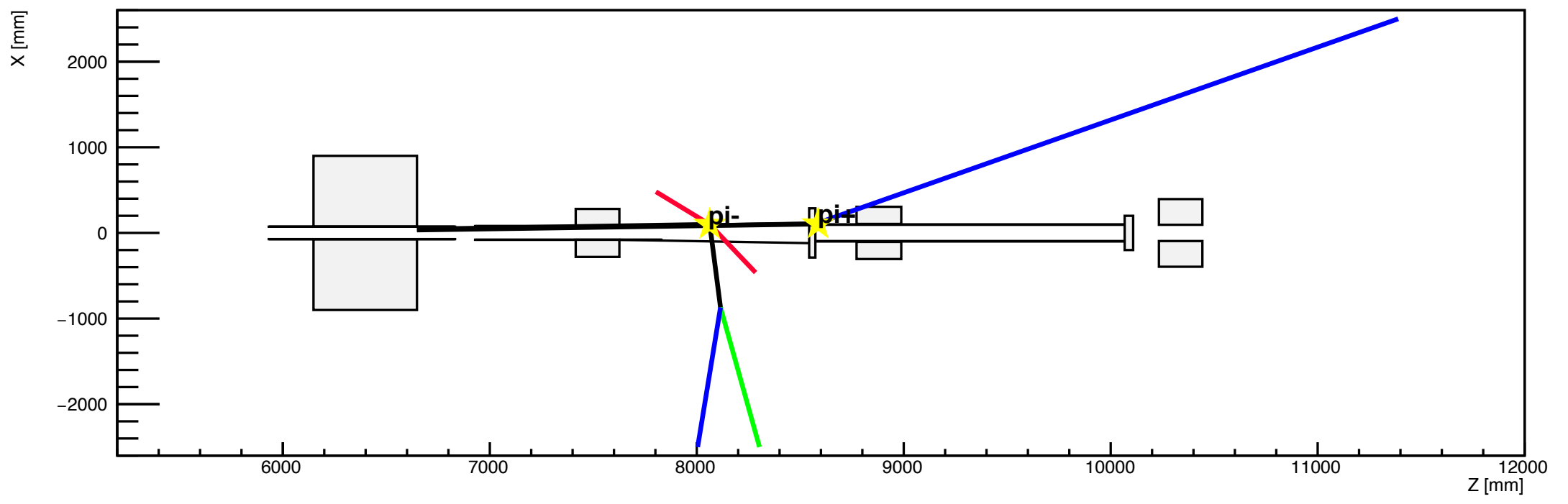

h1

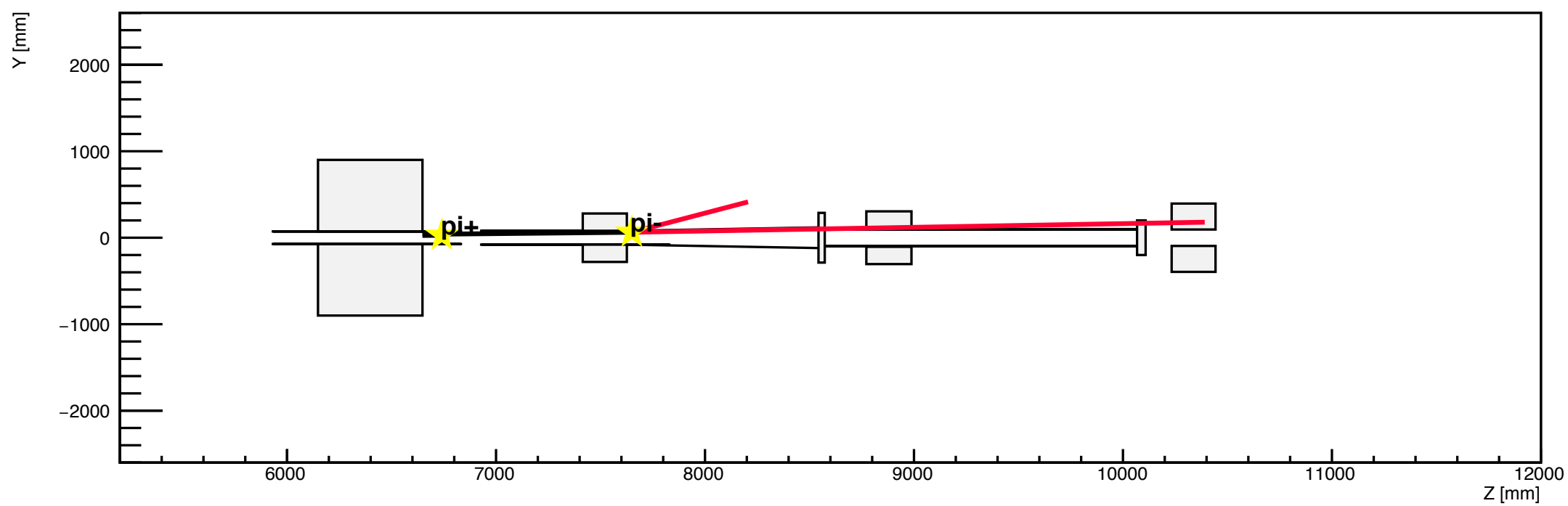

h2

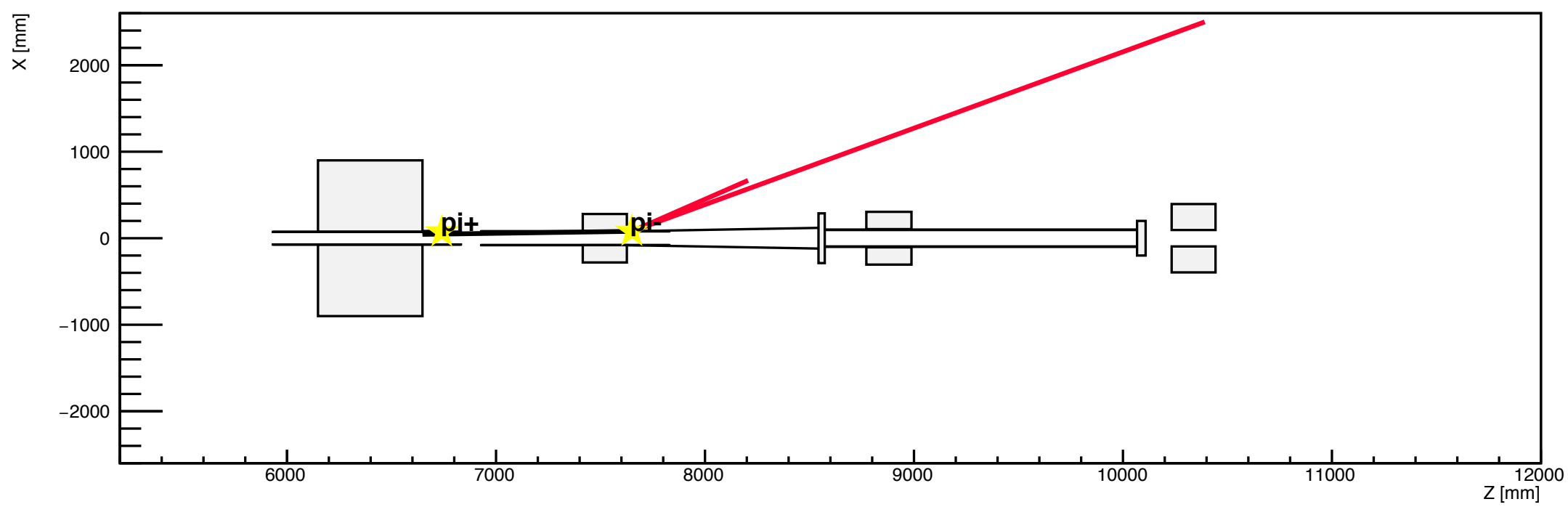

h1

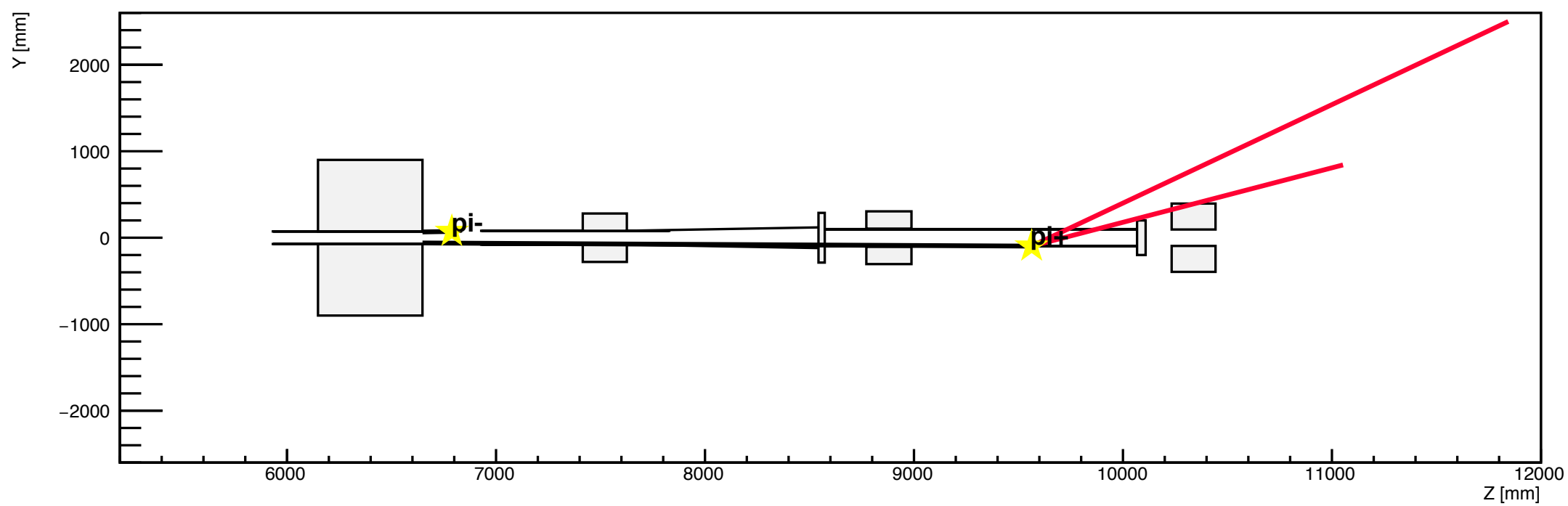

h2

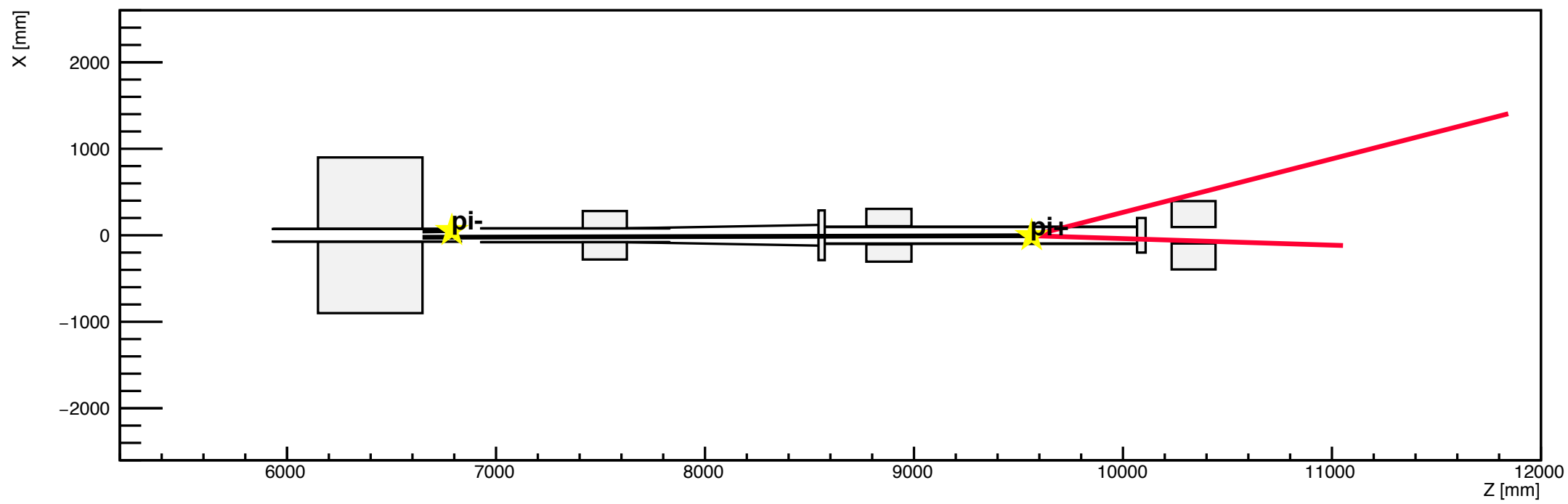

h1

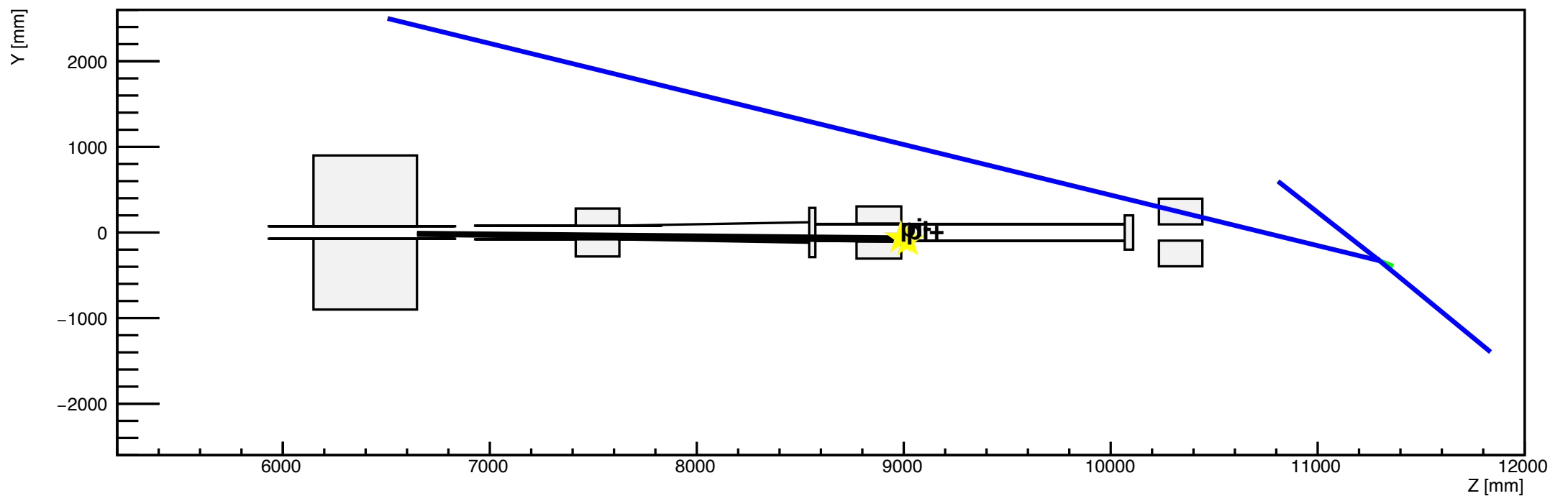

h2

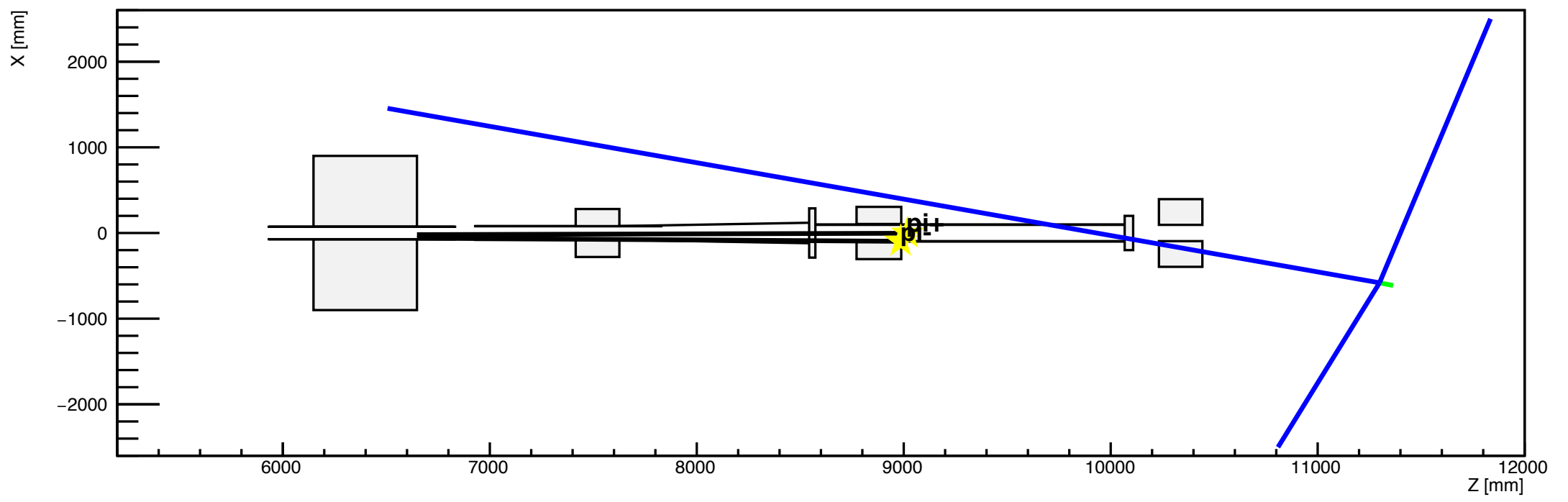

h1

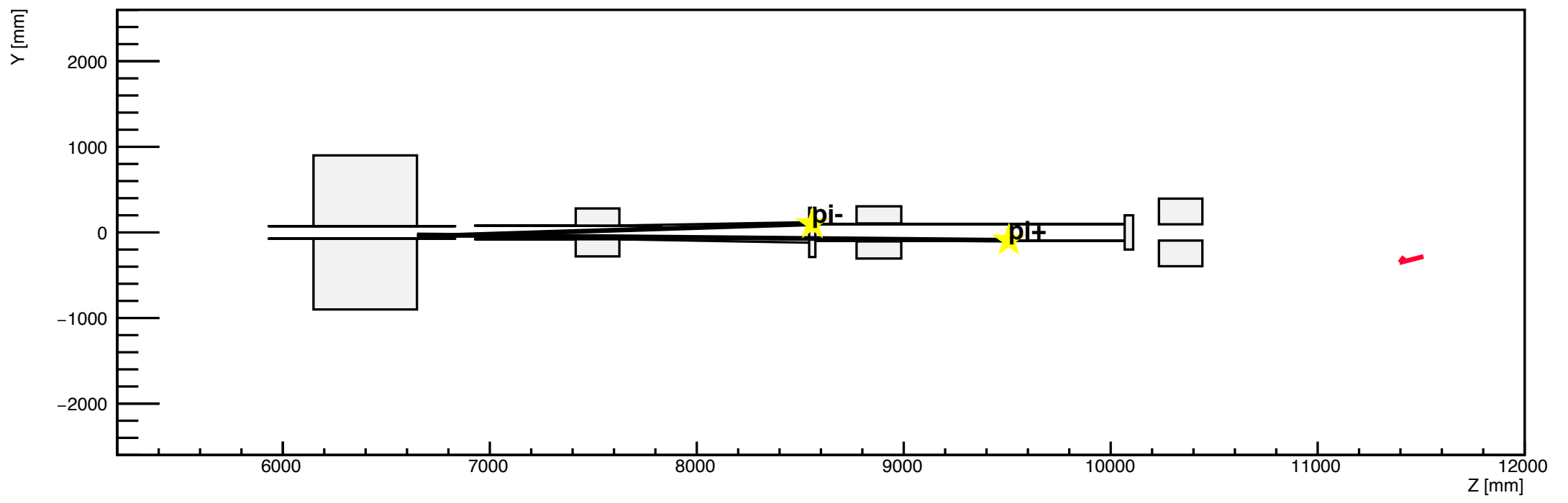

h2

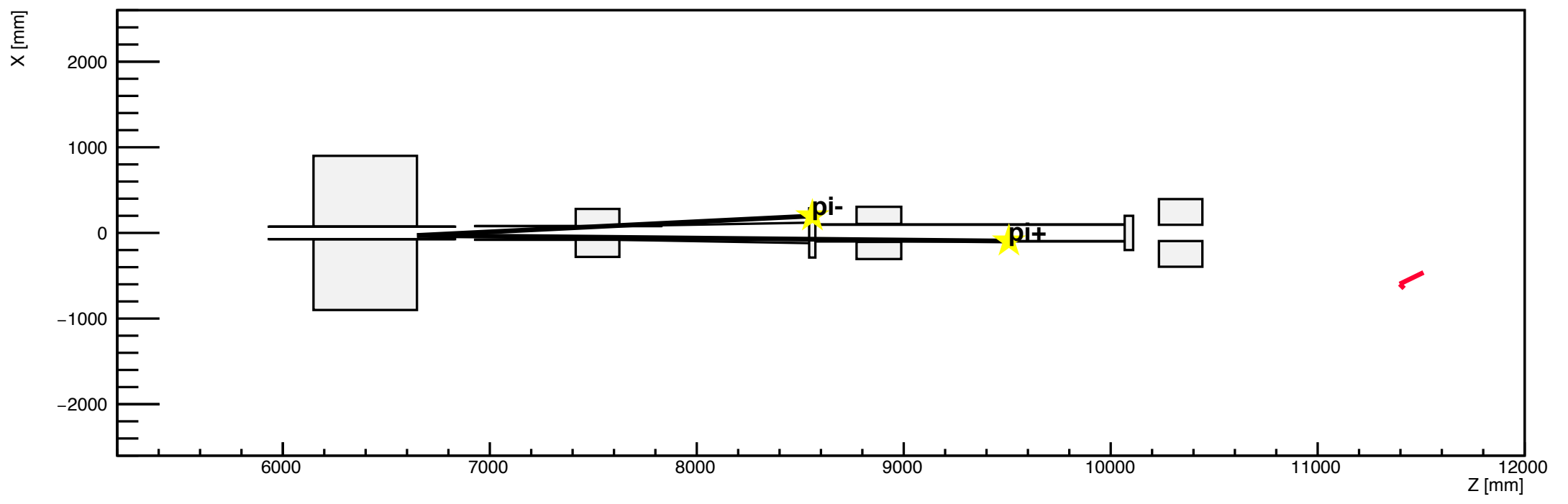

h1

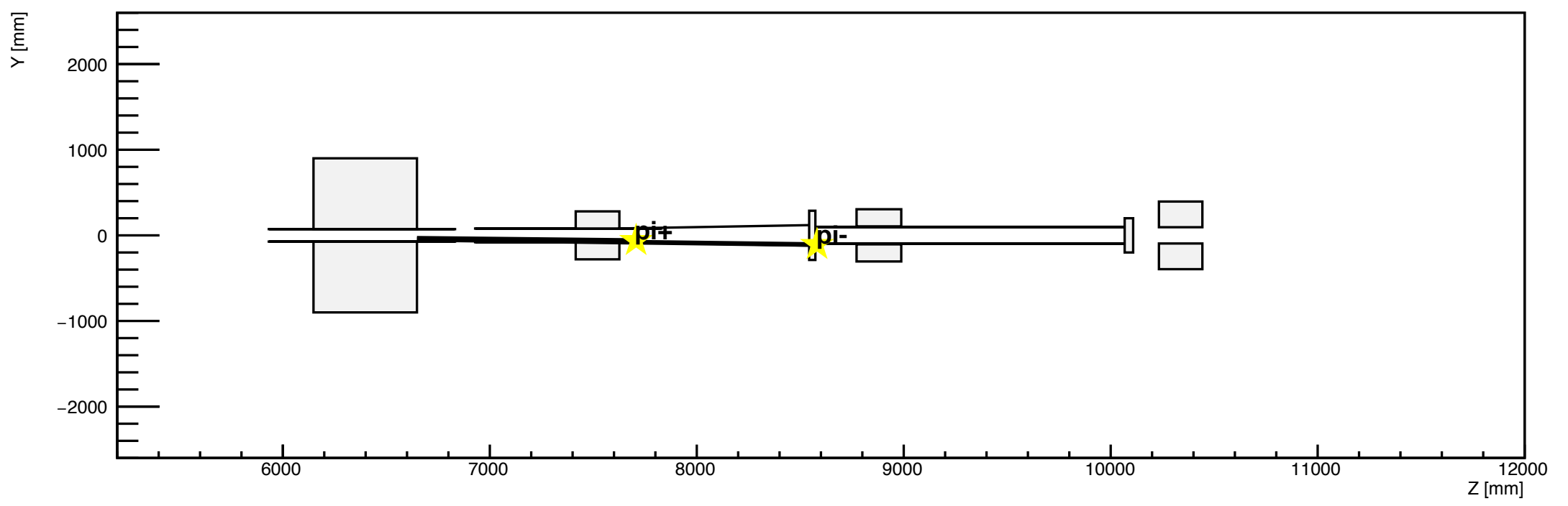

h2

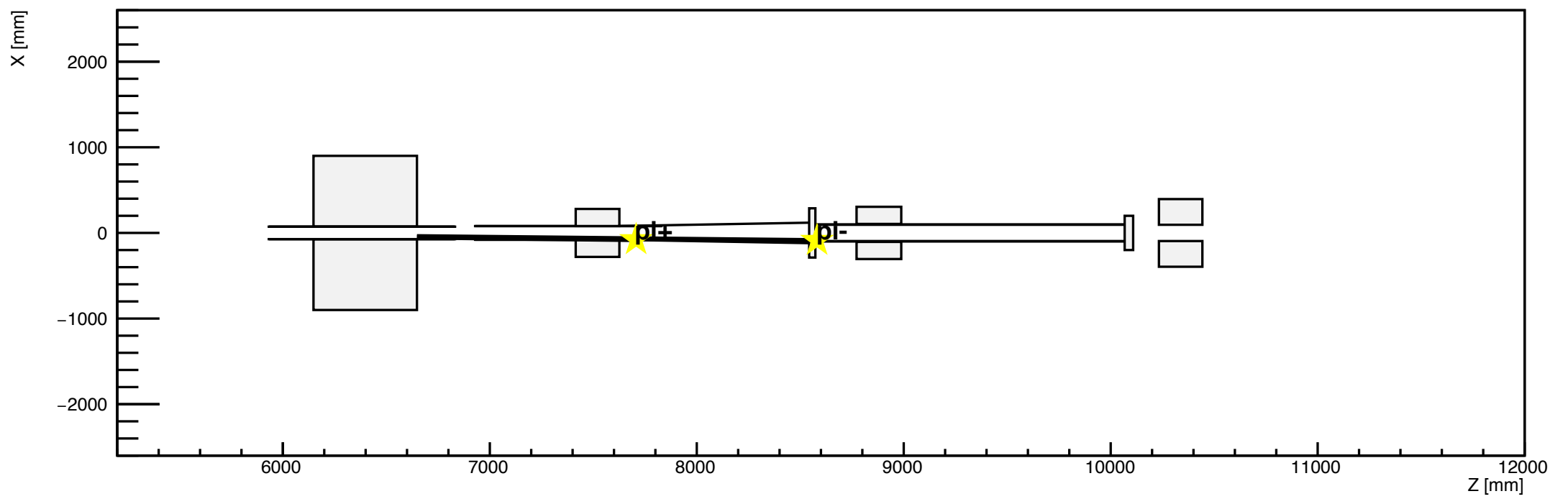

h1

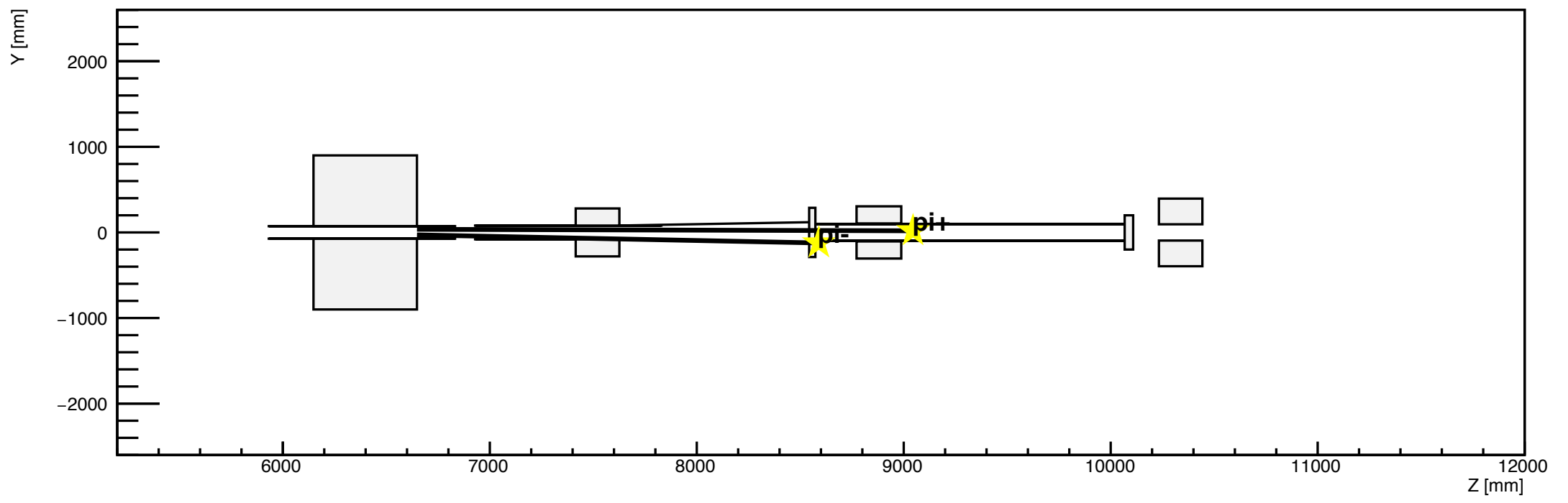

h2

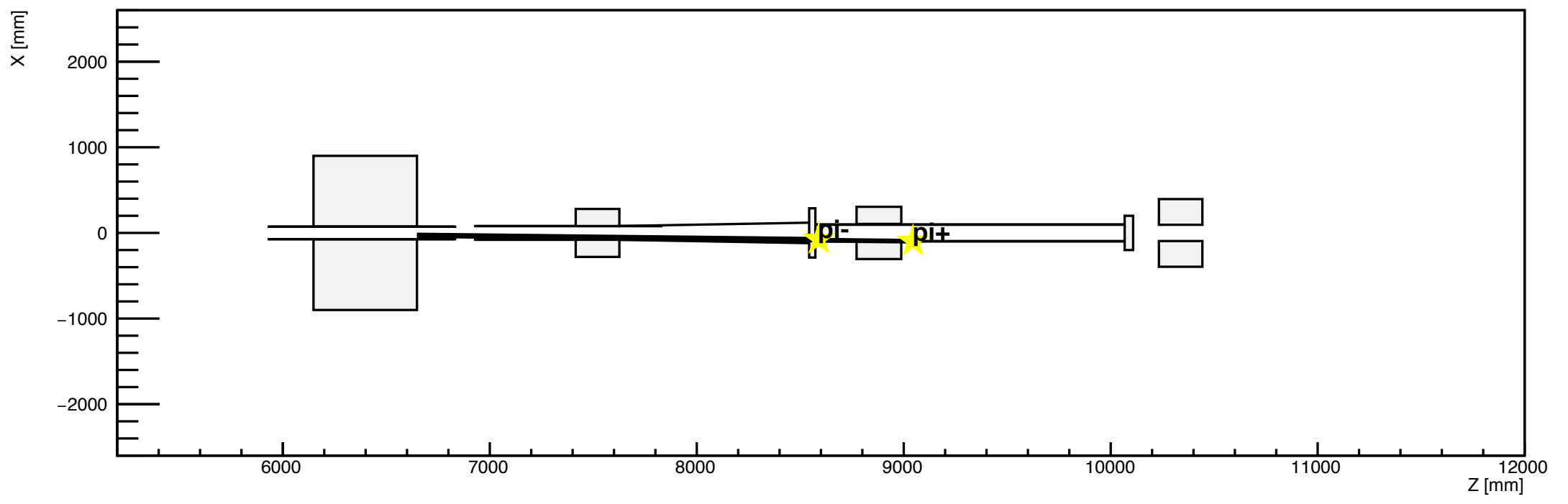

h1

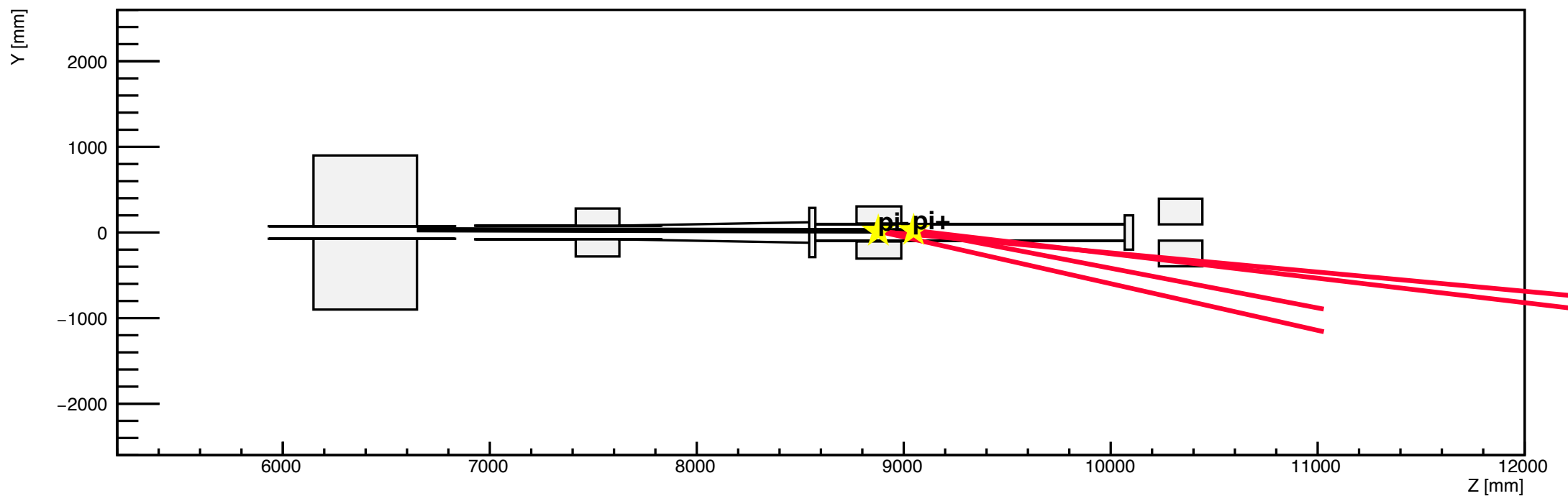

h2

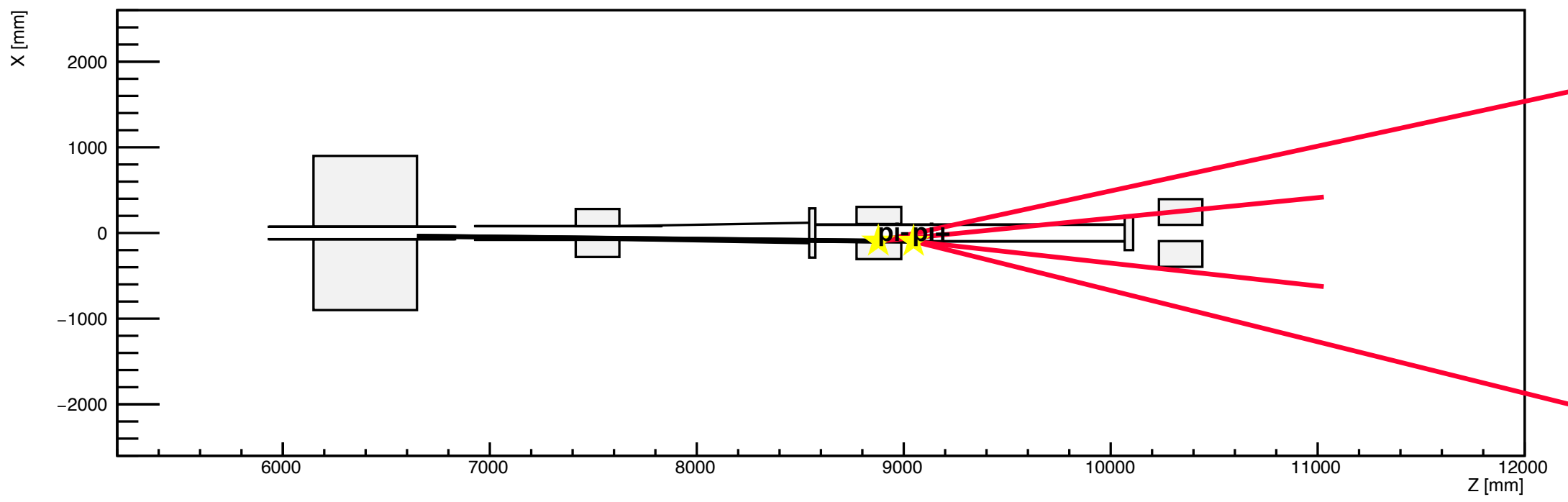

h1

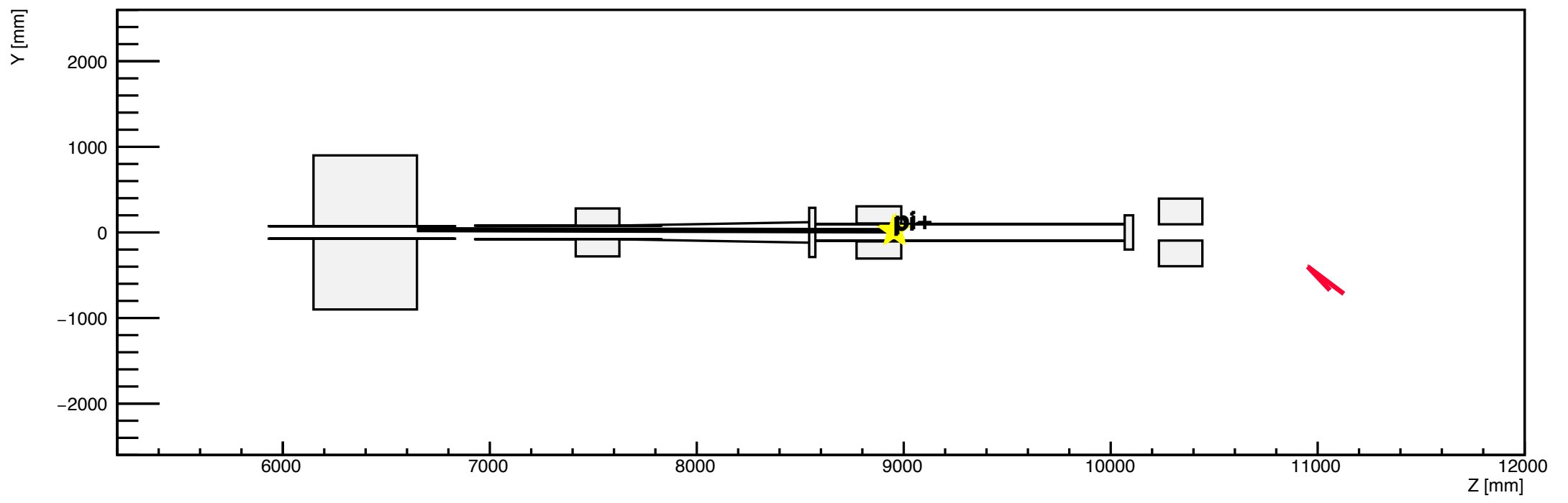

h2

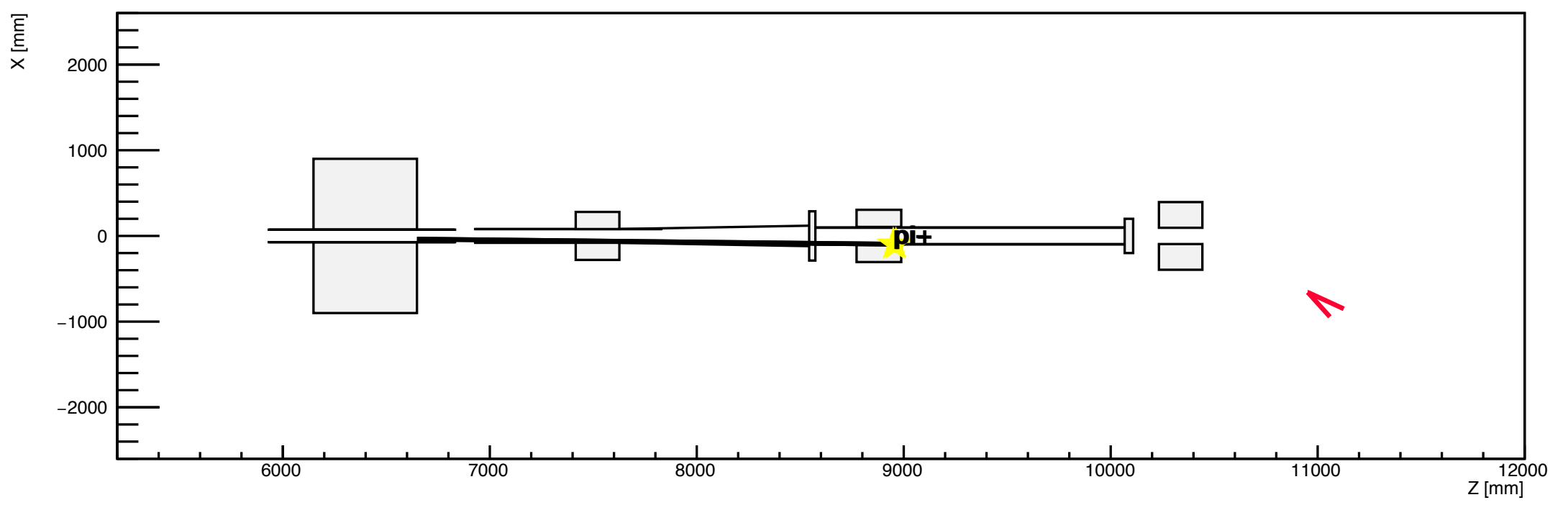

h1

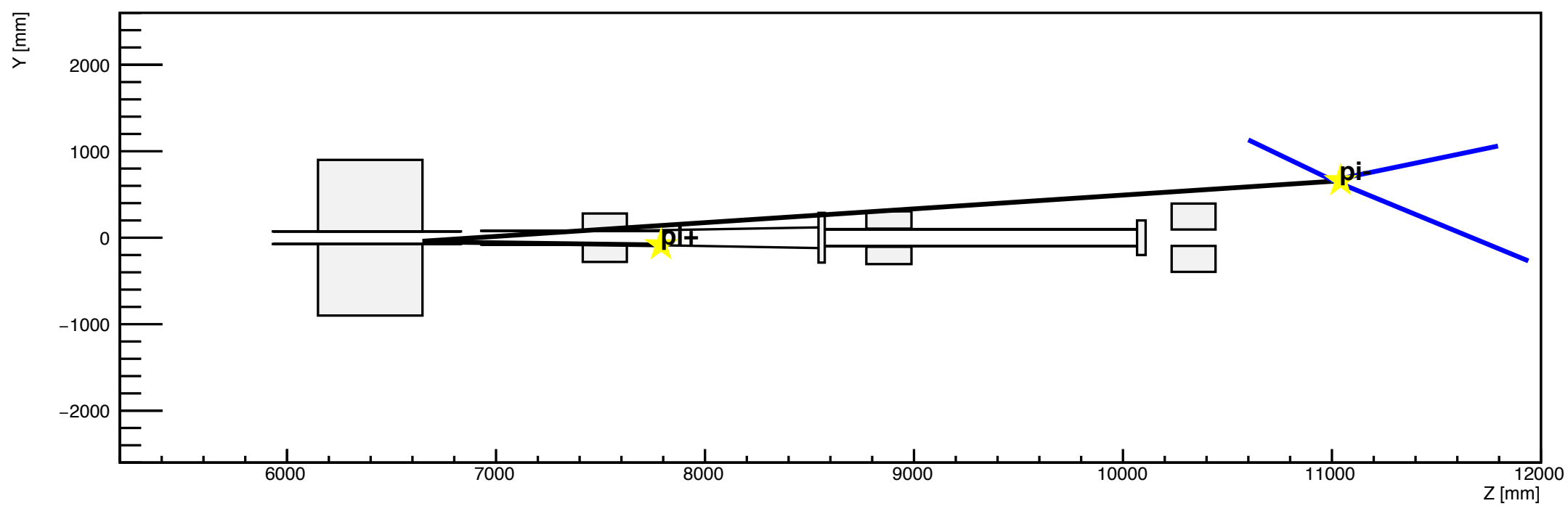

h2

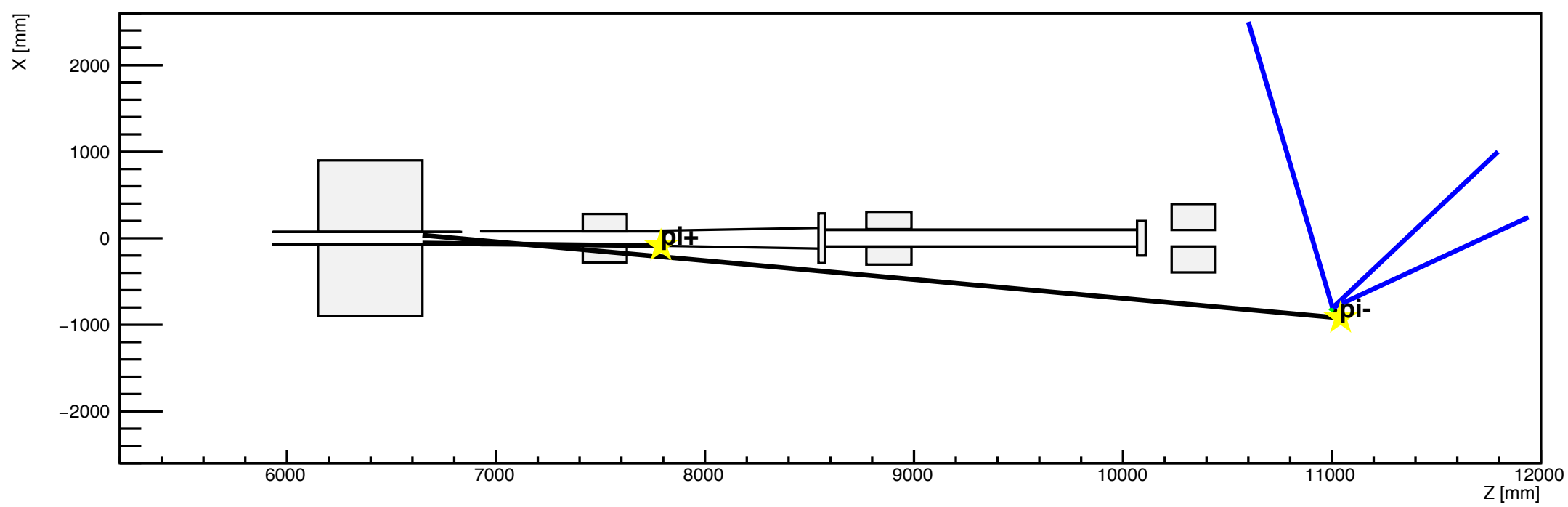

h1

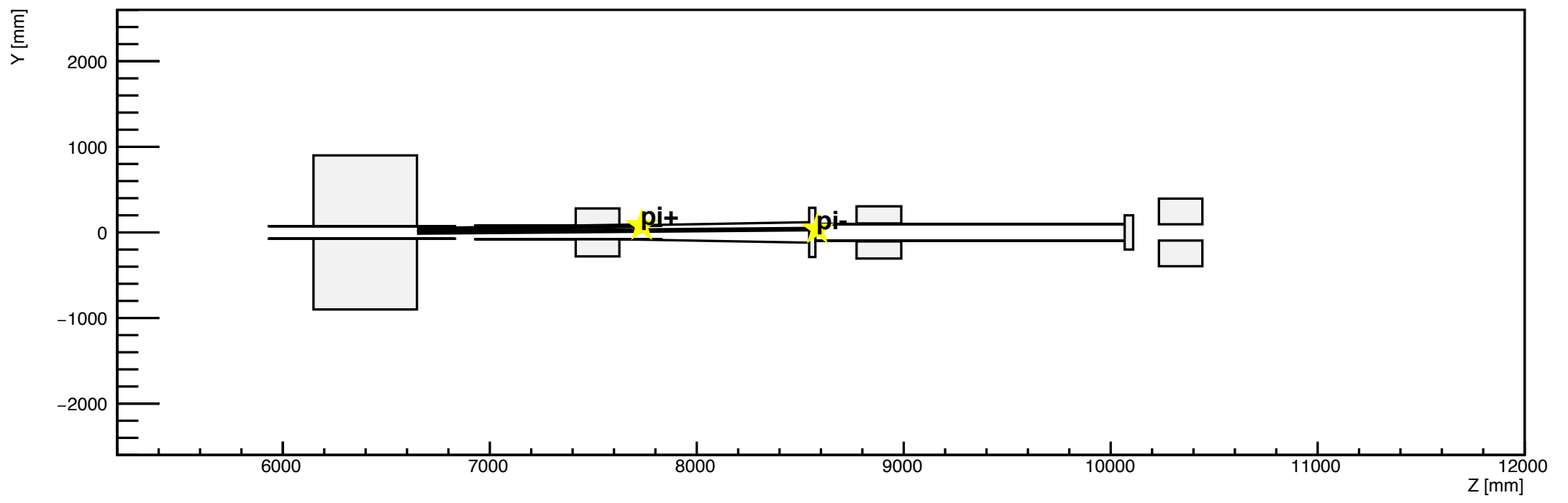

h2

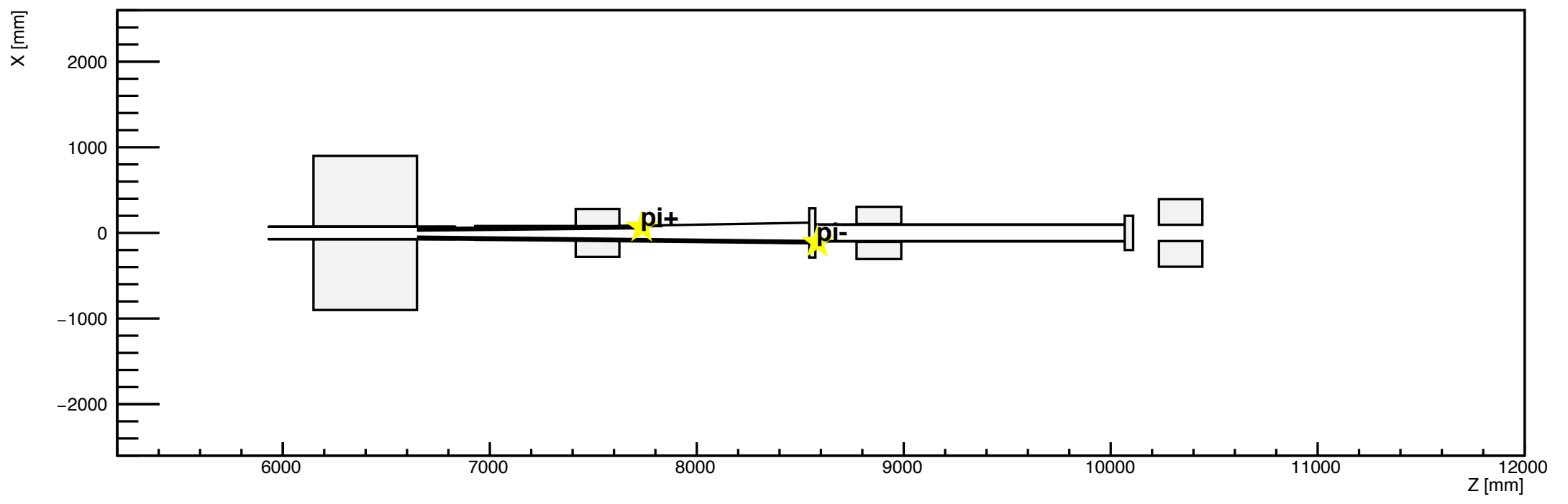

h1

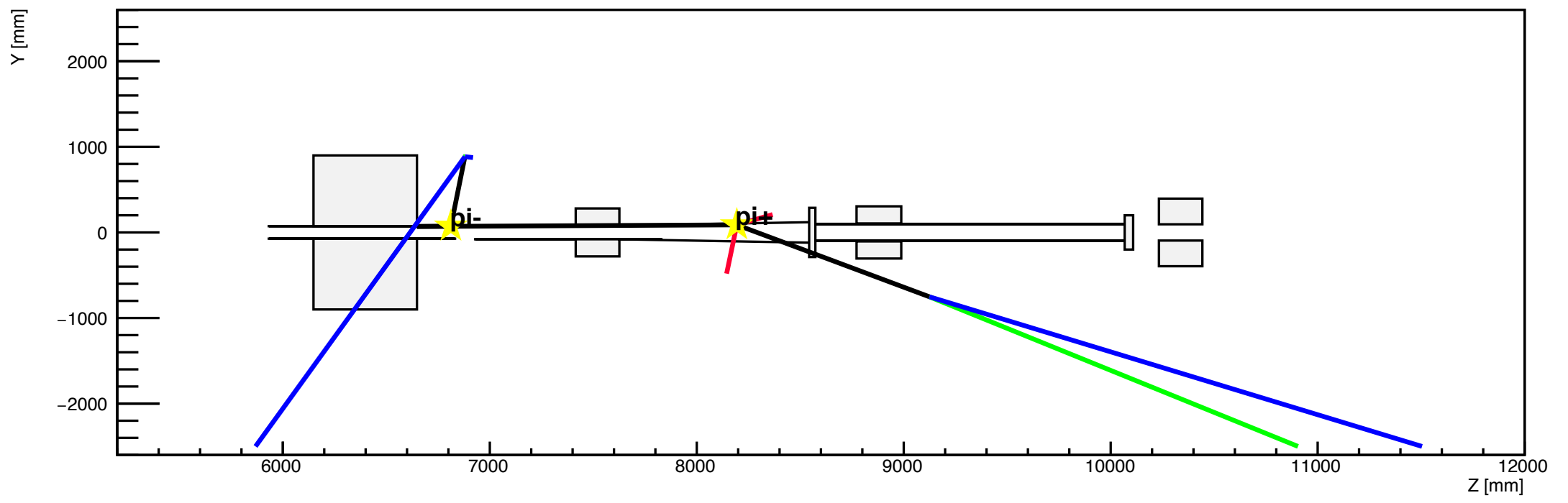

h2

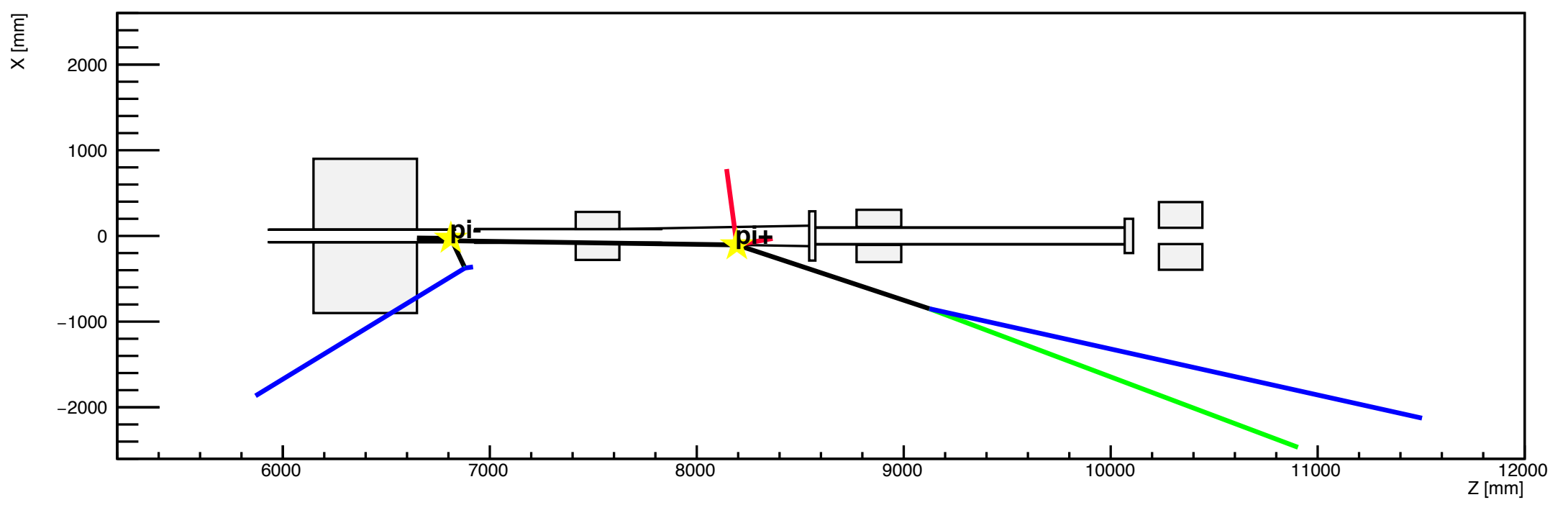

h1

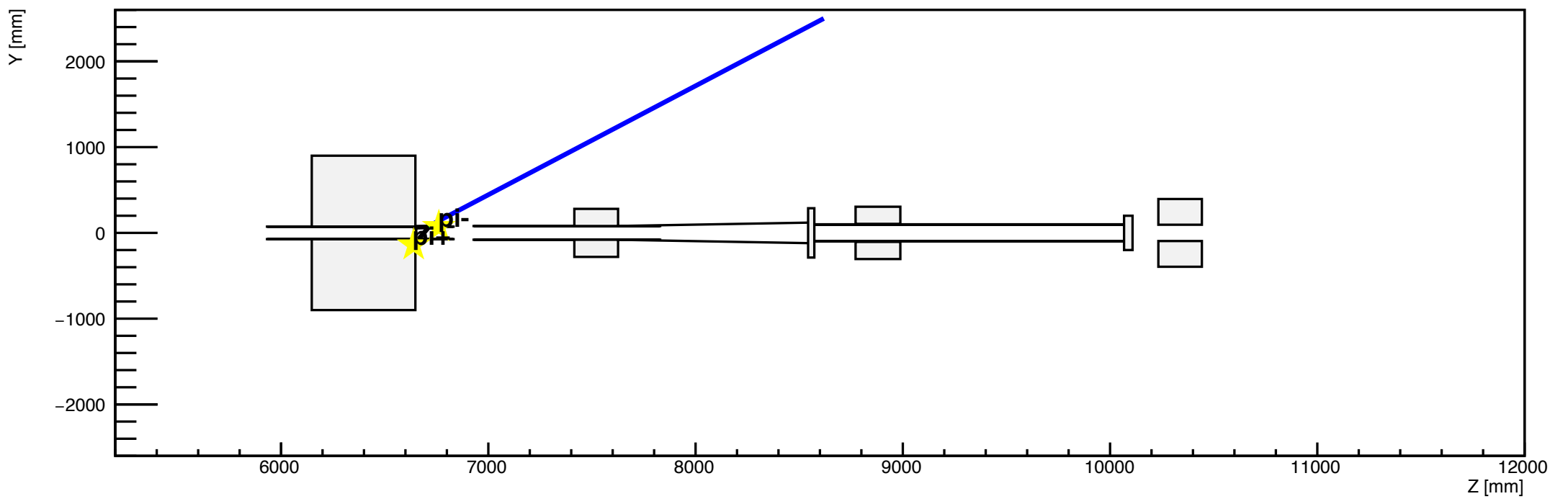

h2

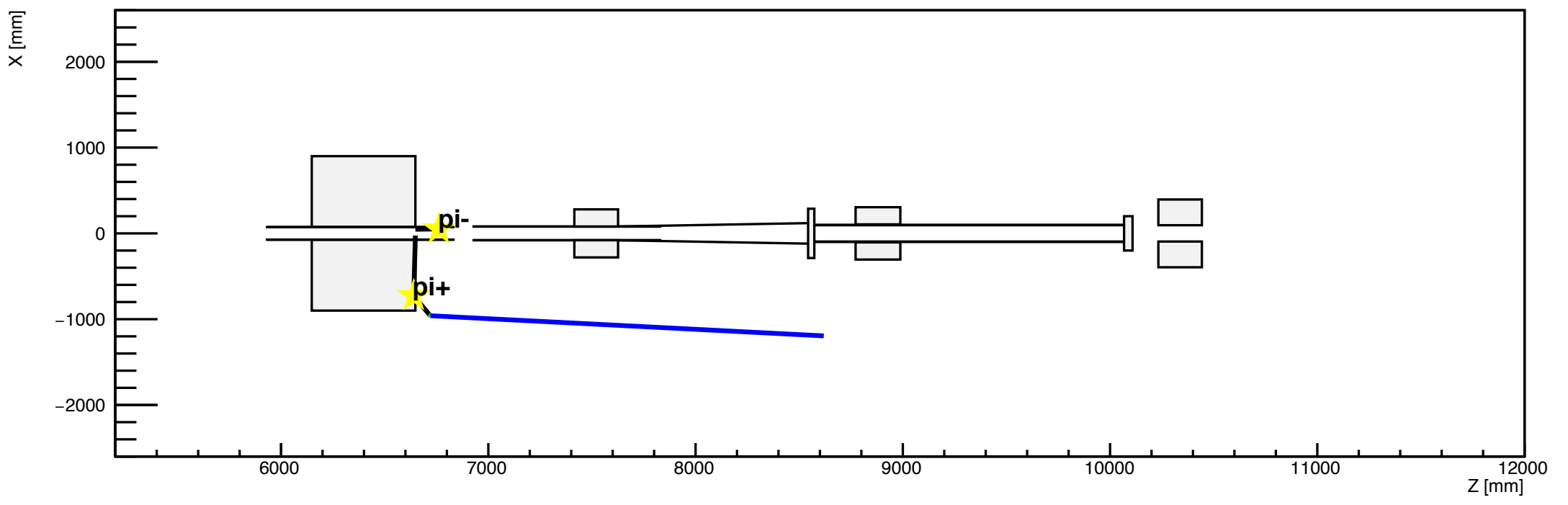

h1

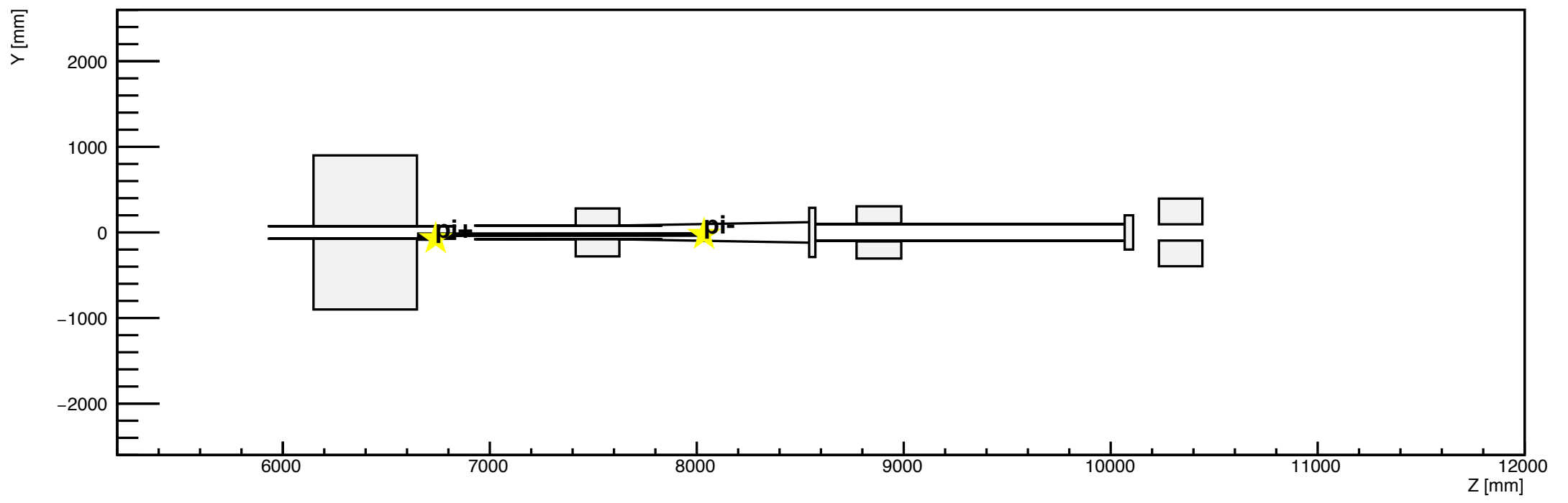

h2

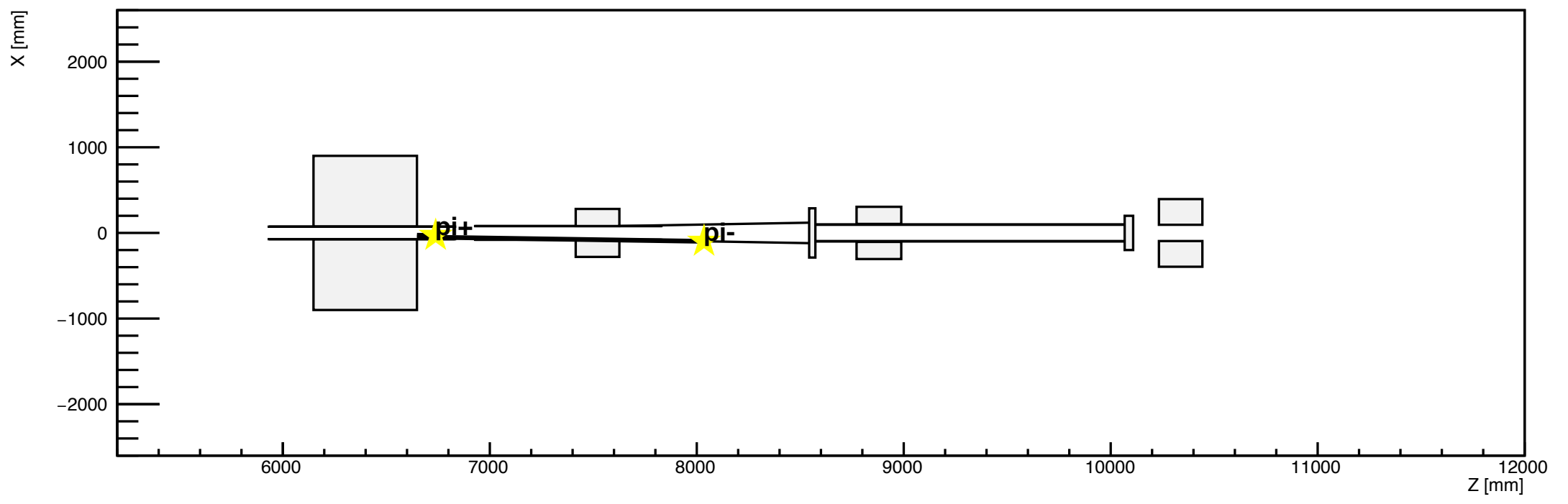

h1

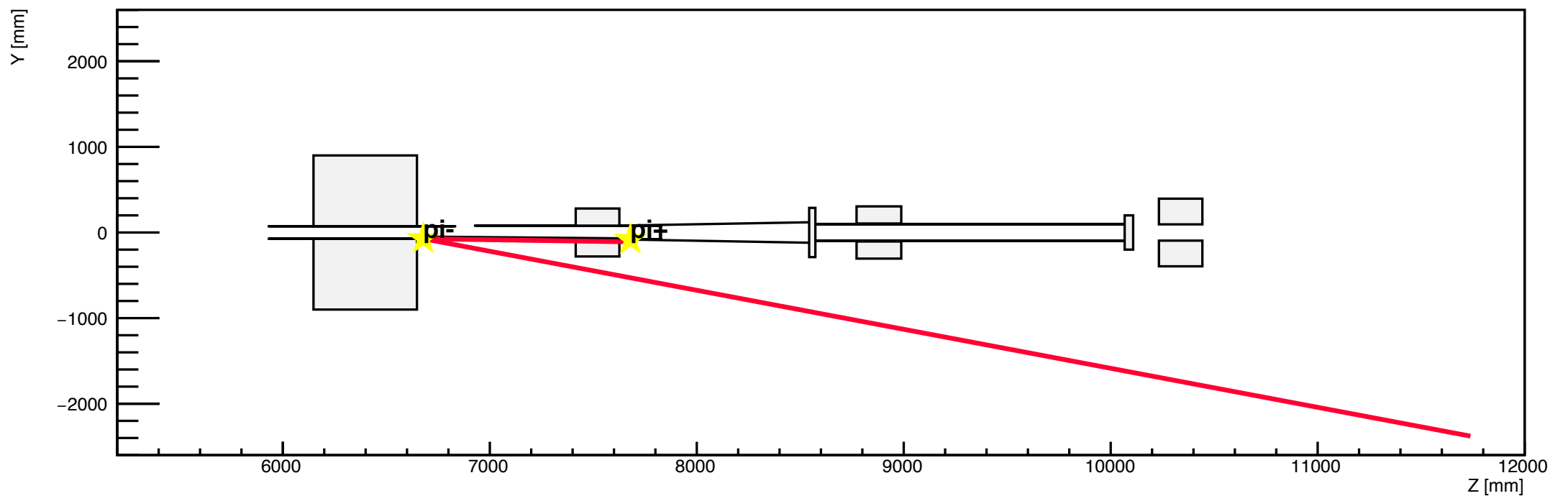

h2

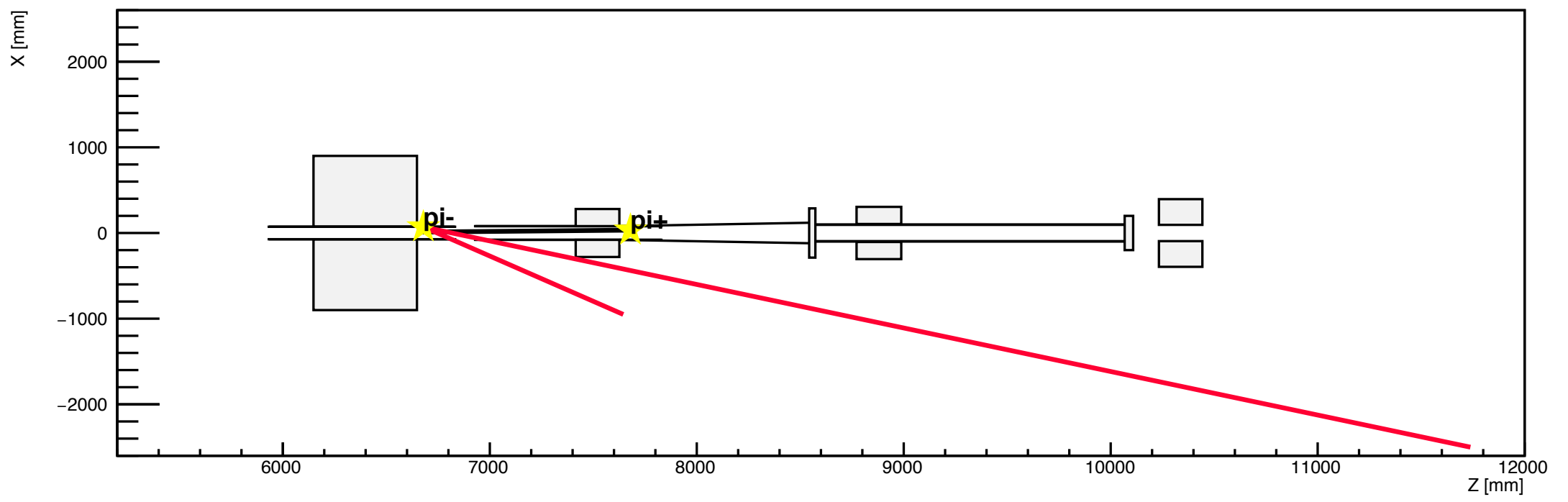

h1

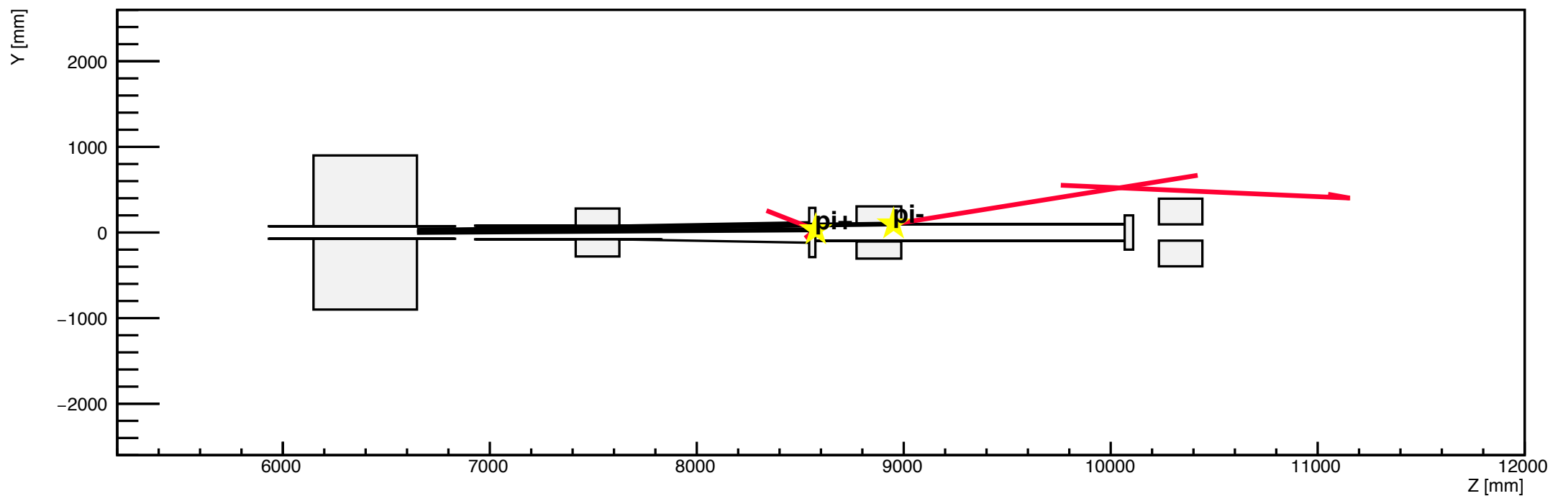

h2

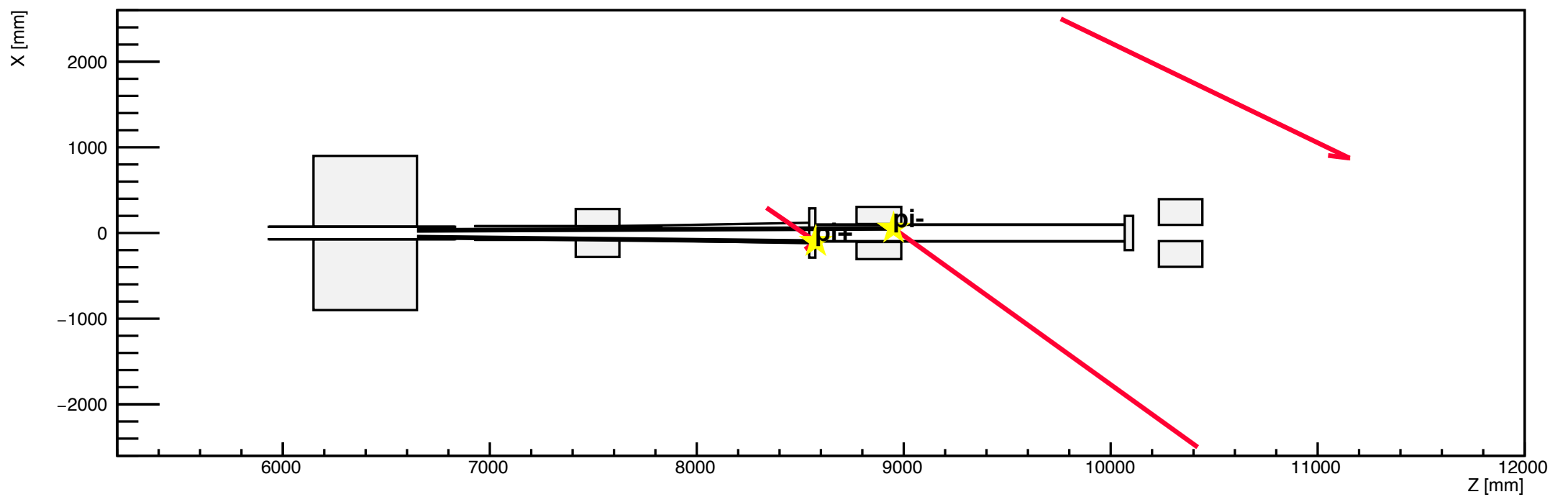

h1

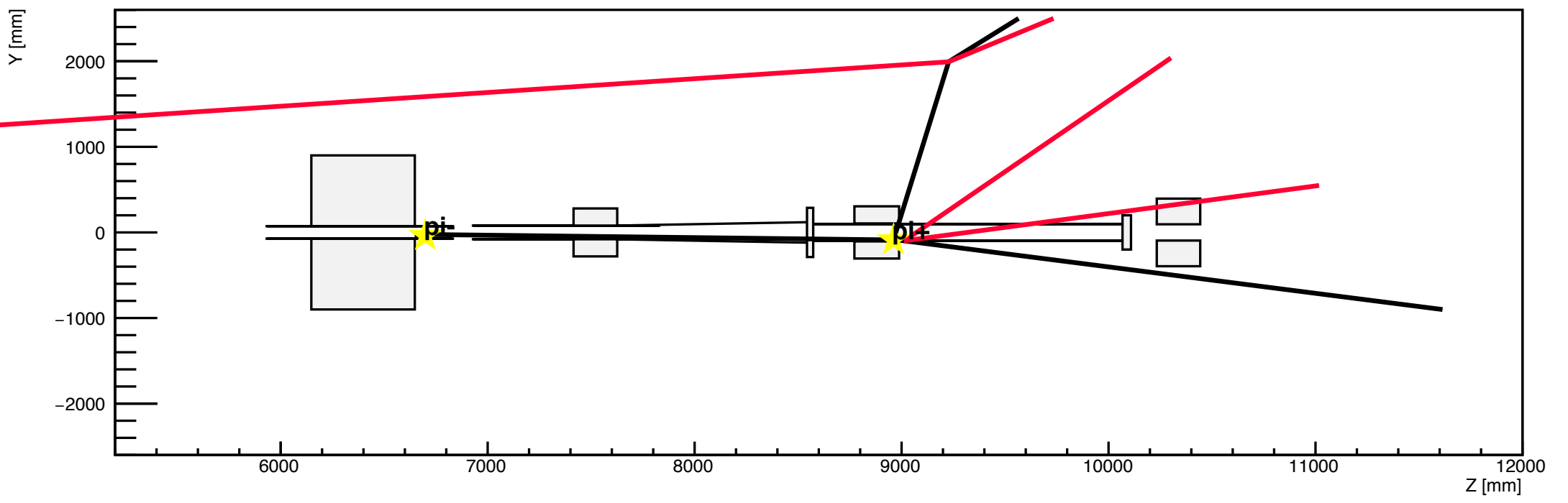

h2

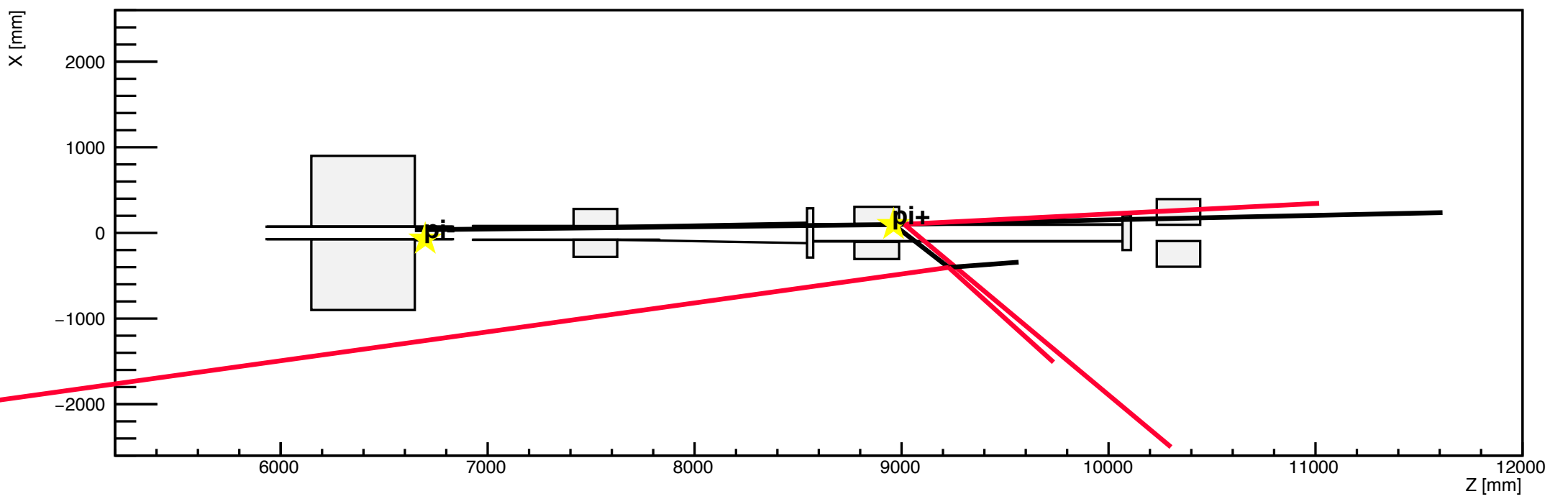

h1

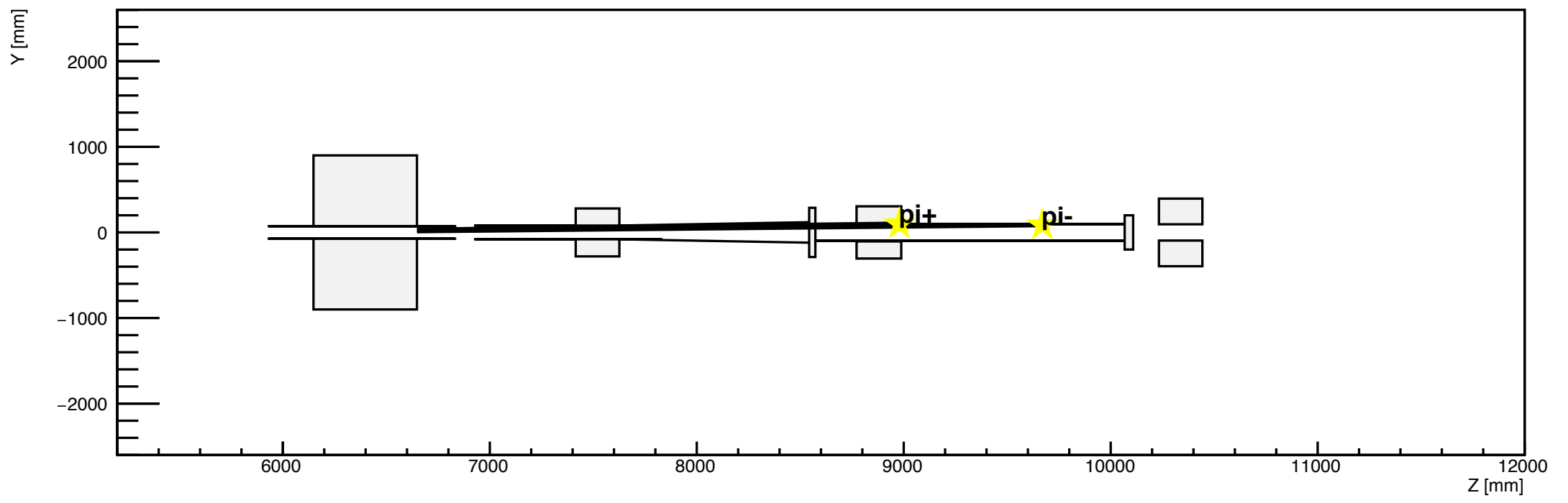

h2

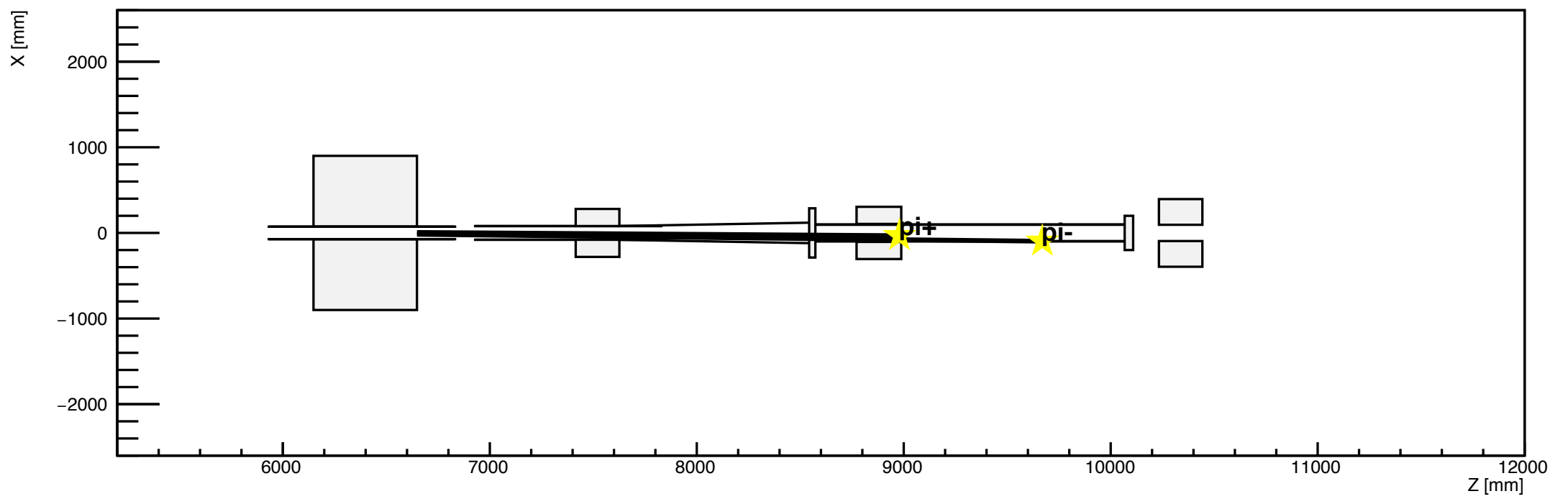

h1

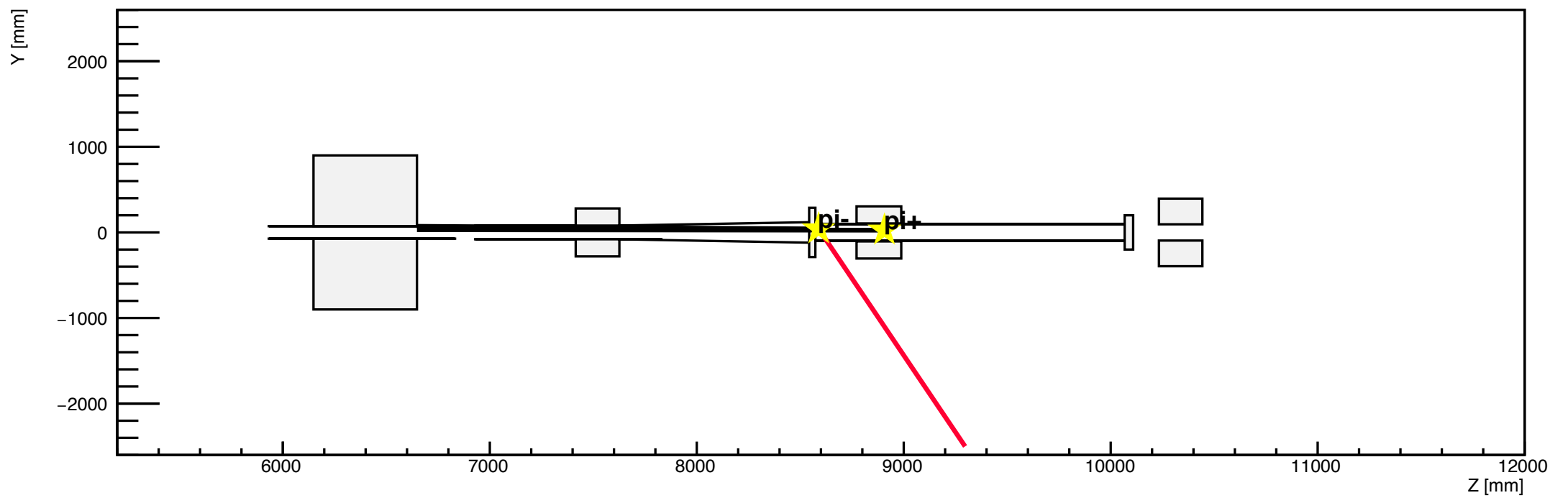

h2

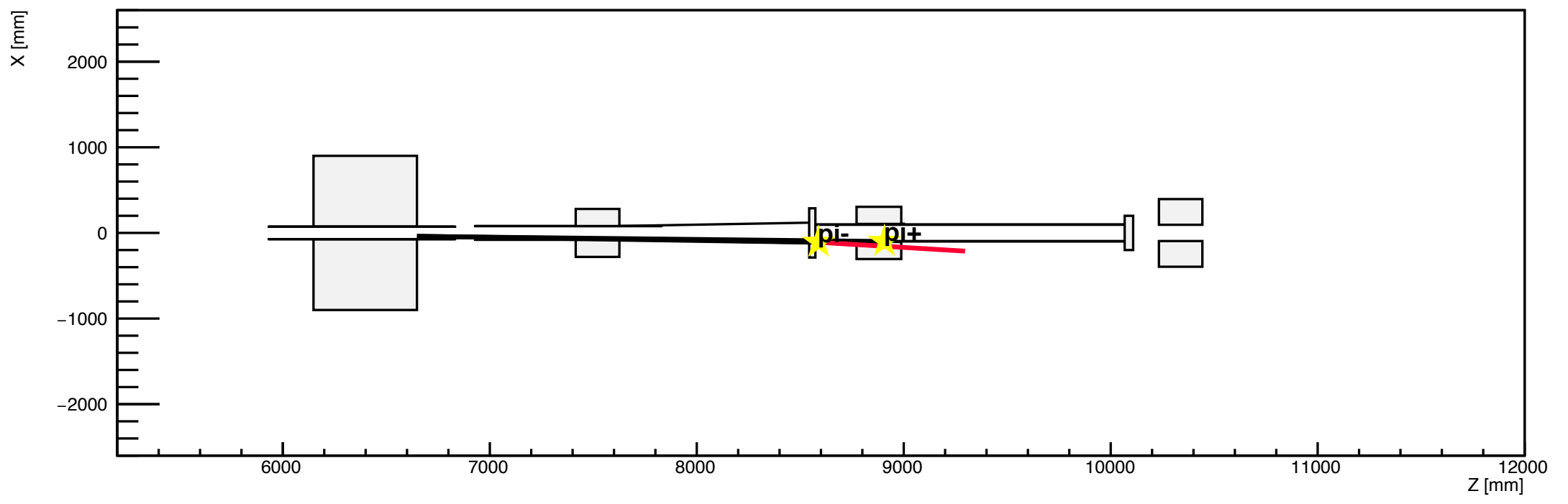

h1

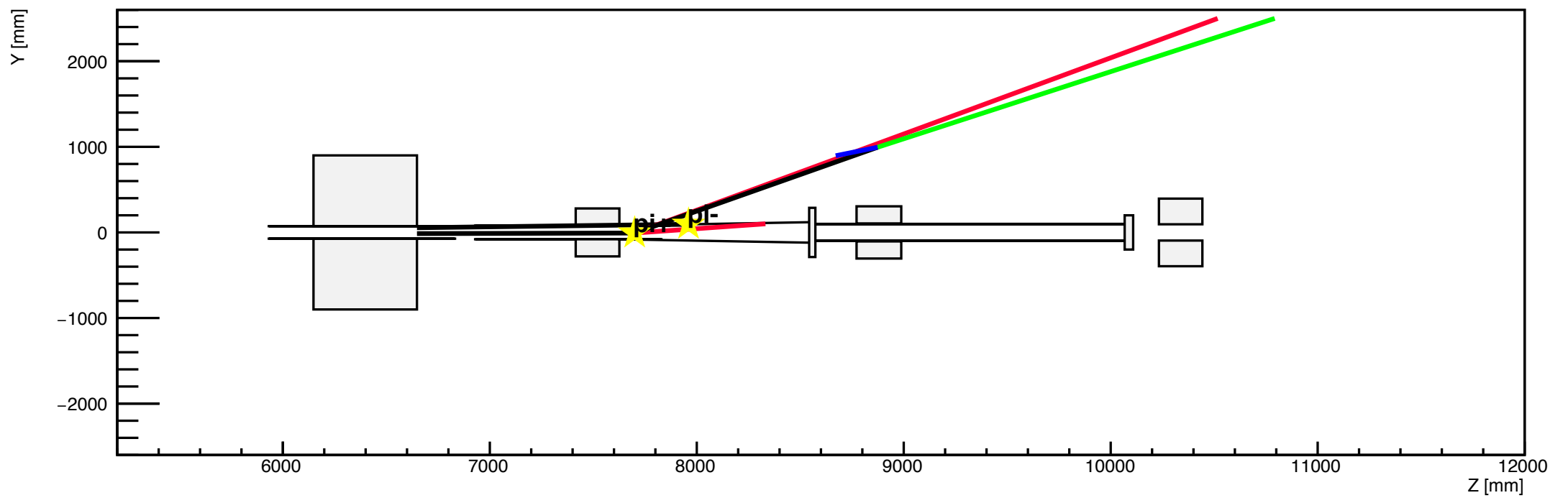

h2

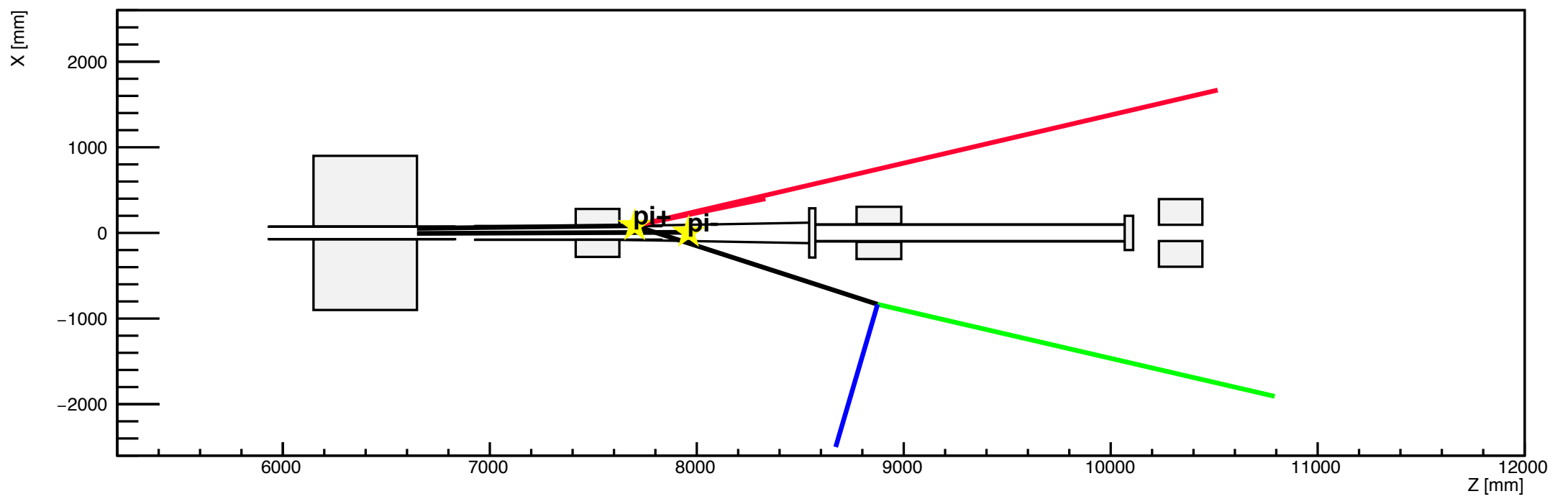

h1

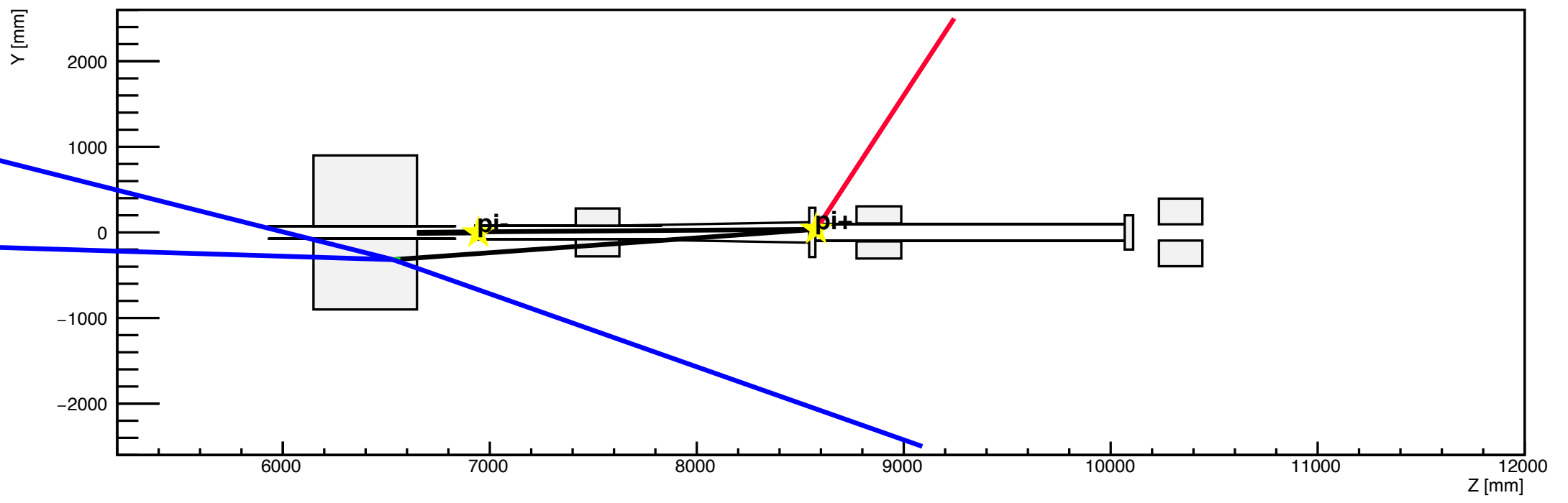

h2

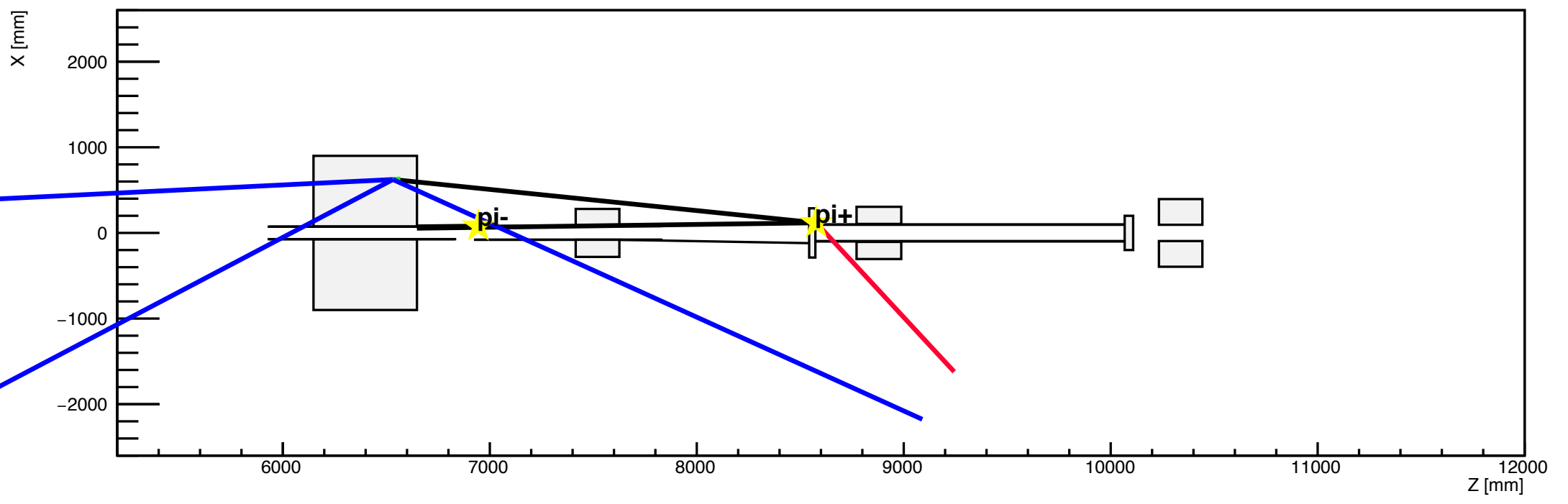

h1

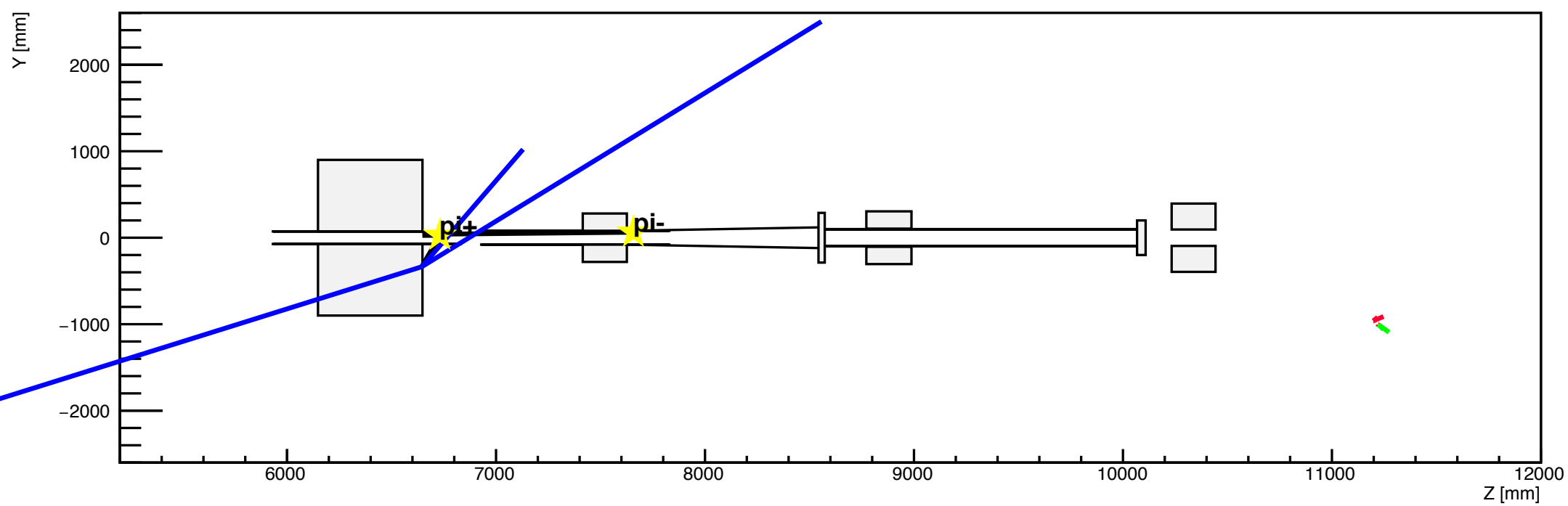

h2

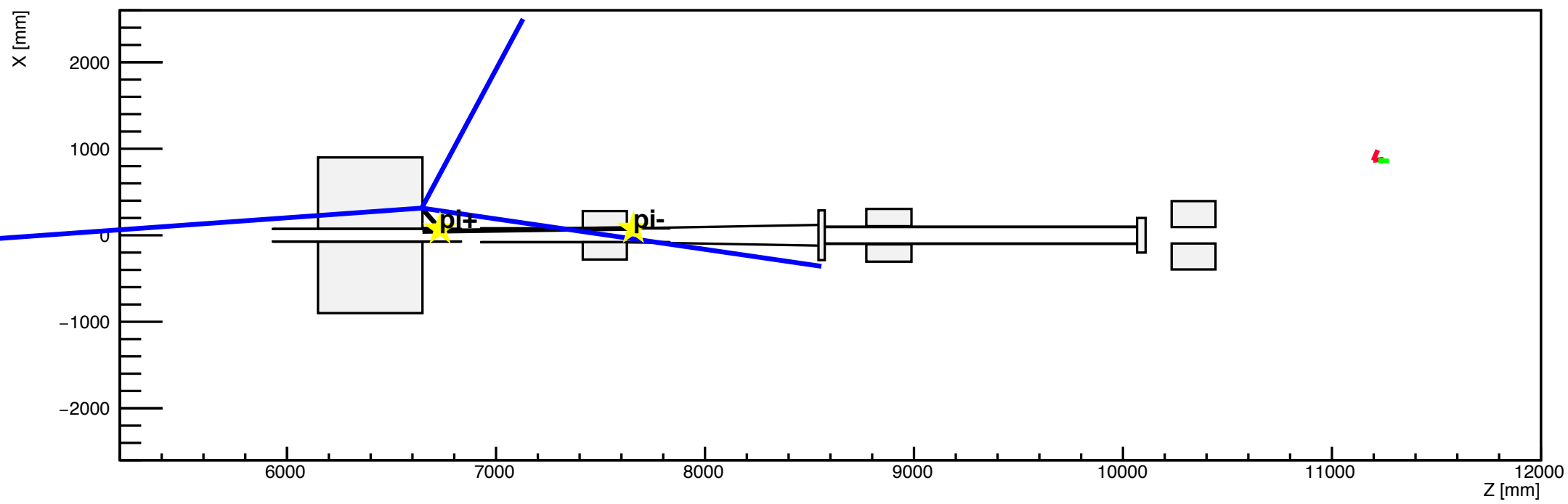

h1

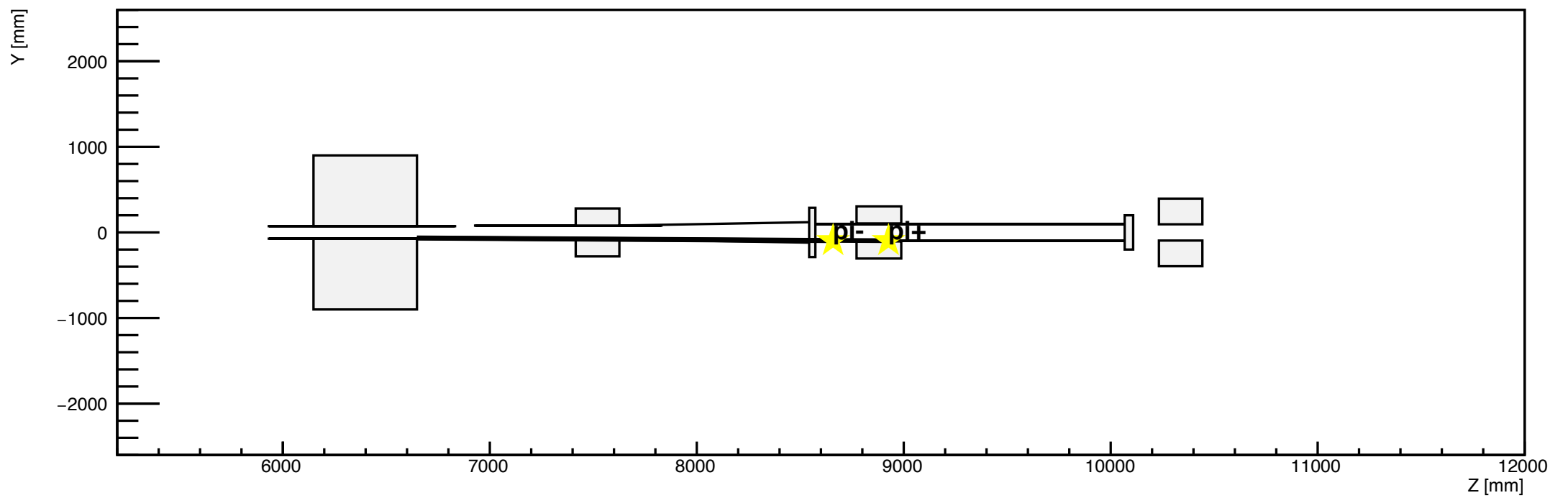

h2

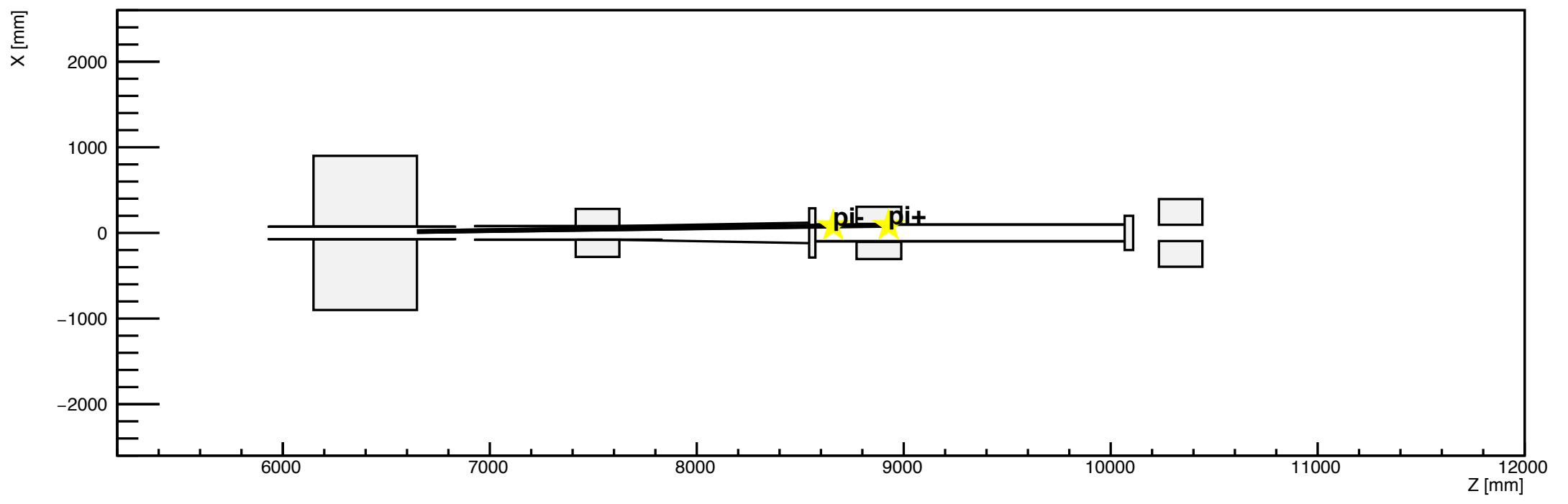

h1

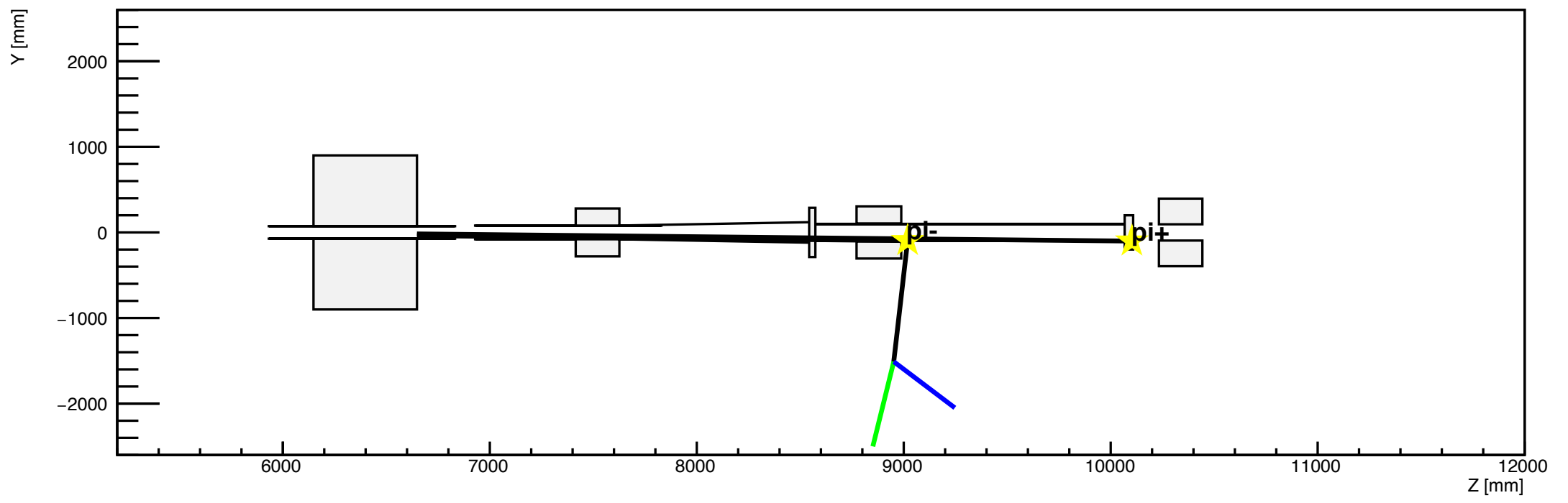

h2

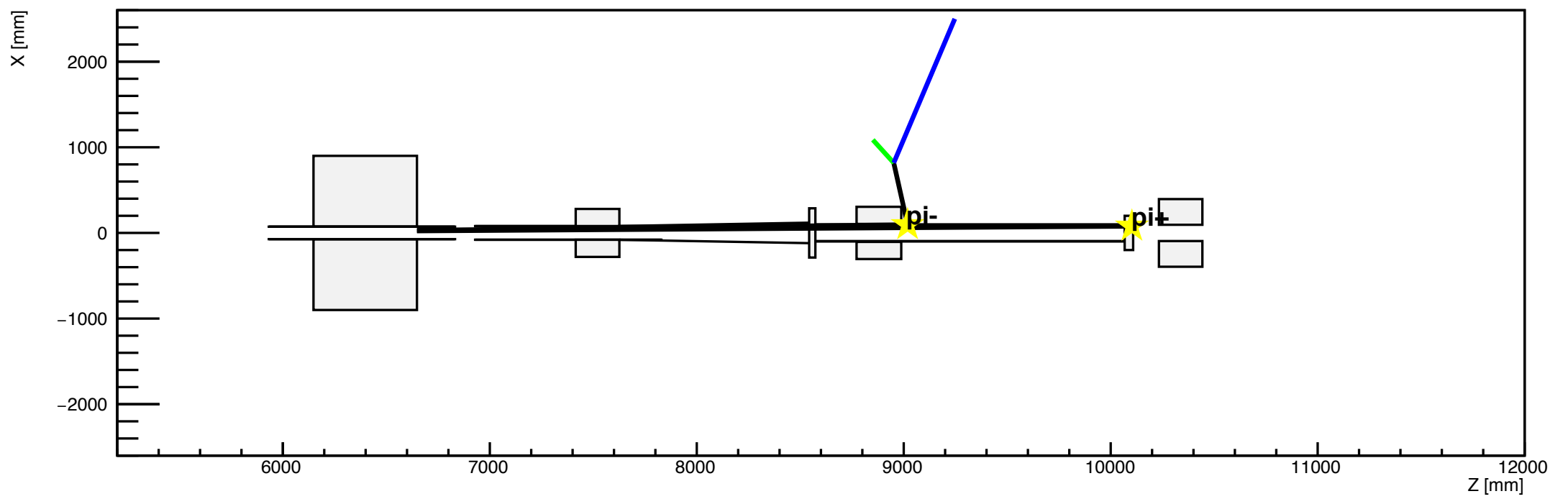

h1

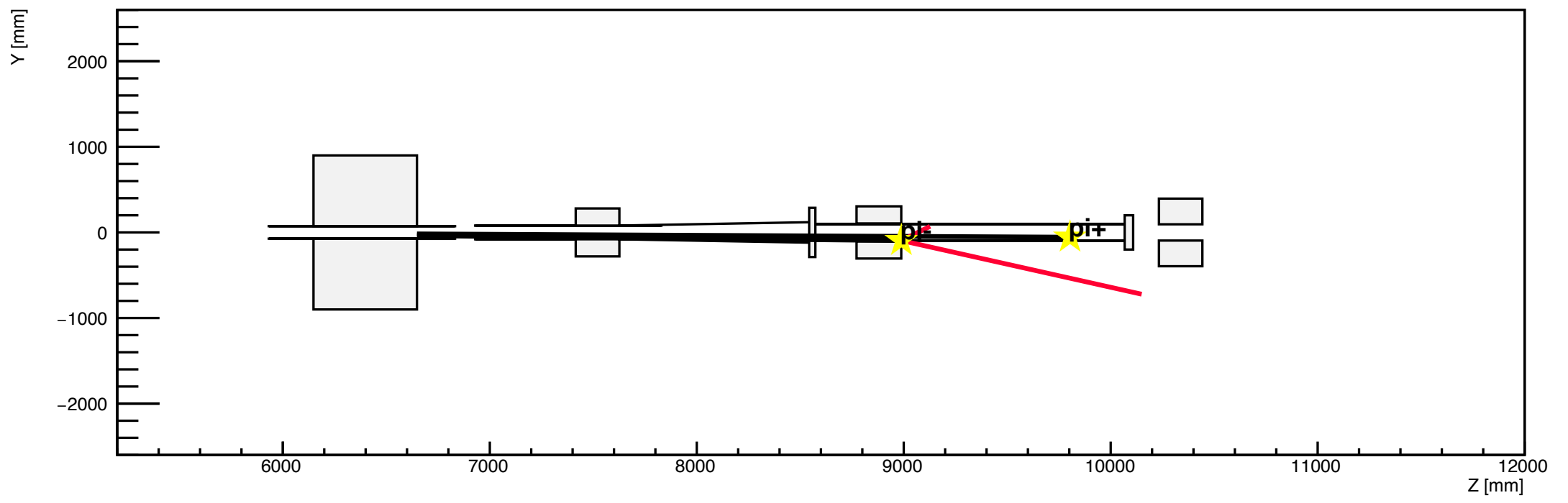

h2

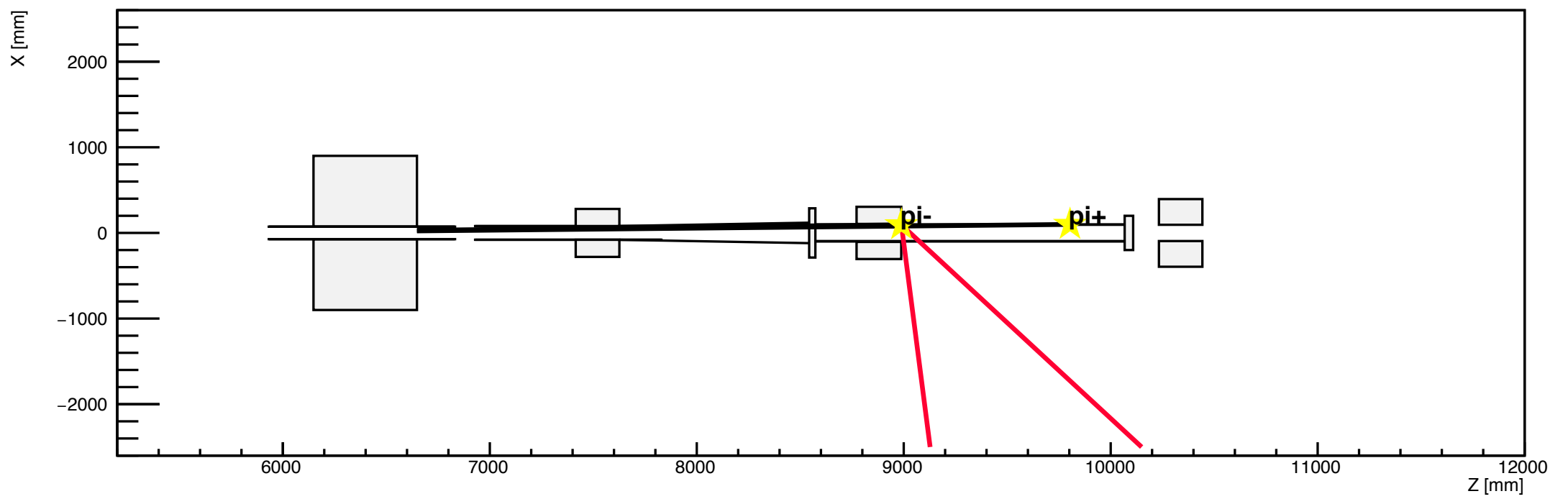

h1

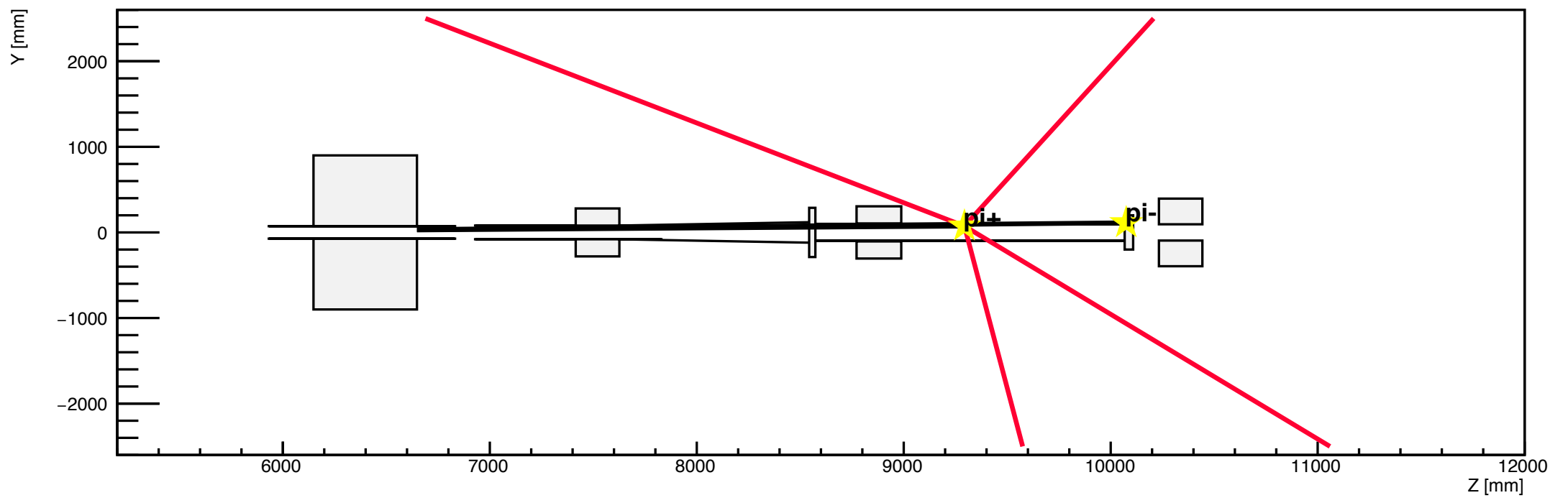

h2

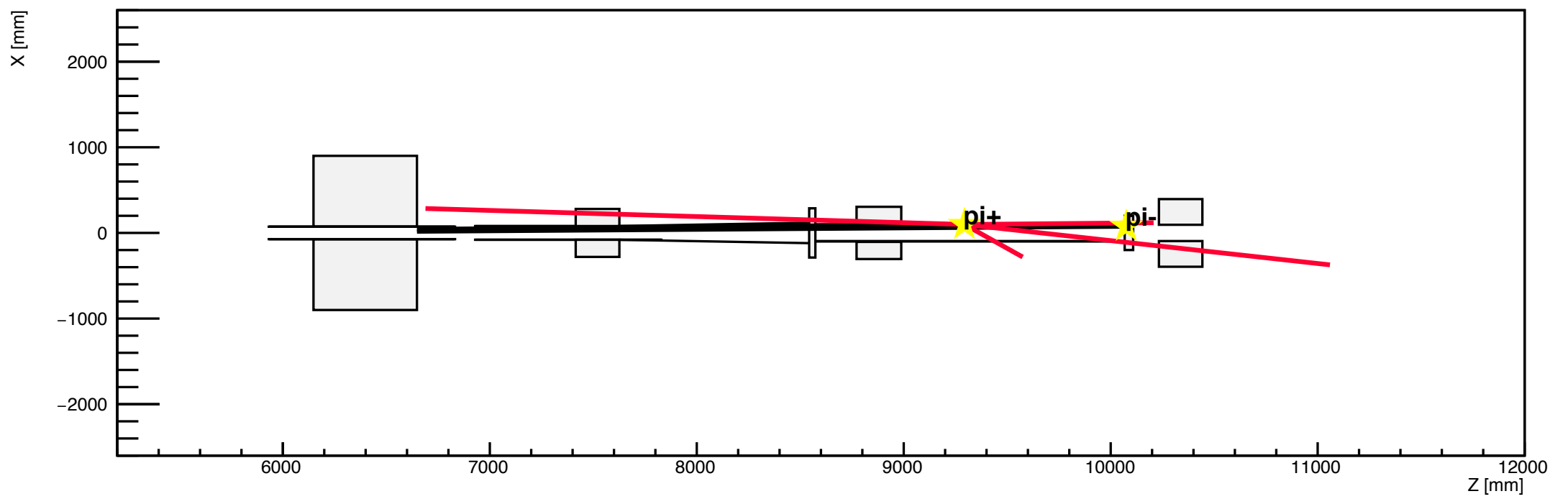

h1

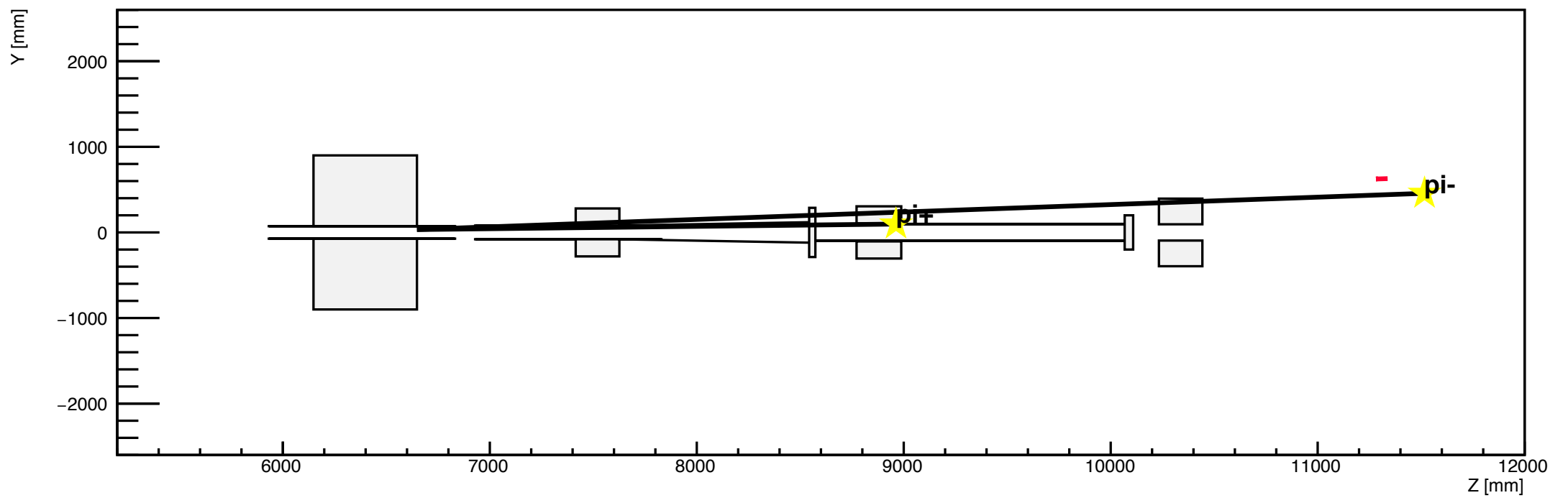

h2

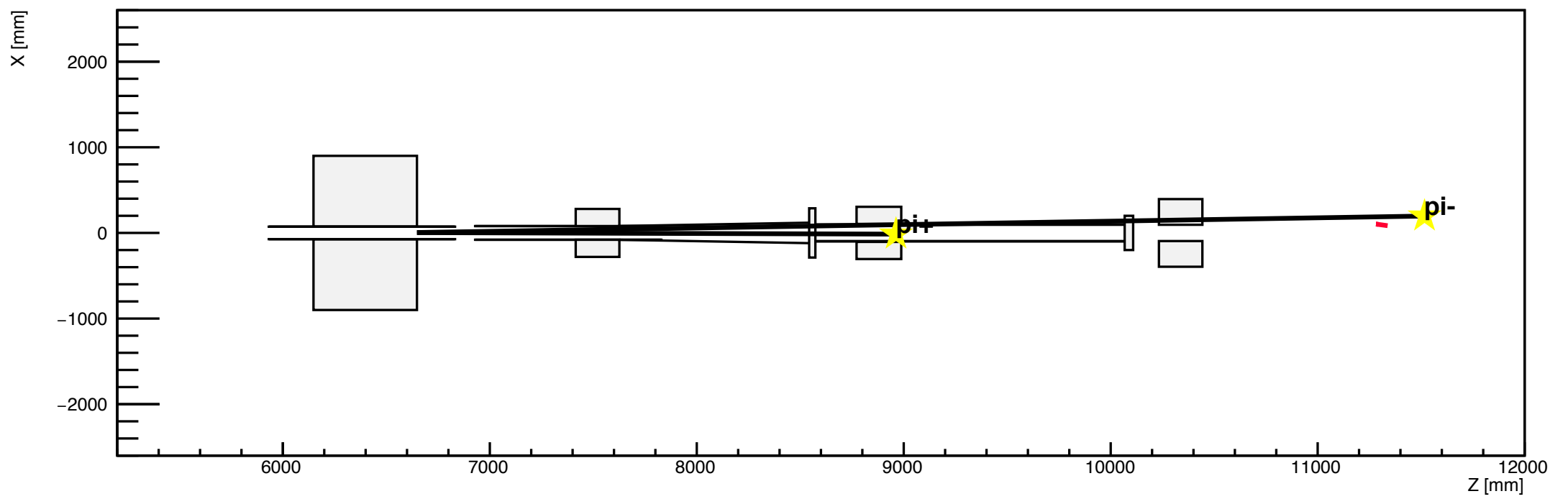

h1

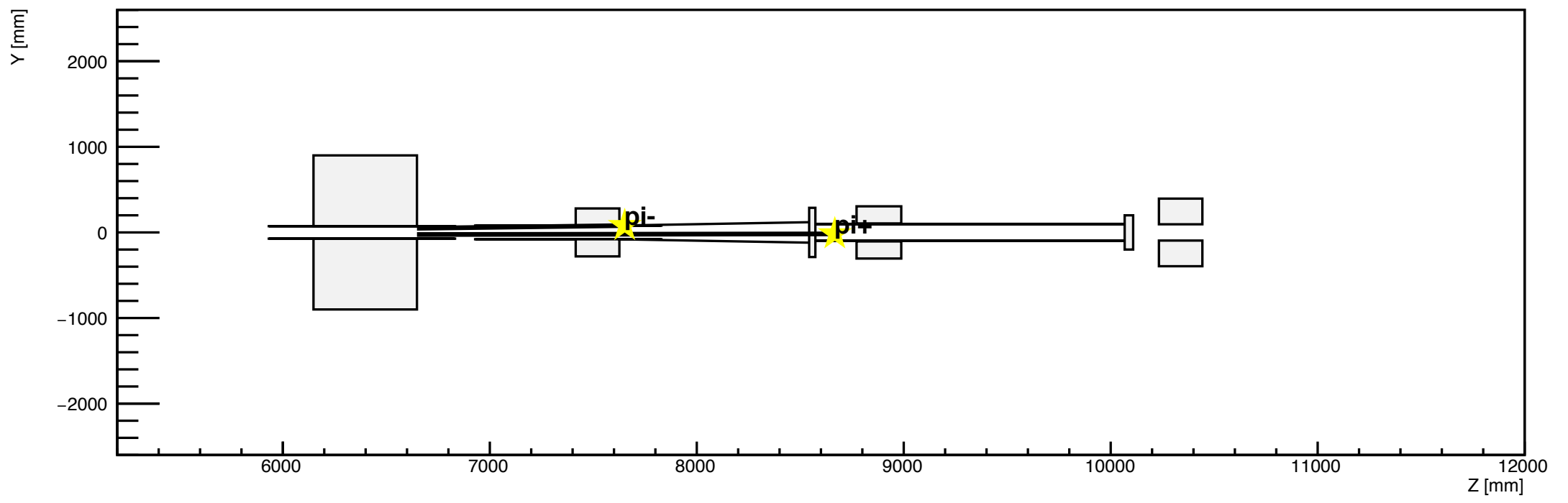

h2

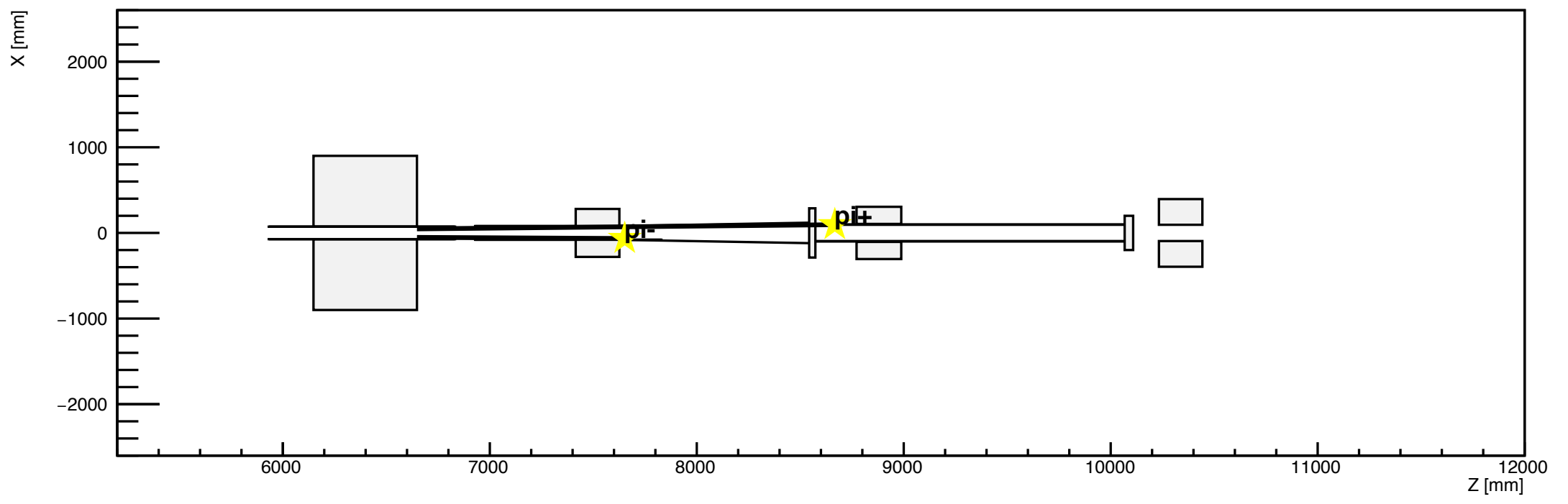

h1

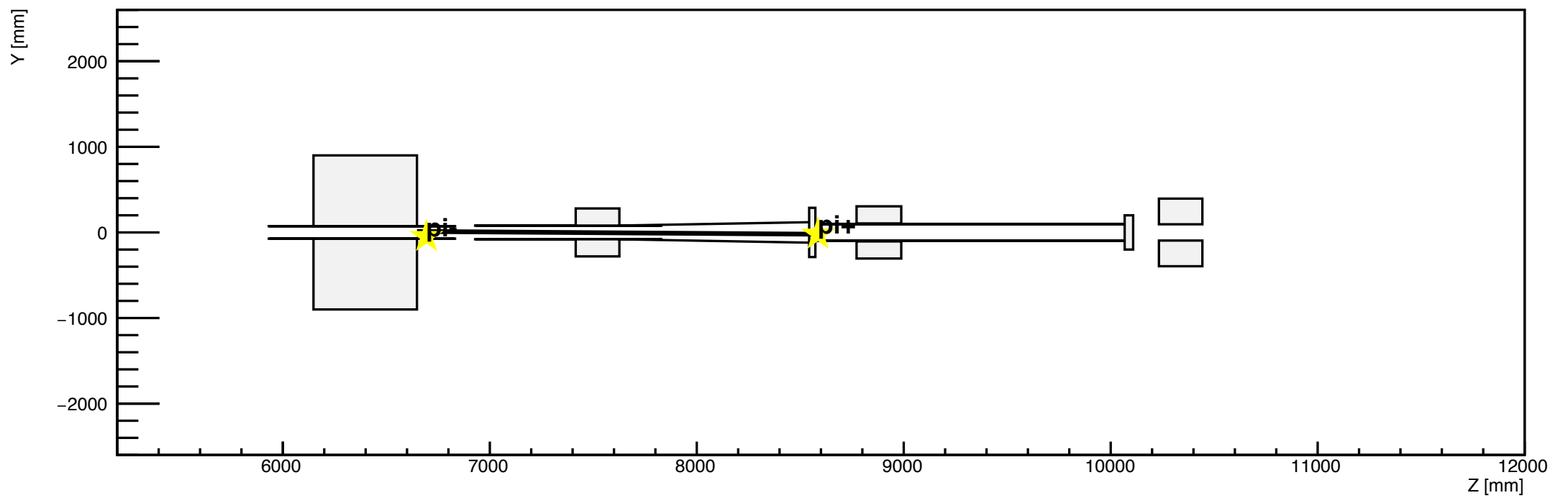

h2

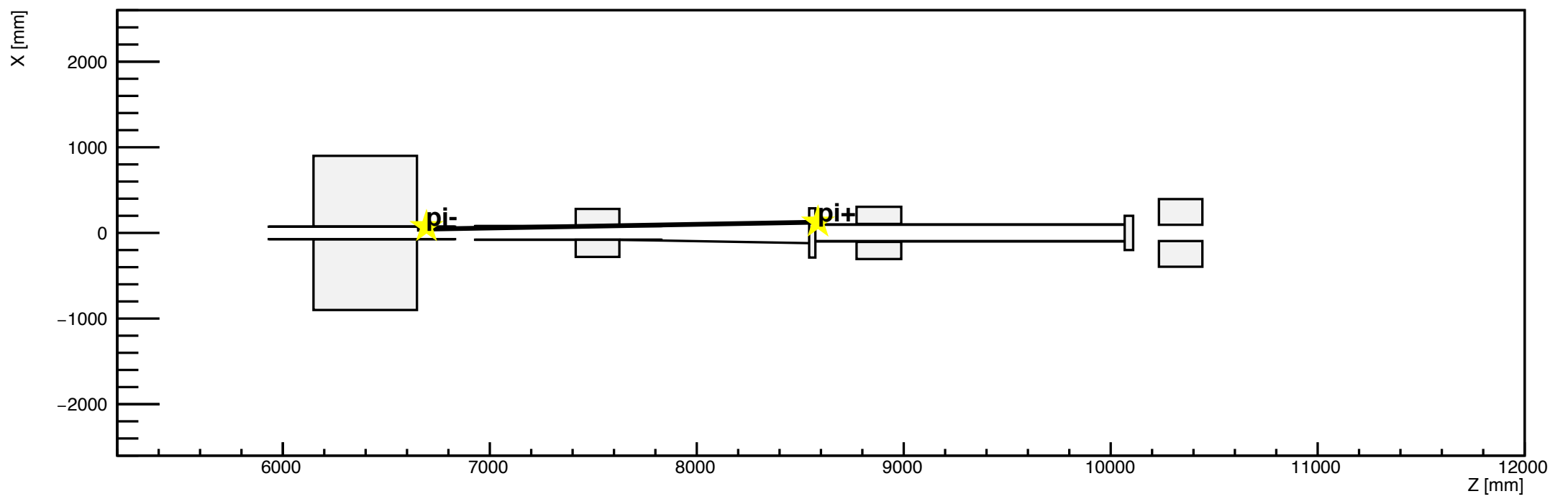

h1

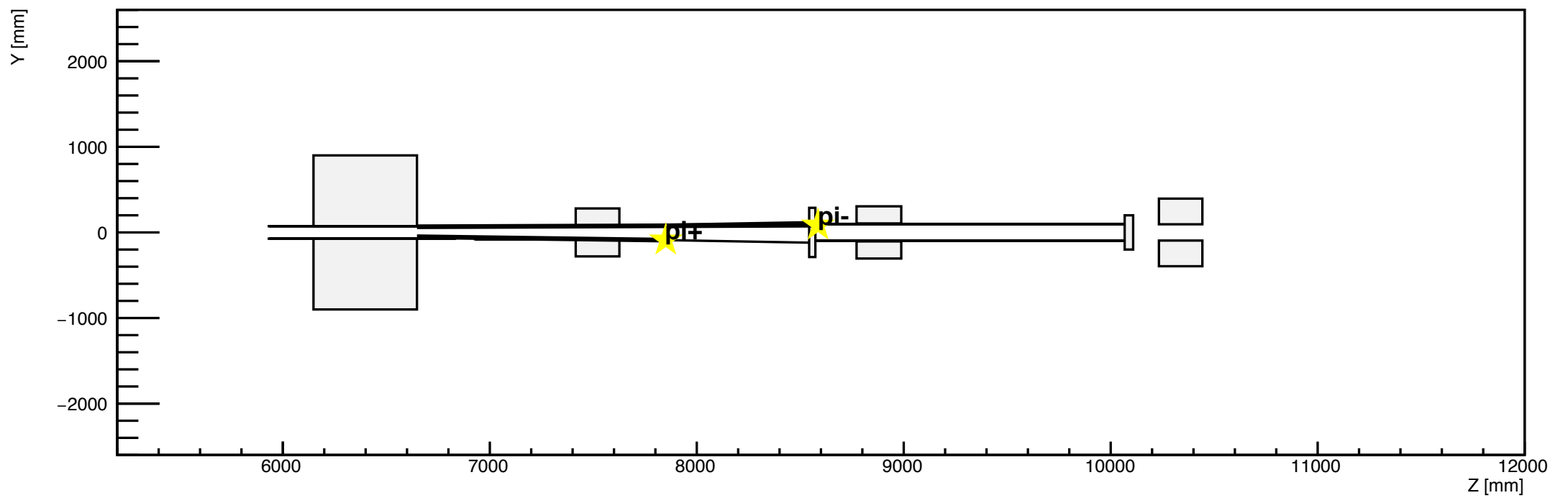

h2

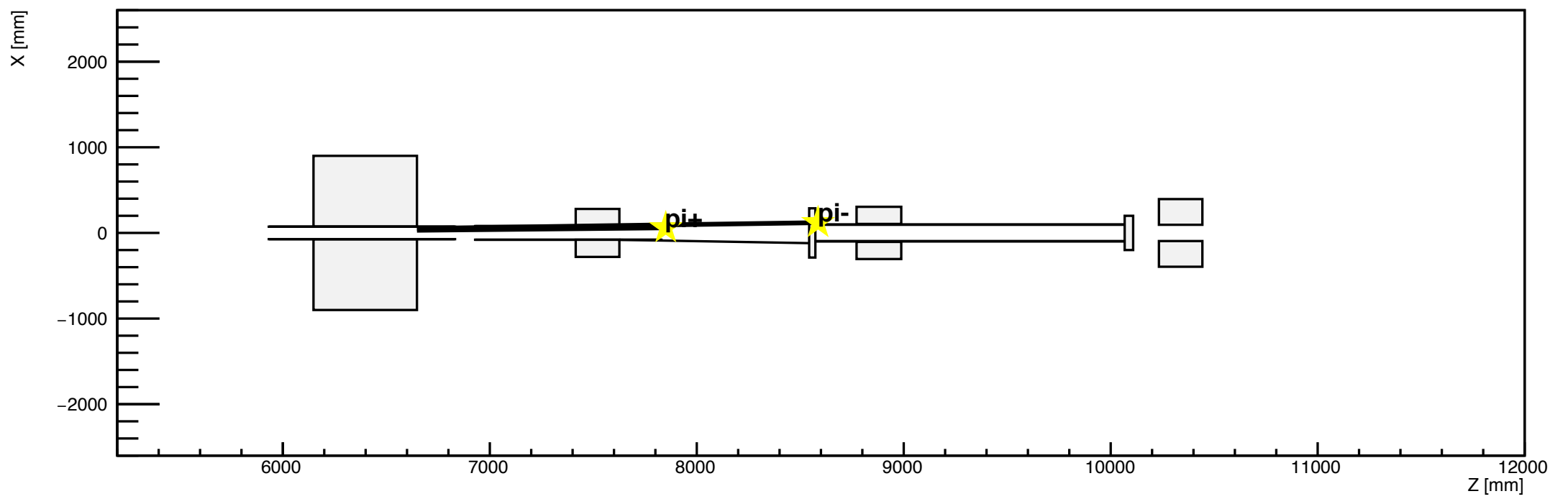

h1

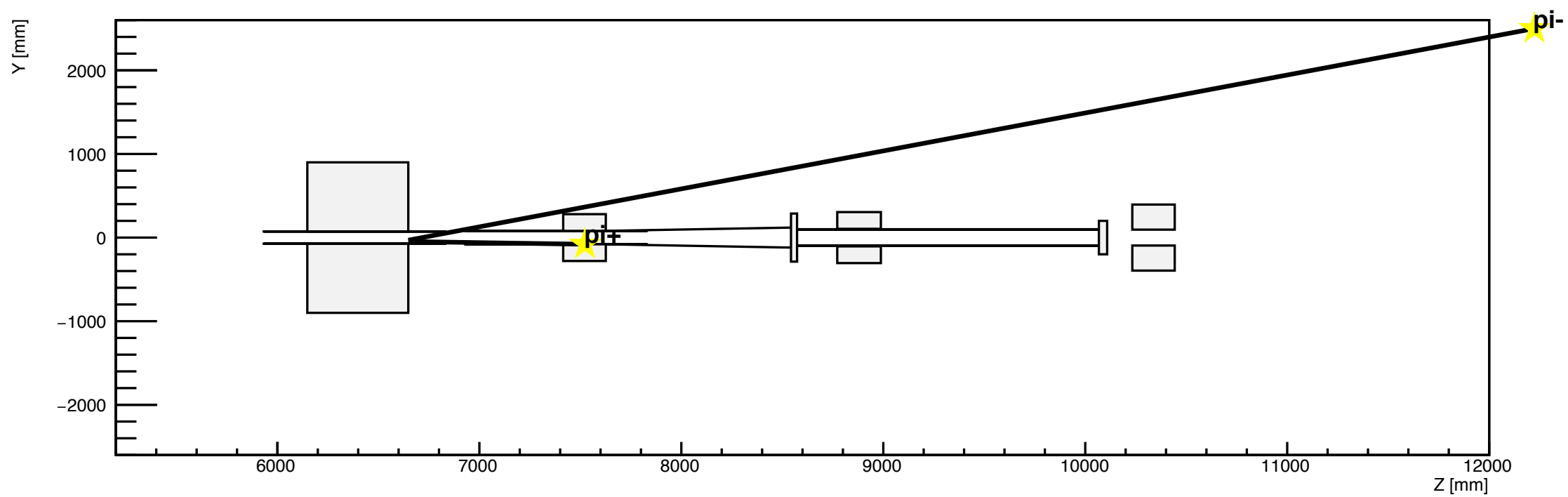

h2

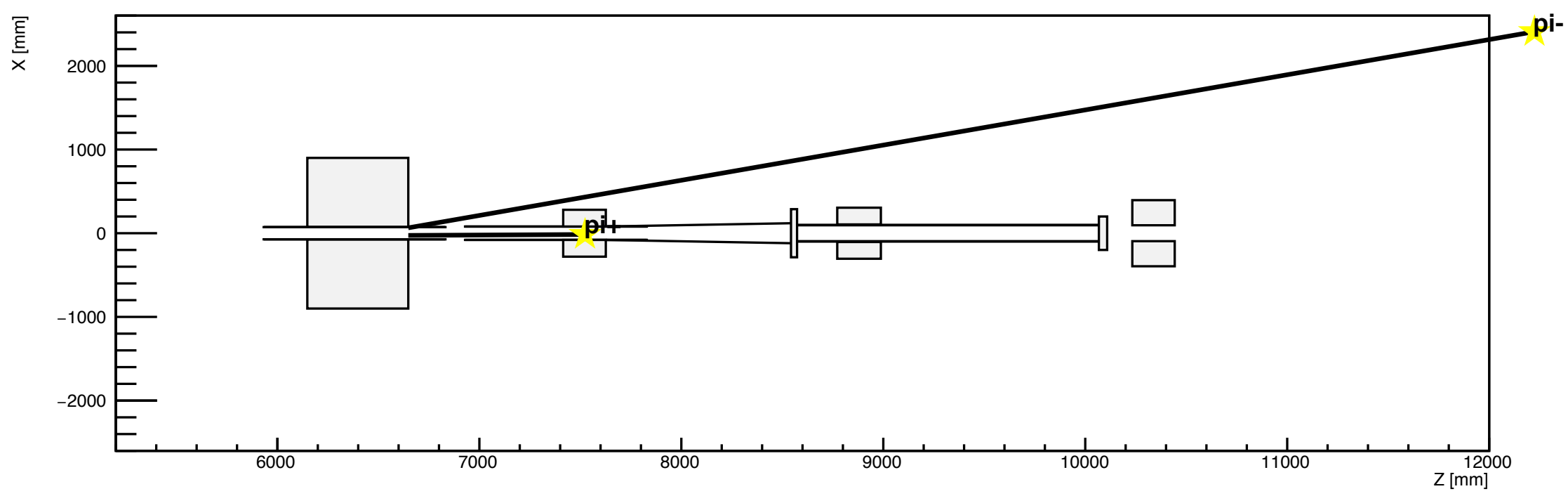

h1

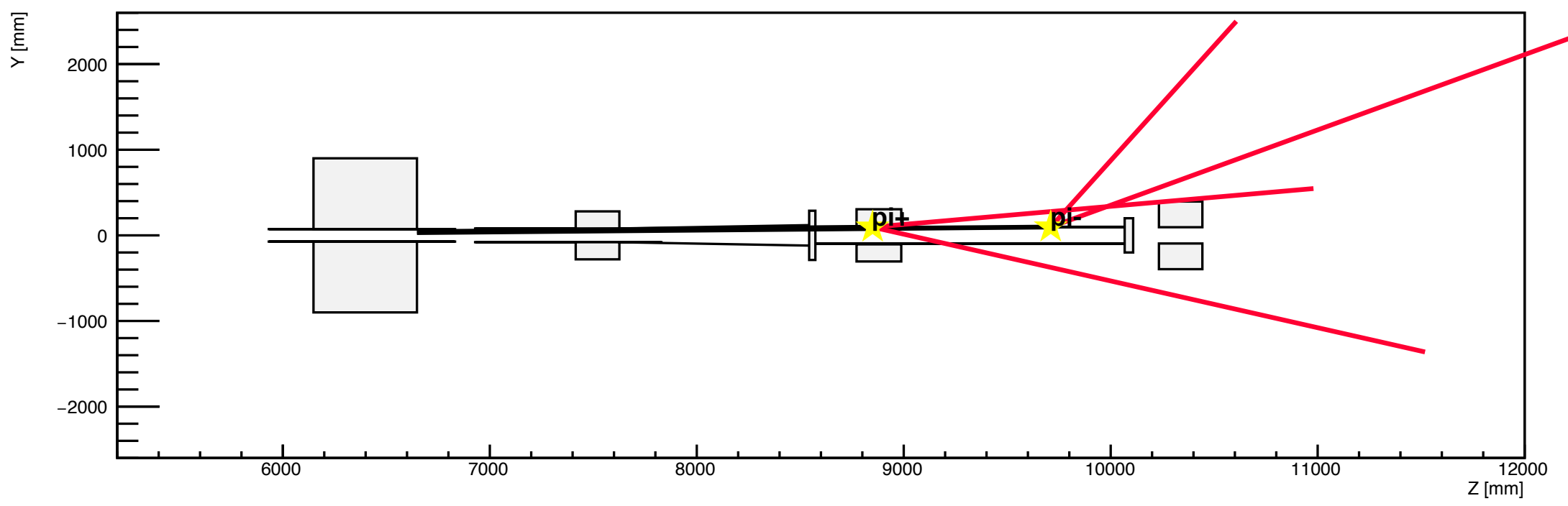

h2

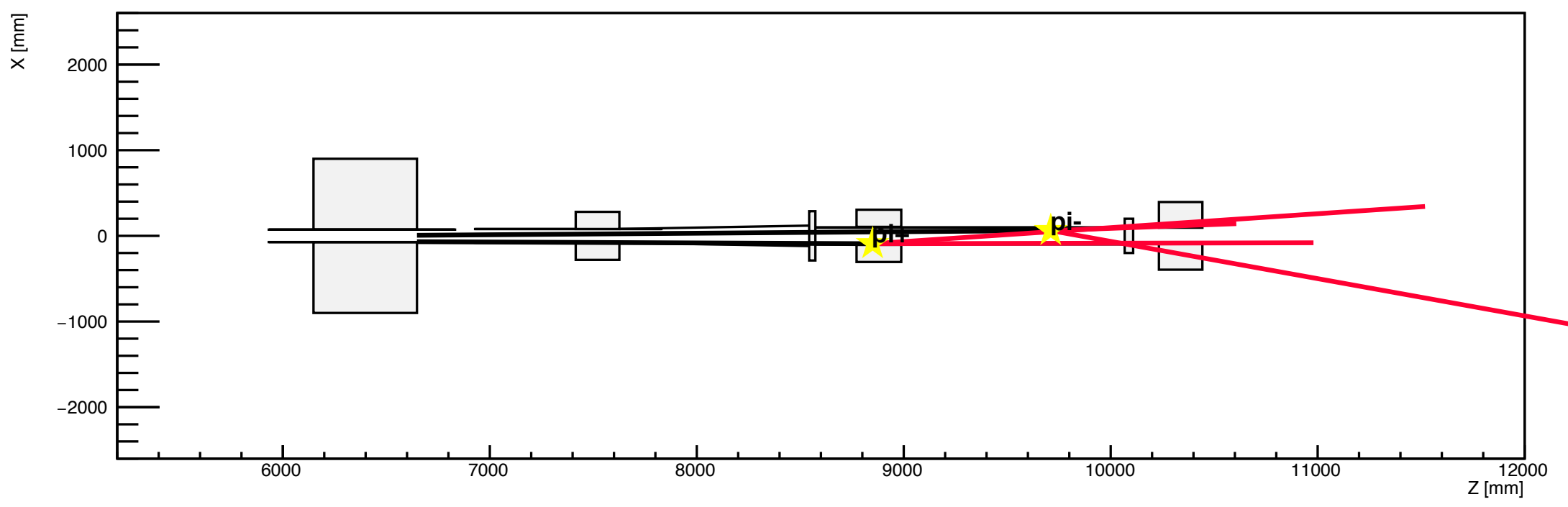

h1

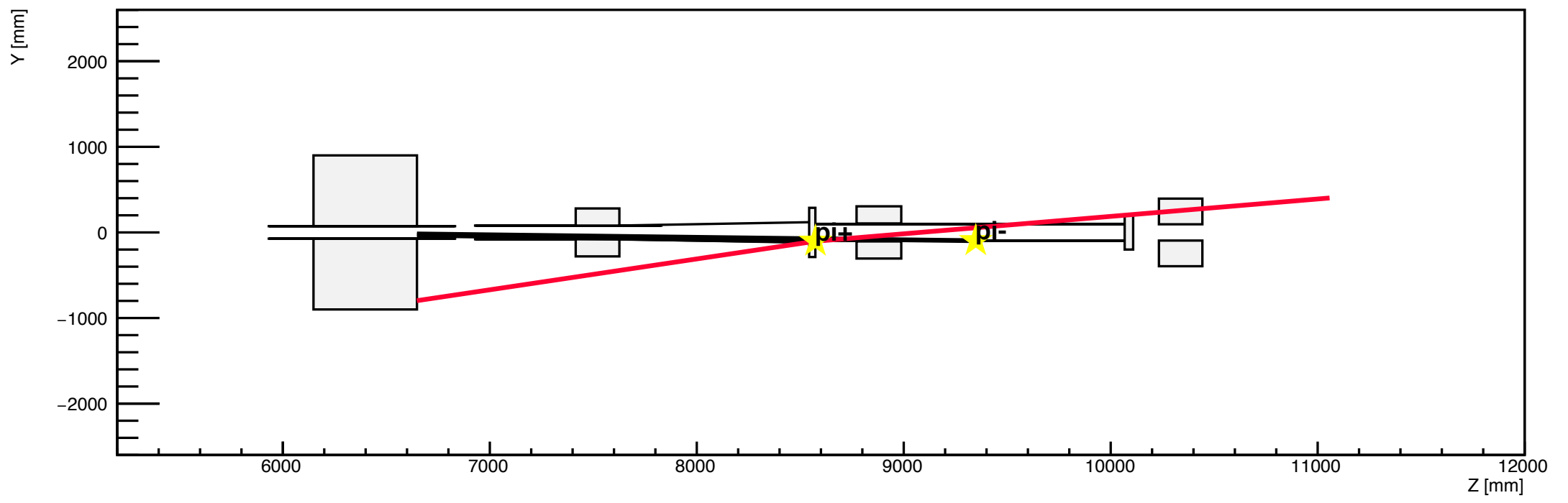

h2

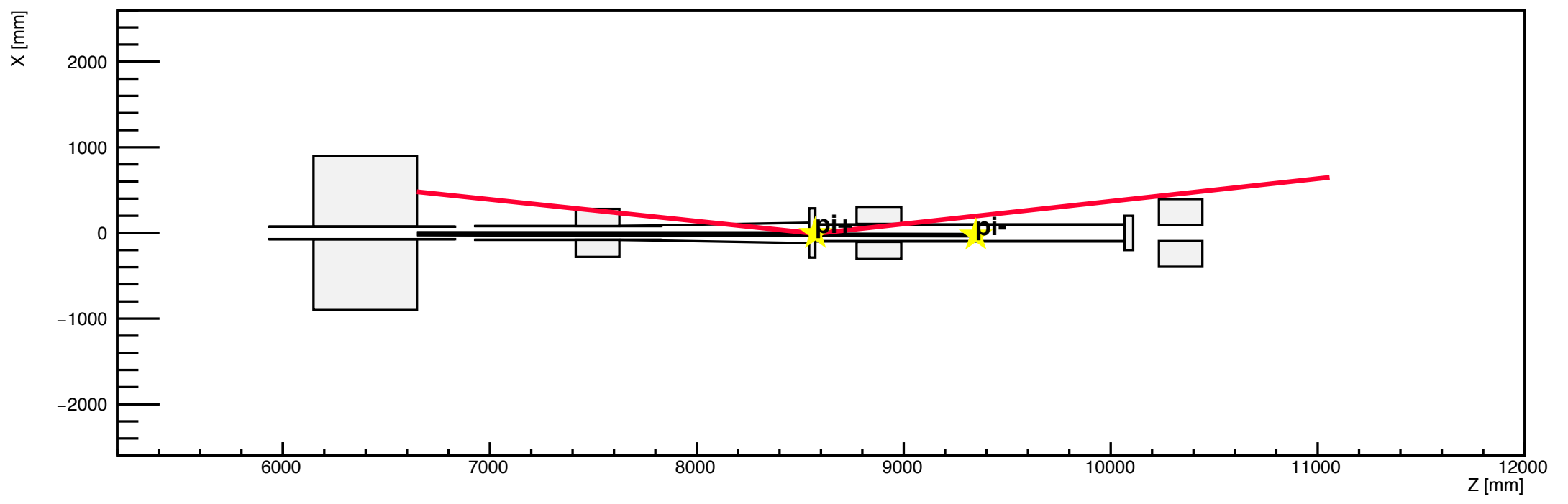

h1

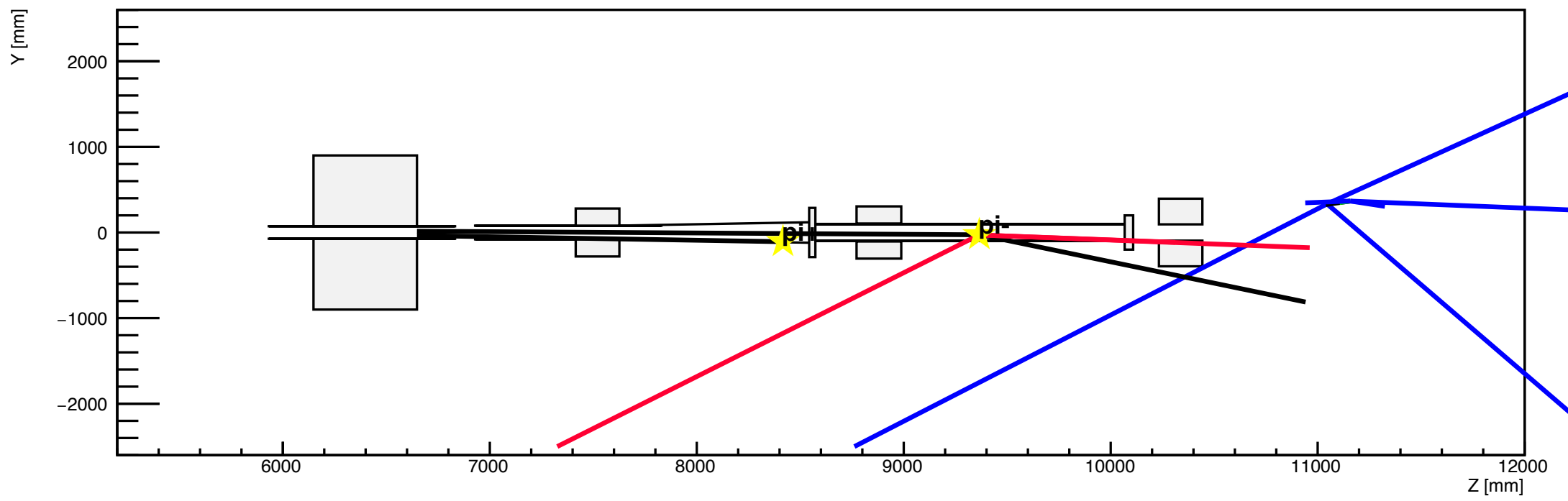

h2

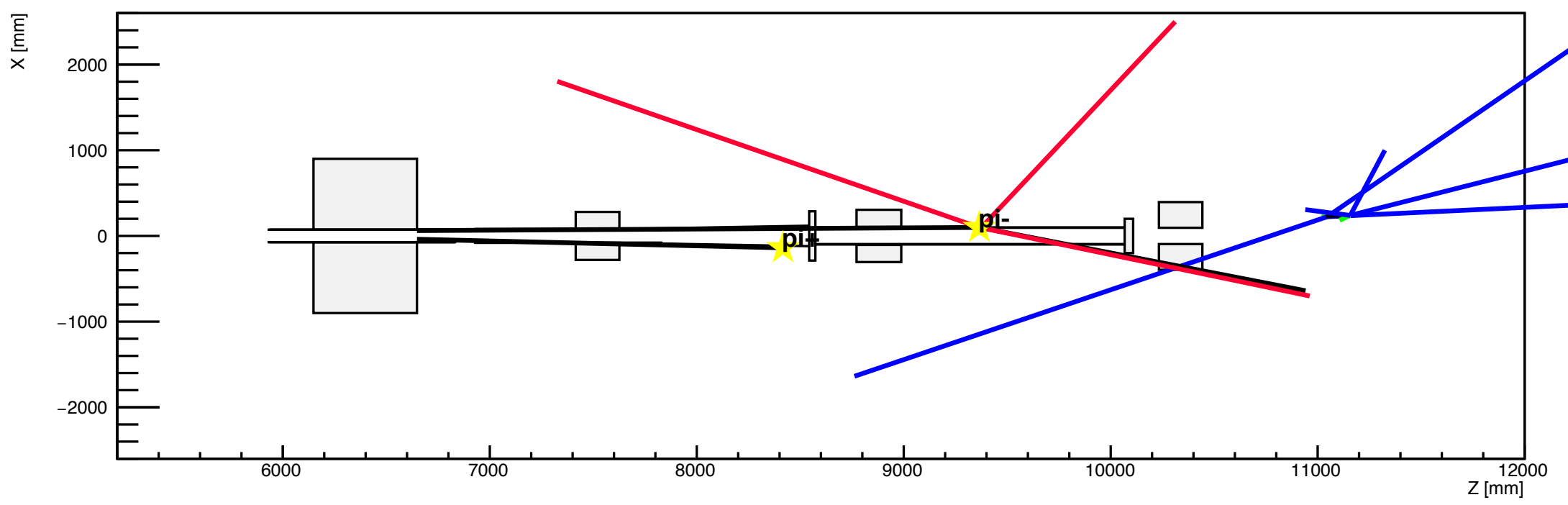

h1

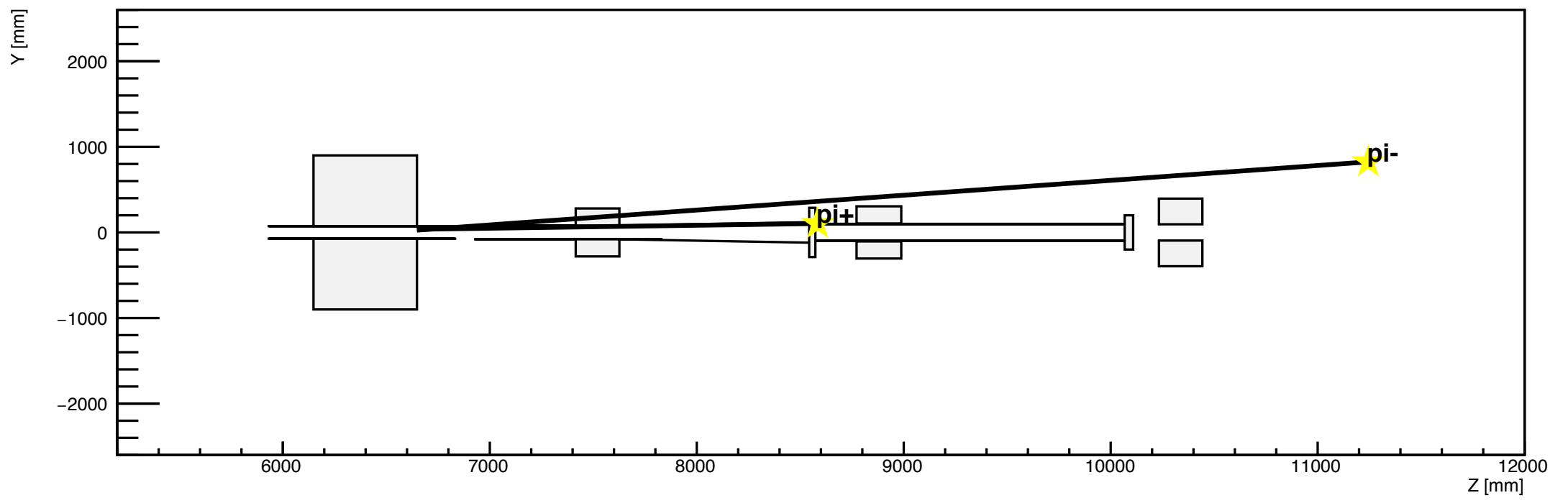

h2

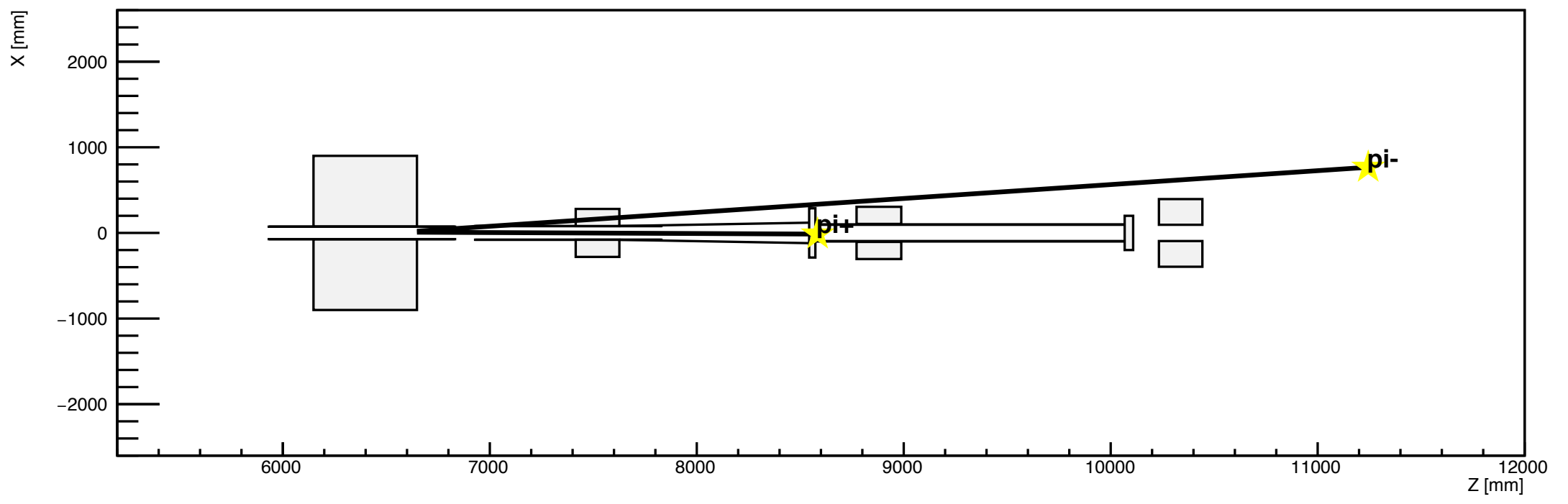

h1

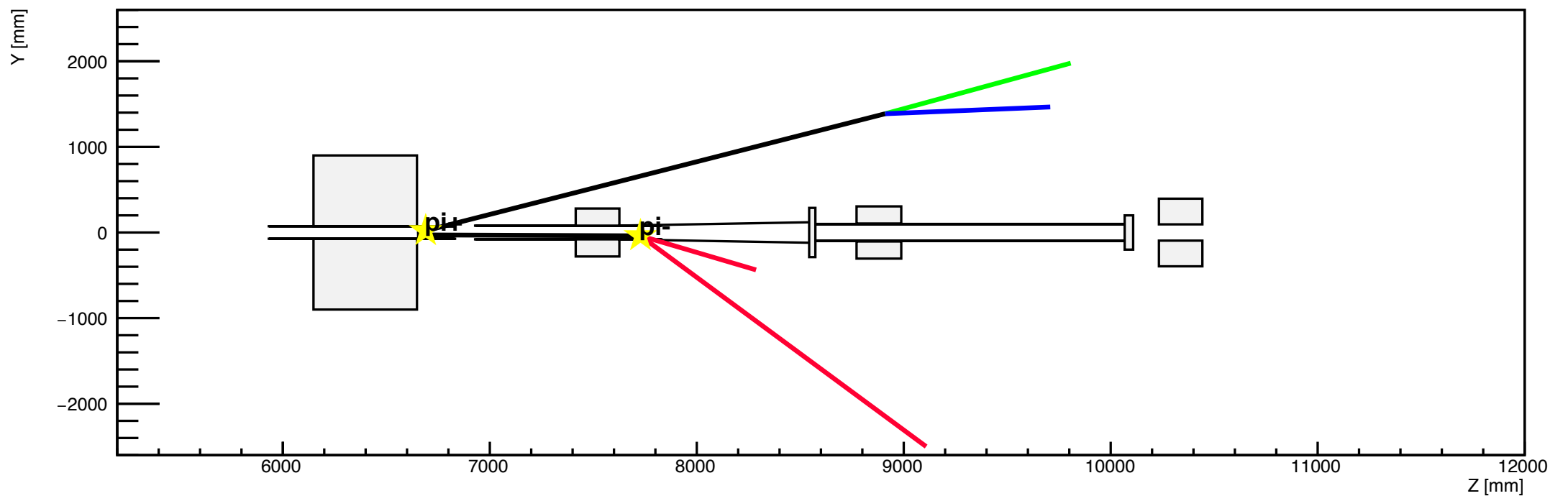

h2

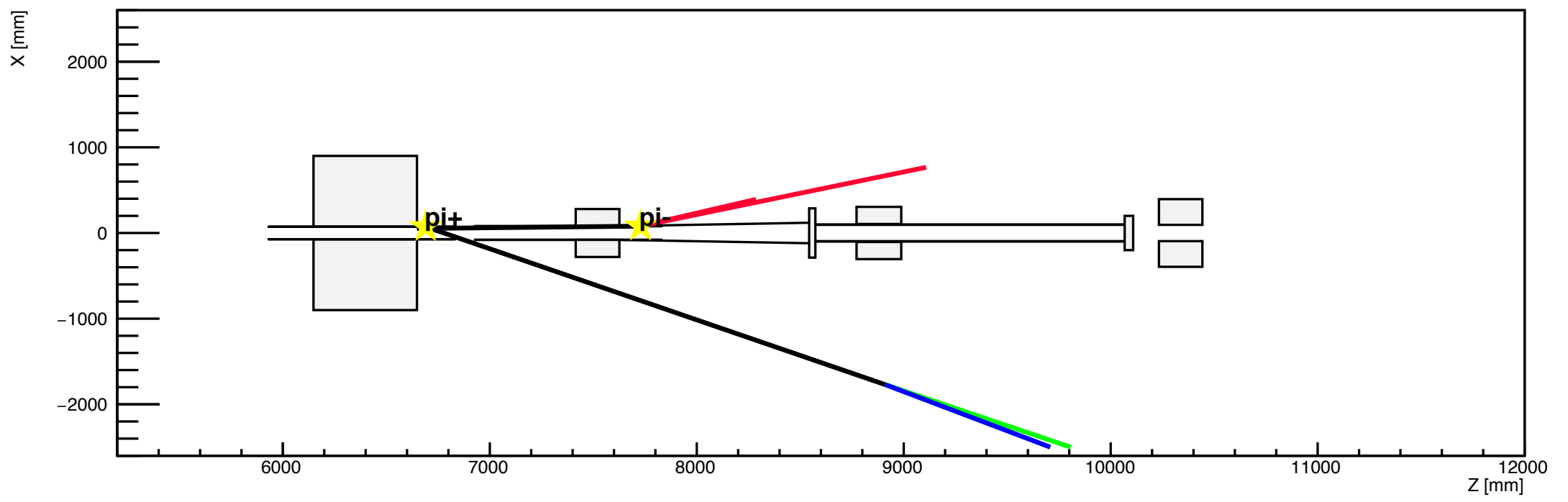

h1

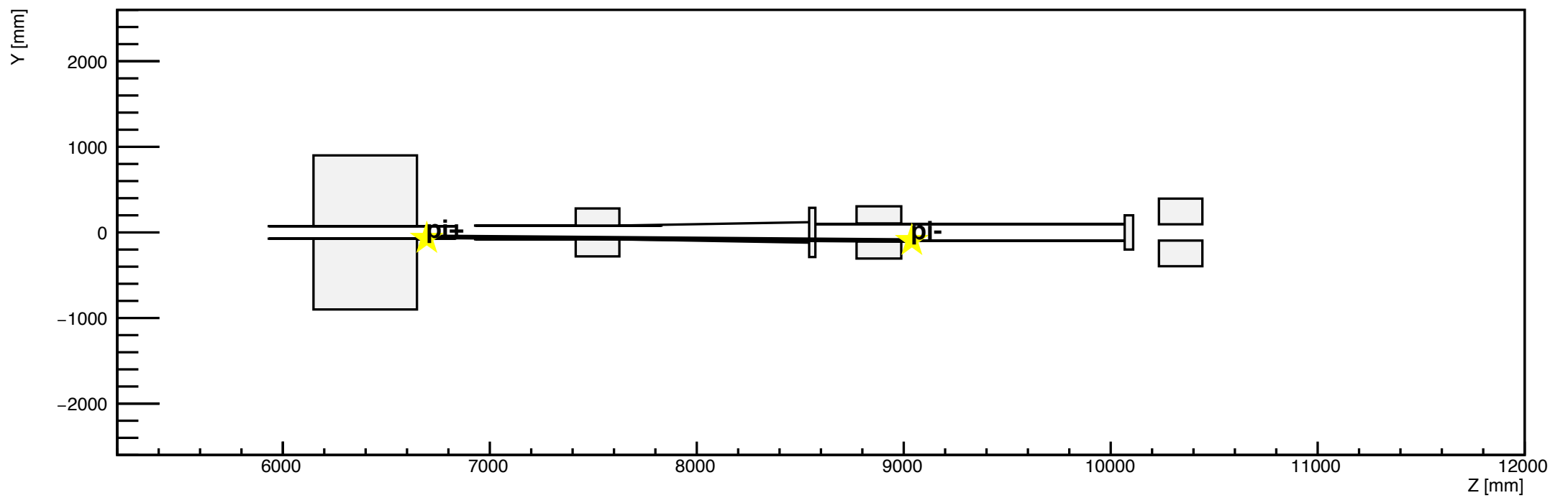

h2

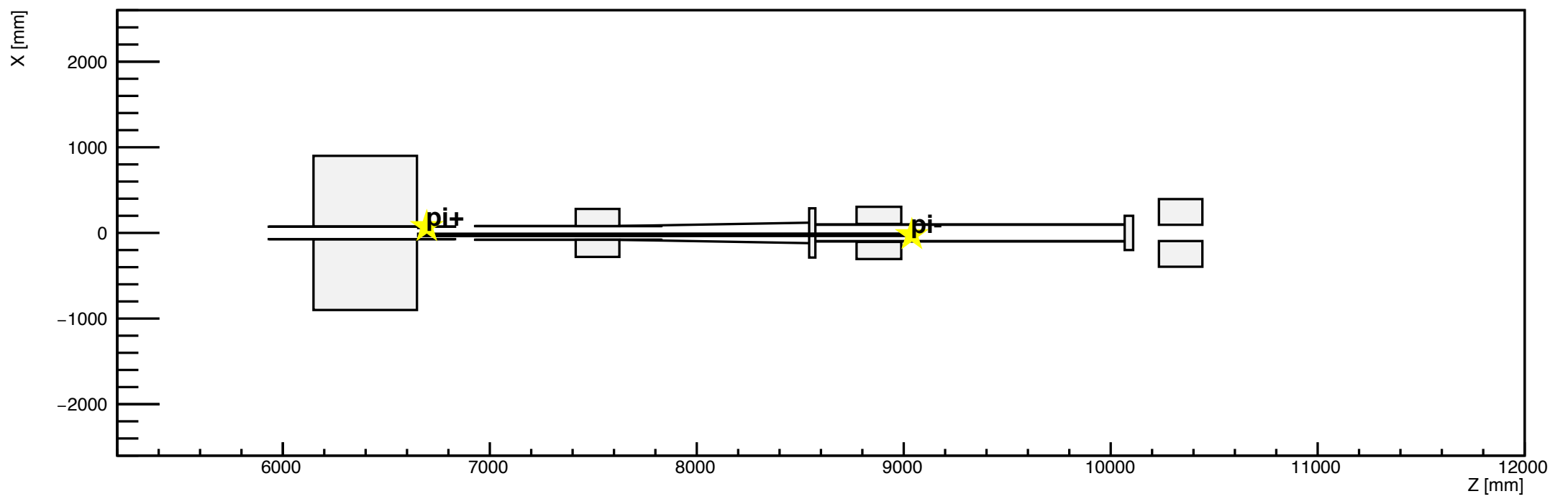

h1

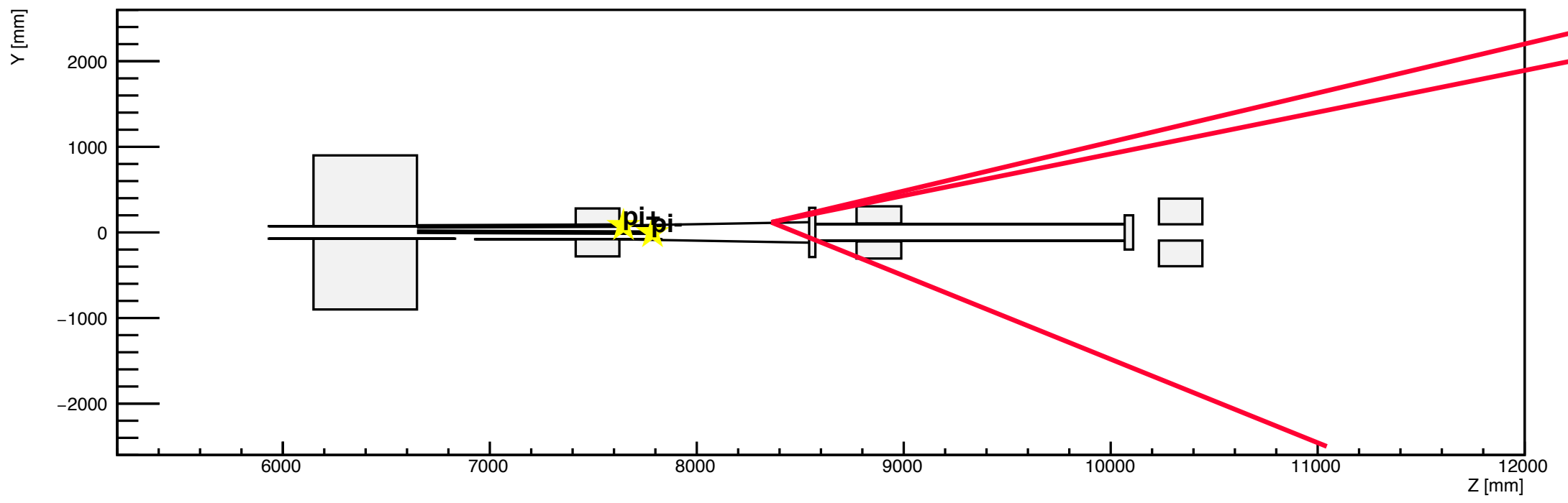

h2

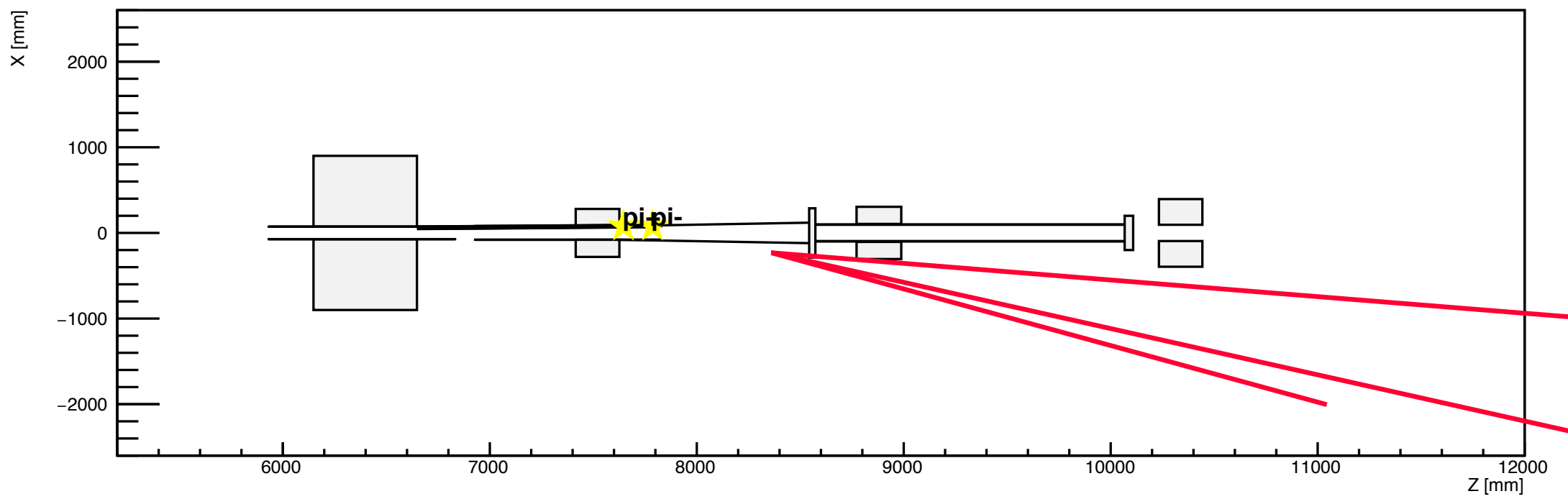

h1

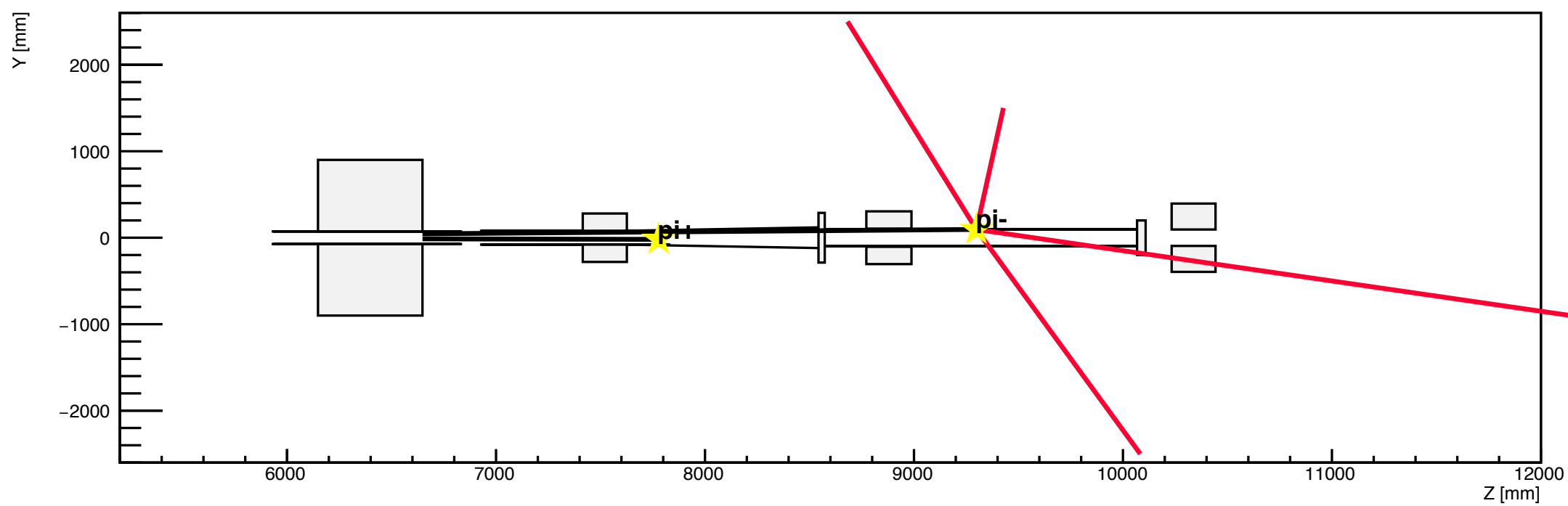

h2

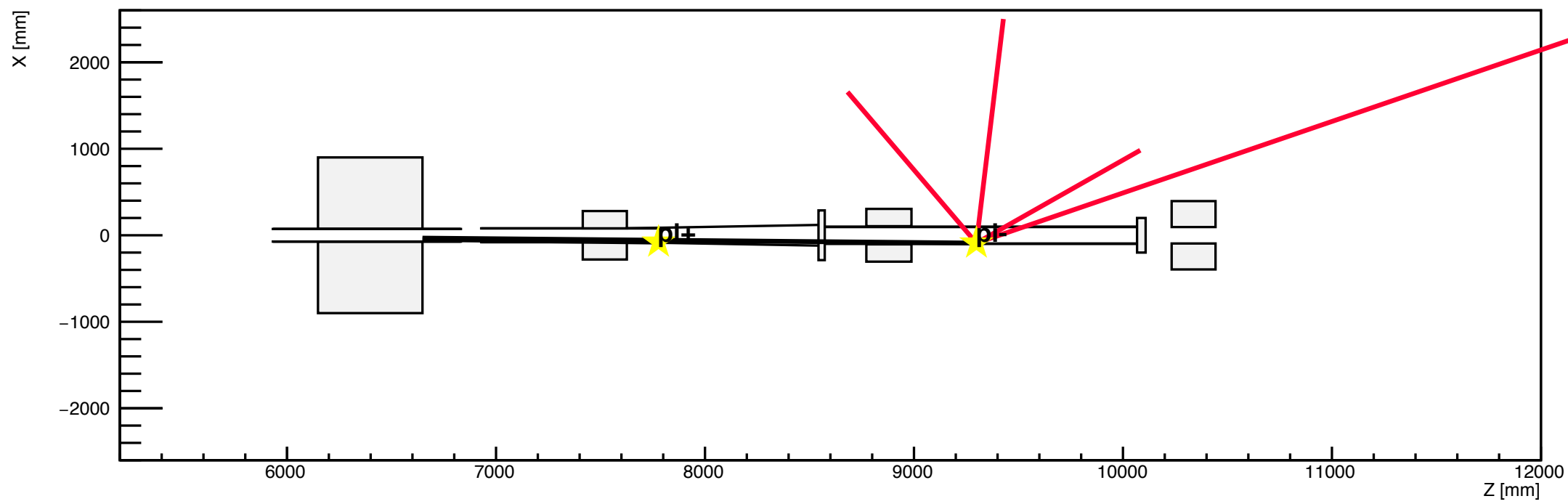

h1

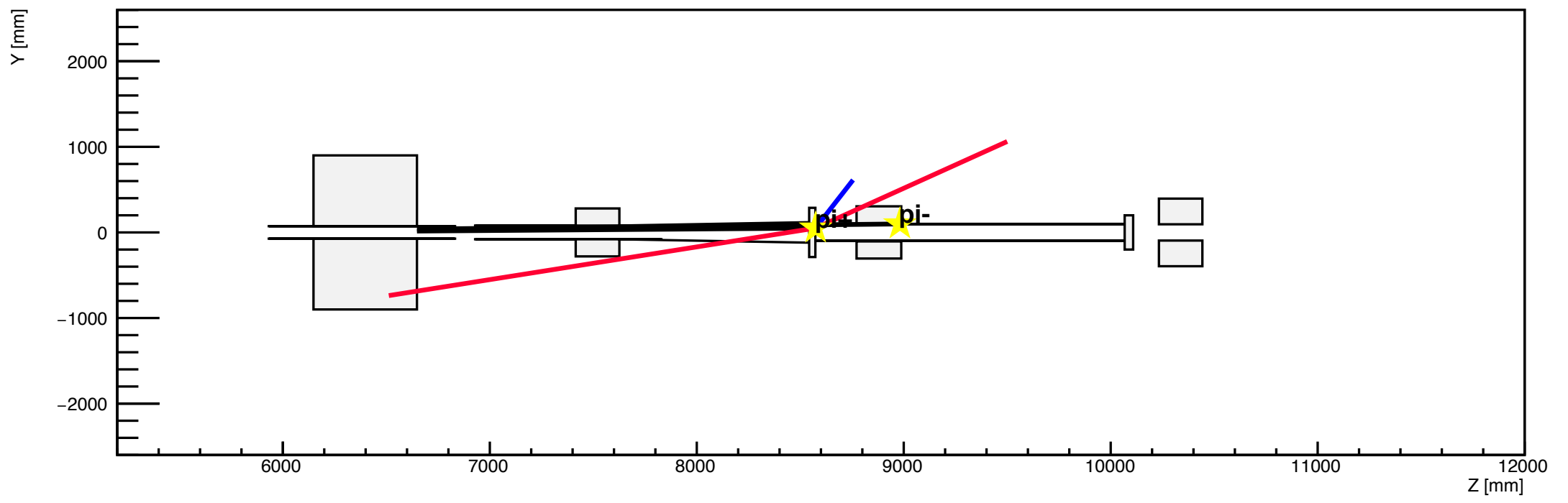

h2

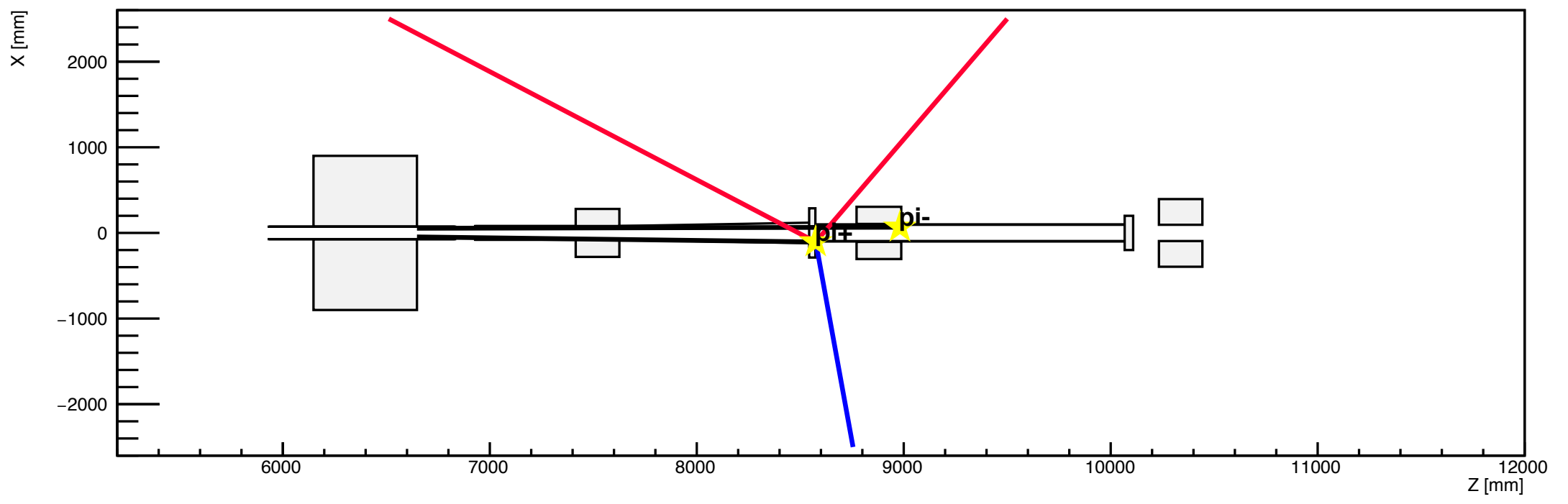

h1

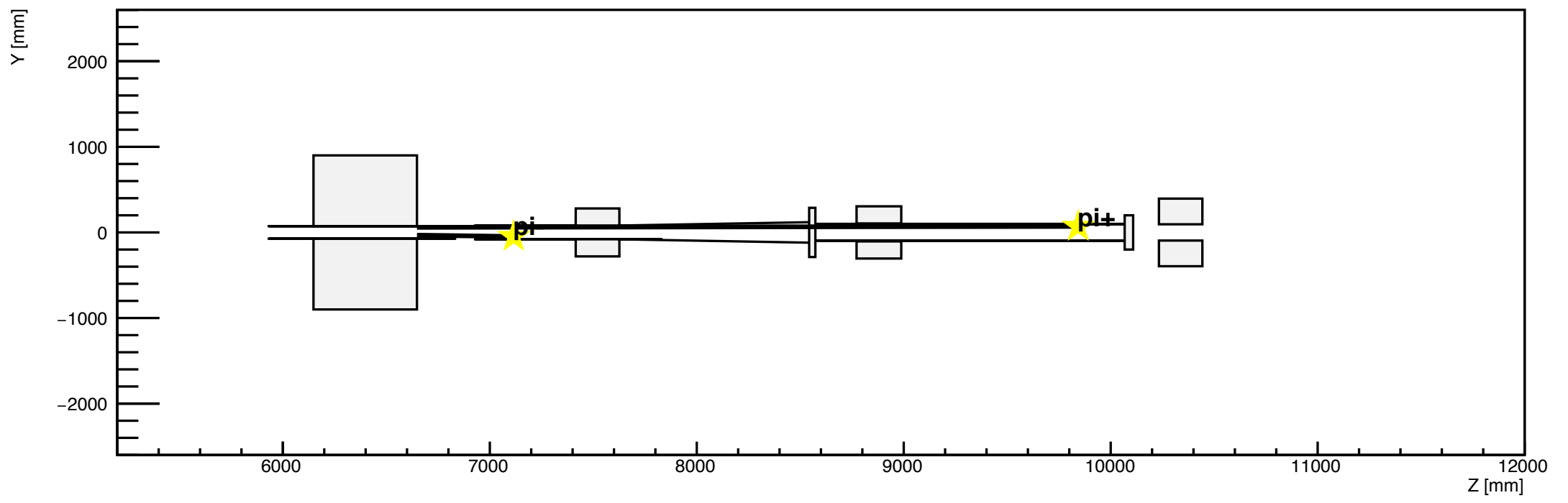

h2

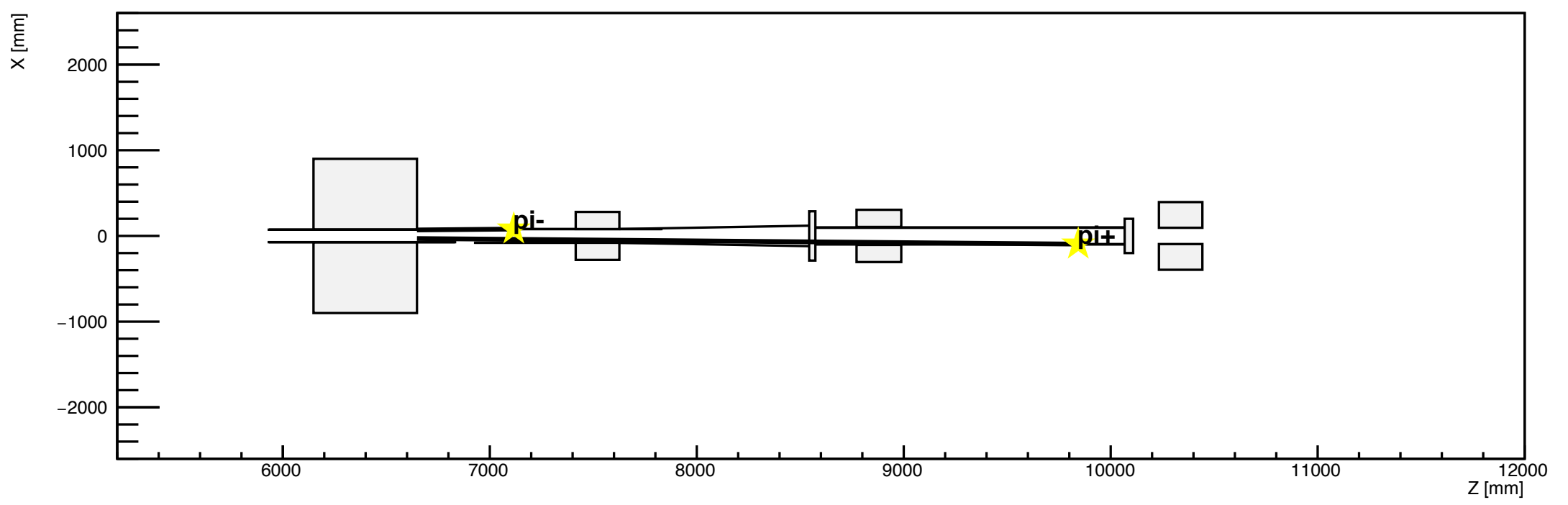

h1

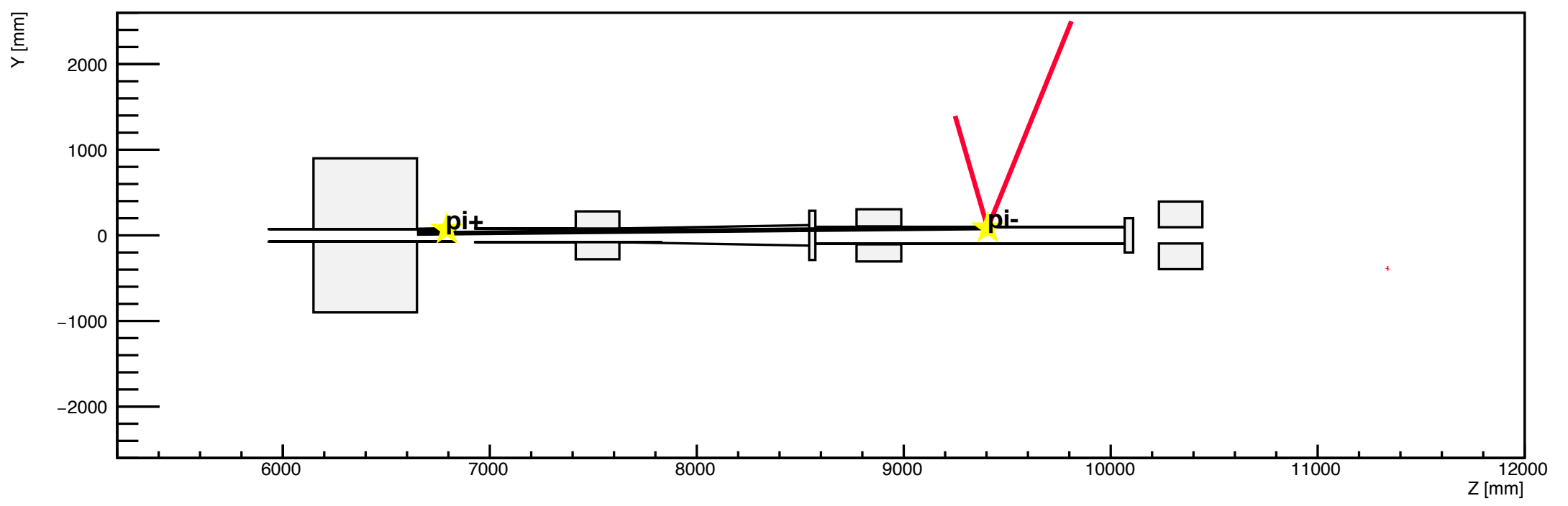

h2

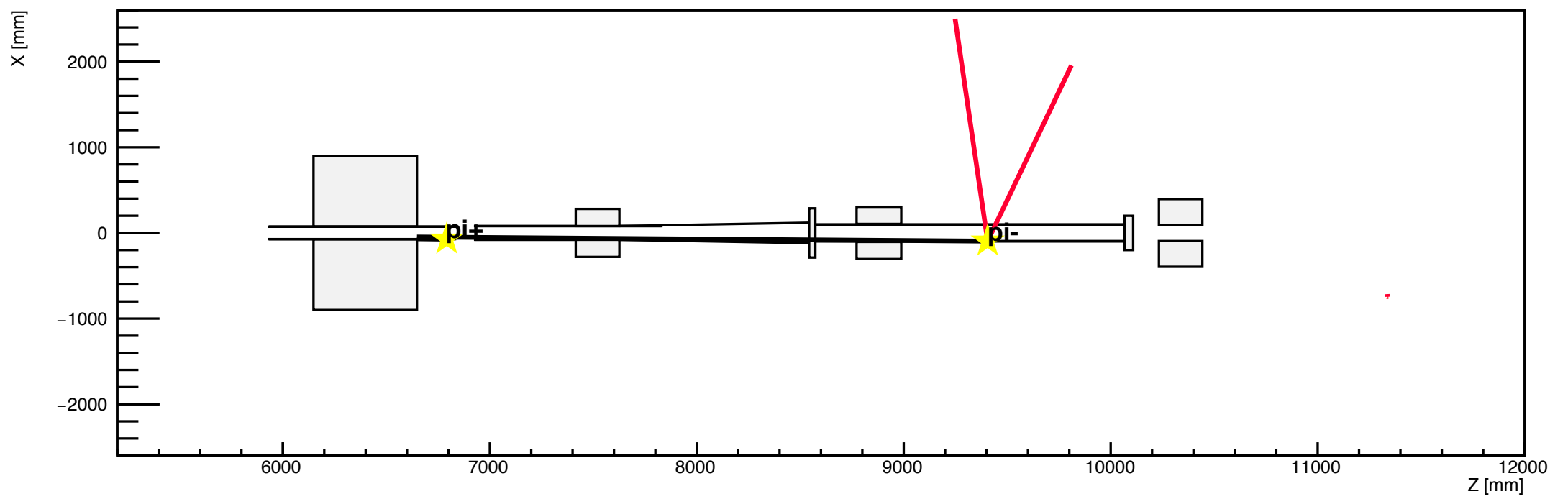

h1

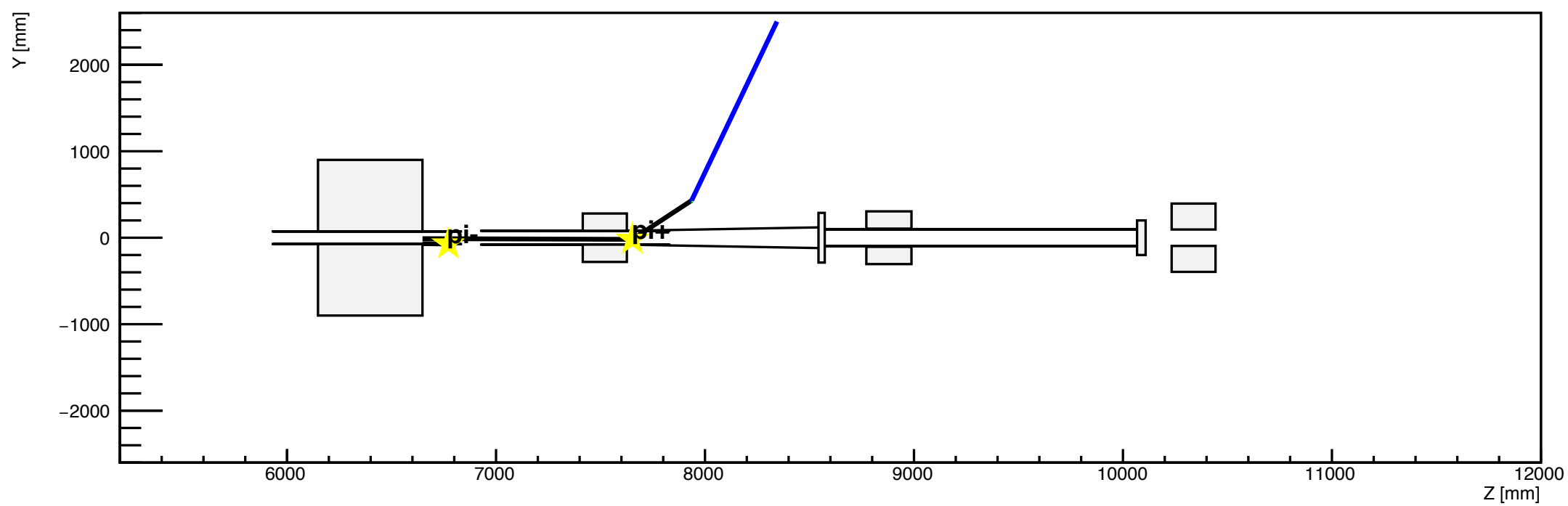

h2

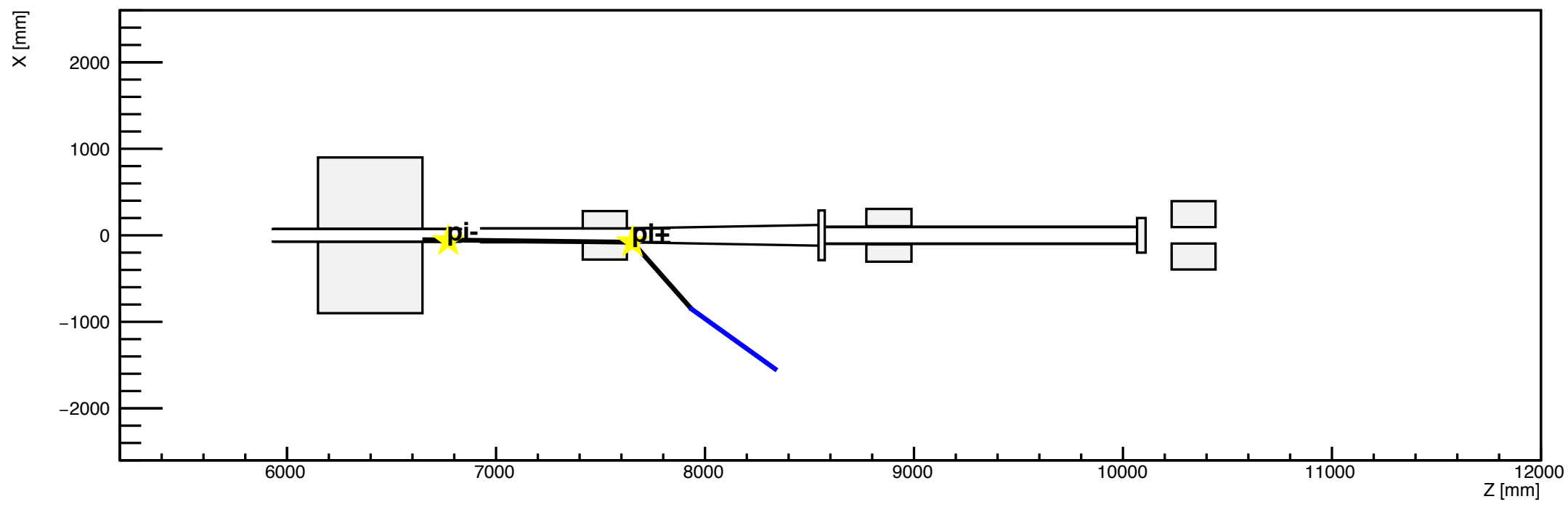

h1

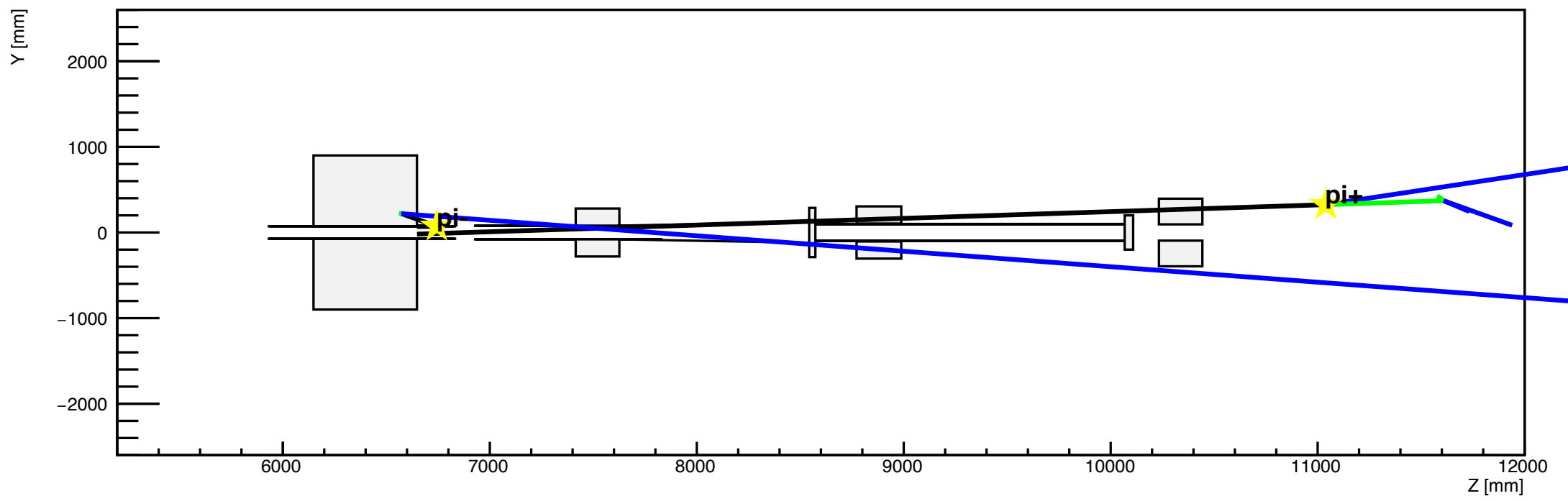

h2

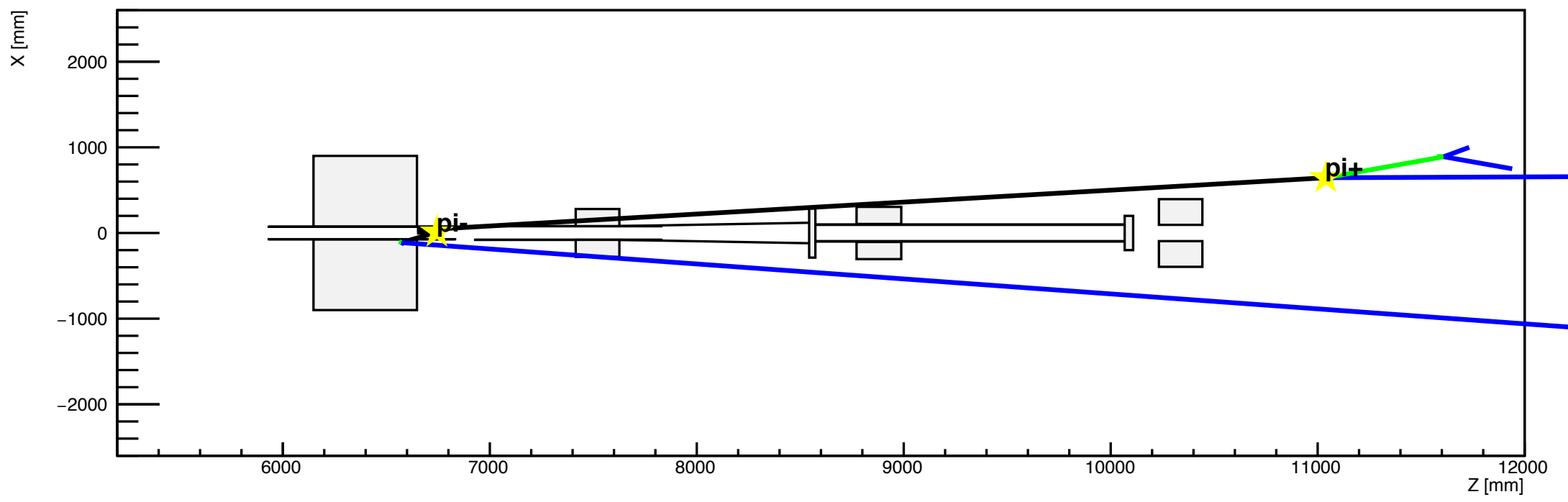

h1

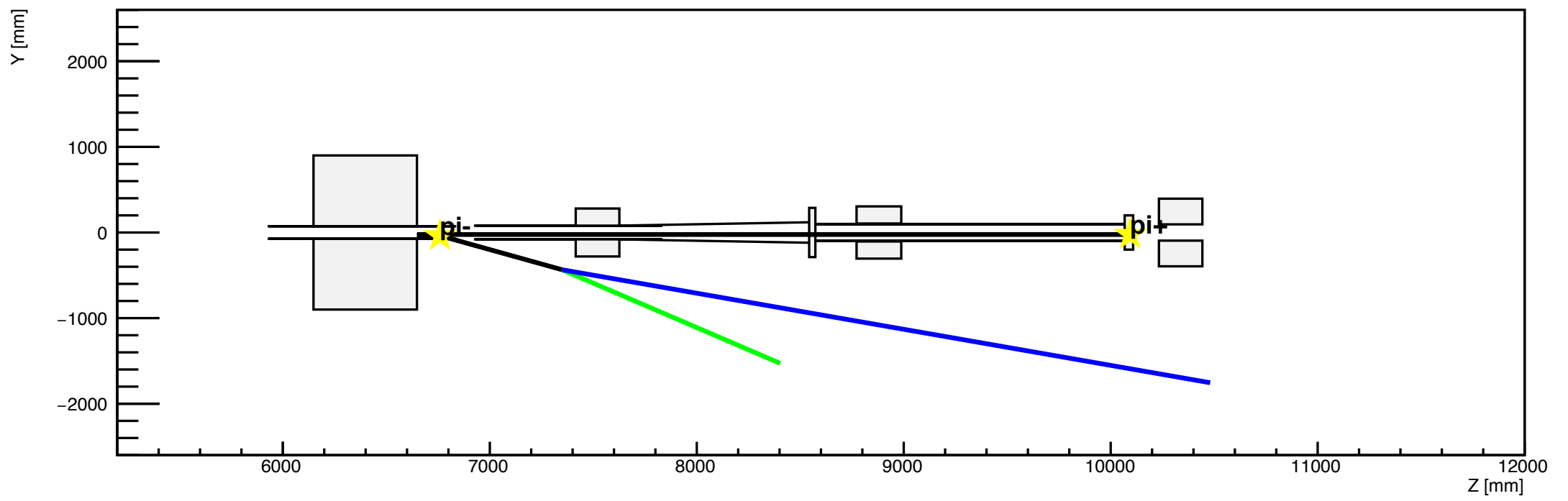

h2

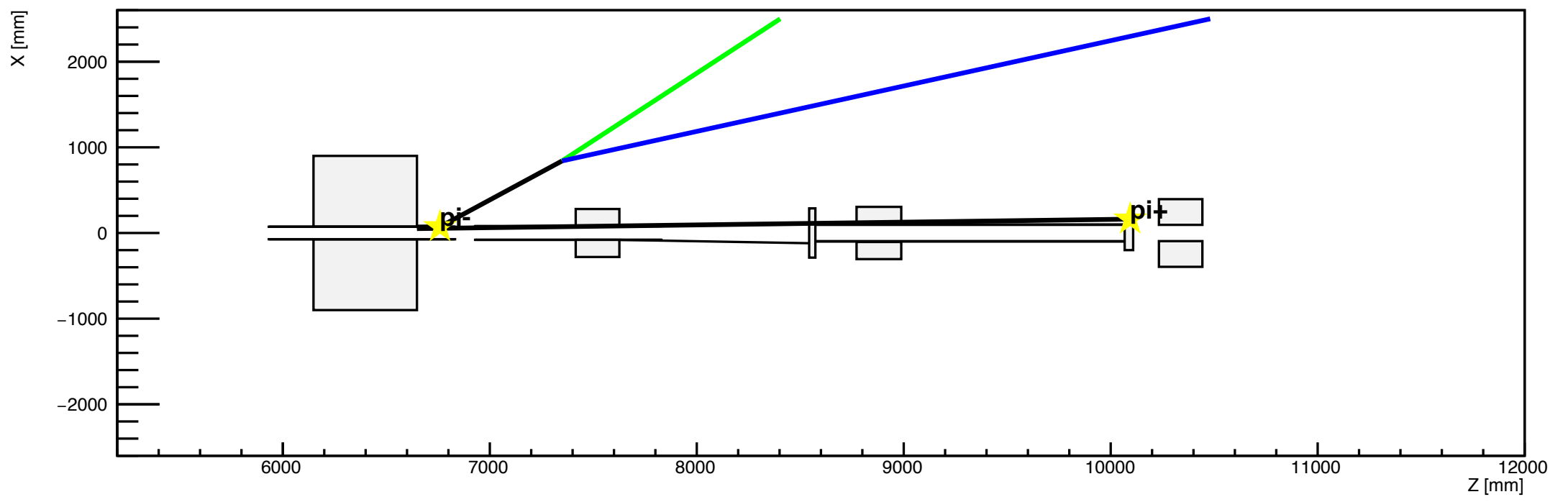

h1

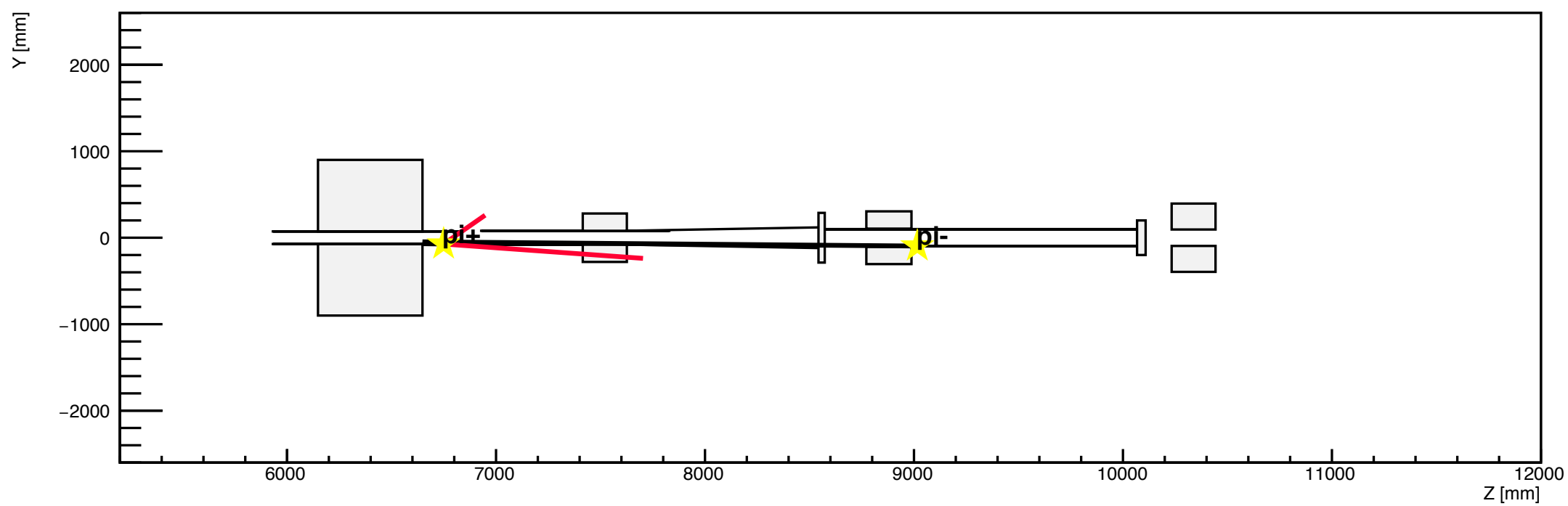

h2

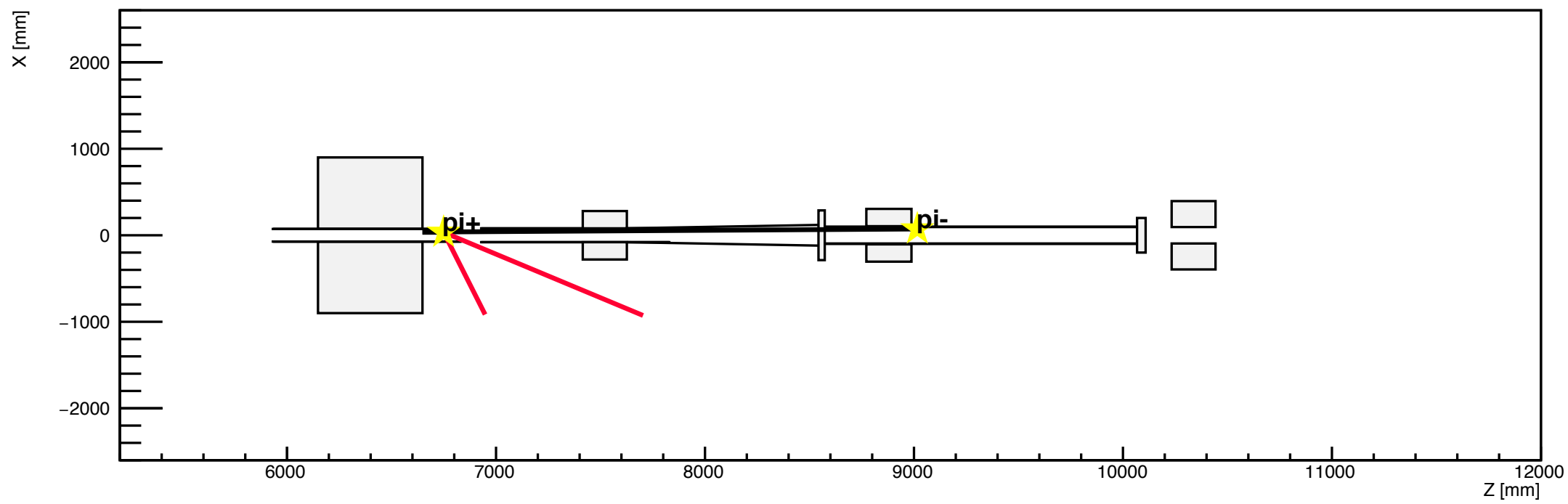

h1

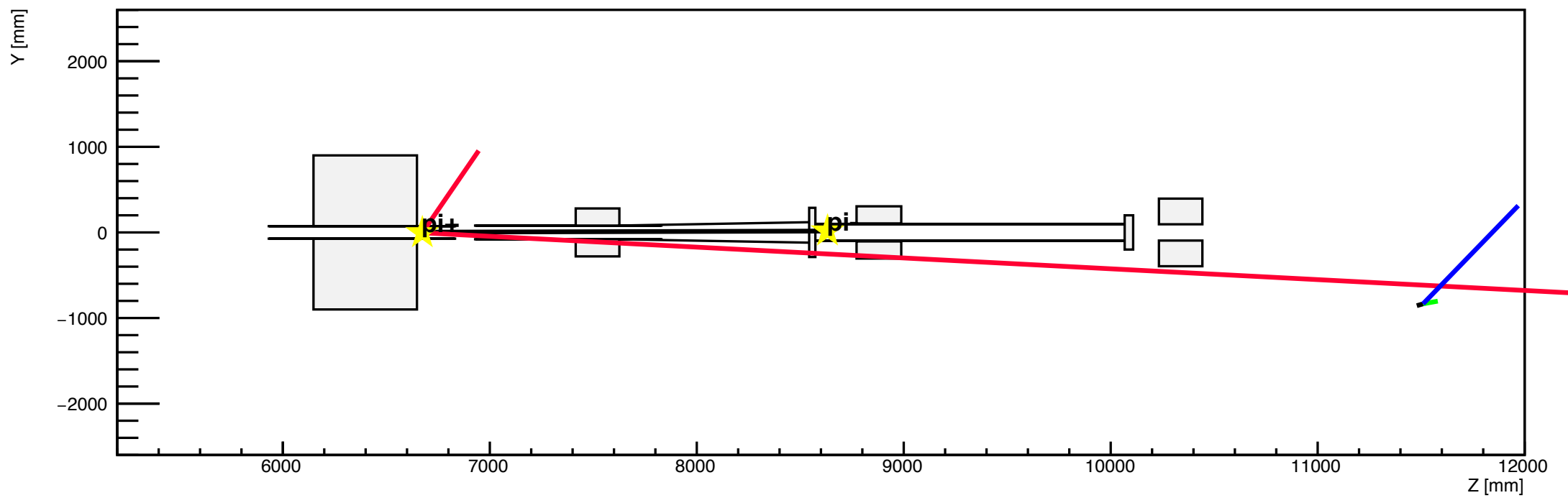

h2

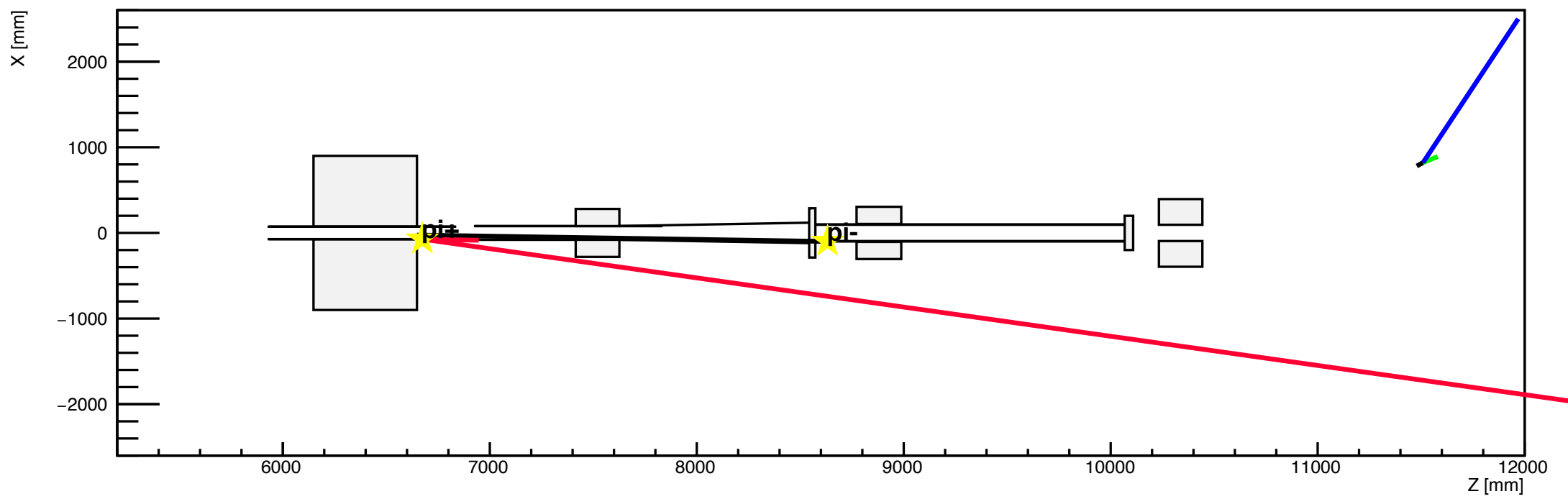

h1

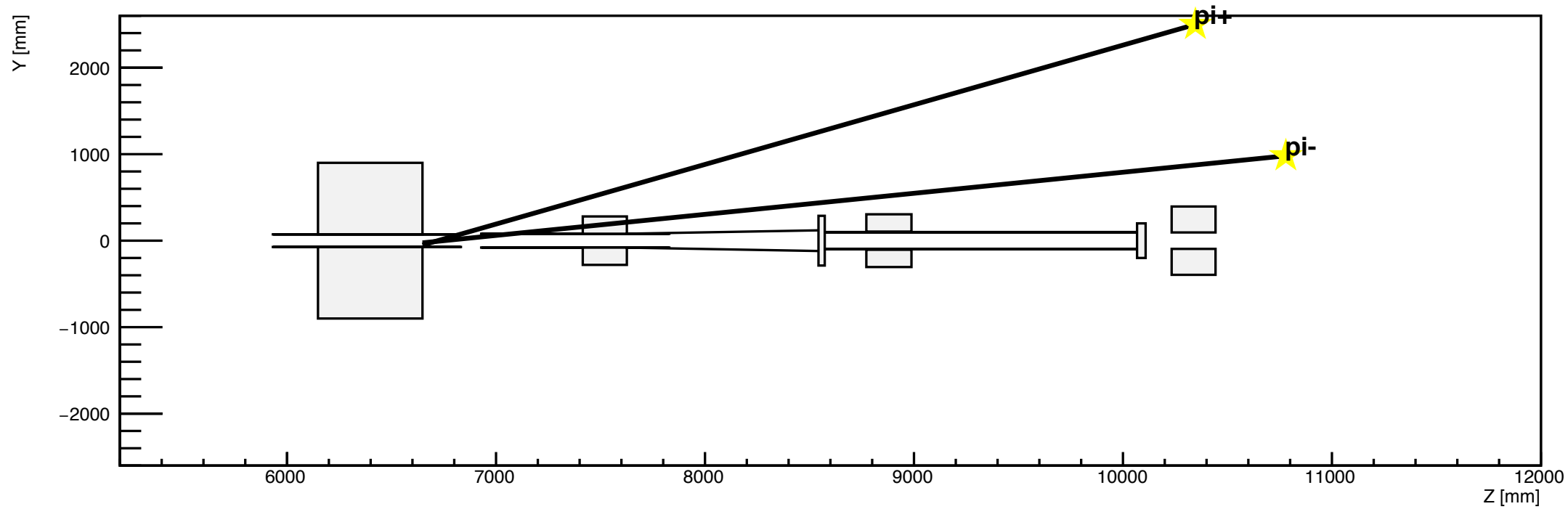

h2

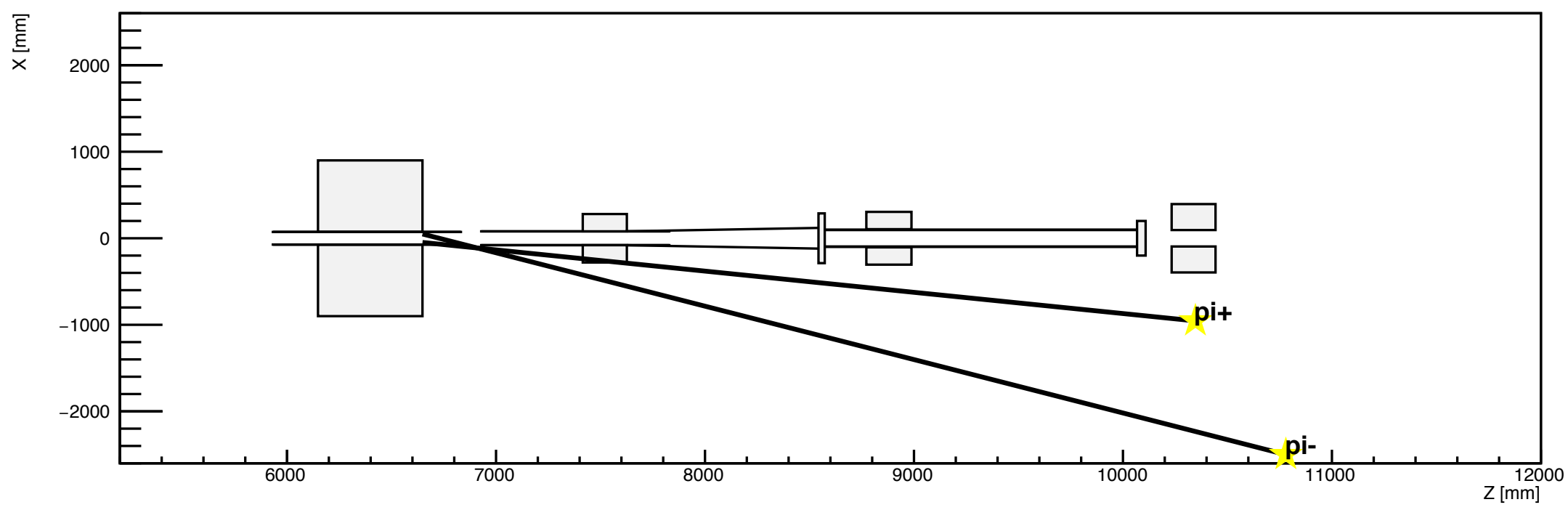

h1

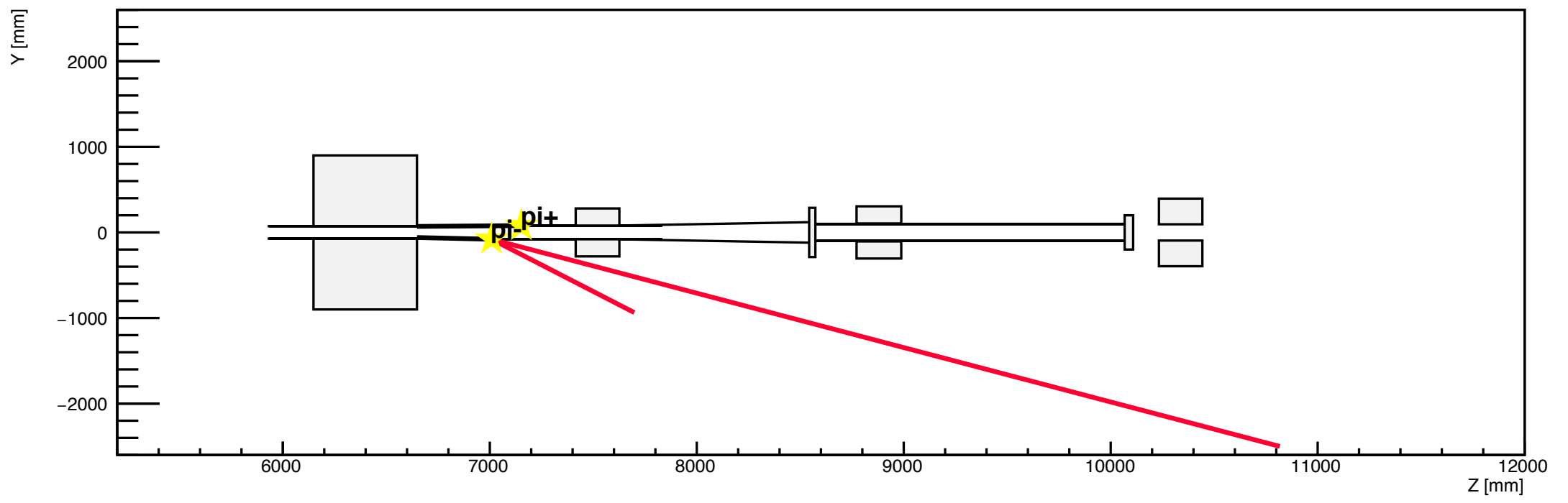

h2

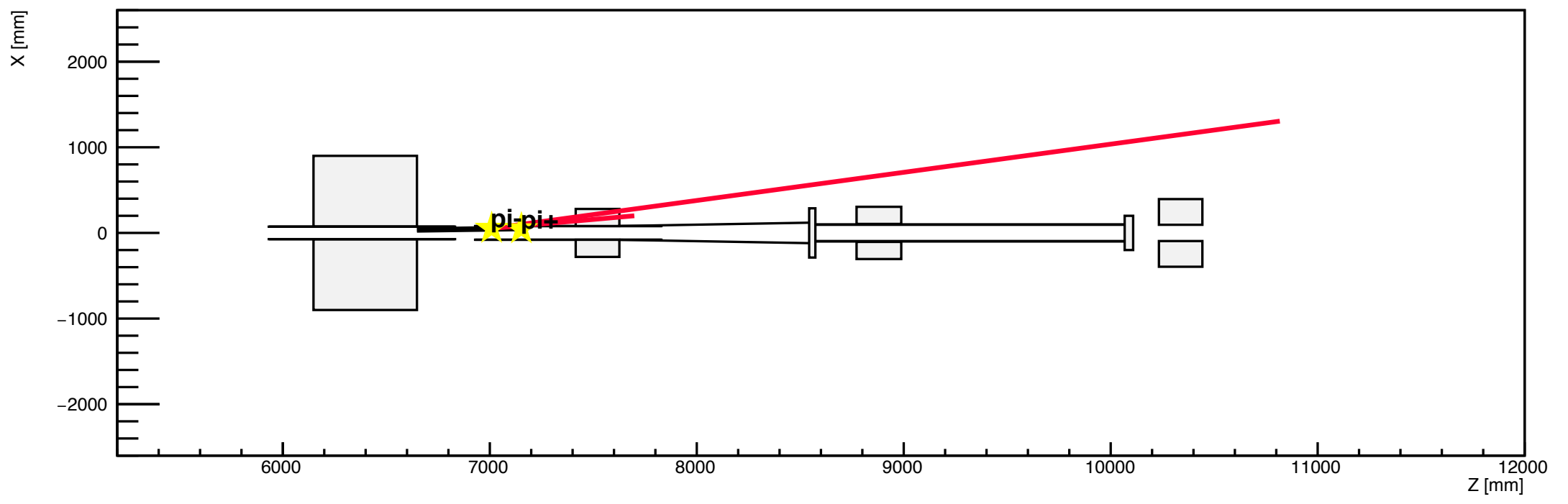

h1

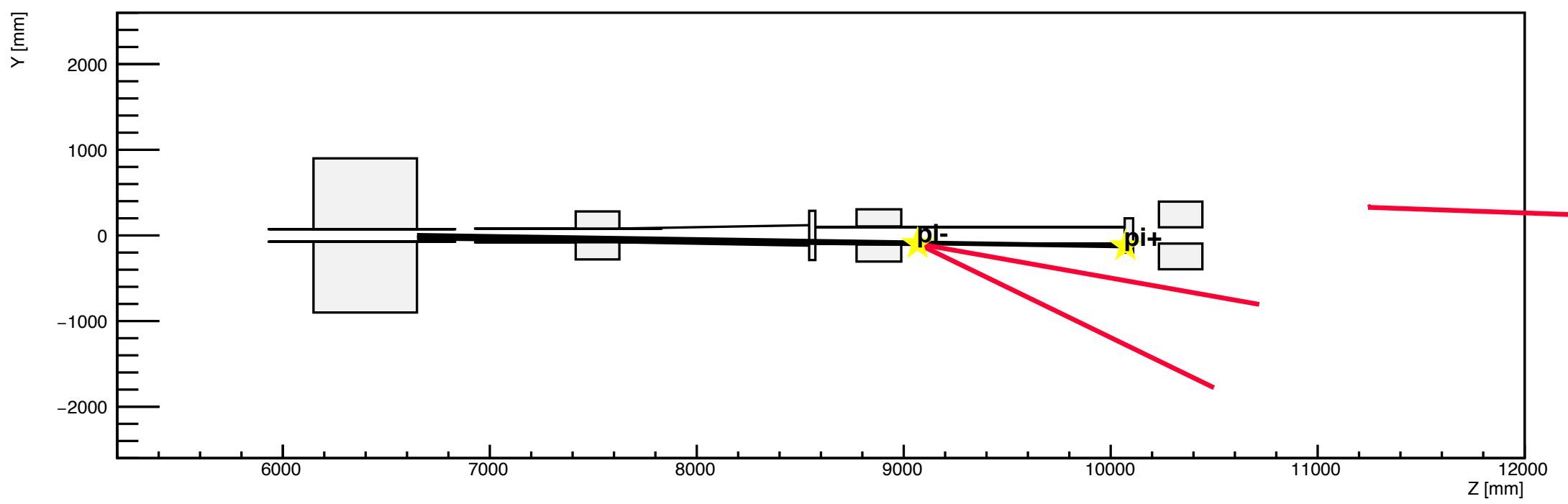

h2

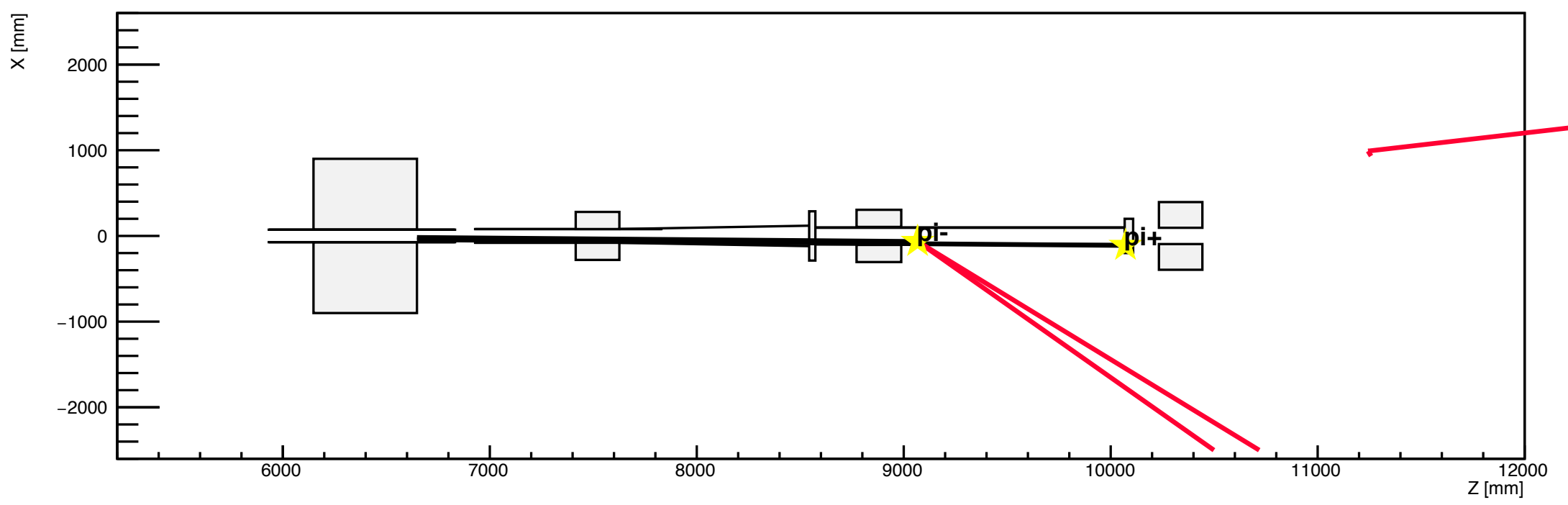

h1

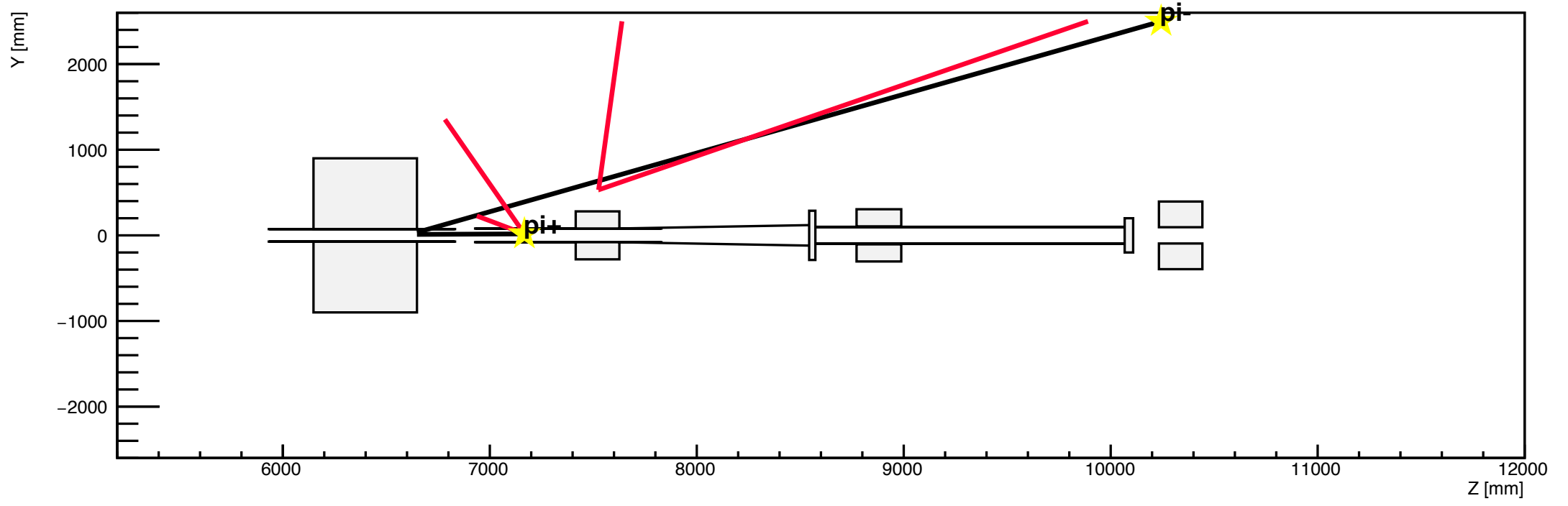

h2

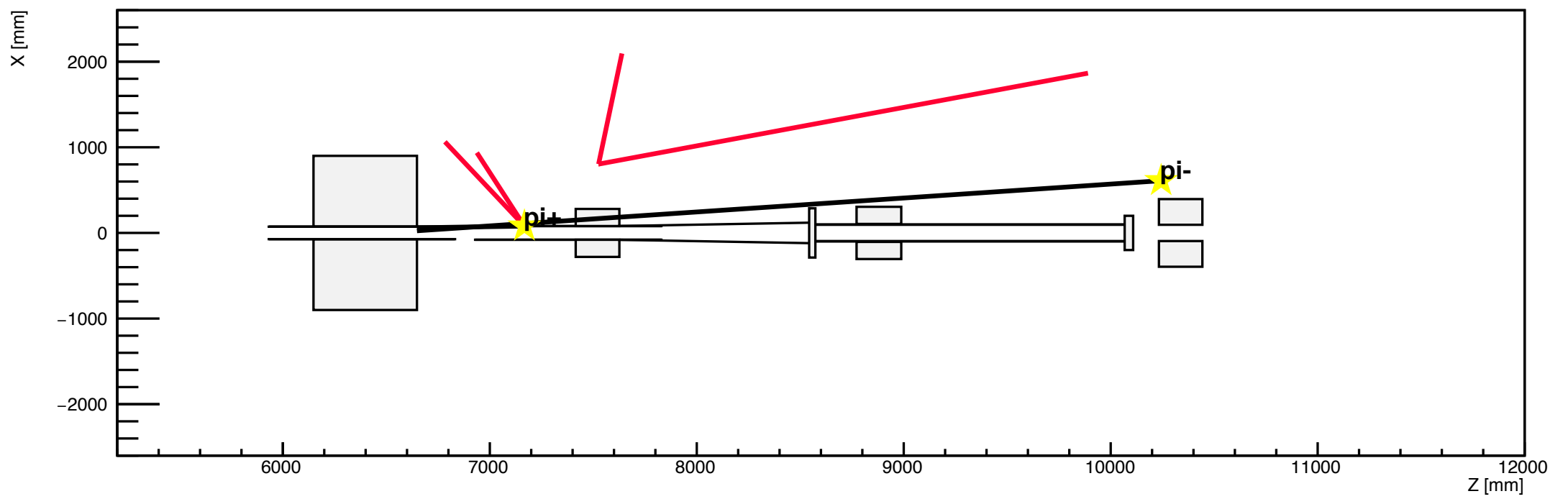

h1

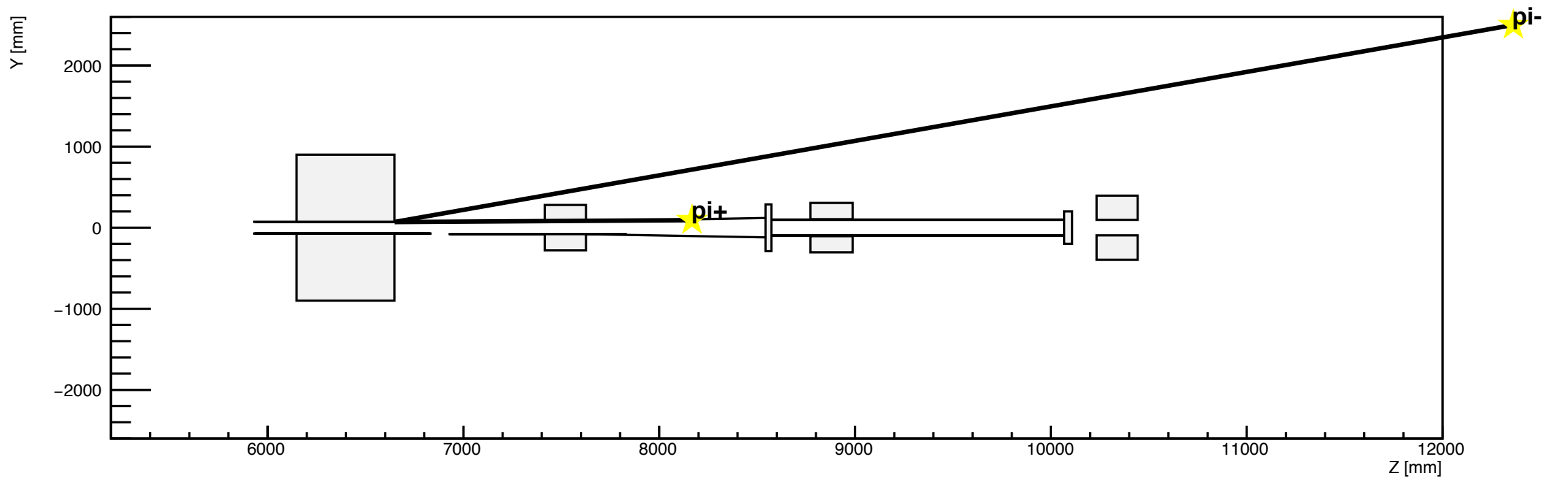

h2

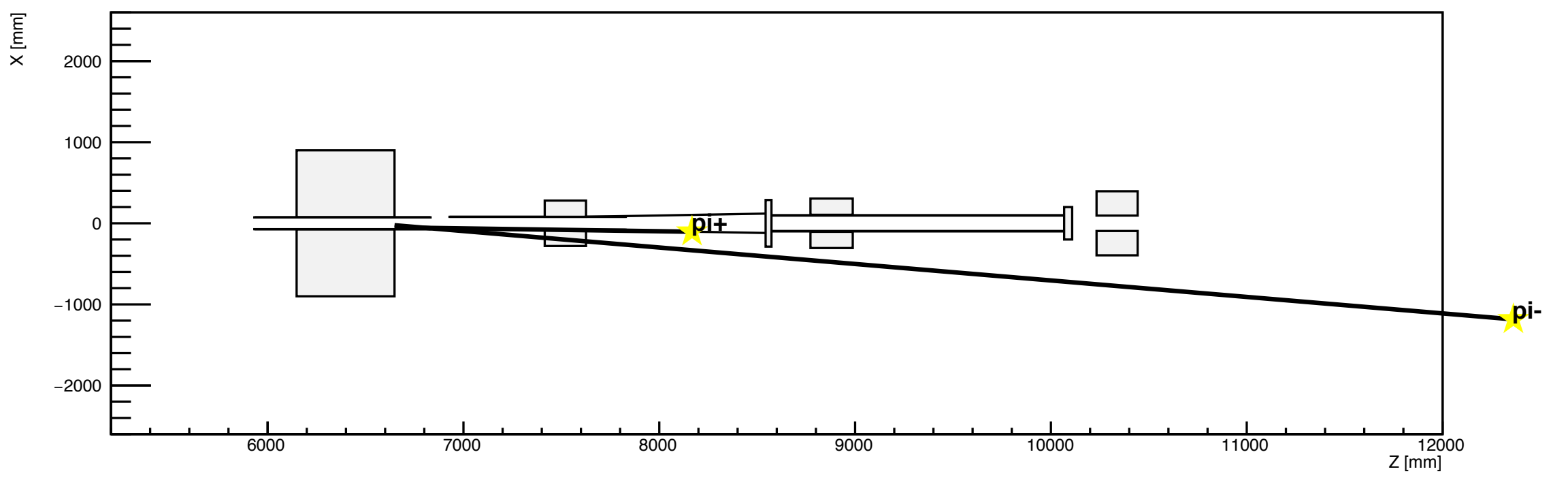

h1

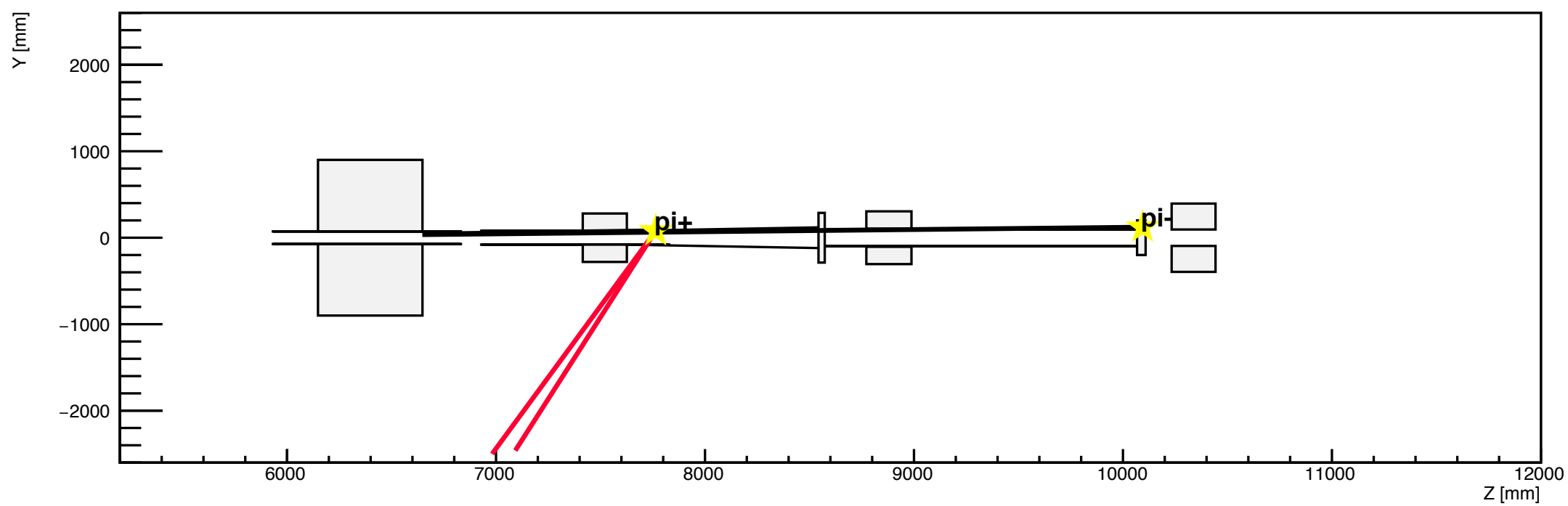

h2

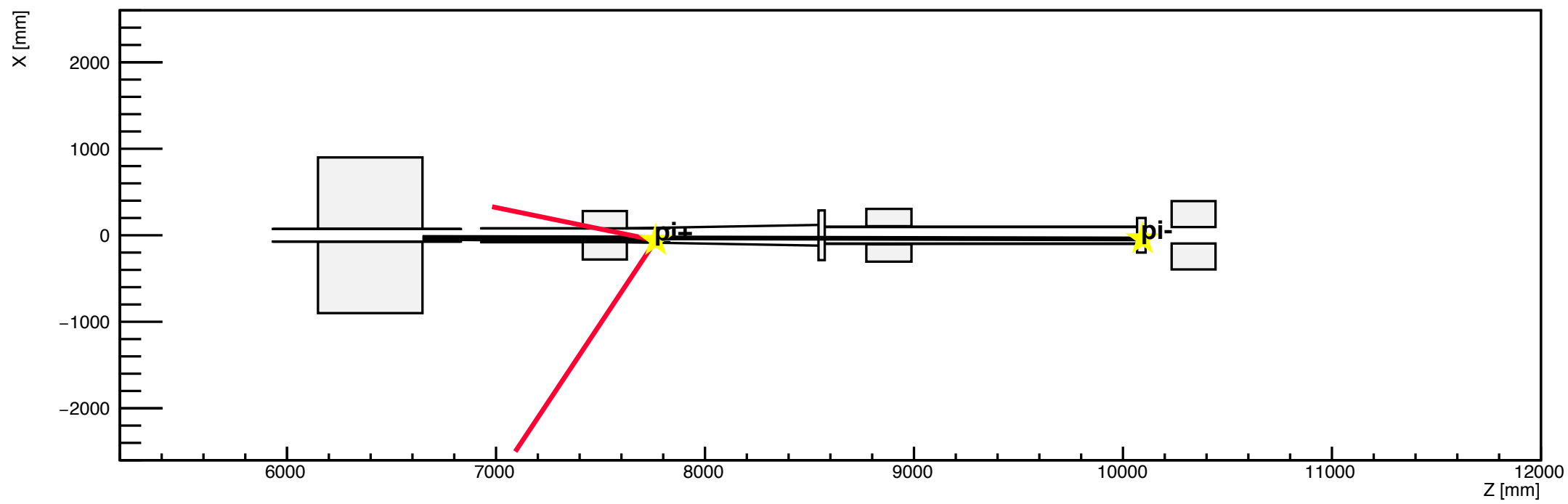

h1

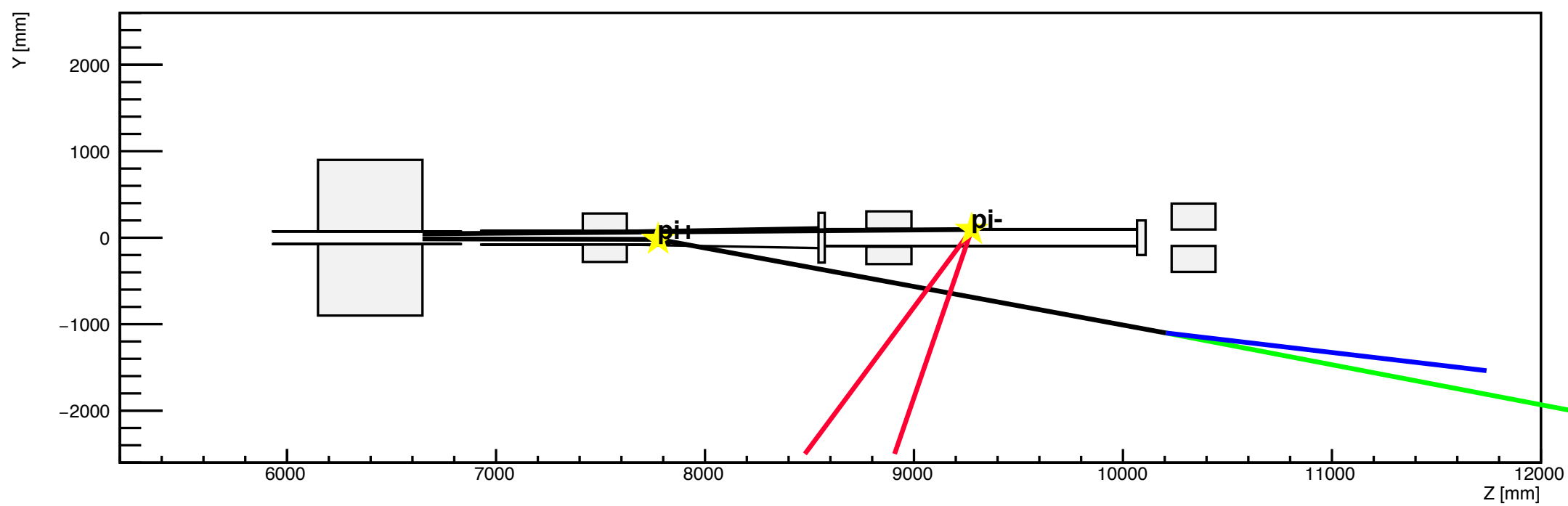

h2

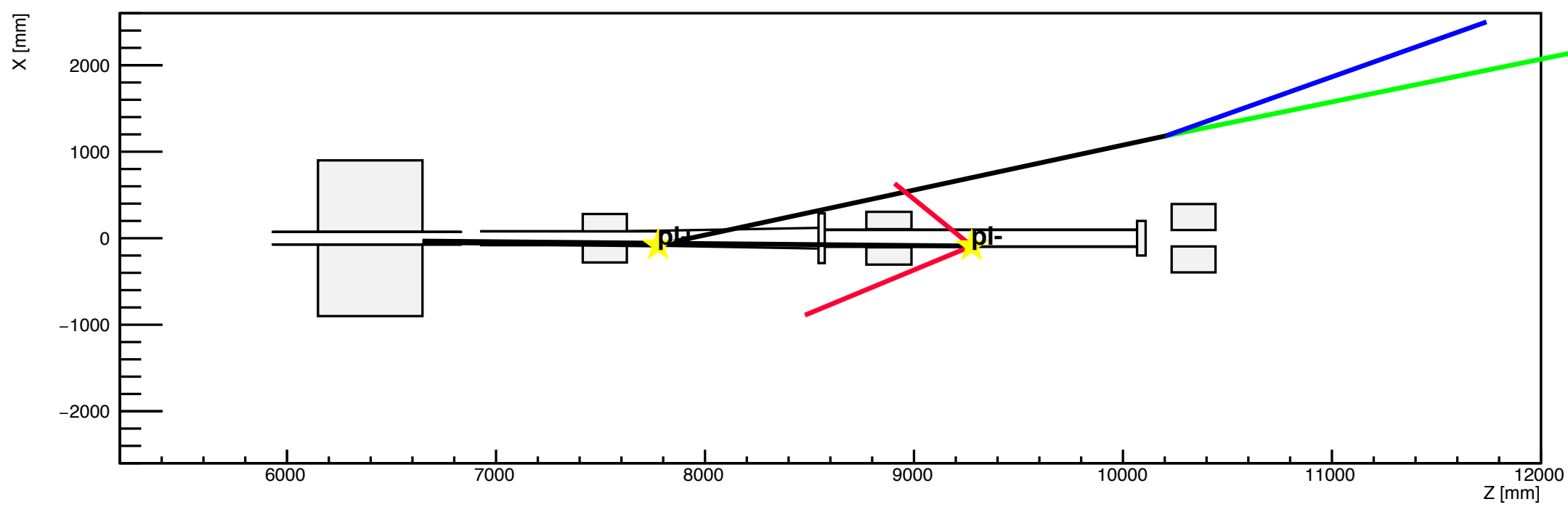

h1

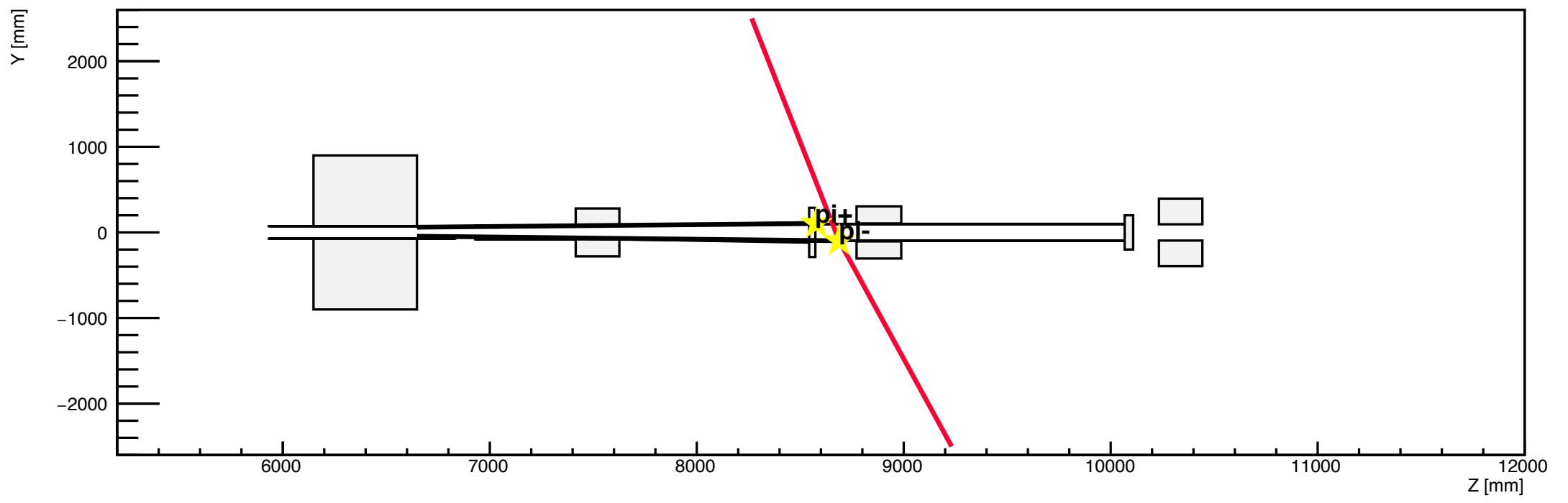

h2

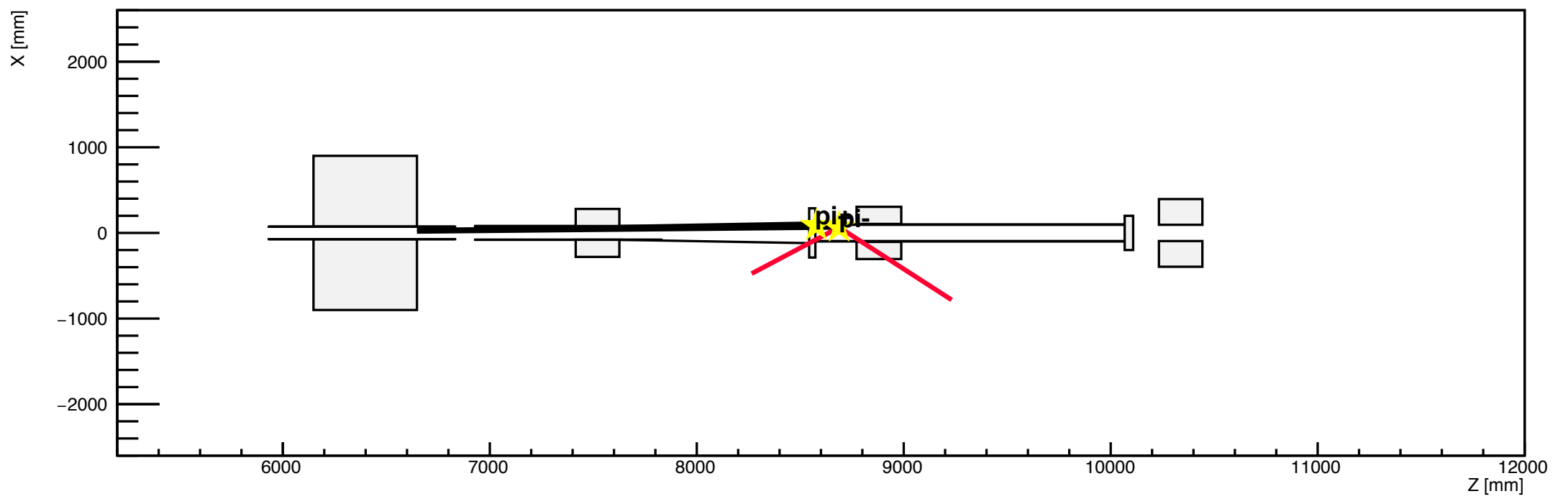

h1

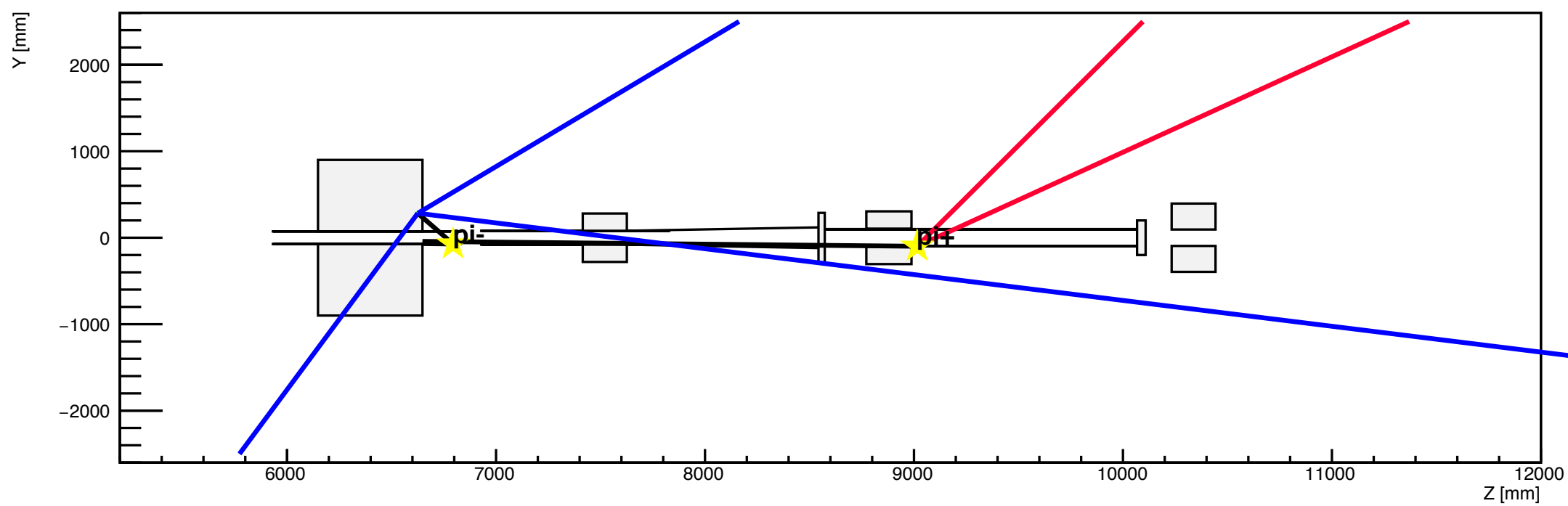

h2

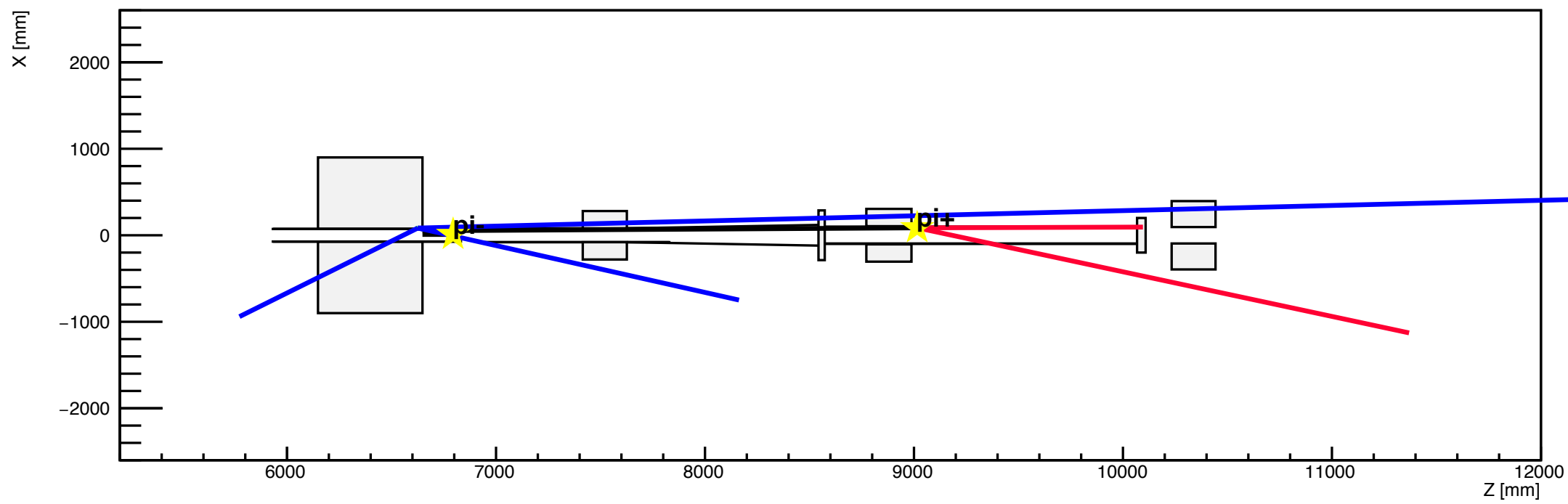

h1

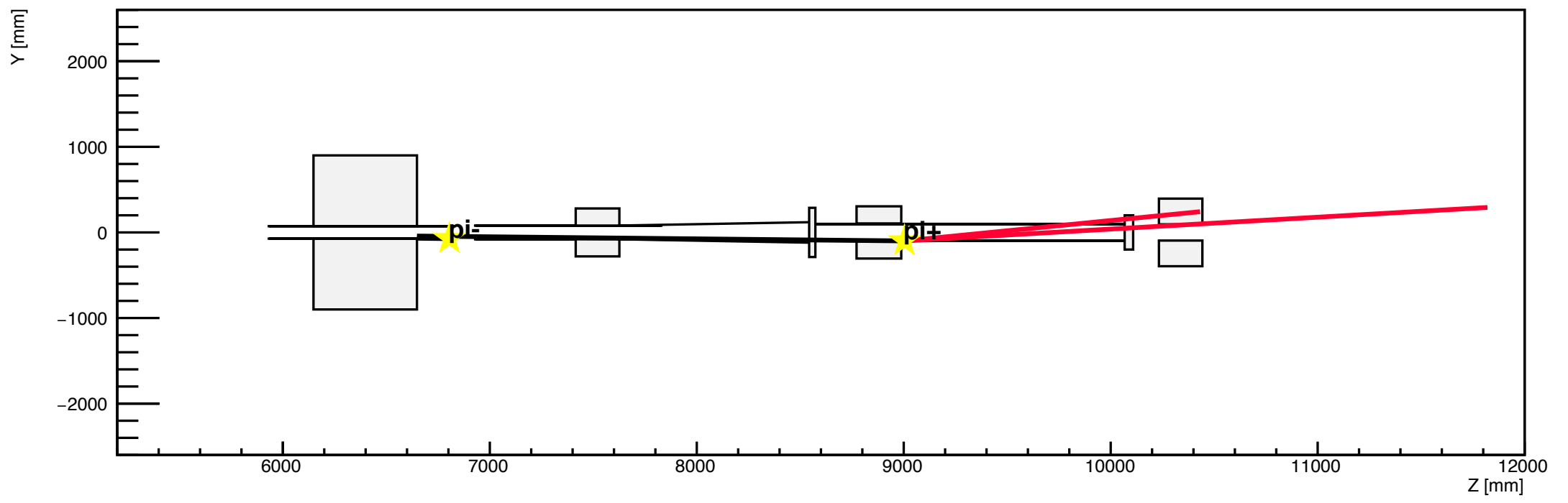

h2

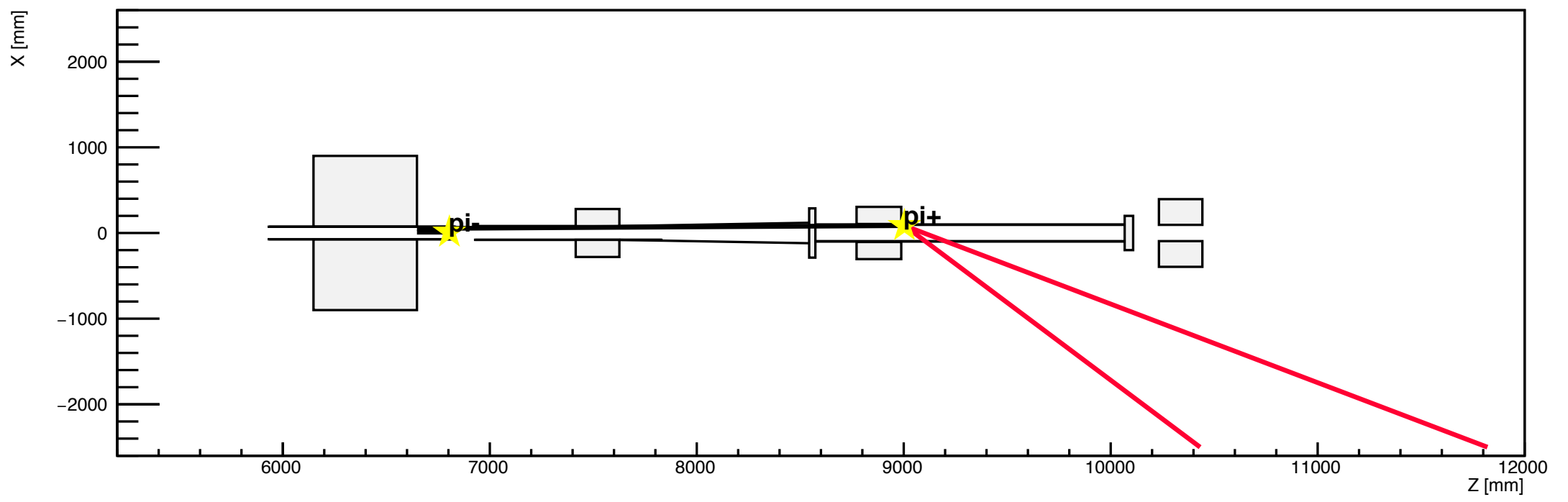

h1

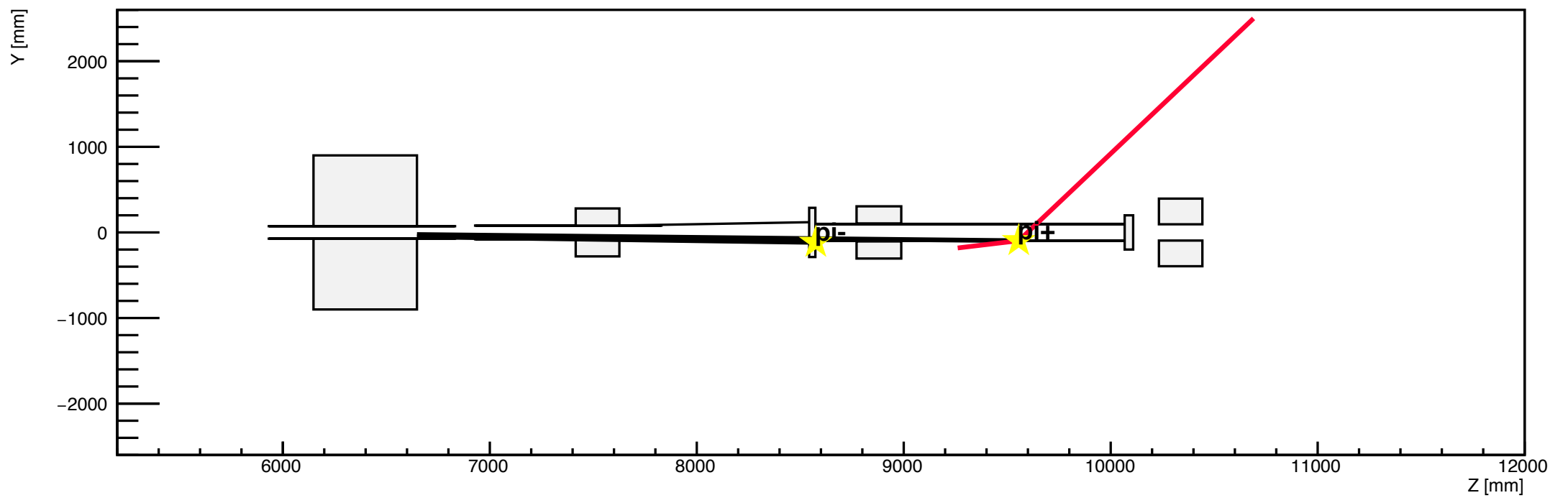

h2

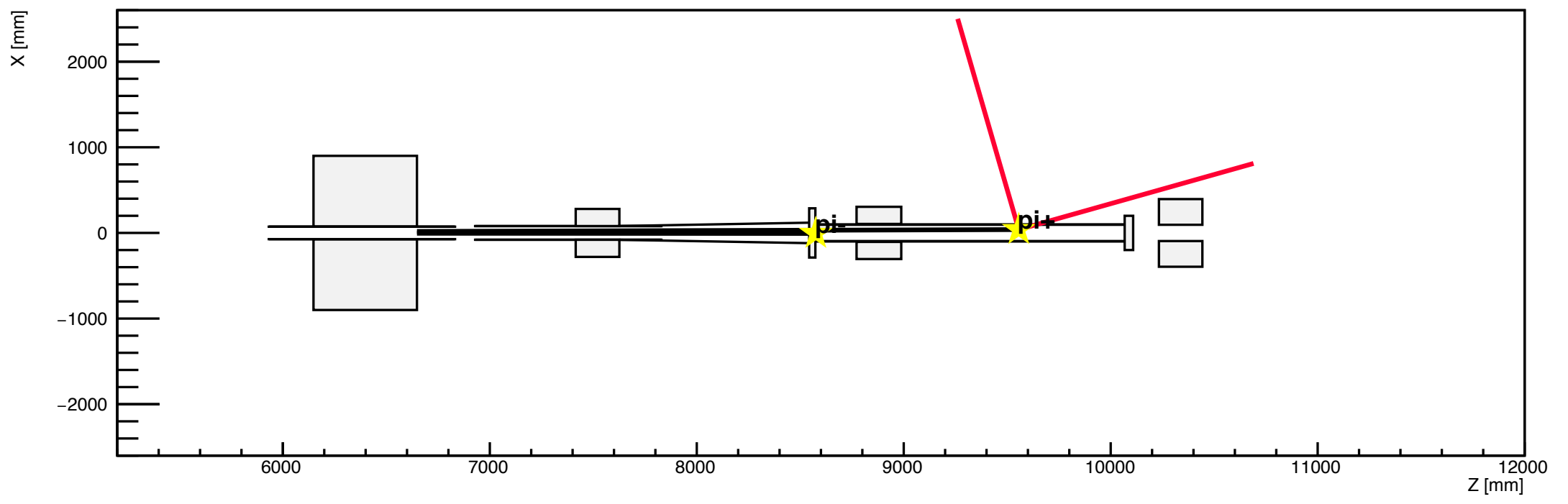

h1

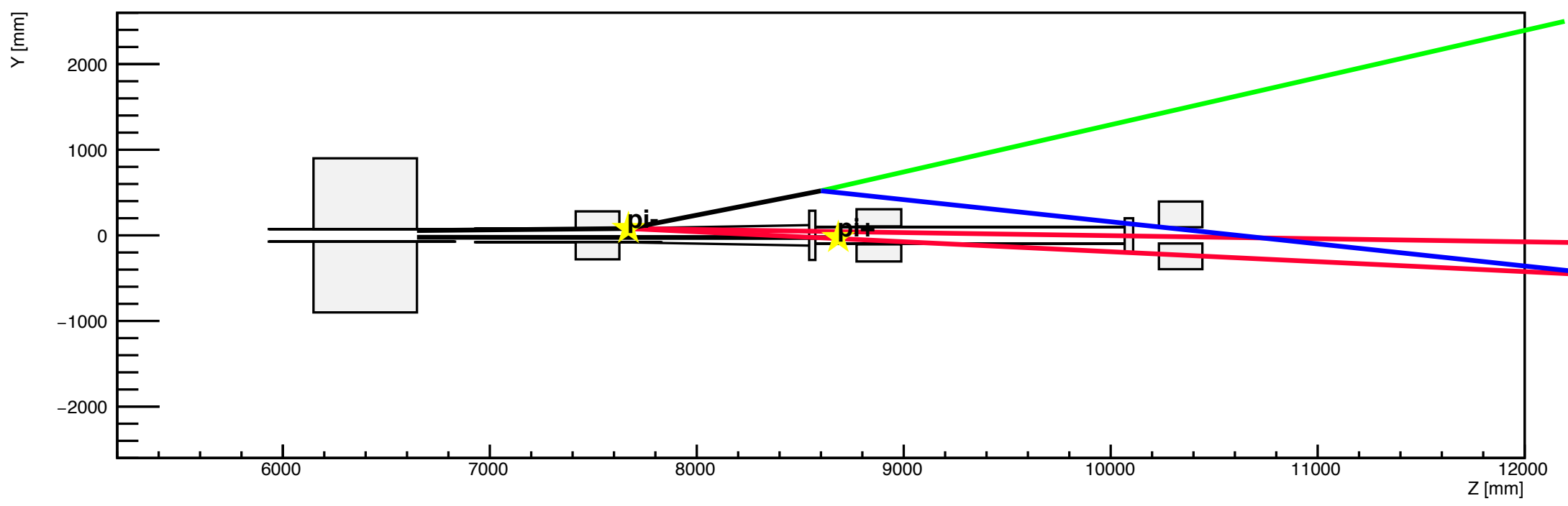

h2

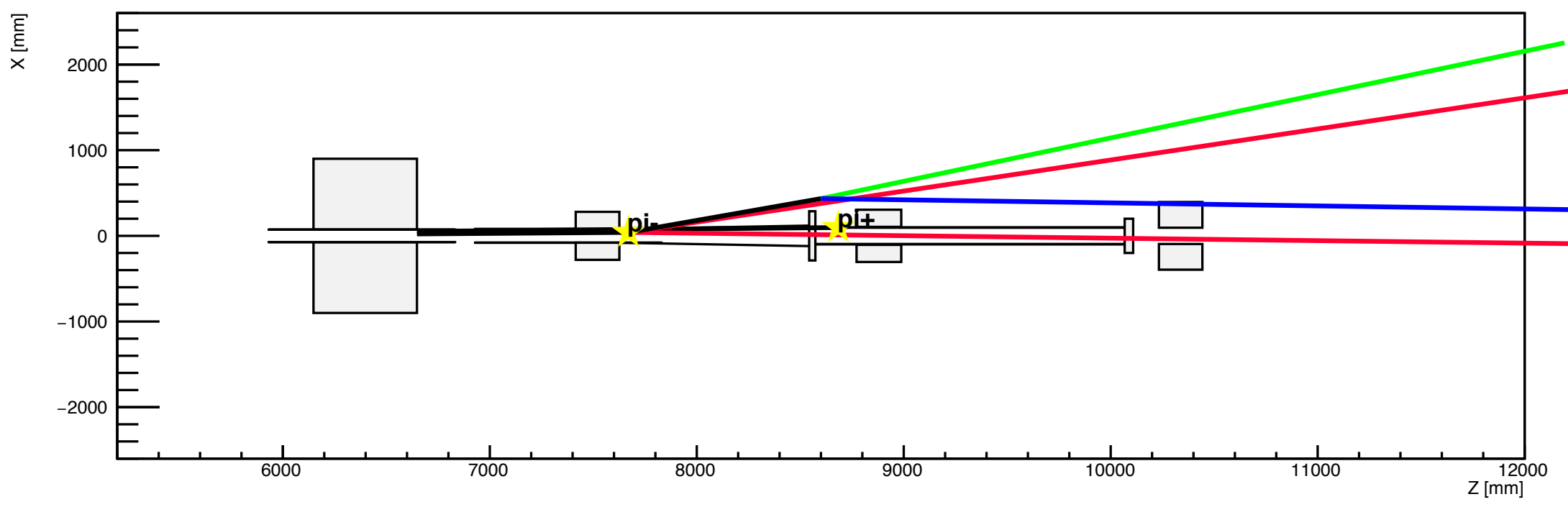

h1

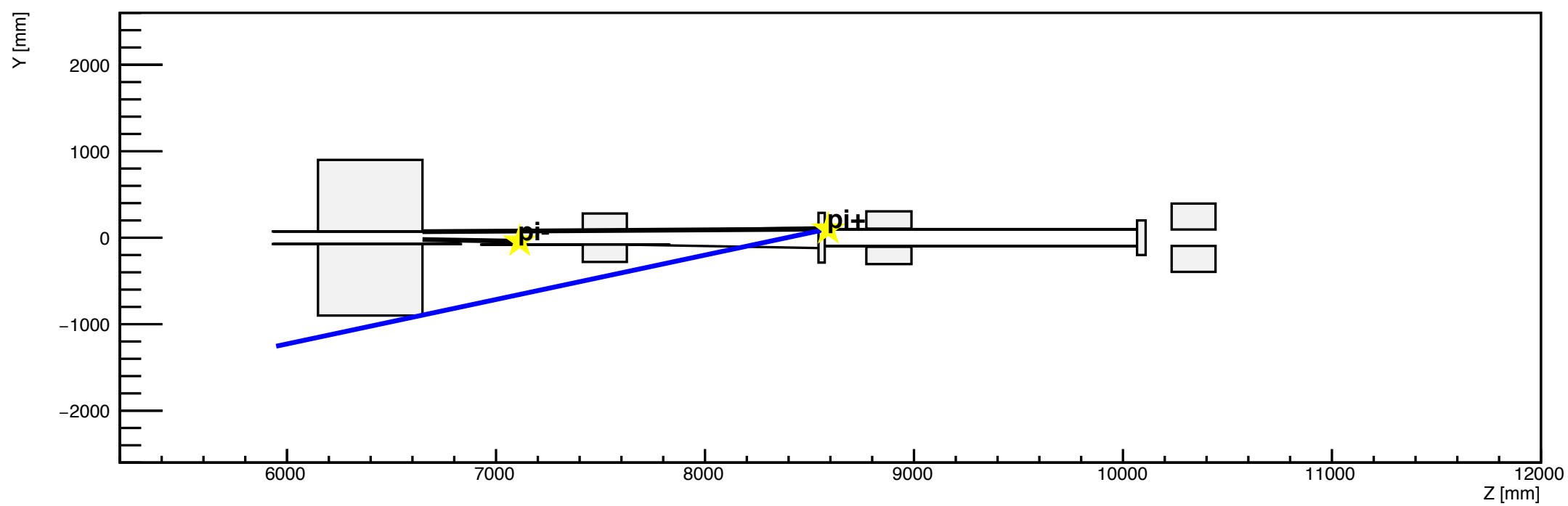

h2

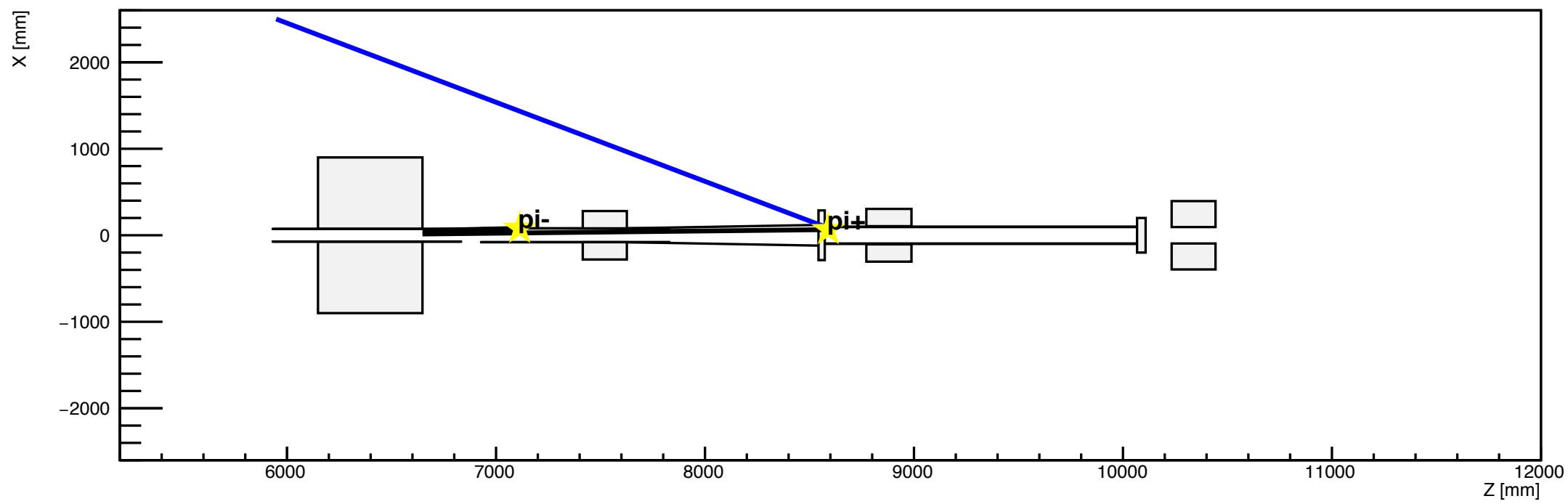

h1

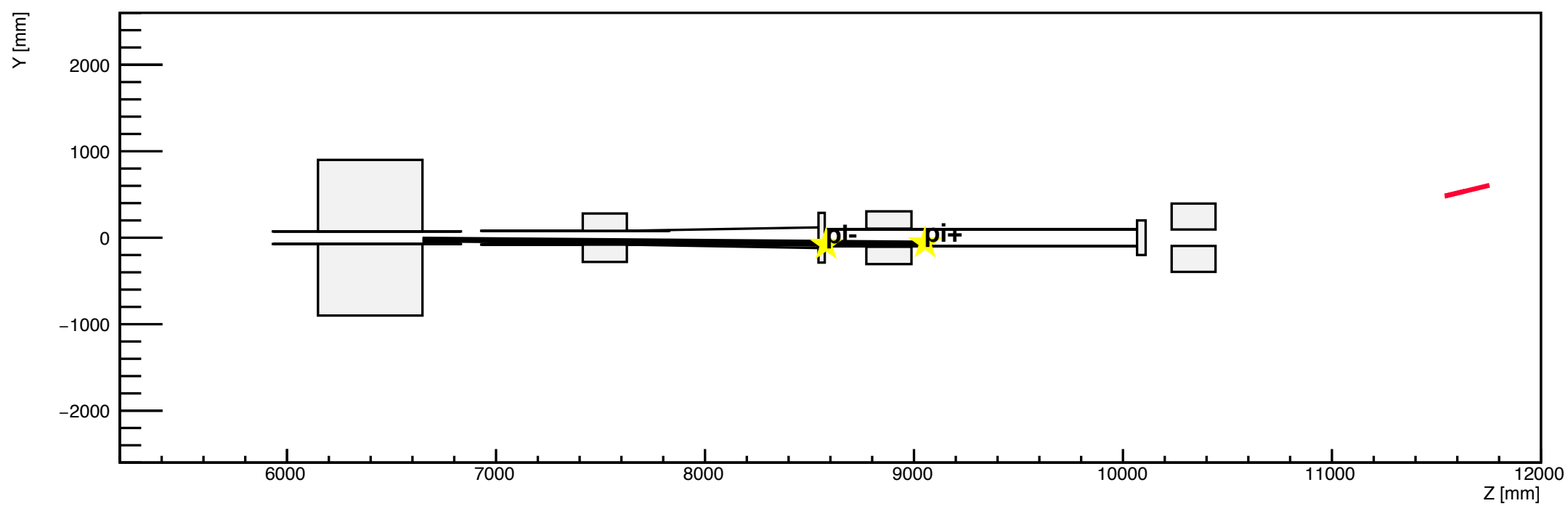

h2

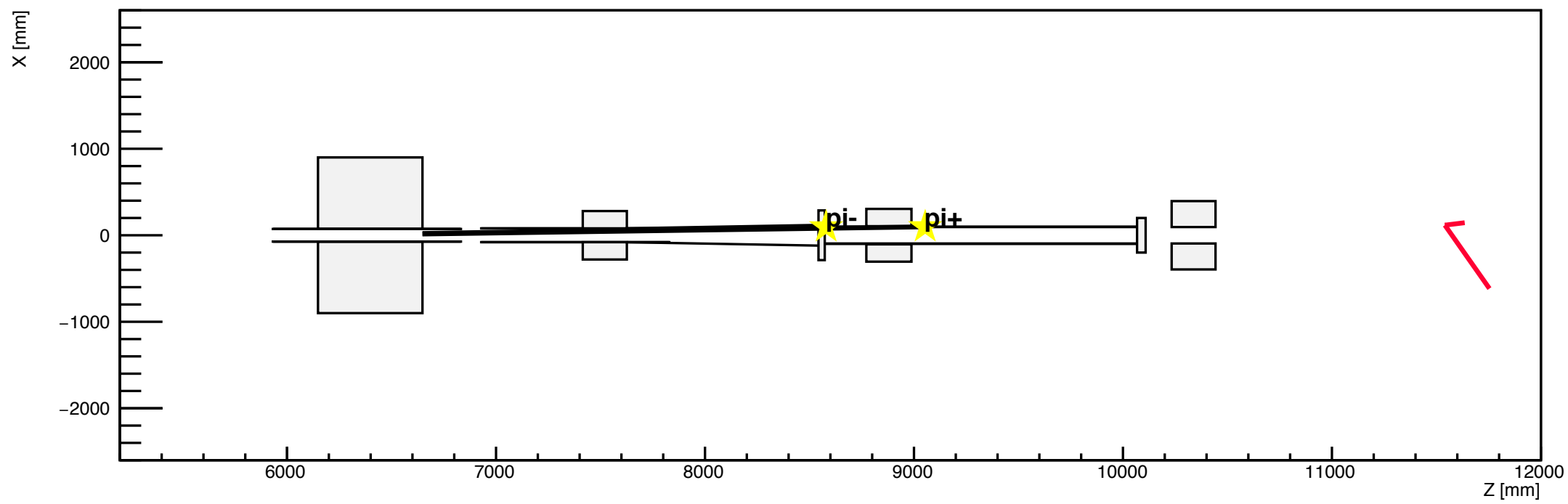

h1

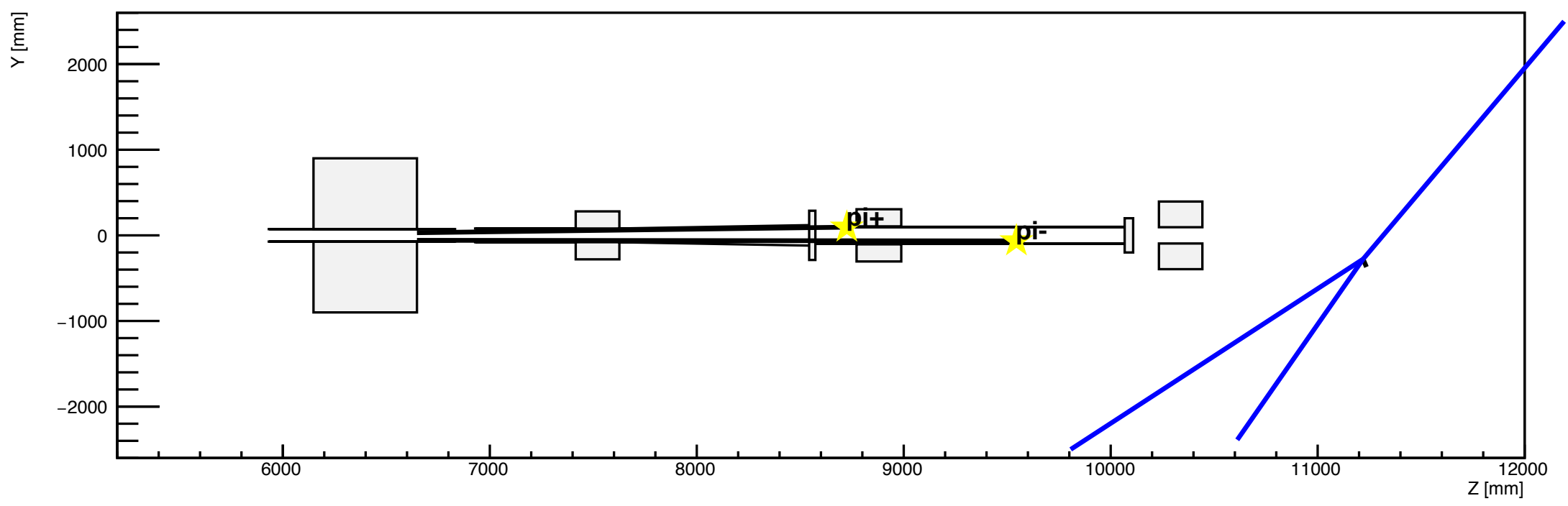

h2

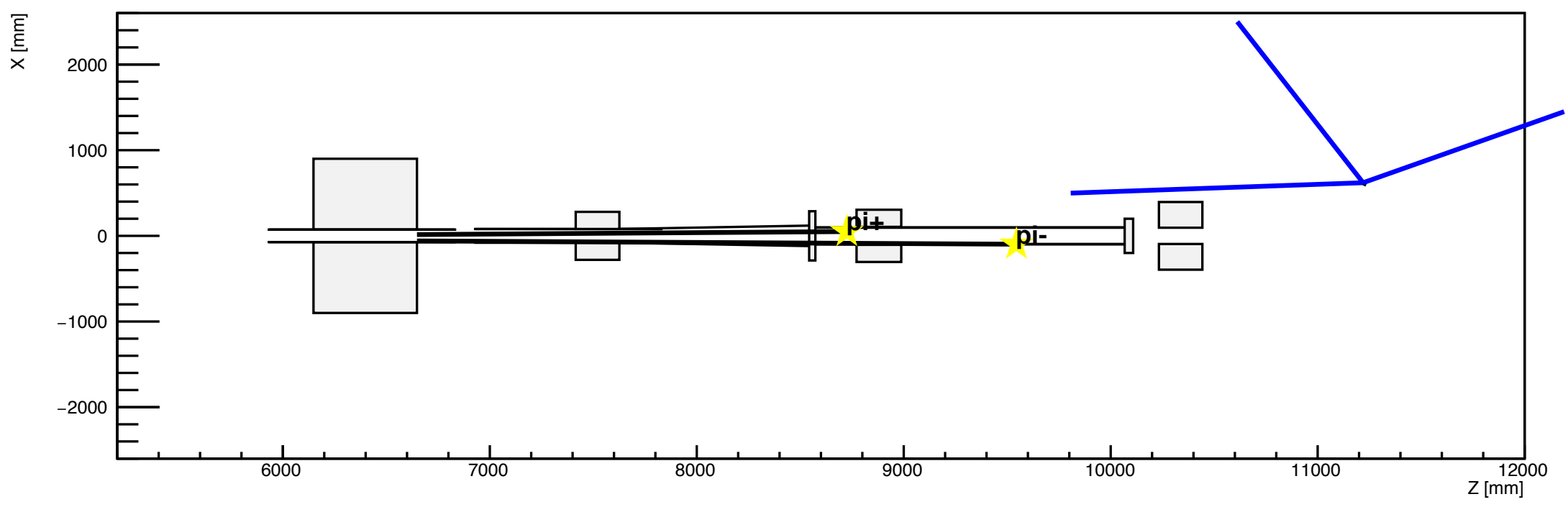

h1

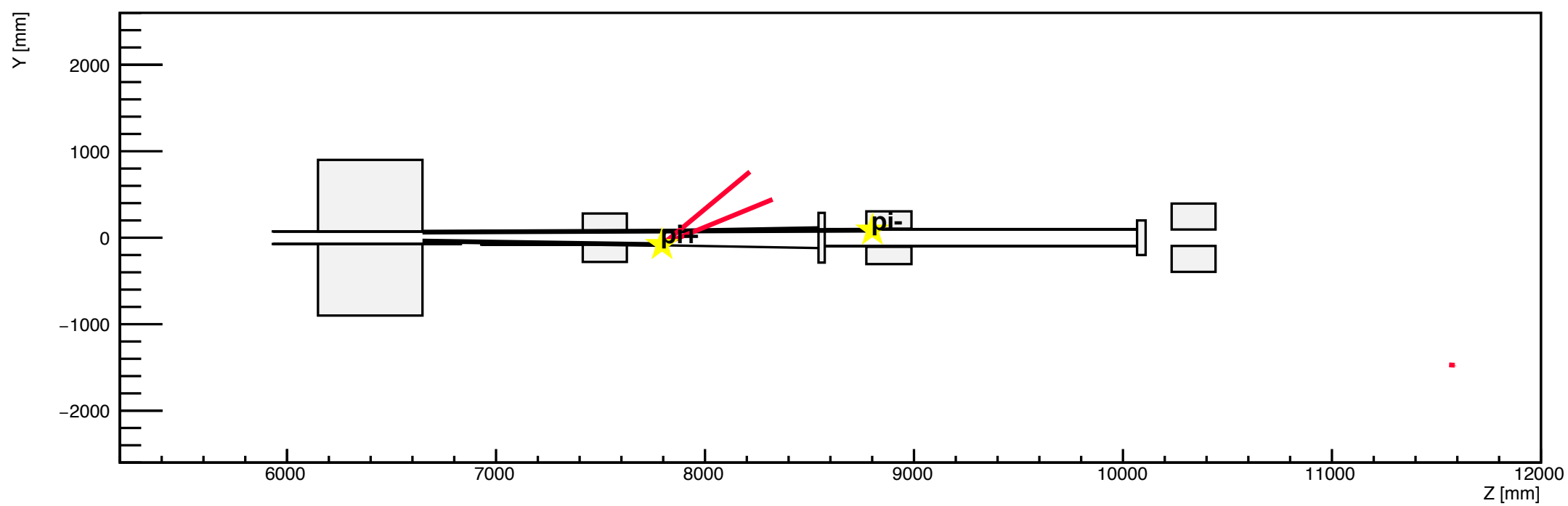

h2

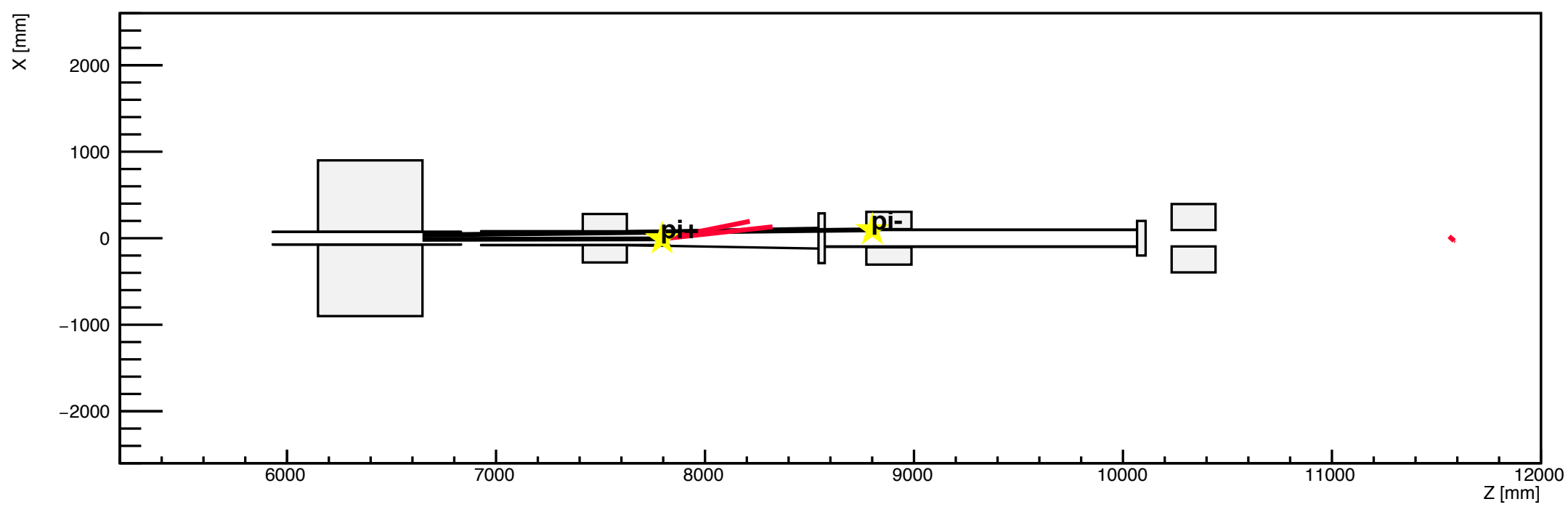

h1

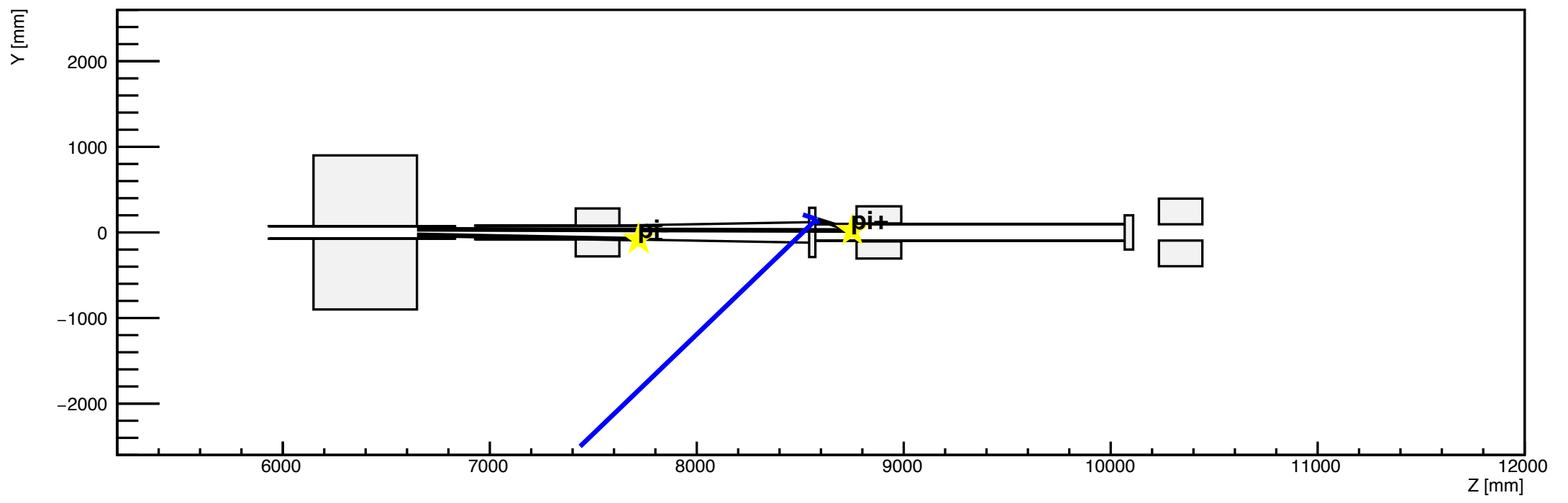

h2

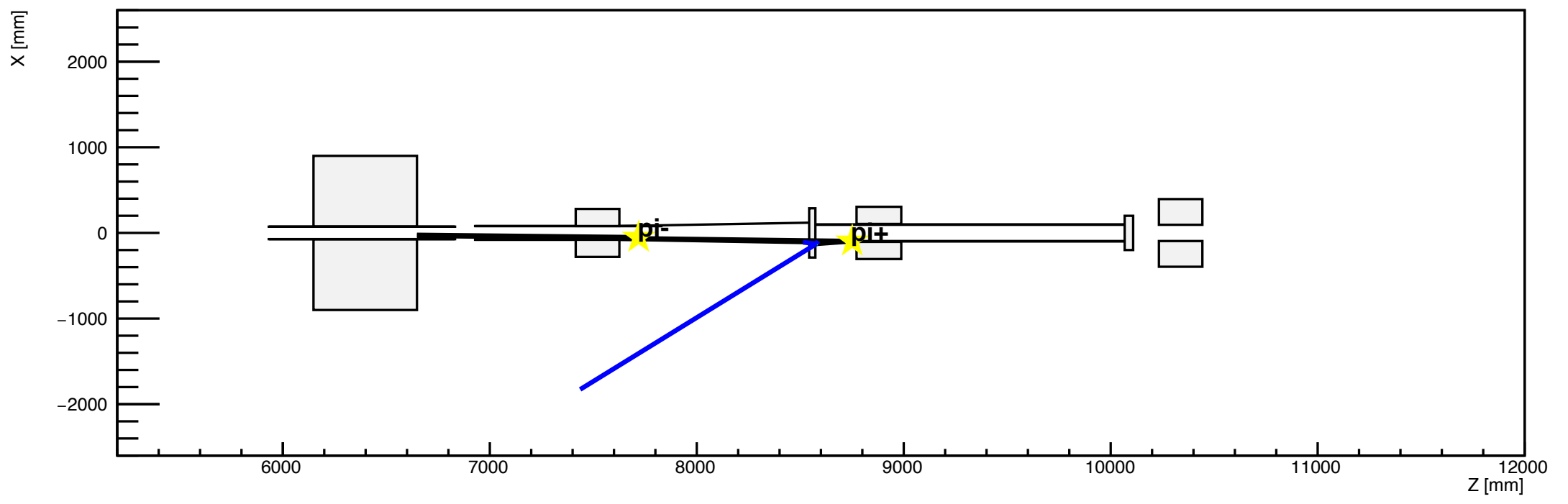

h1

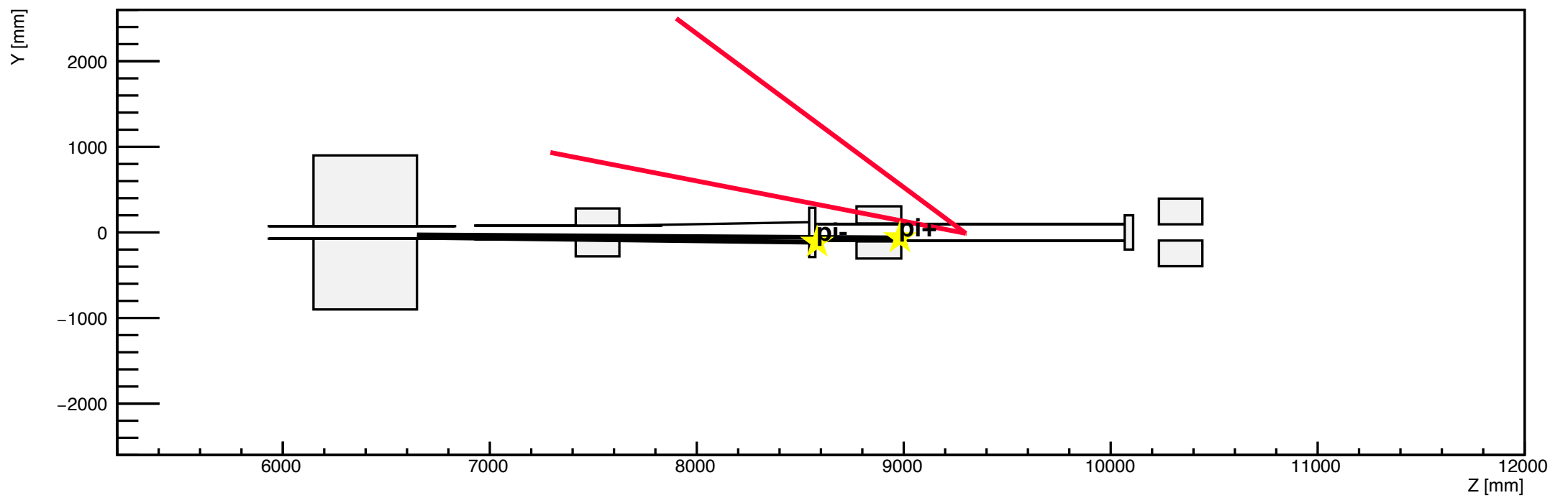

h2

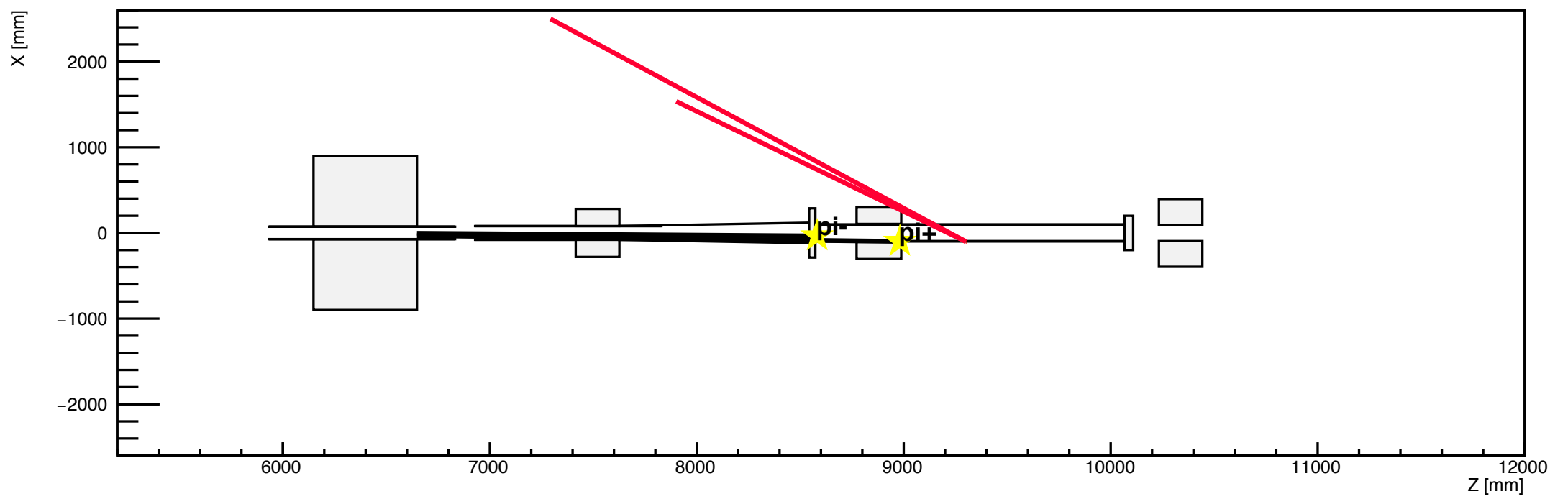

h1

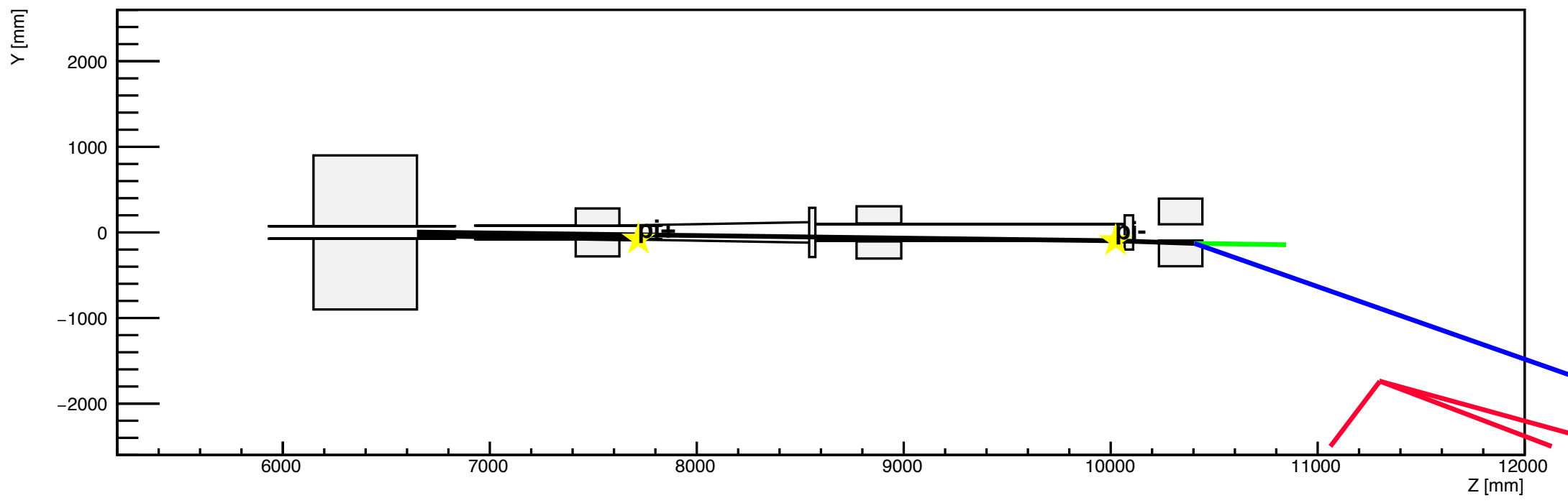

h2

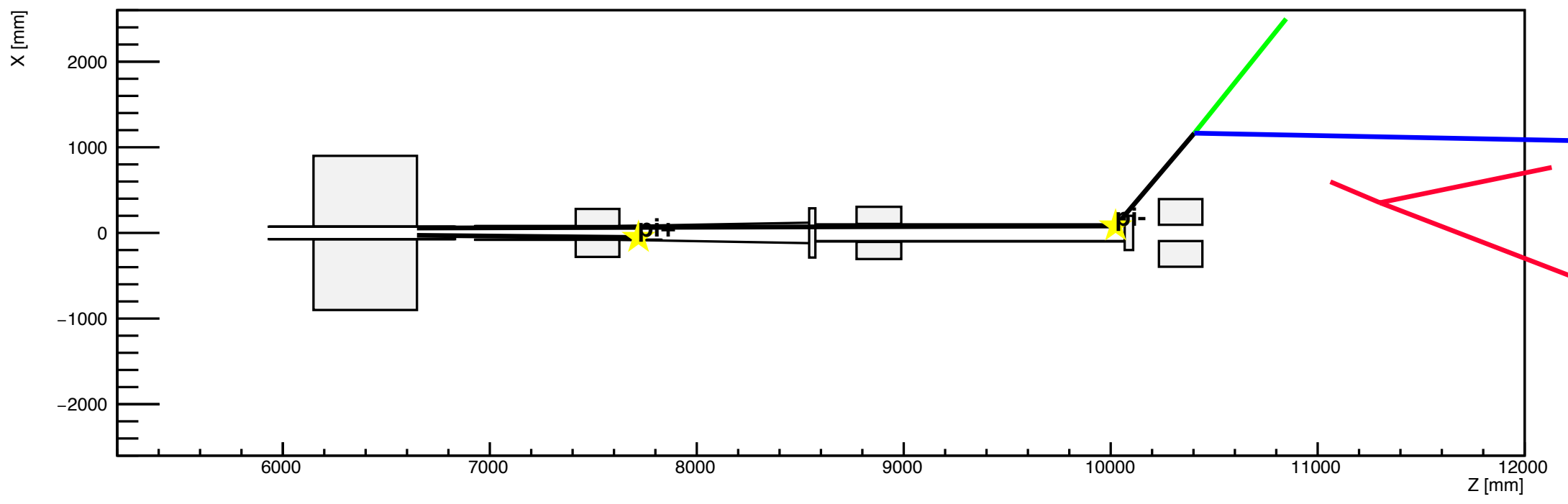

h1

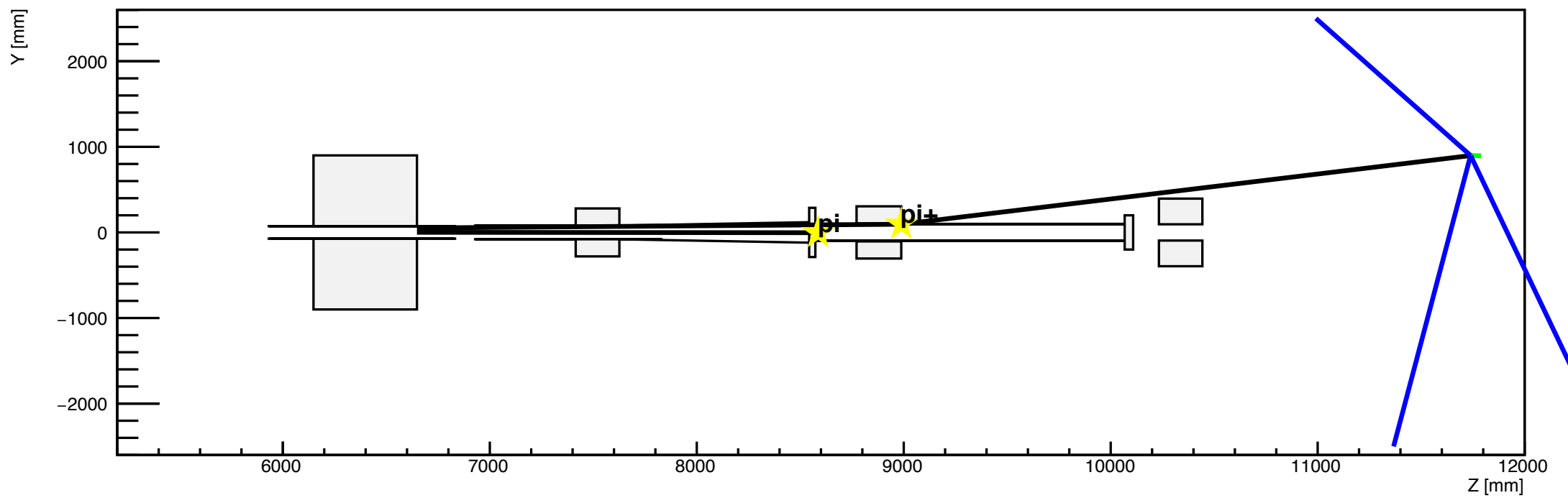

h2

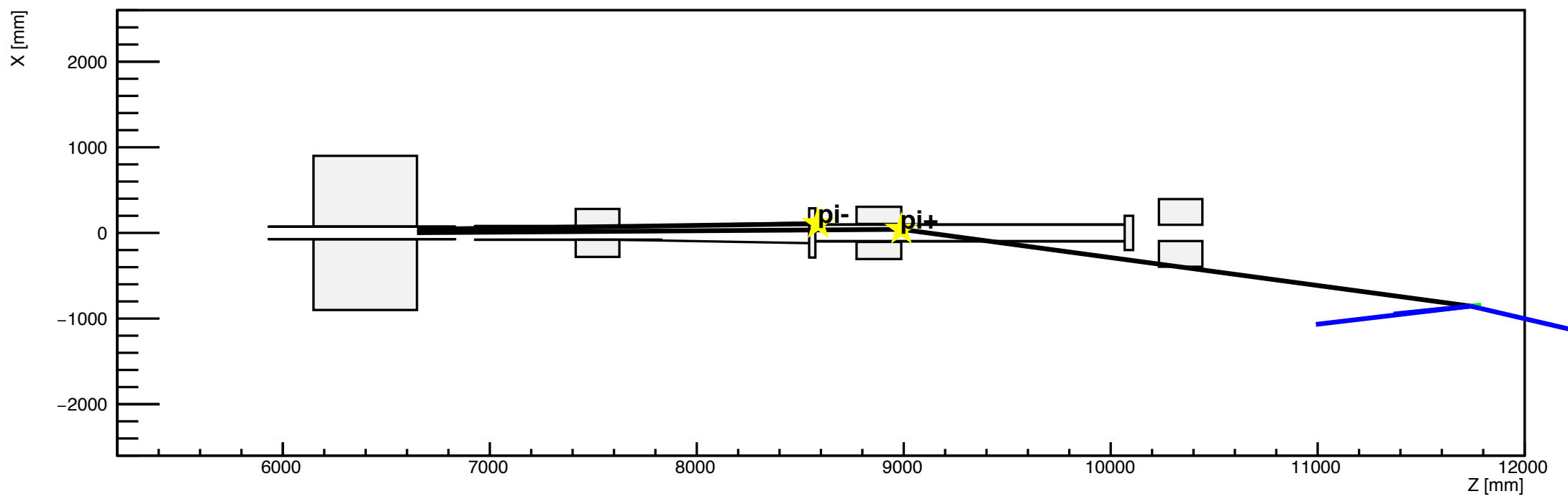

h1

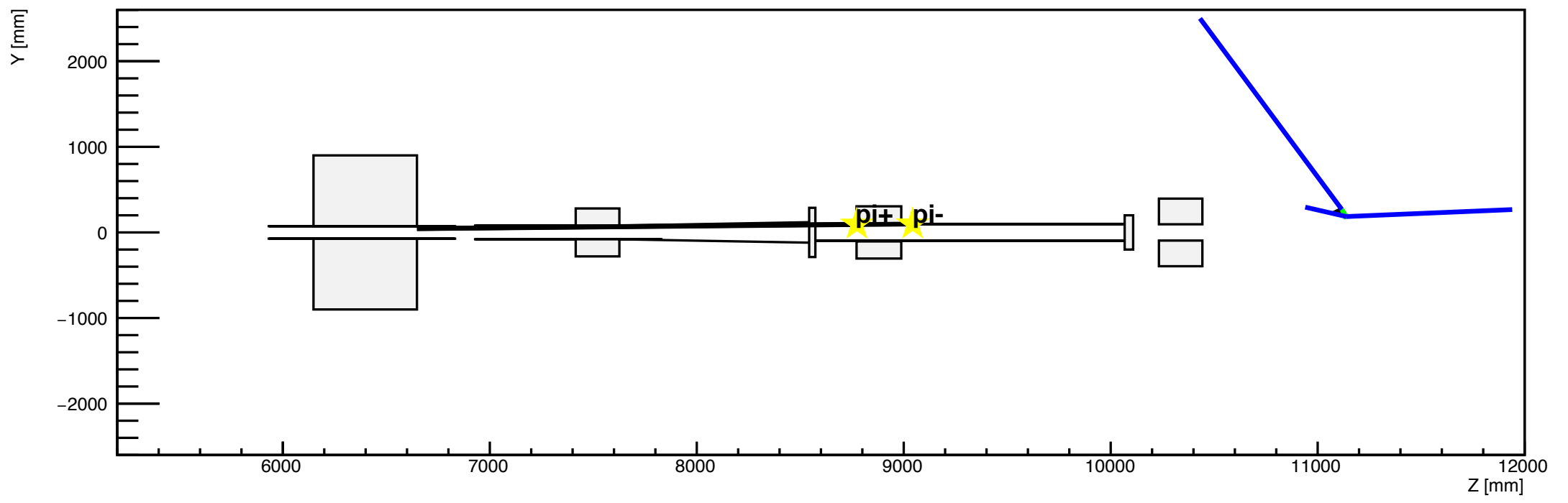

h2

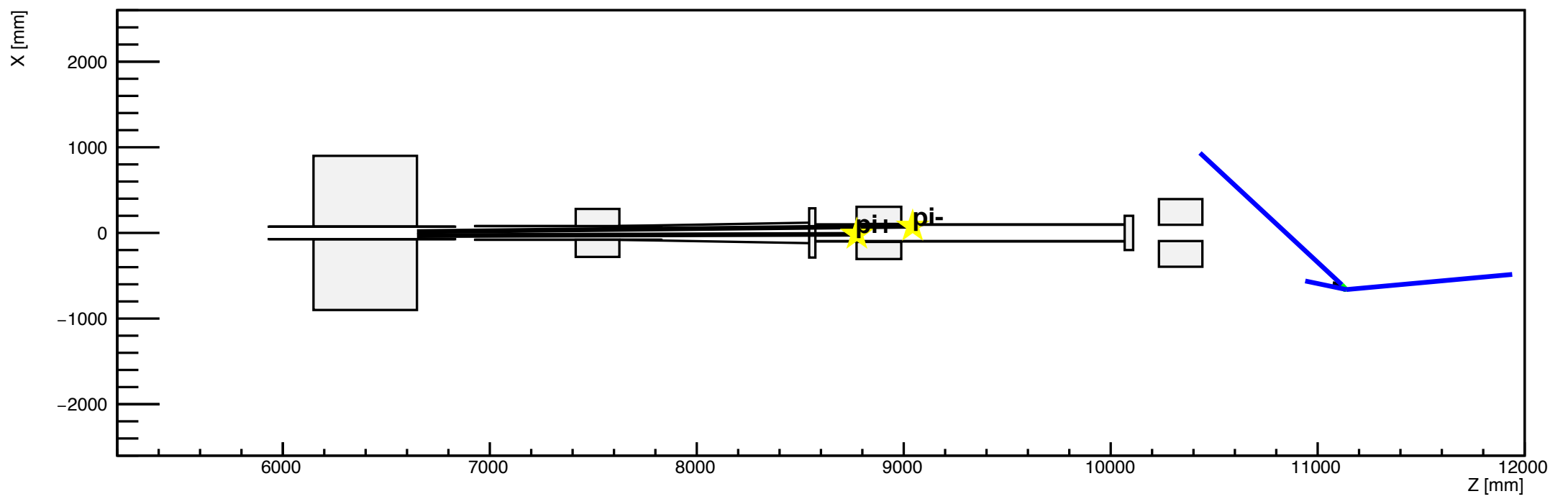

h1

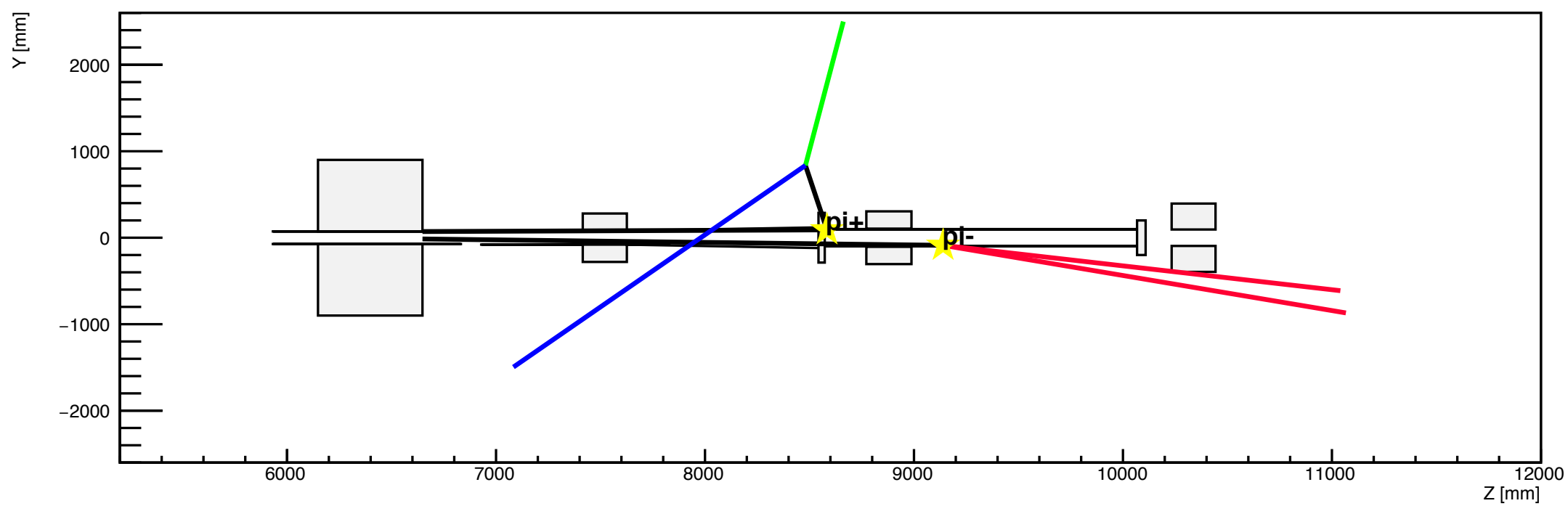

h2

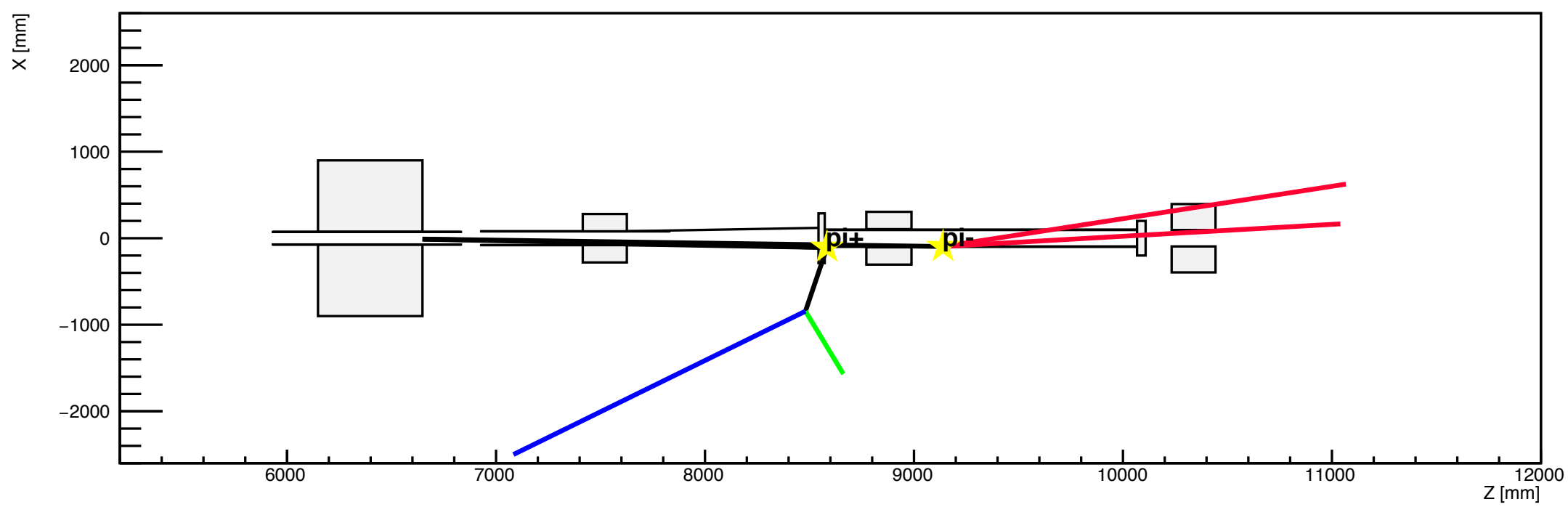

h1

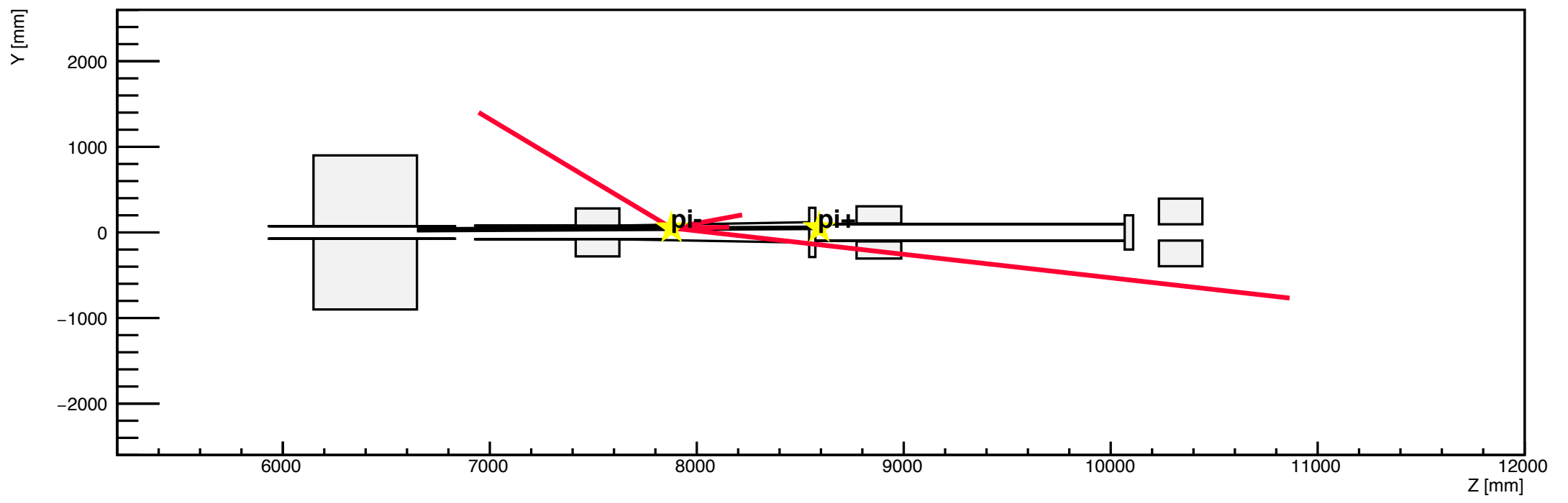

h2

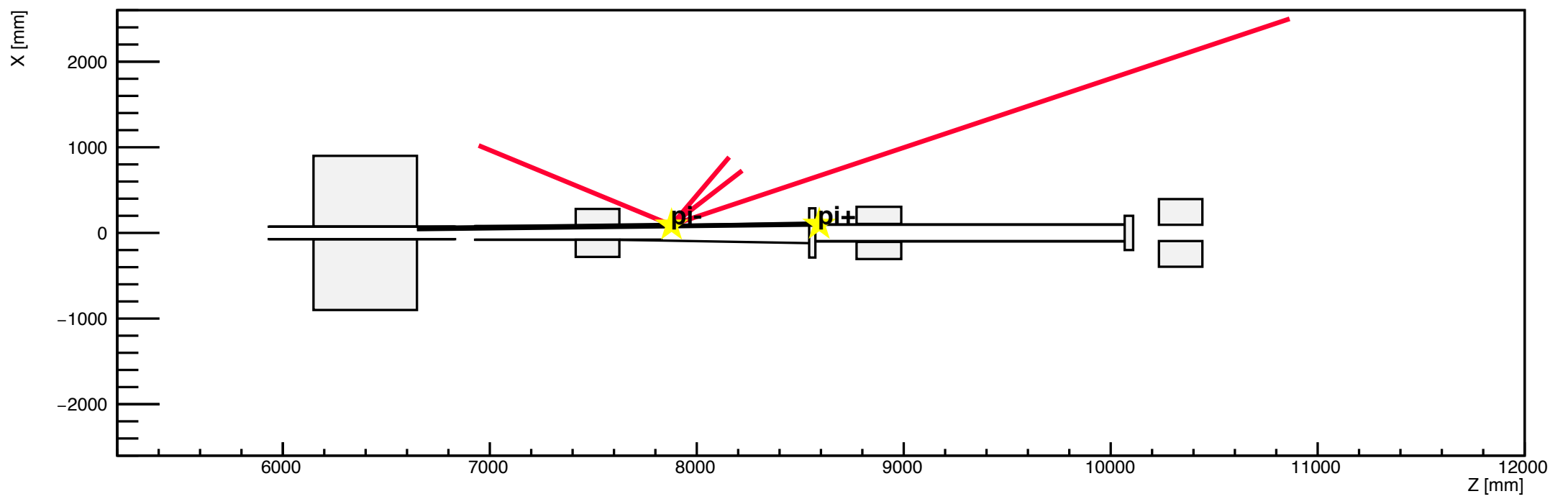

h1

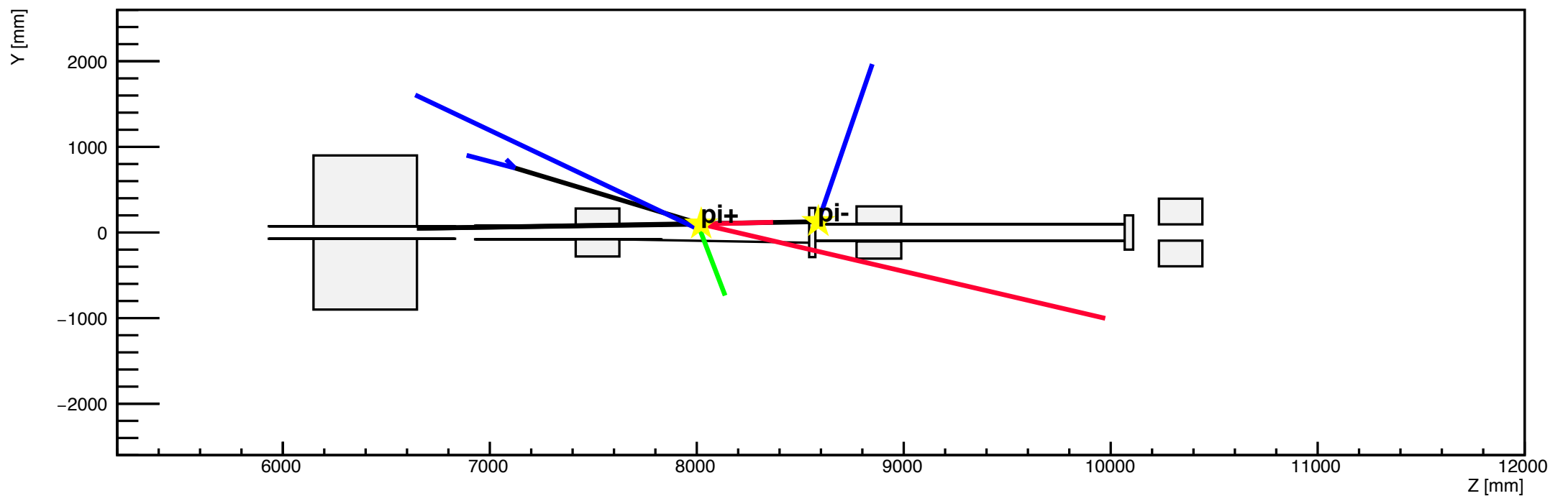

h2

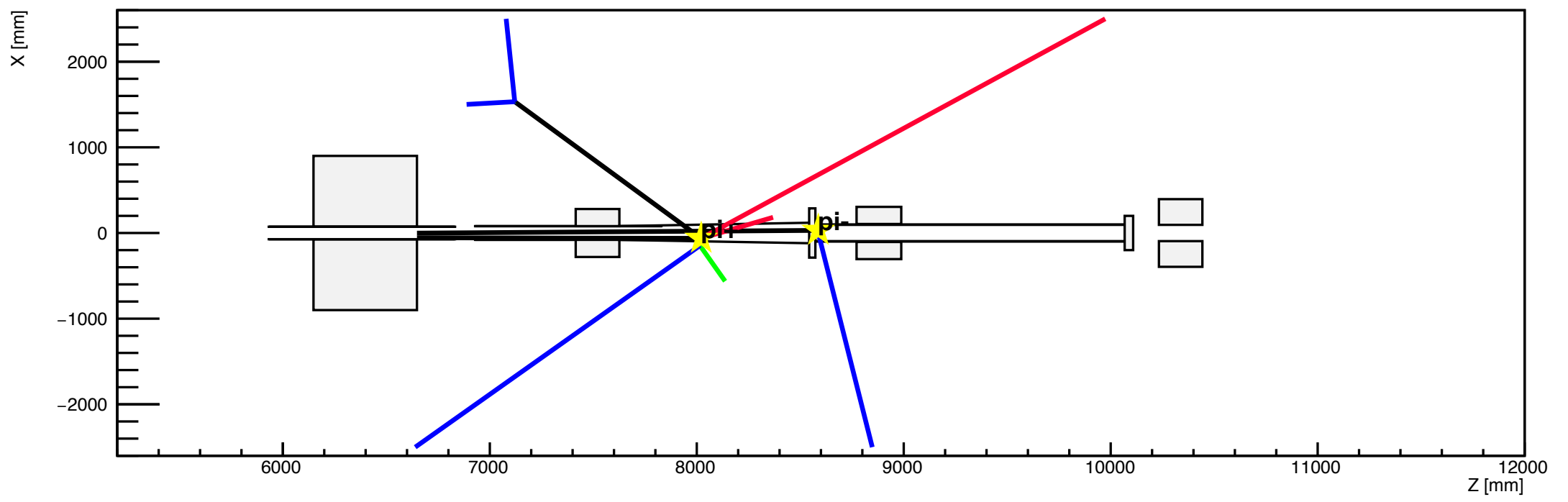

h1

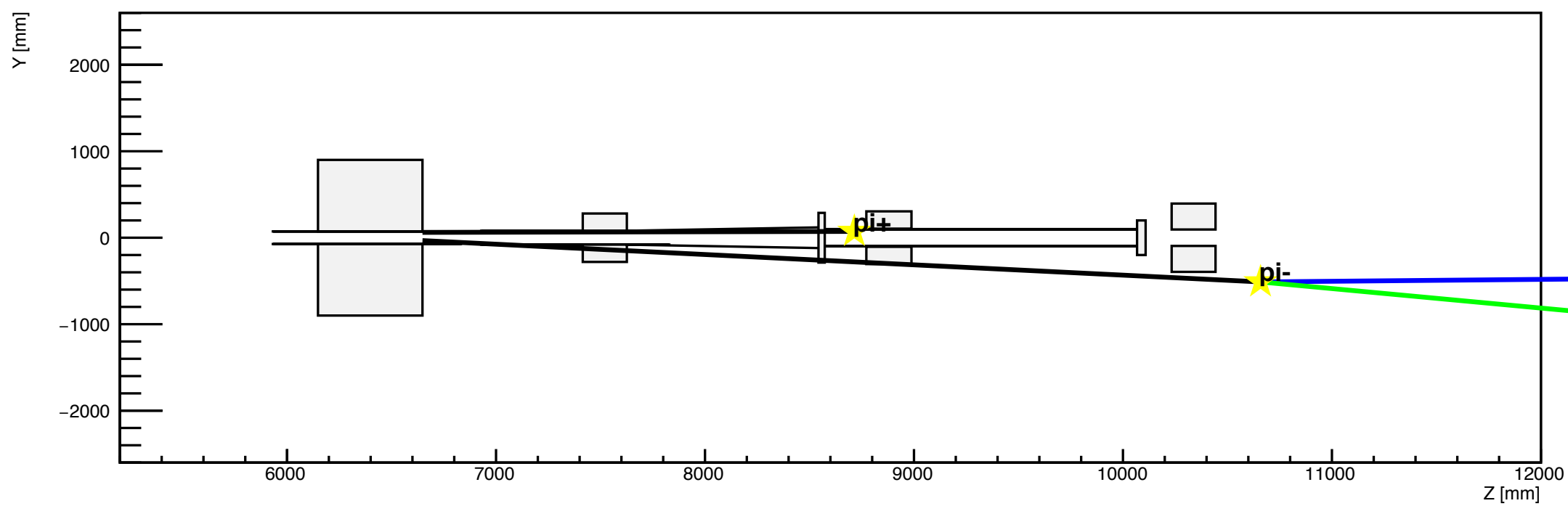

h2

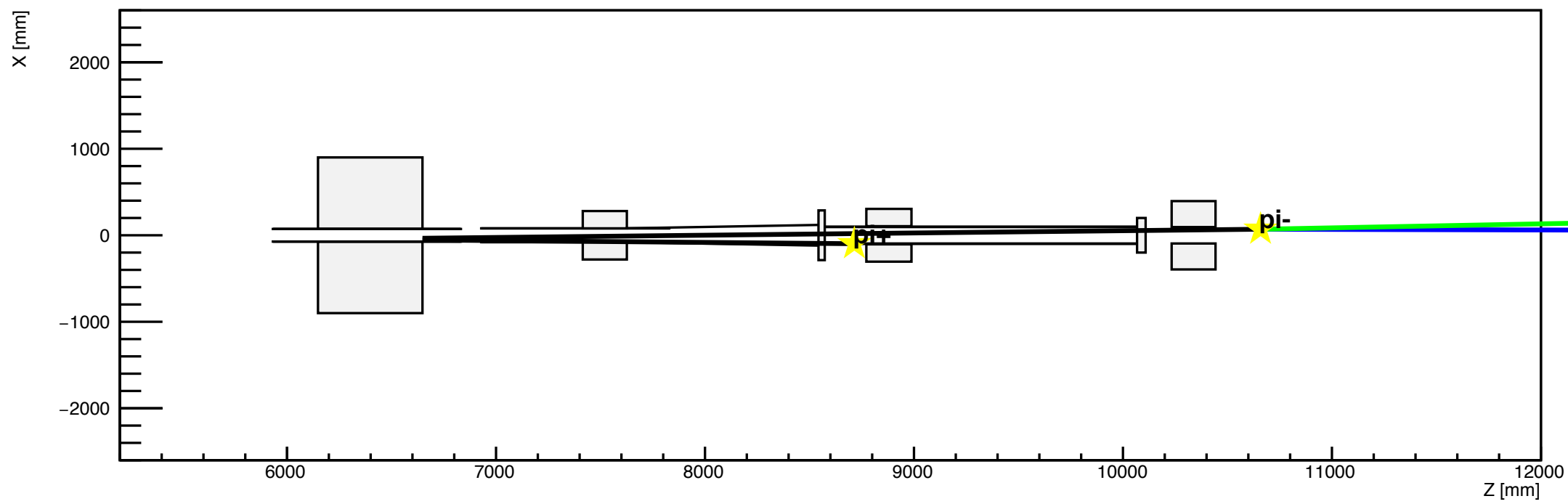

h1

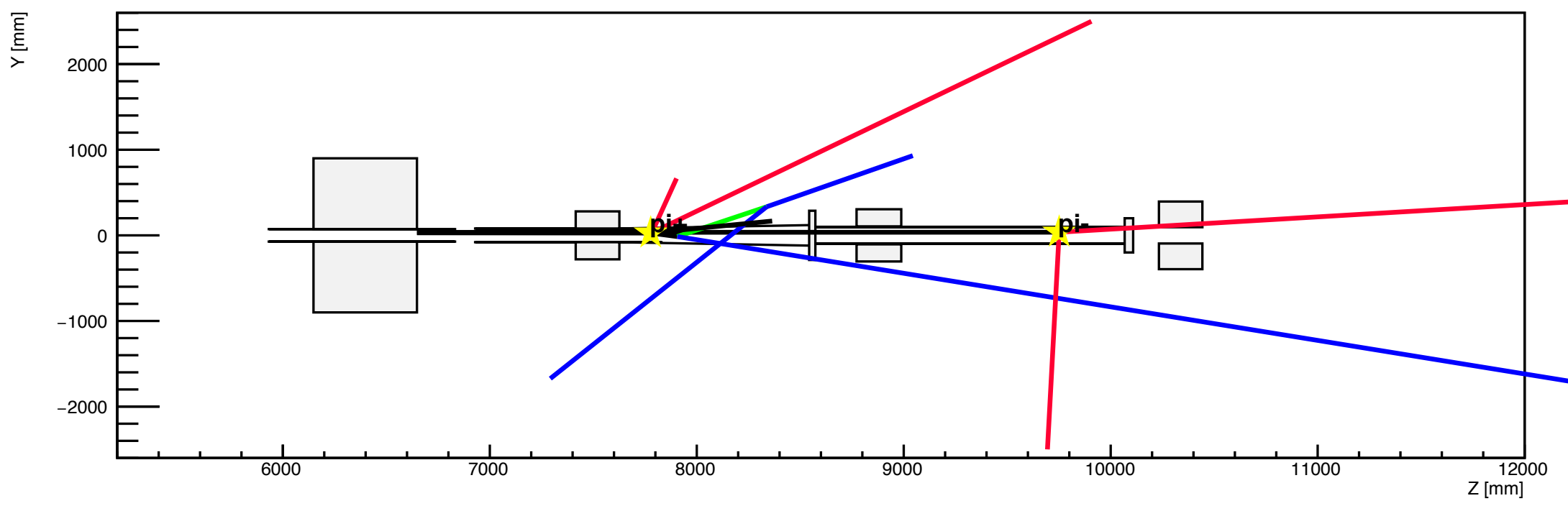

h2

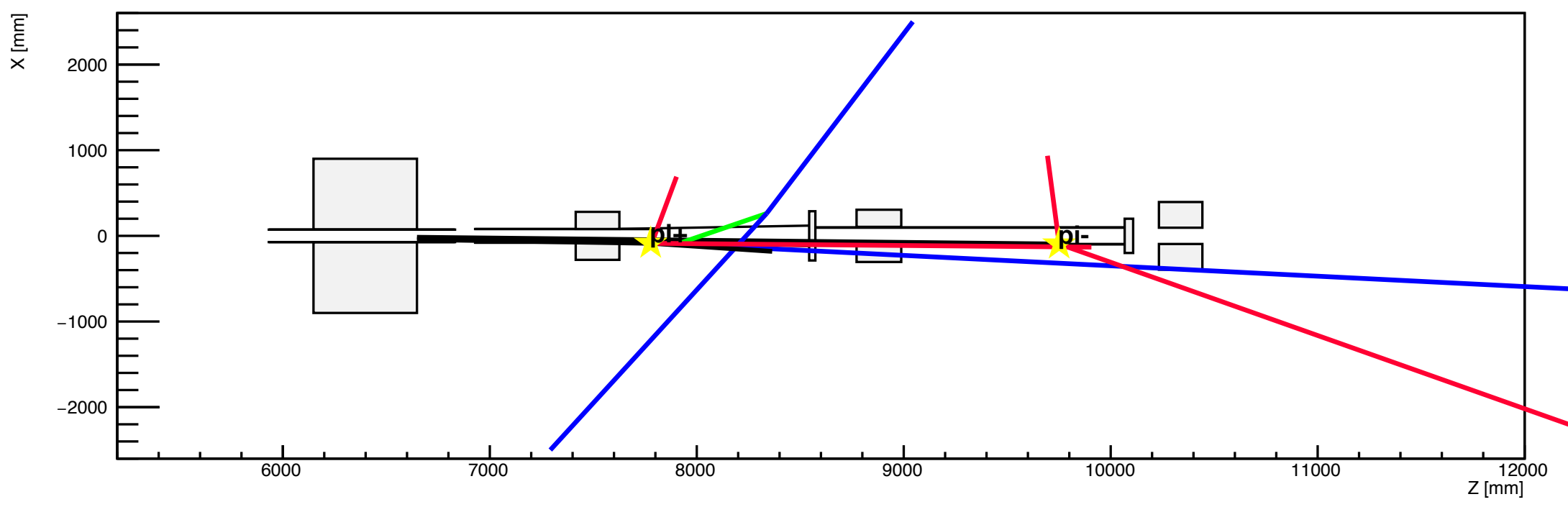

h1

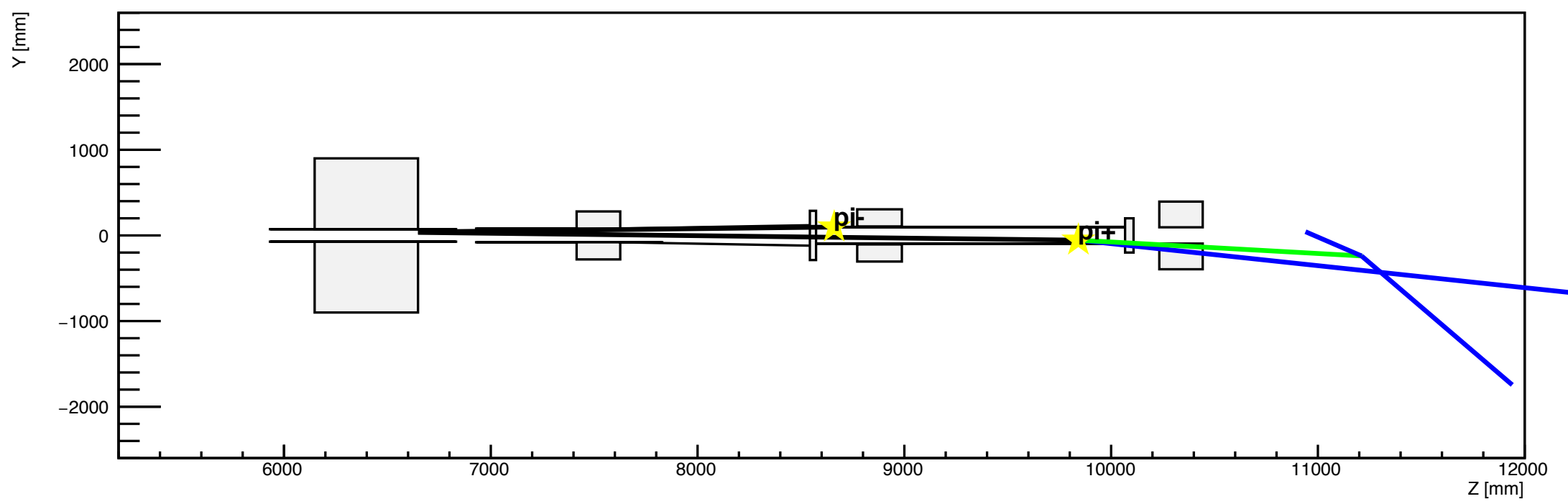

h2

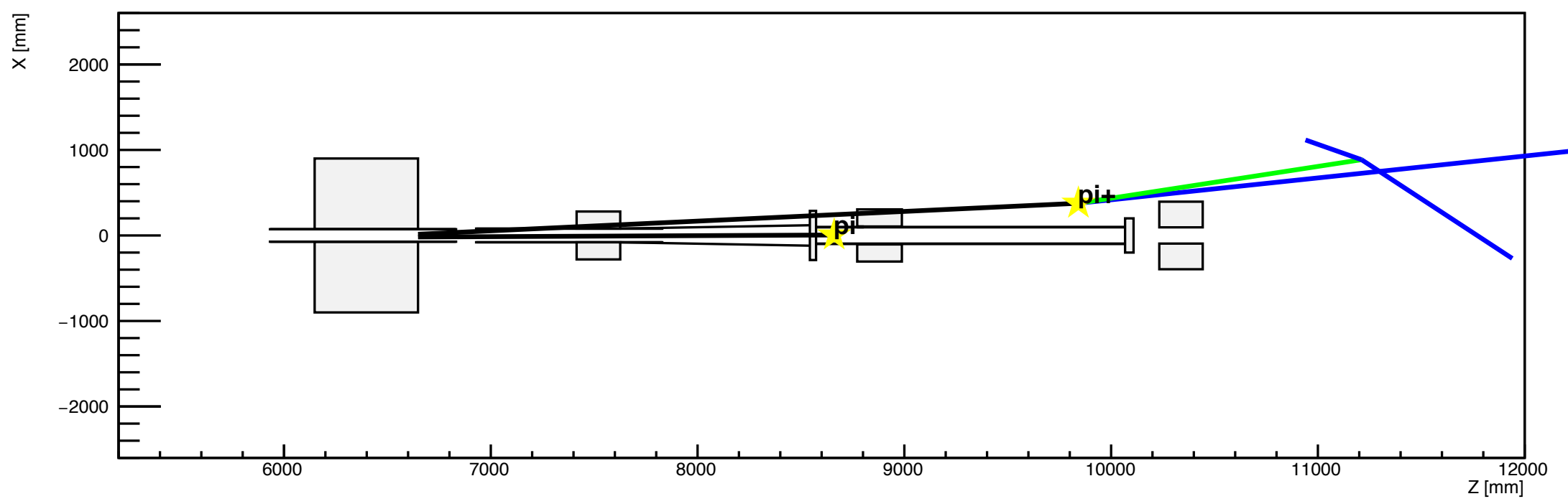

h1

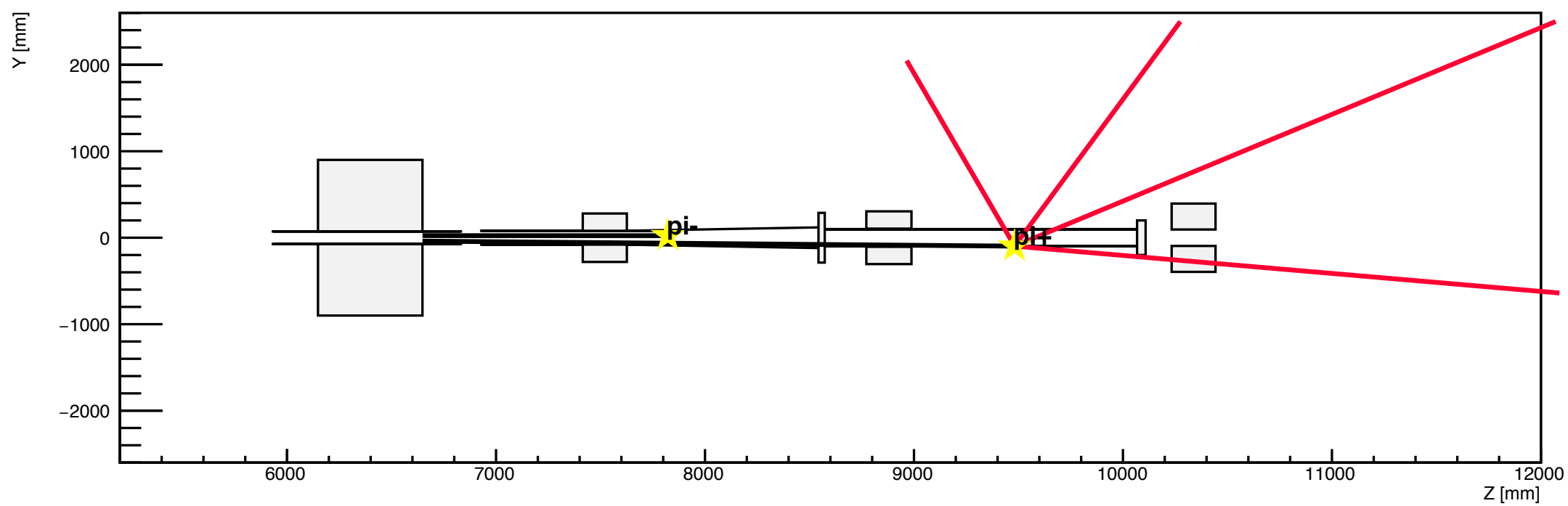

h2

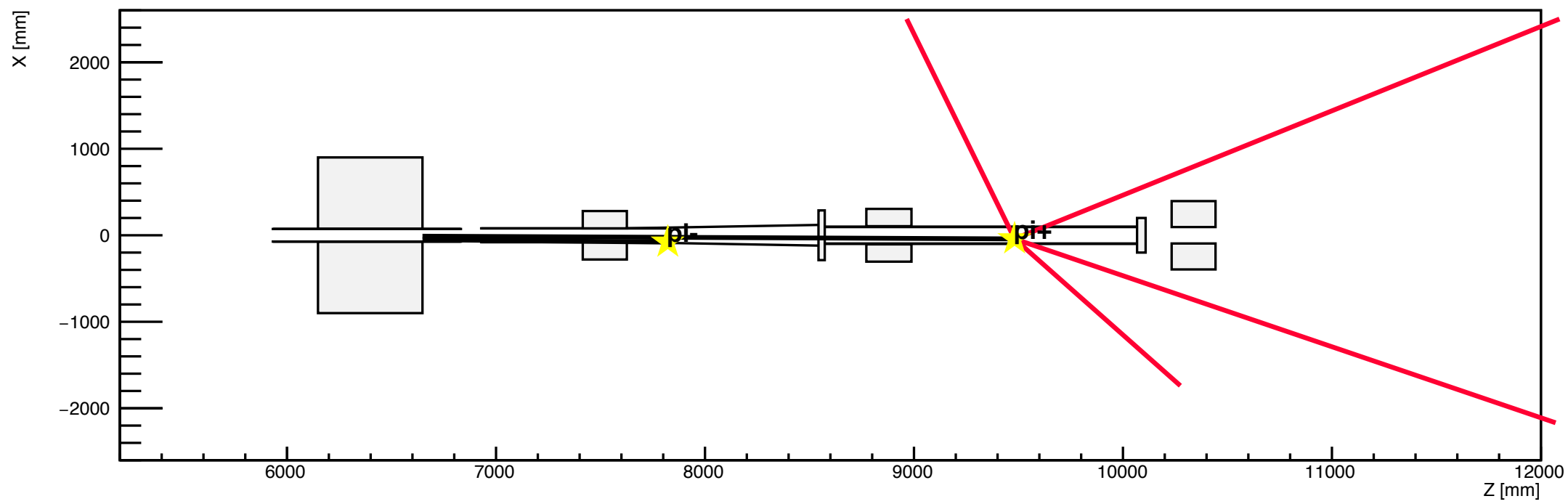

h1

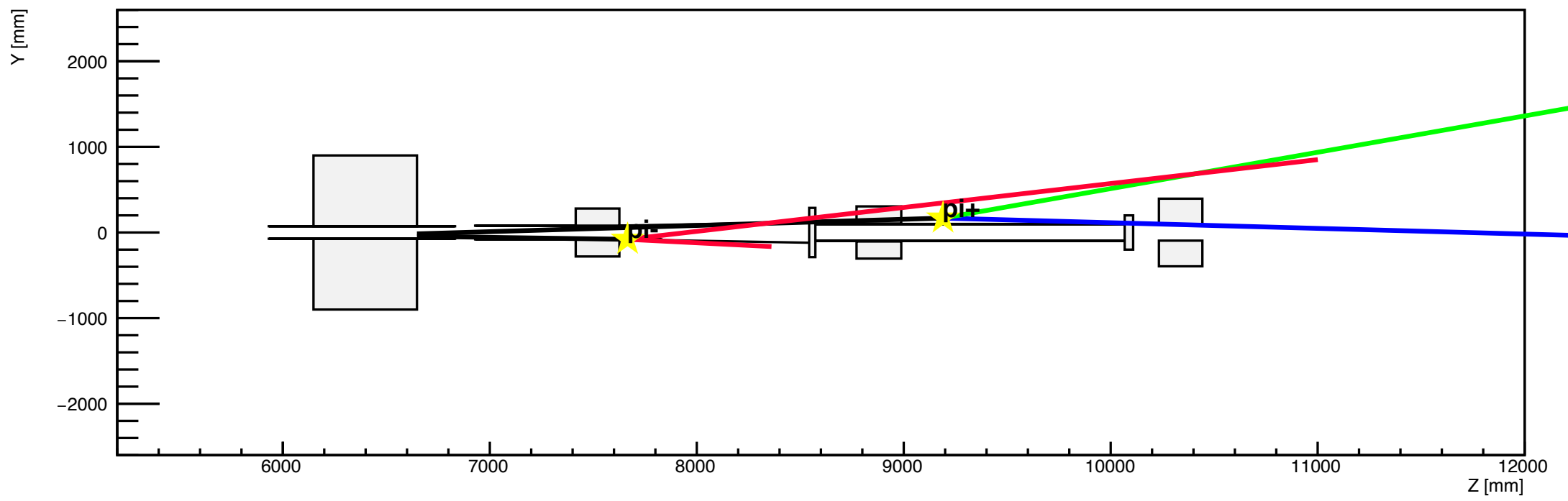

h2

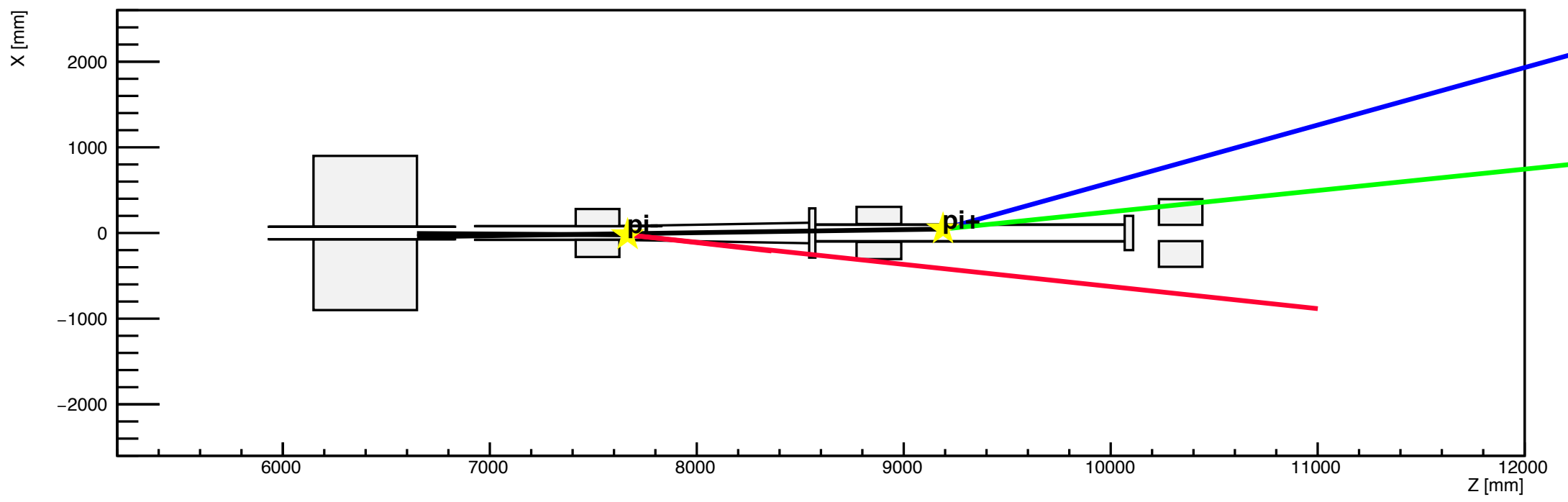

h1

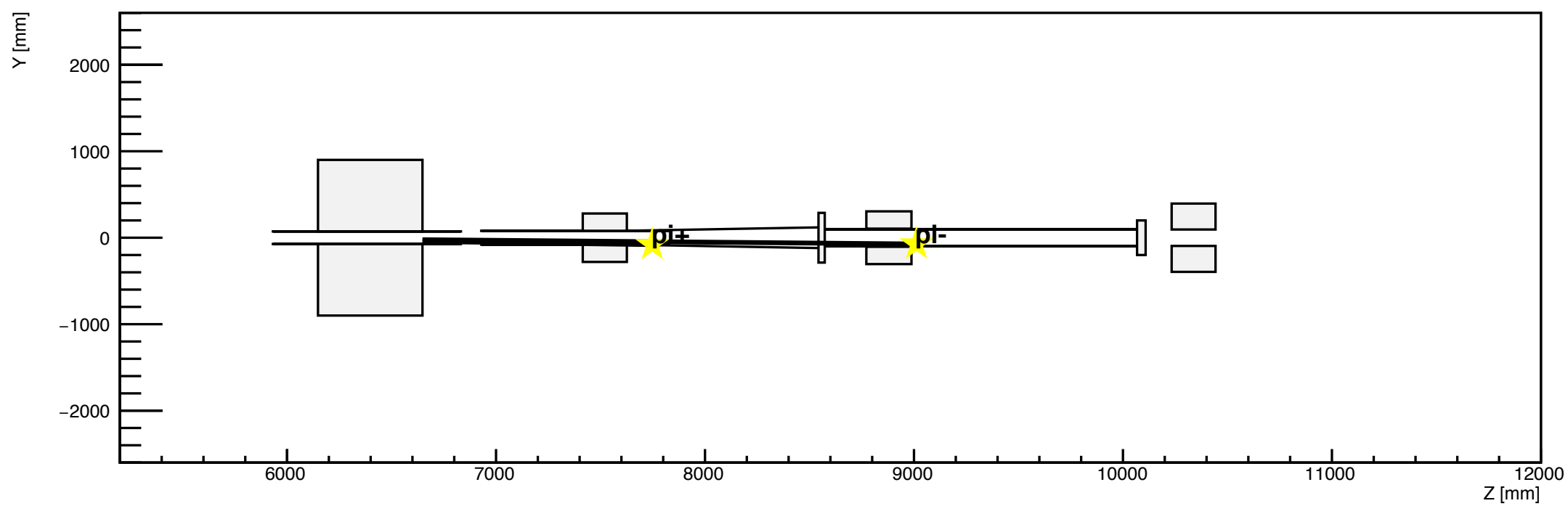

h2

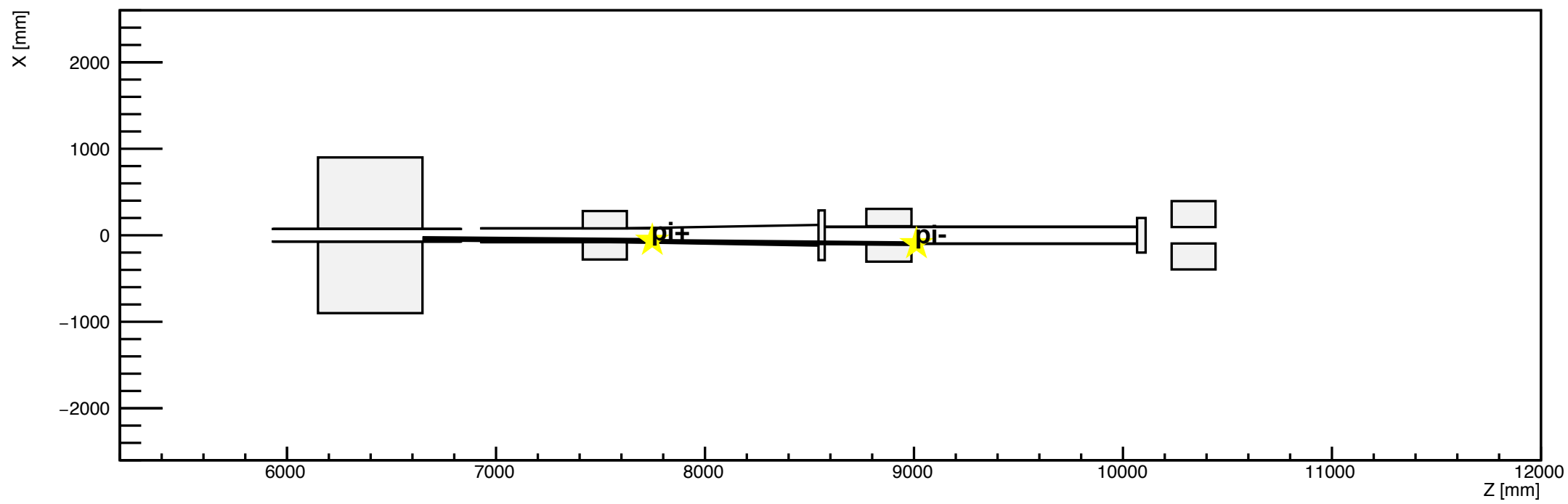

h1

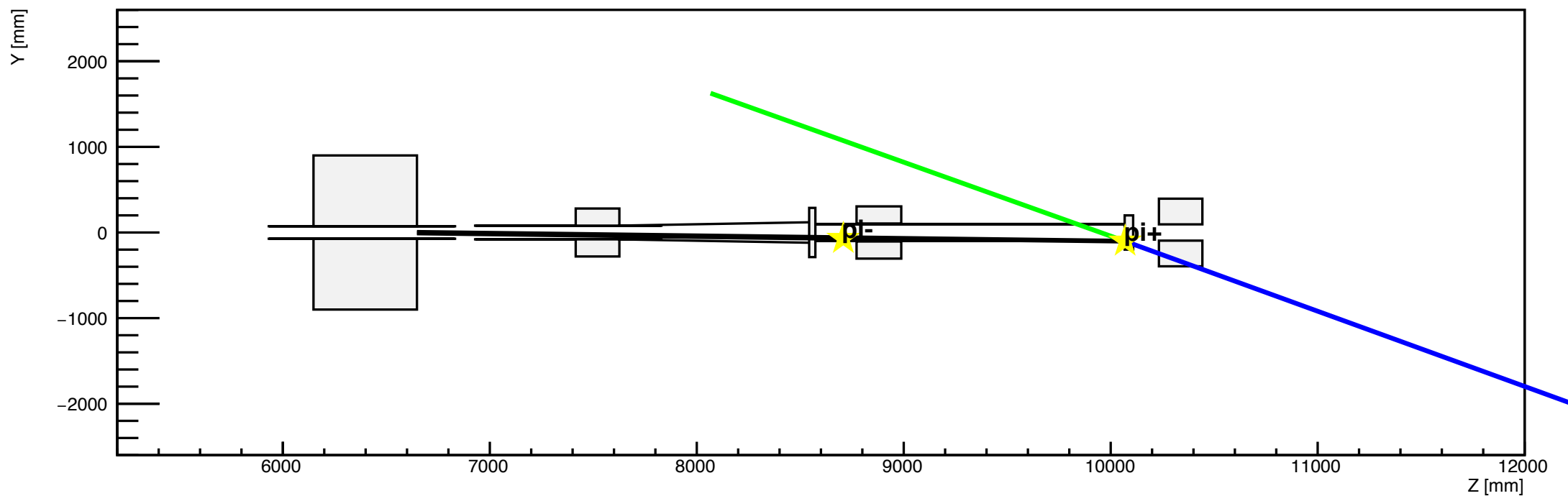

h2

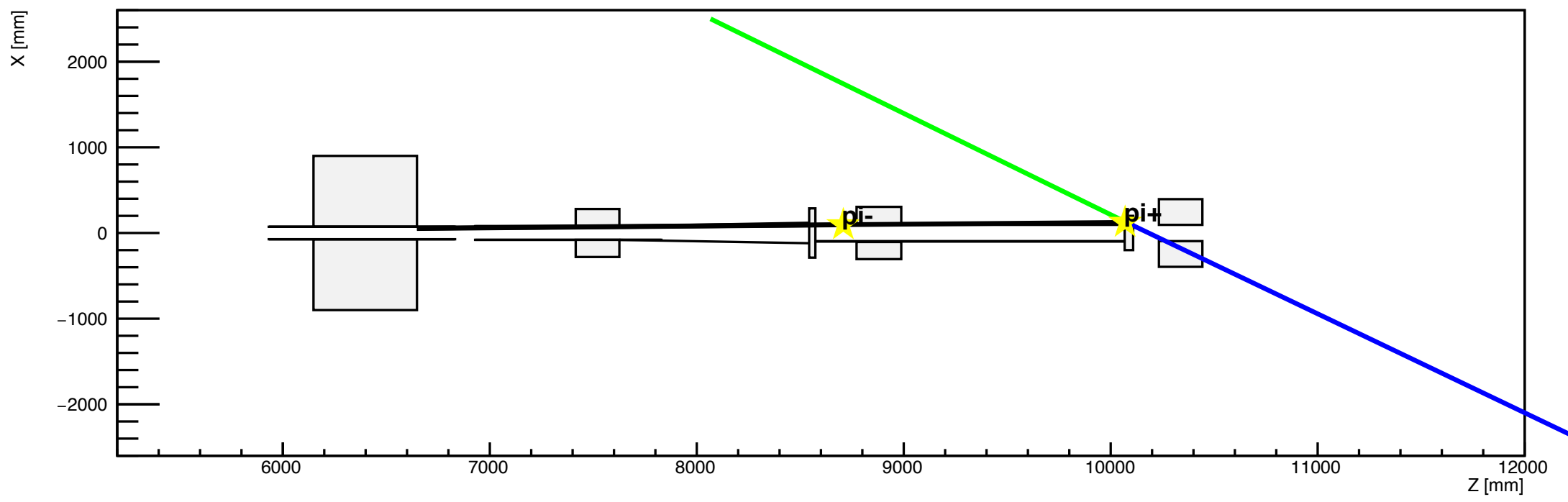

h1

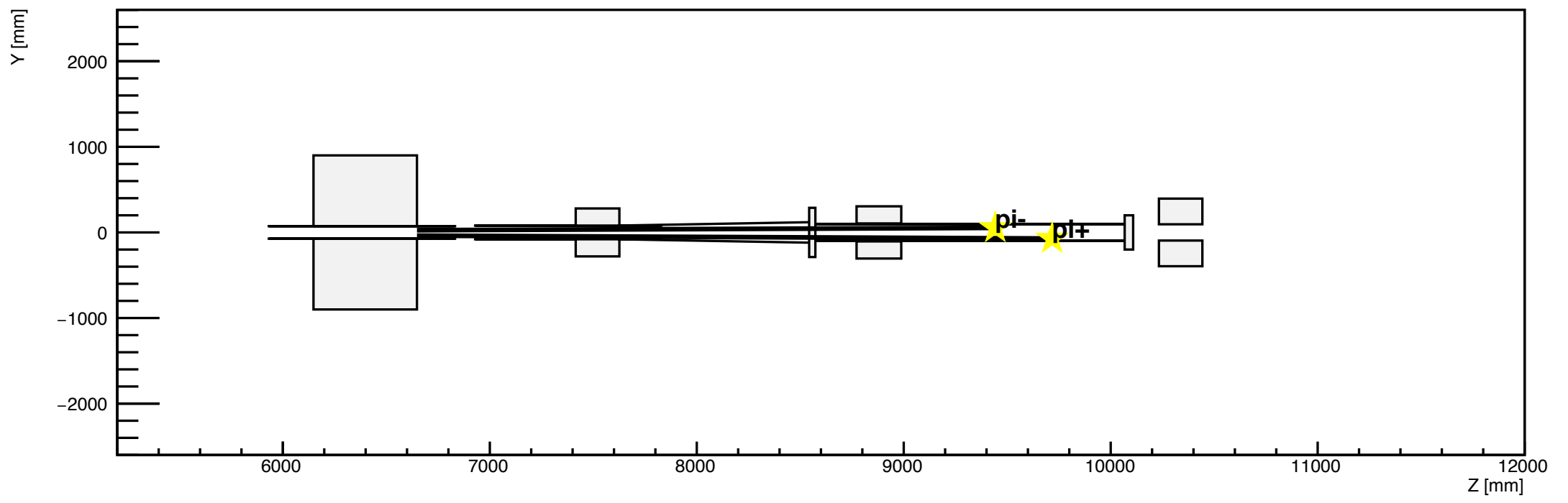

h2

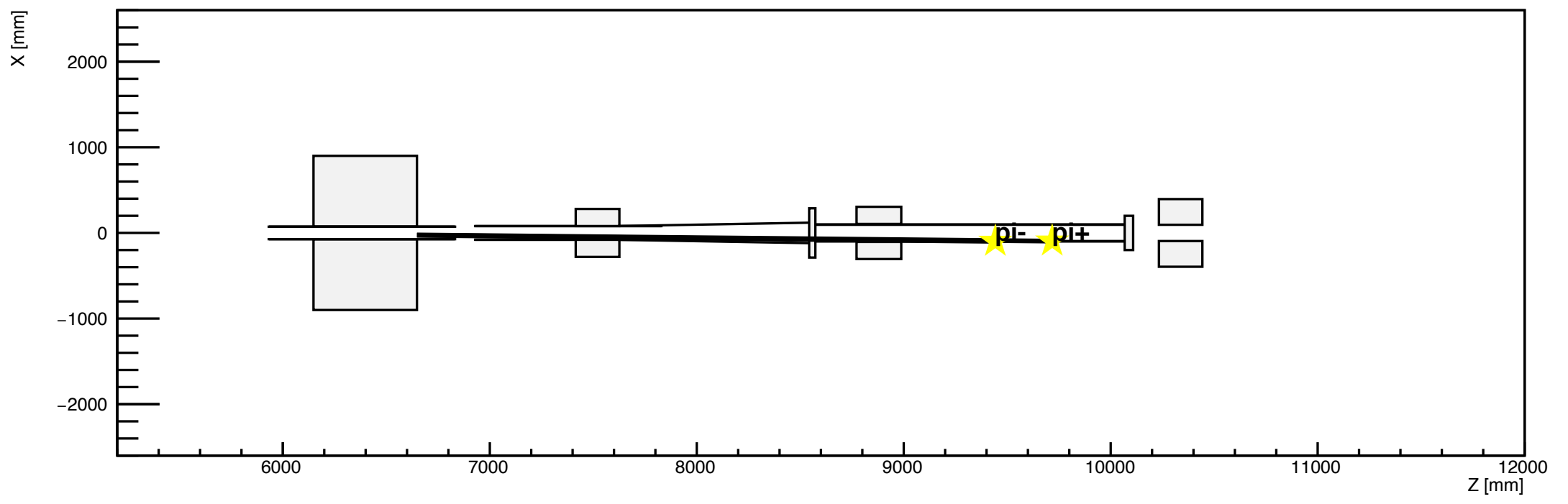

h1

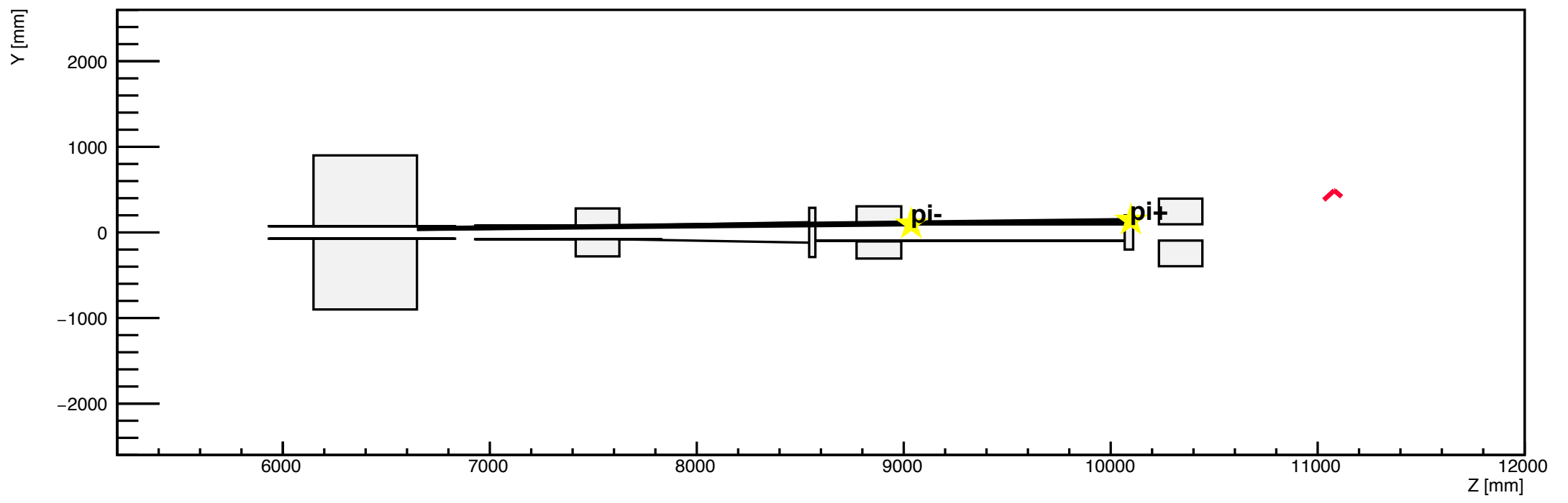

h2

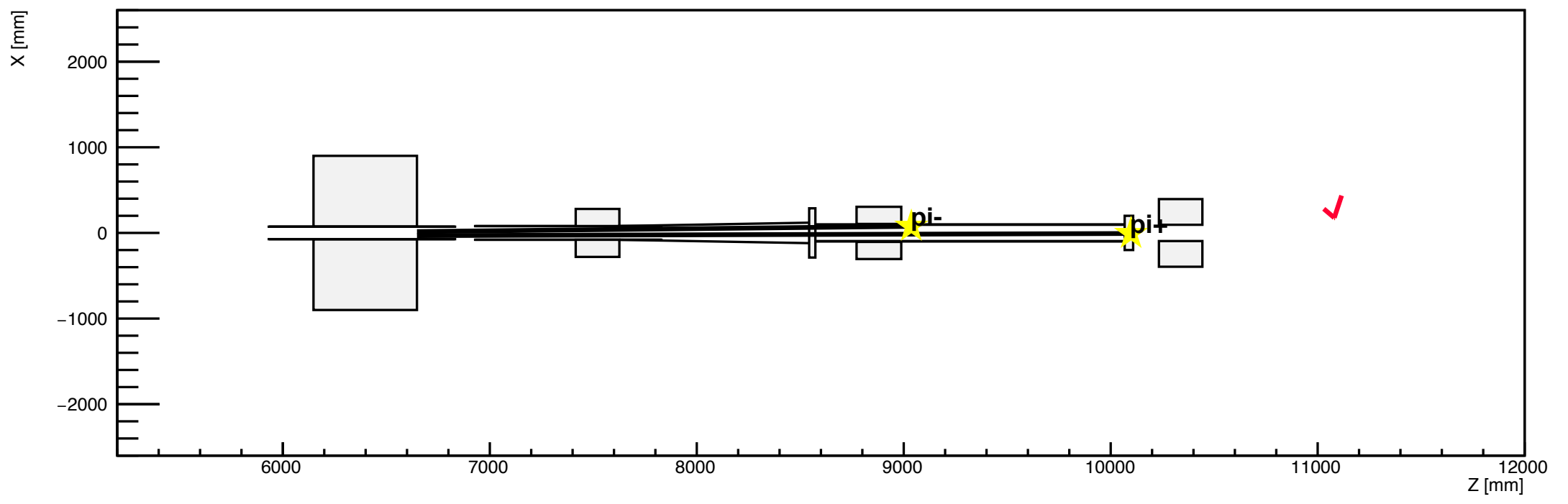

h1

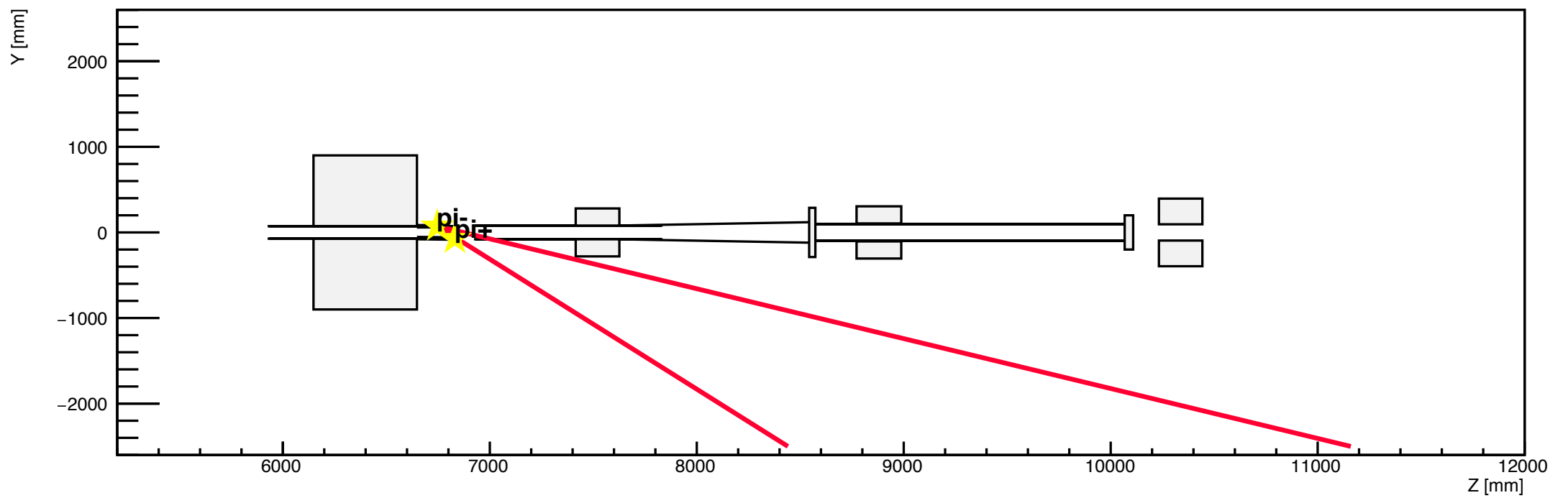

h2

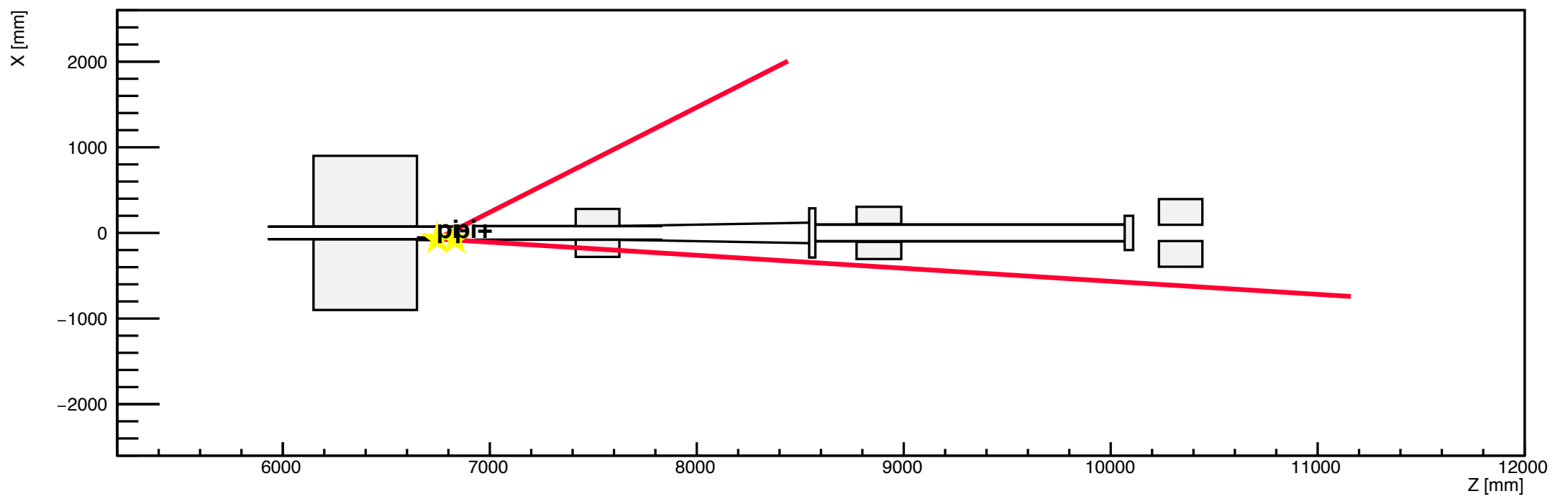

h1

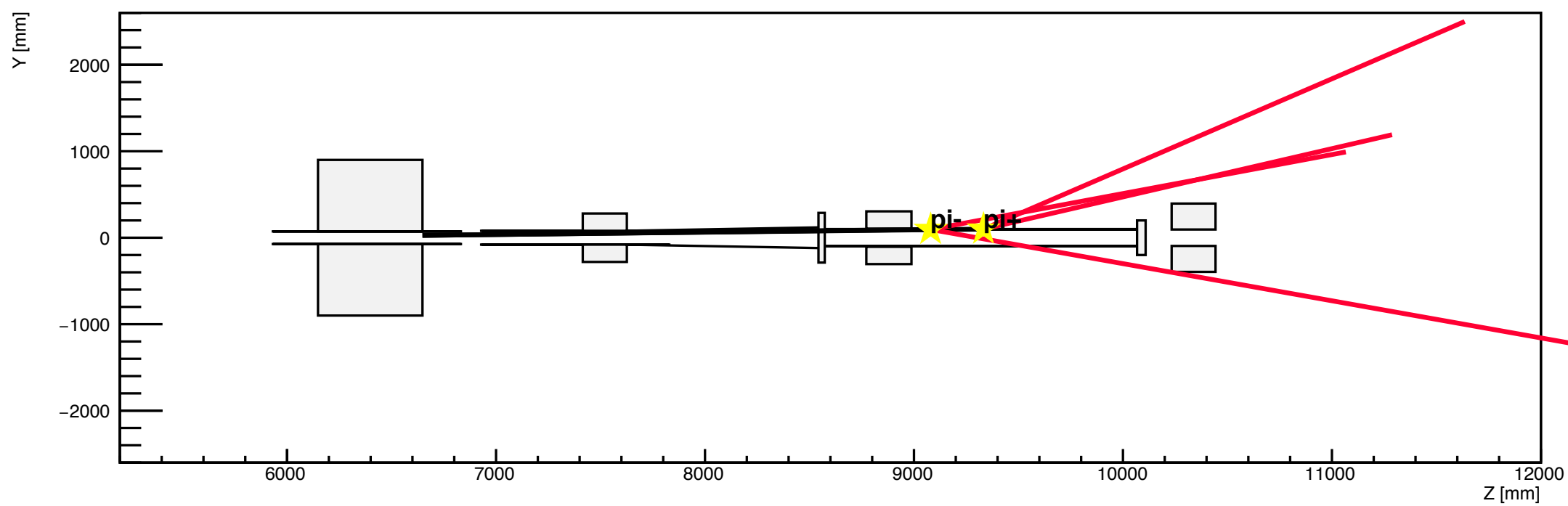

h2

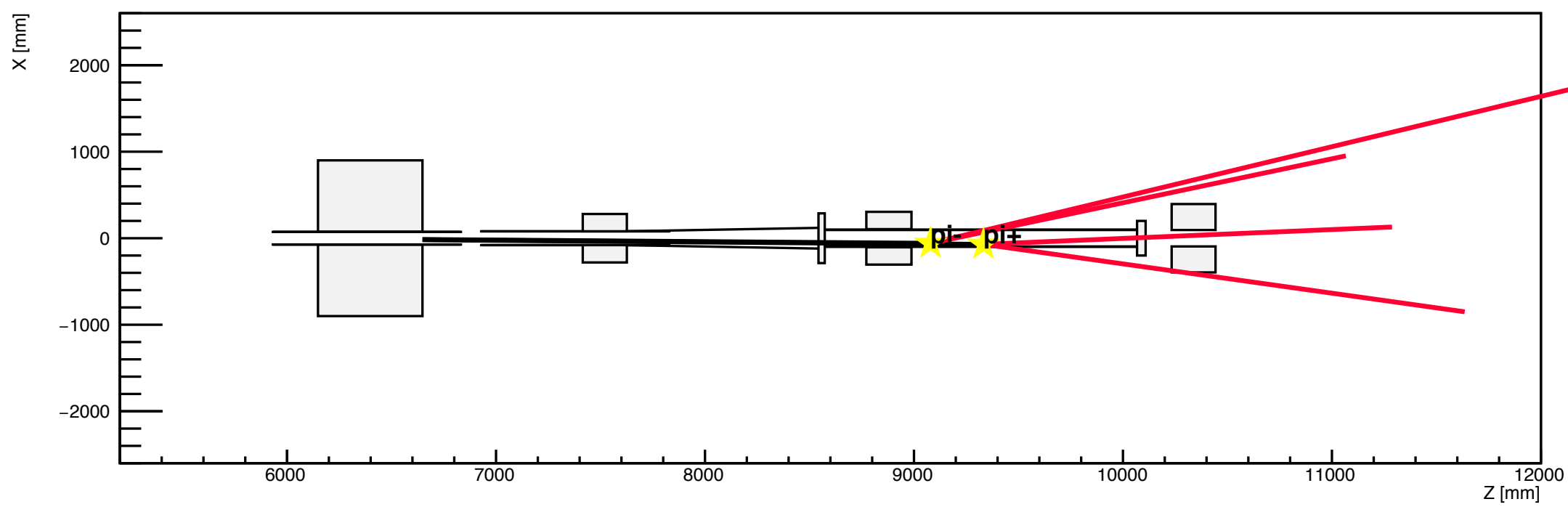

h1

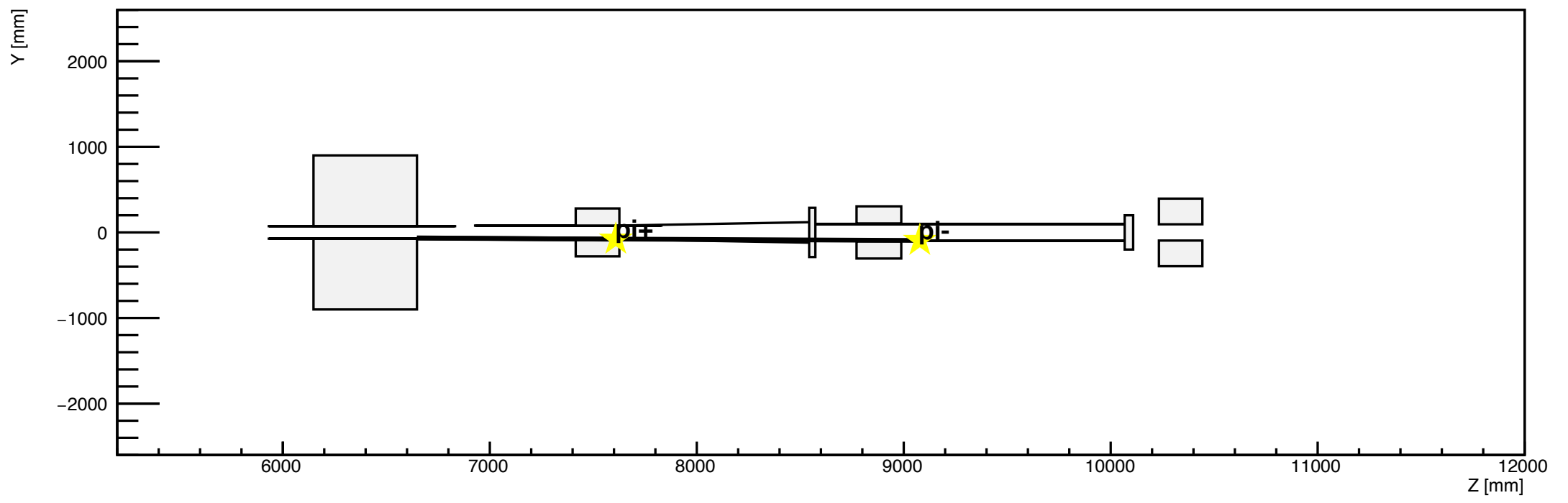

h2

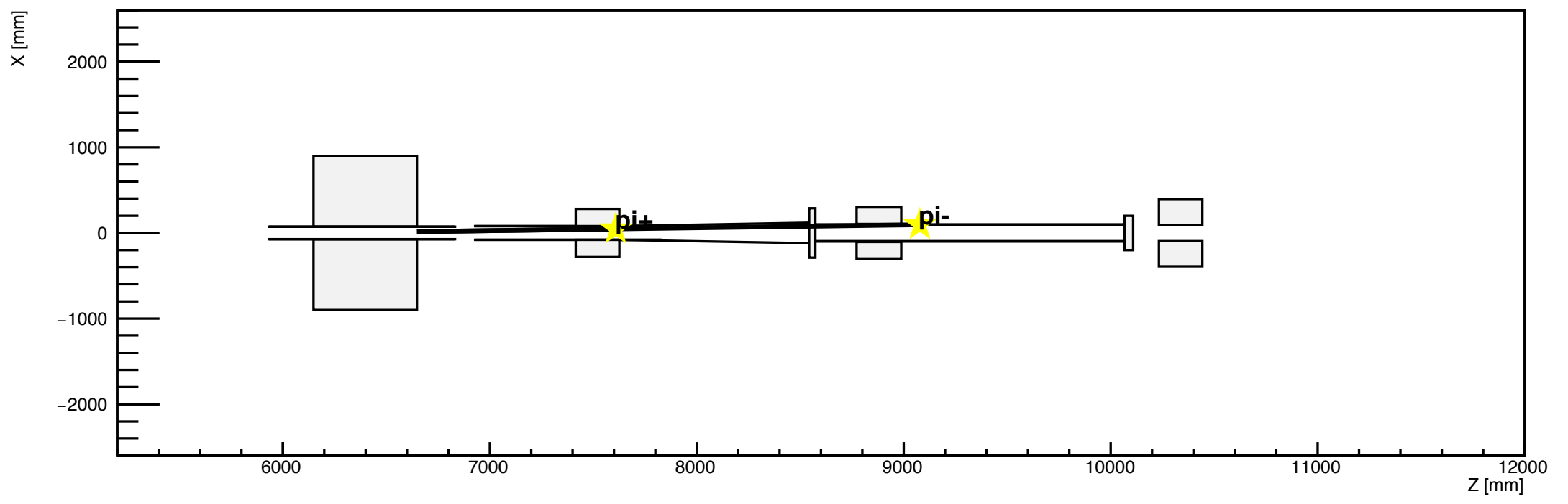

h1

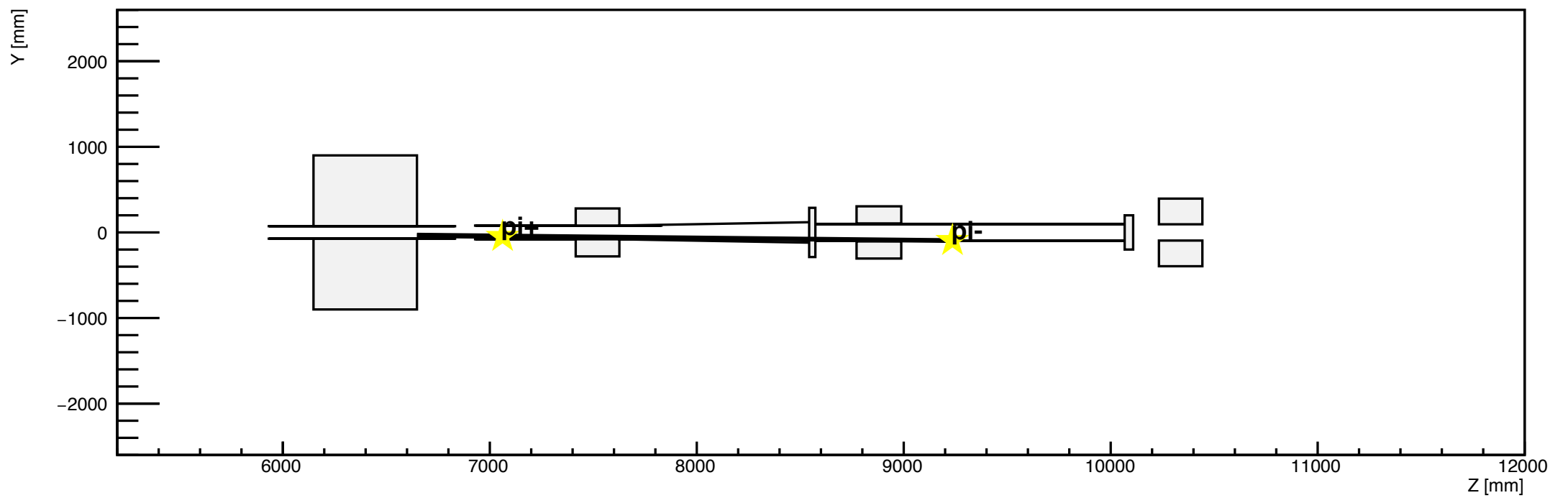

h2

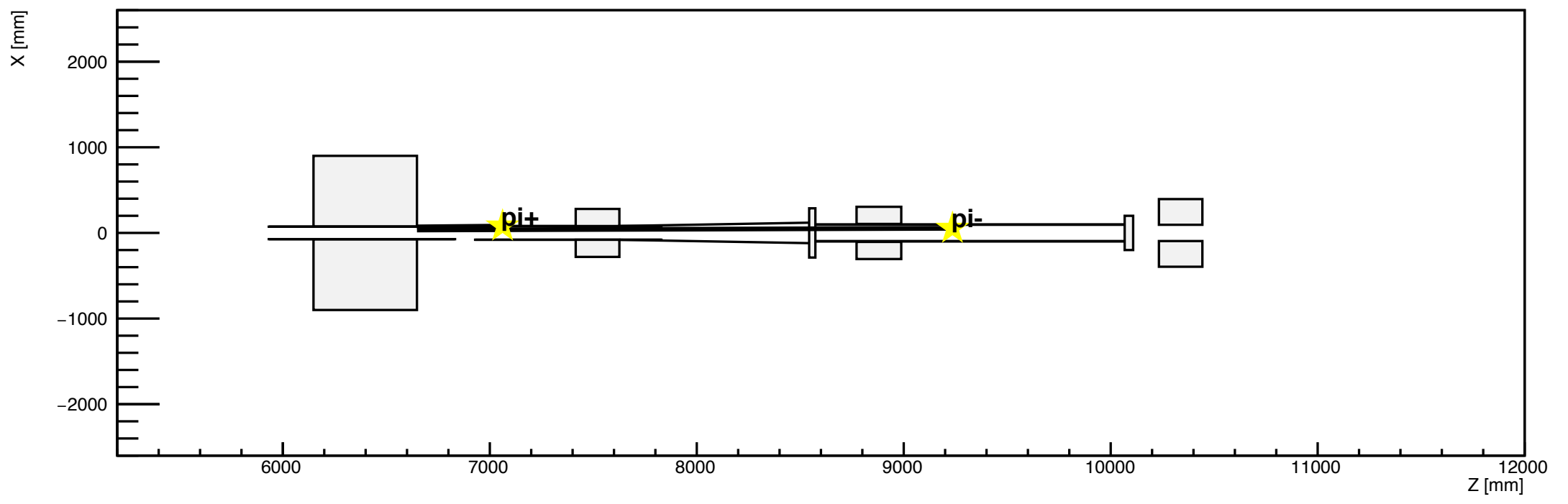

h1

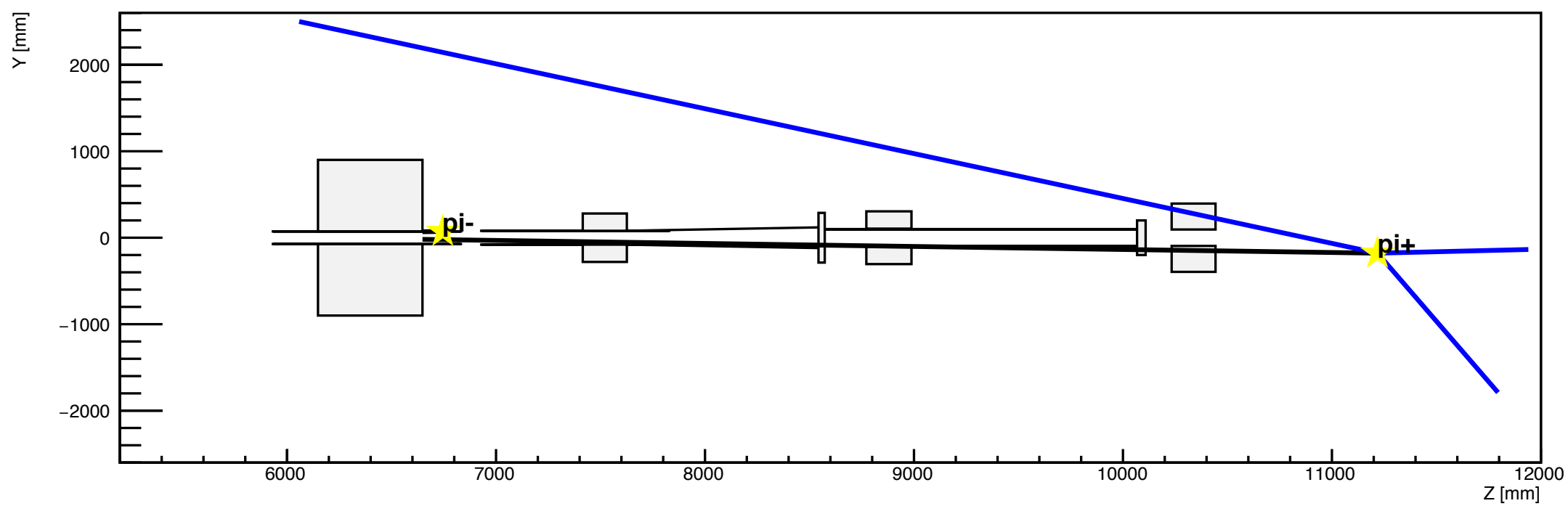

h2

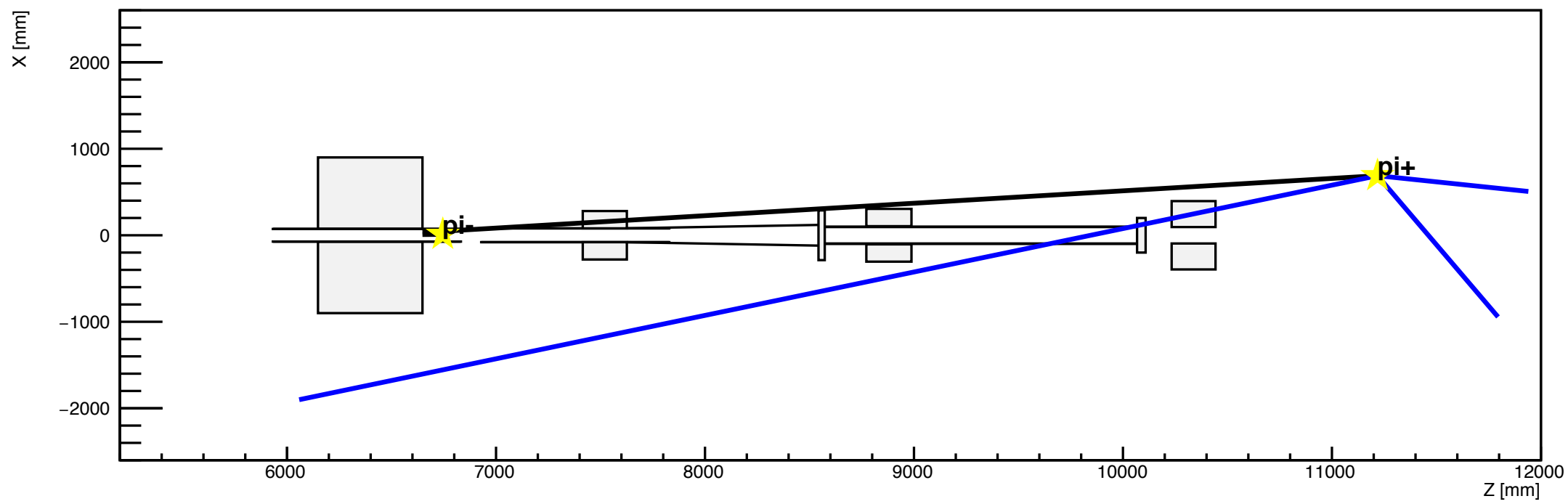

h1

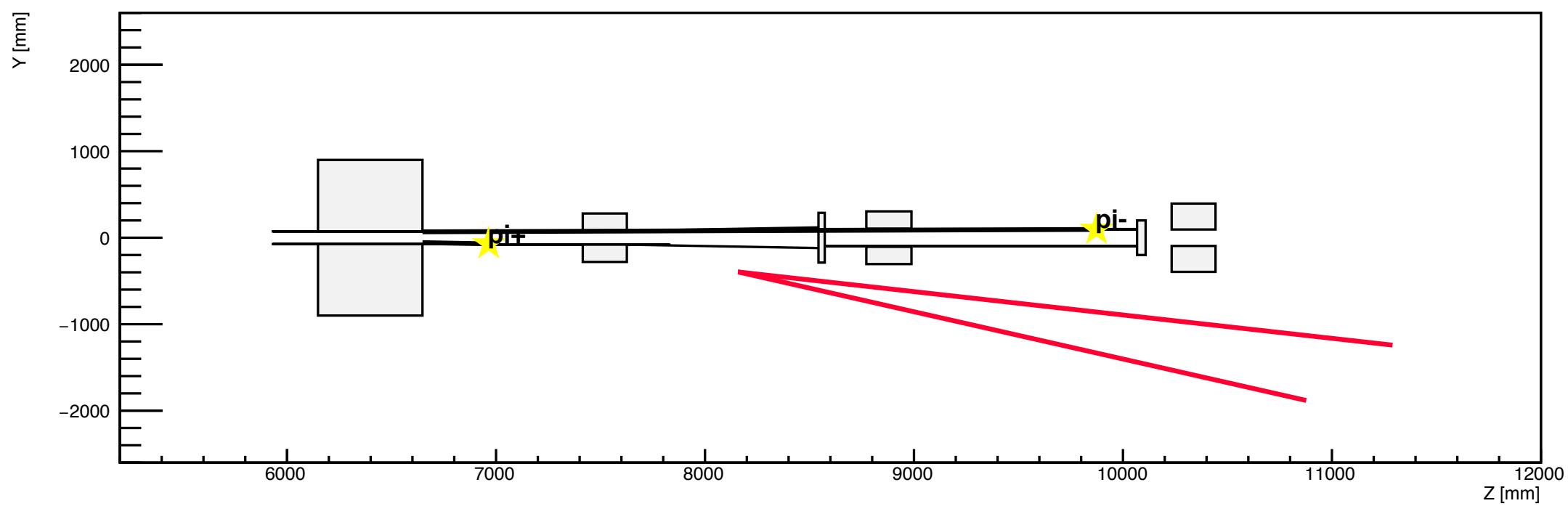

h2

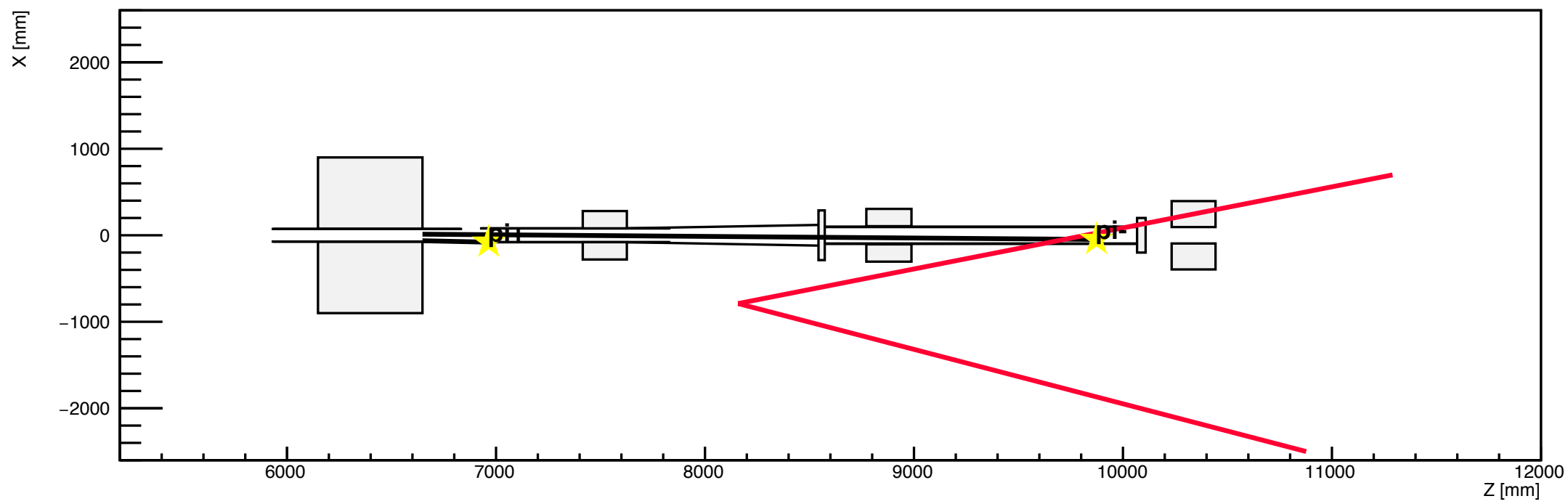

h1

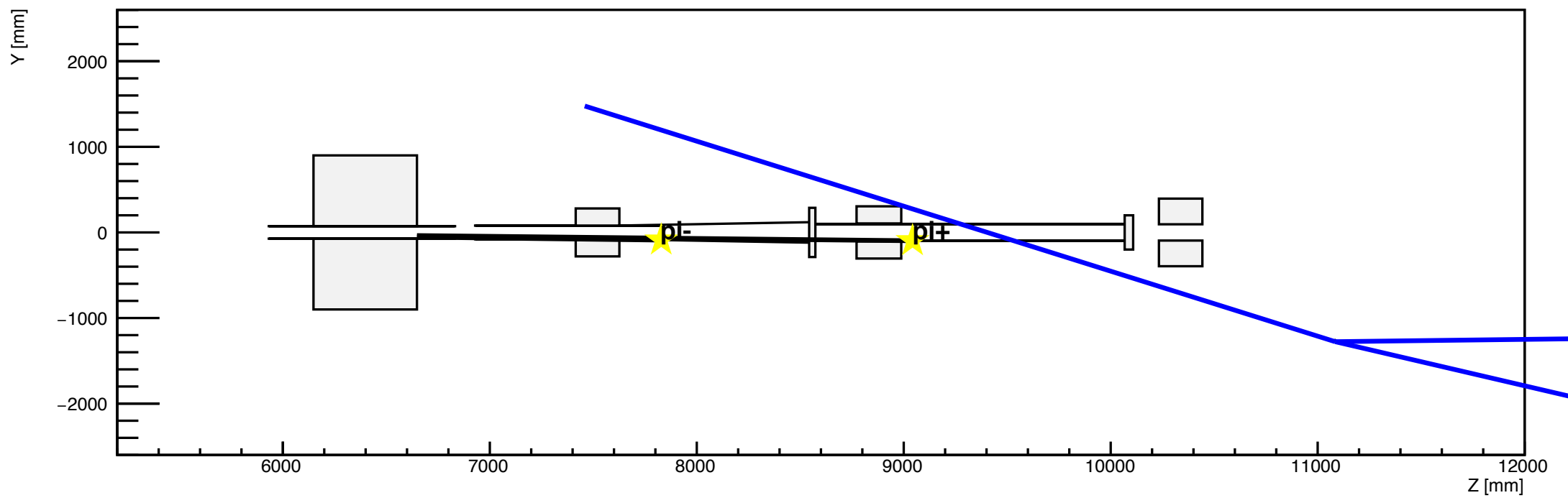

h2

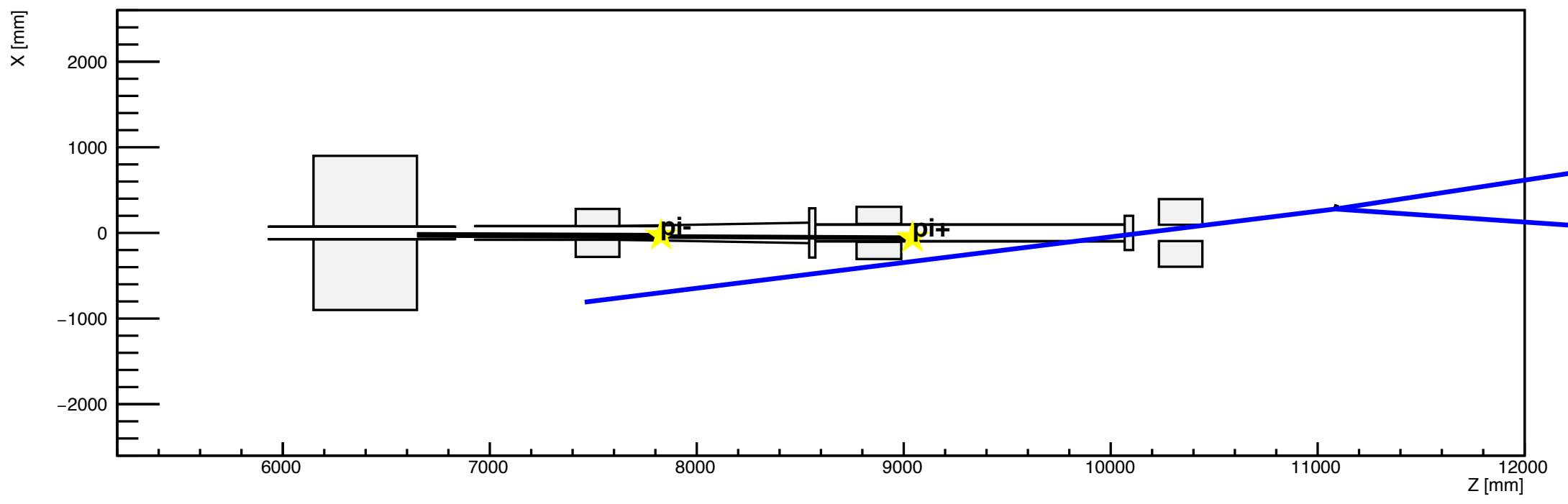

h1

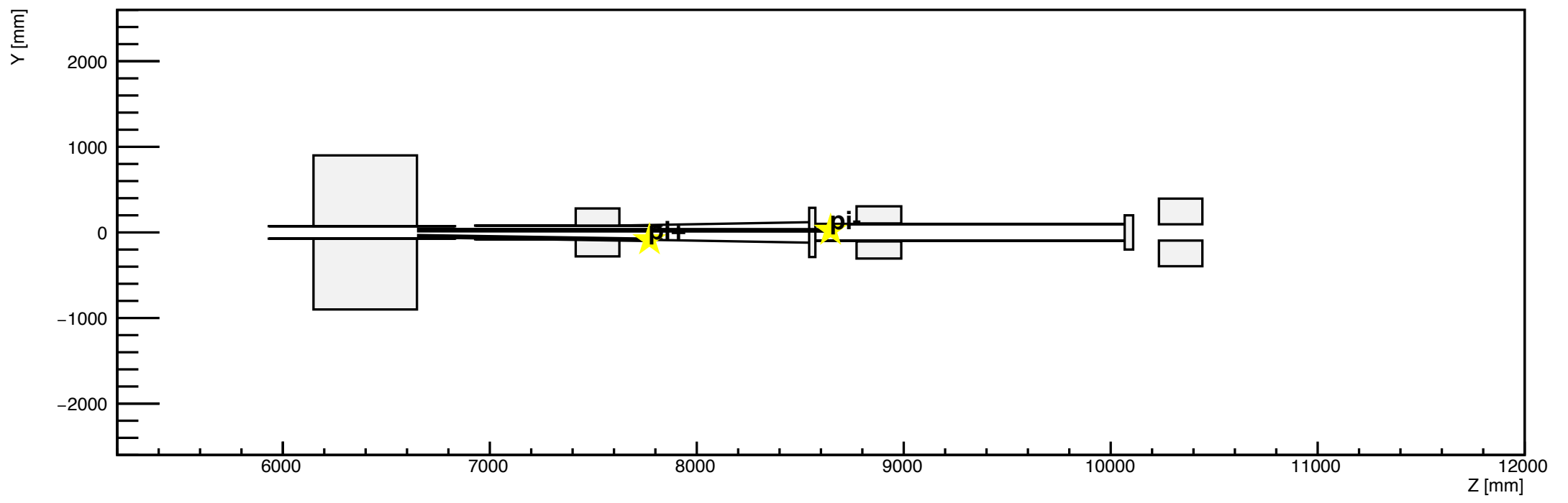

h2

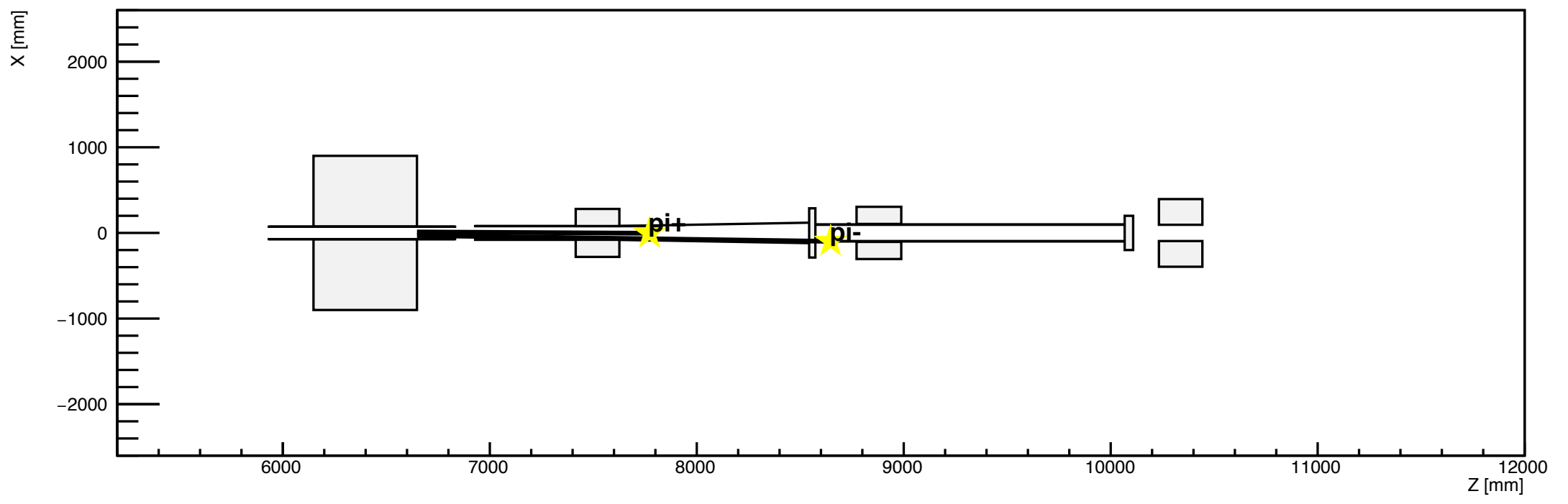

h1

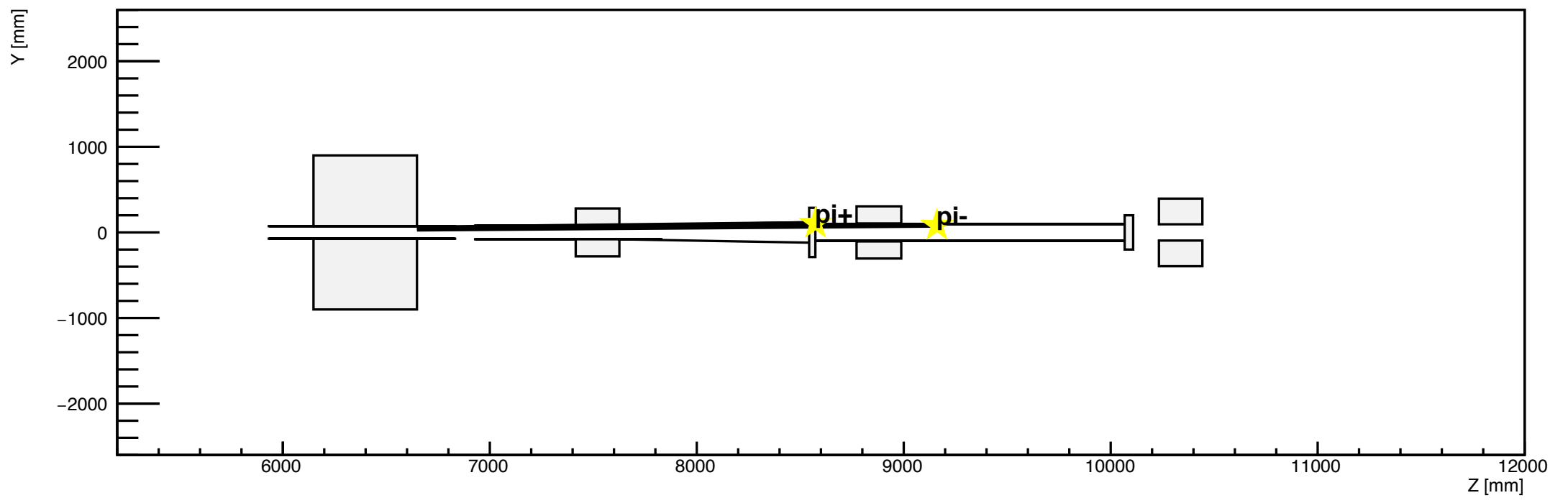

h2

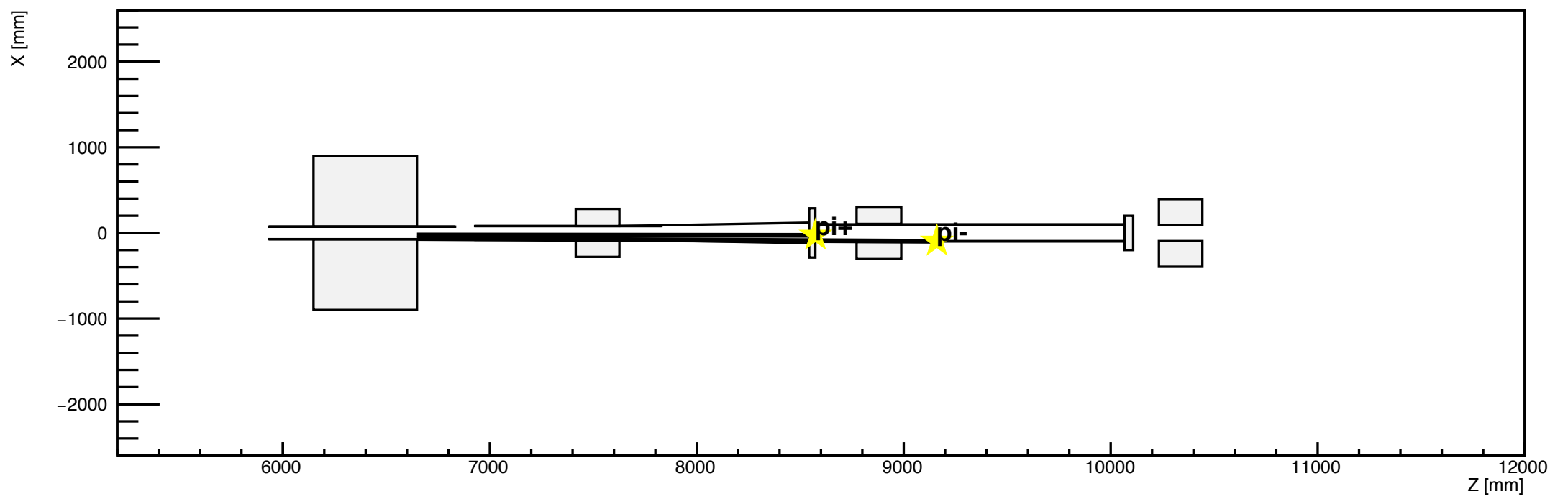

h1

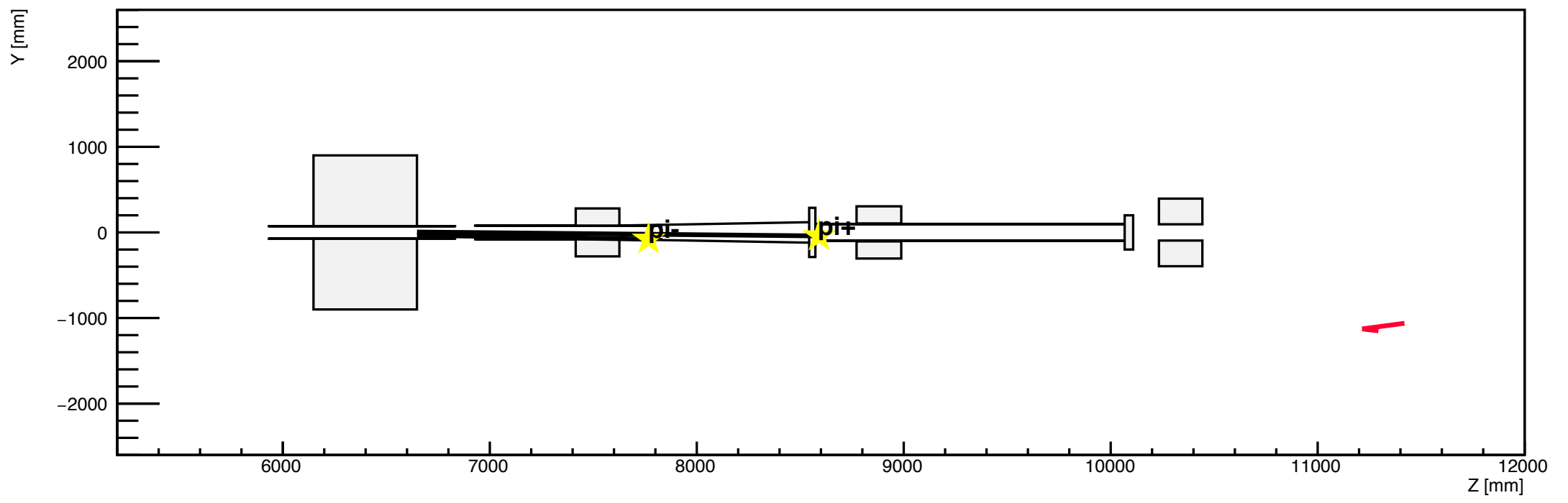

h2

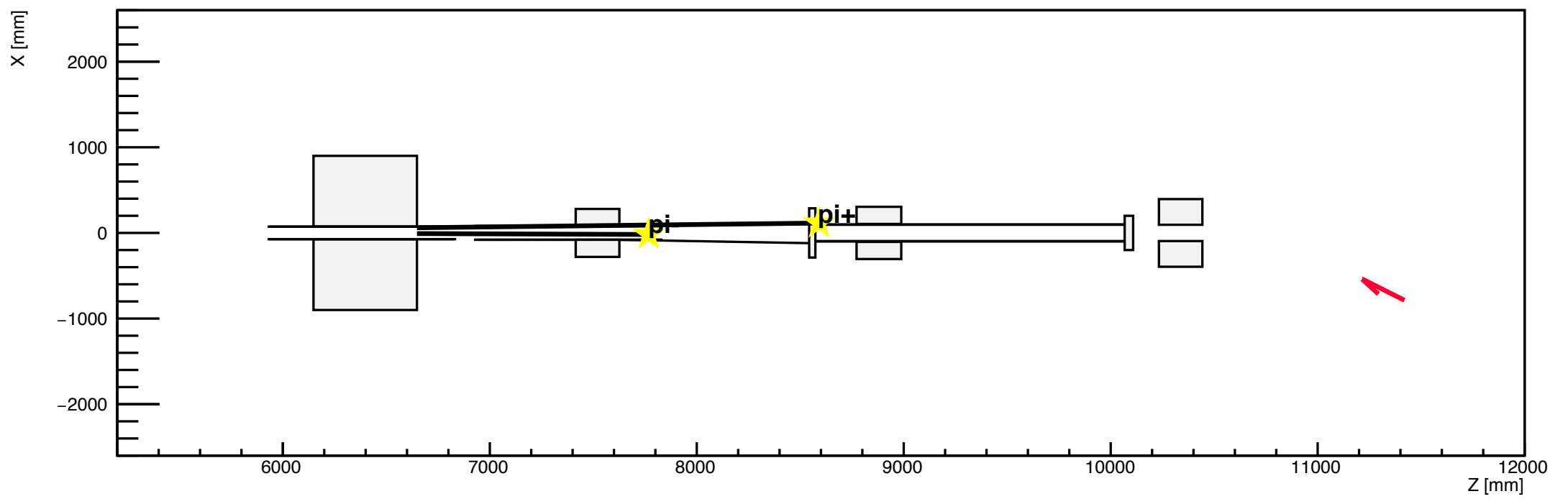

h1

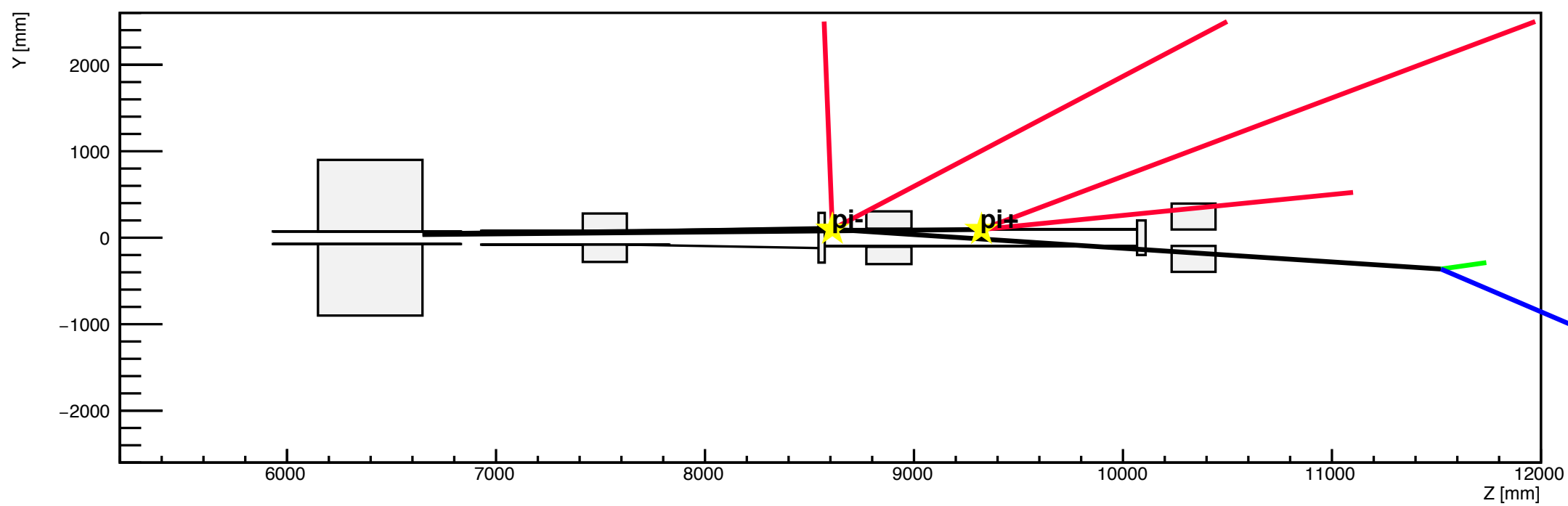

h2

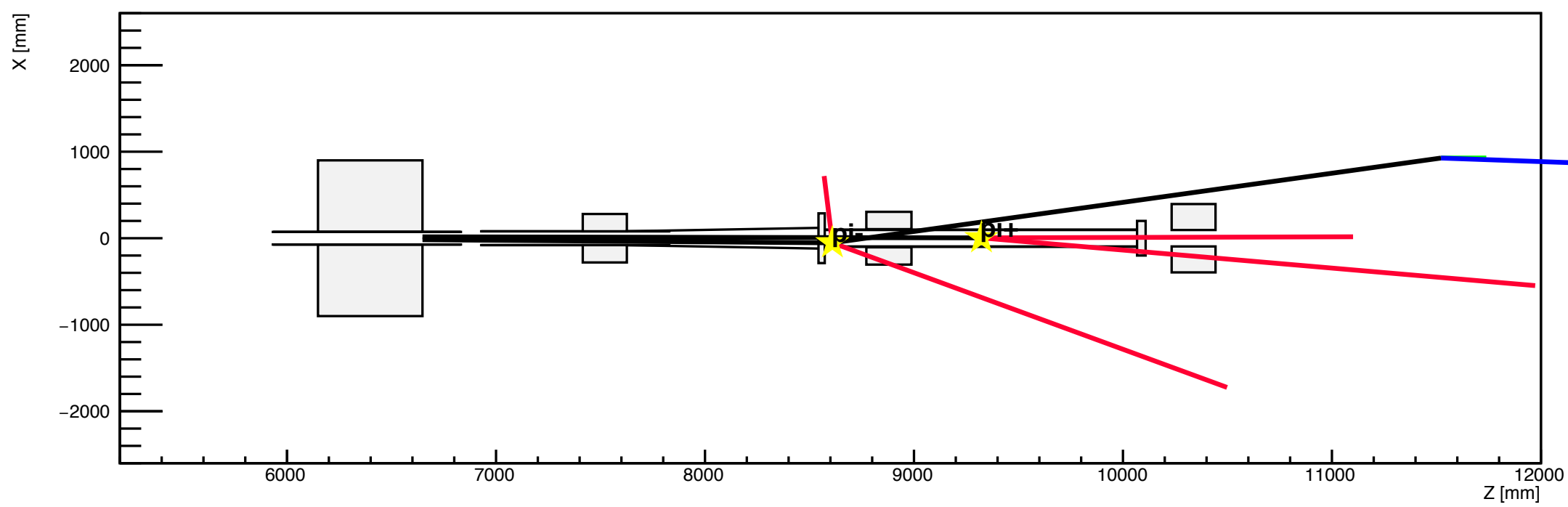

h1

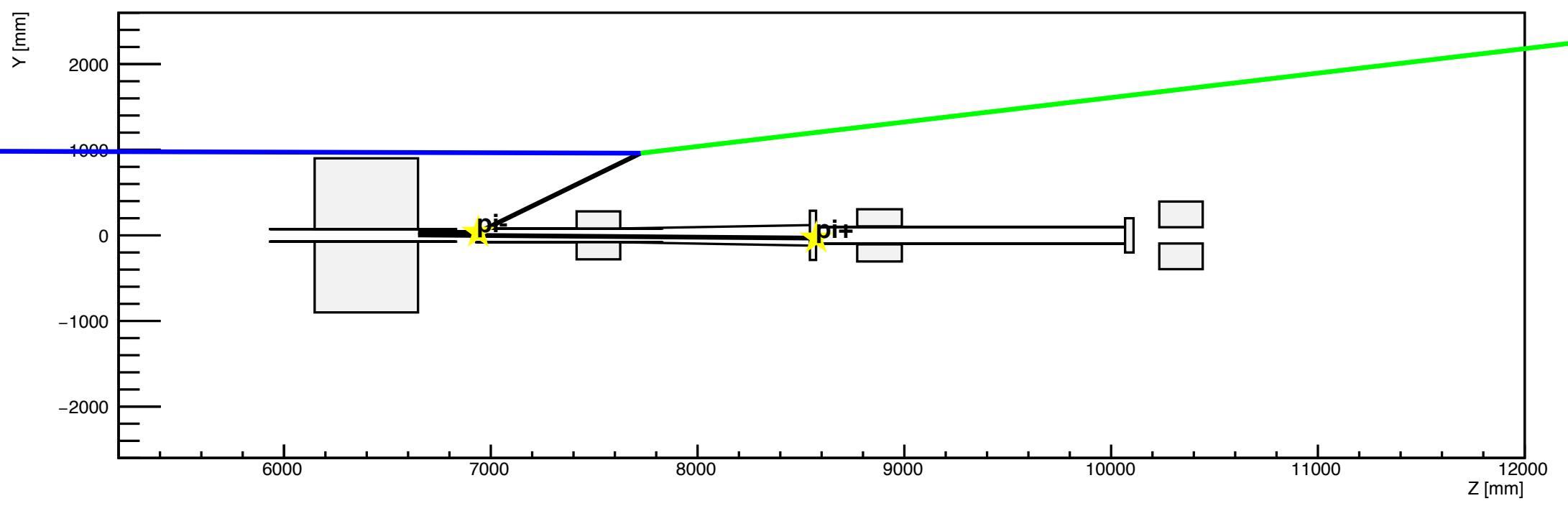

h2

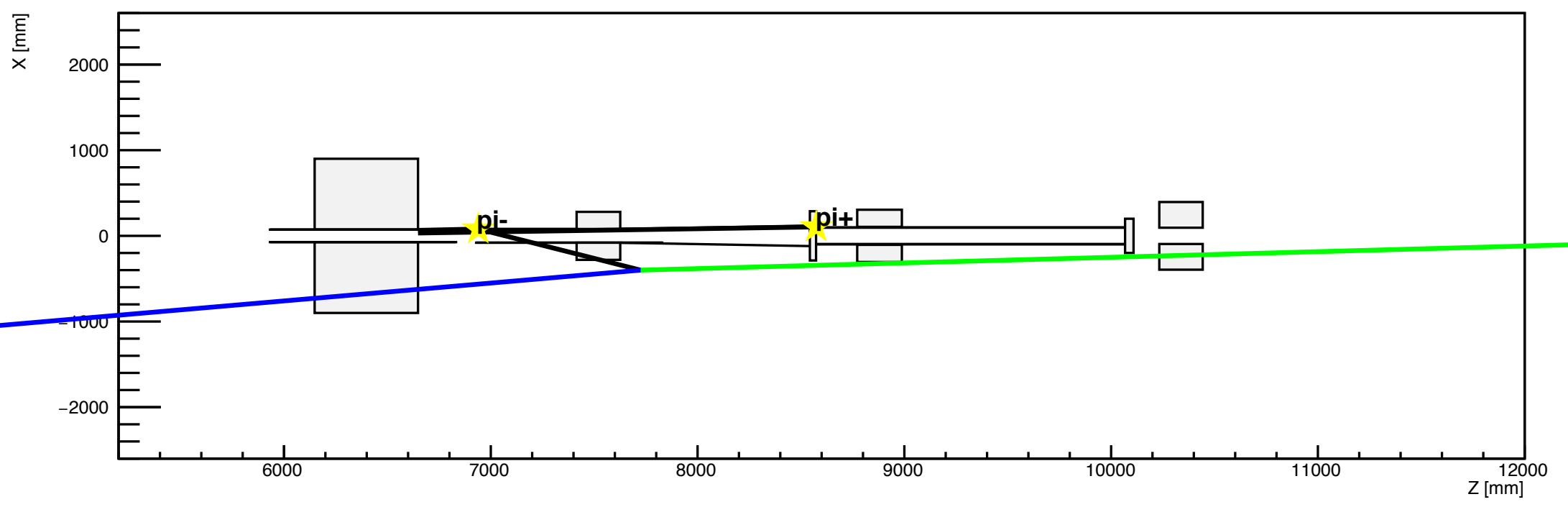

h1

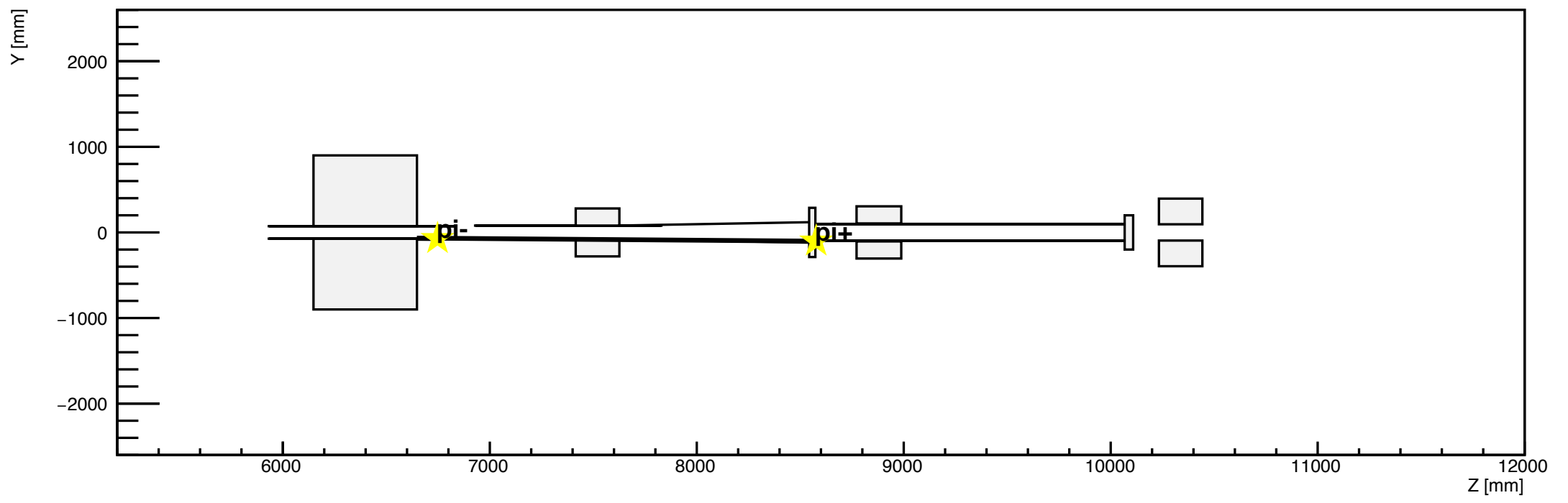

h2

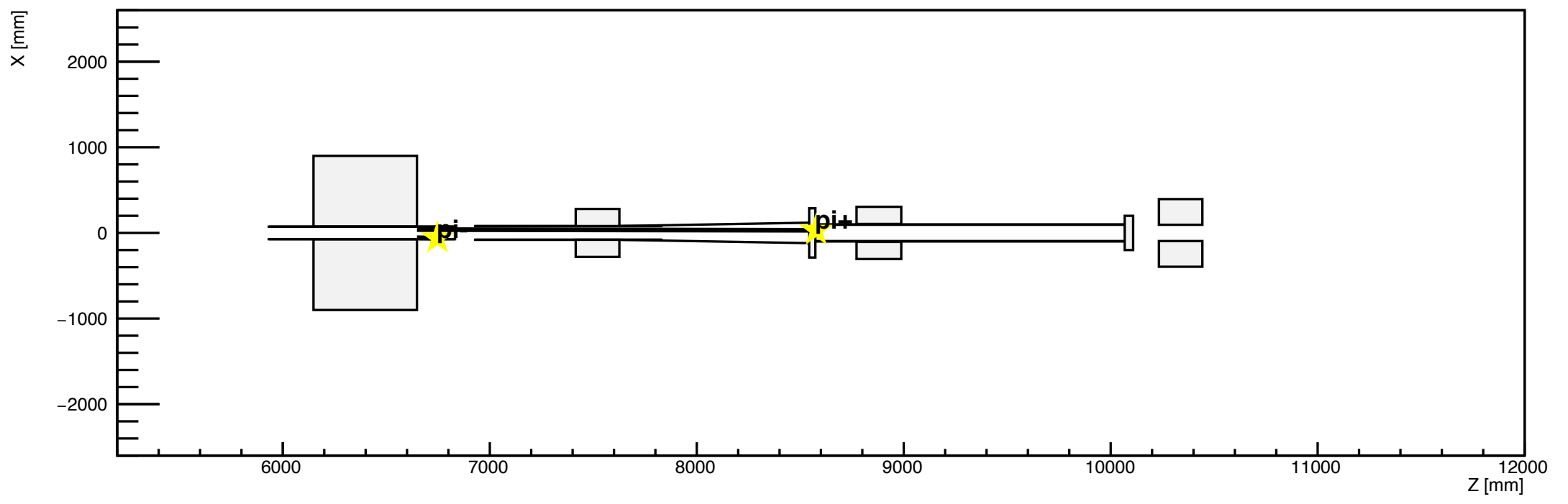

h1

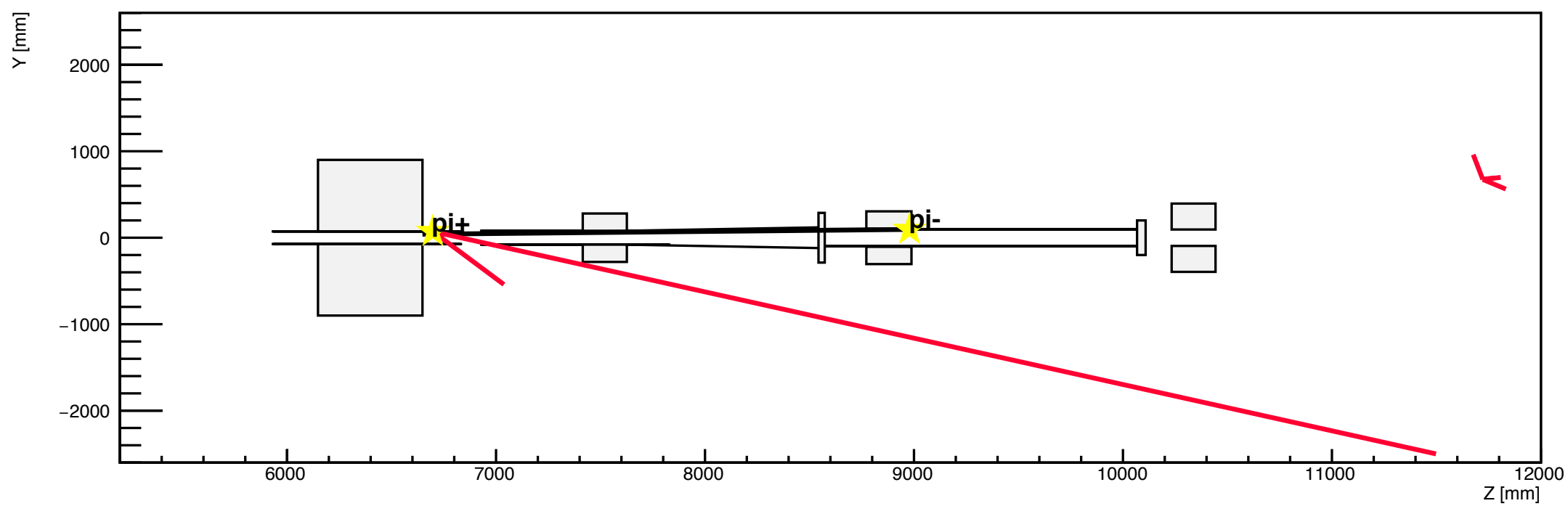

h2

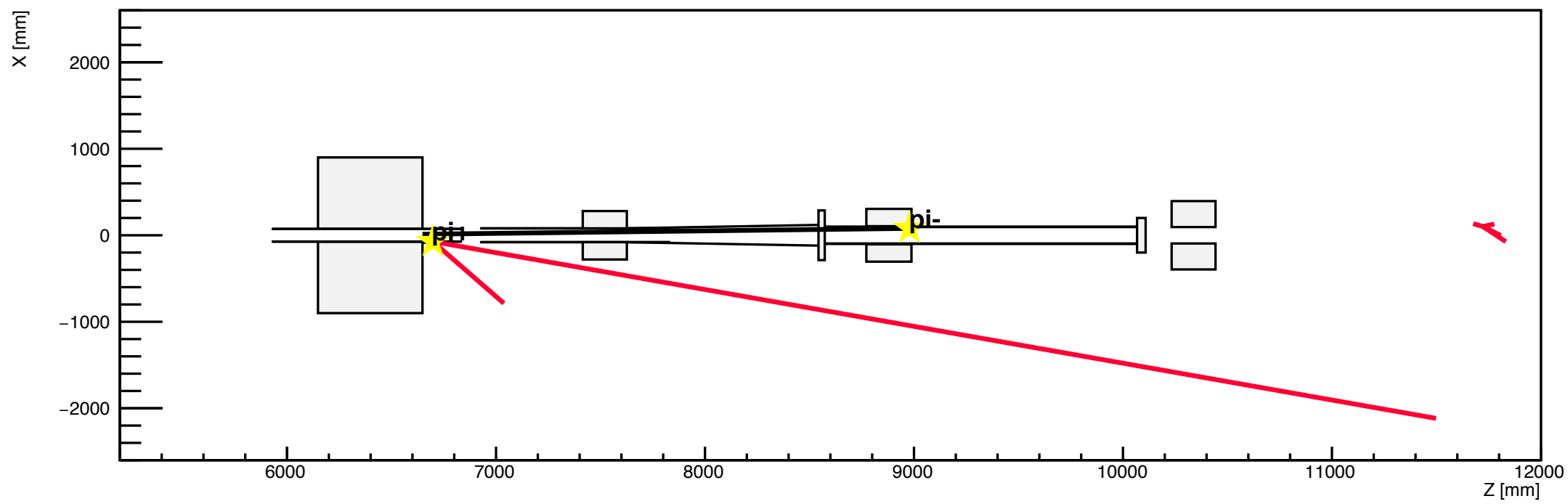

h1

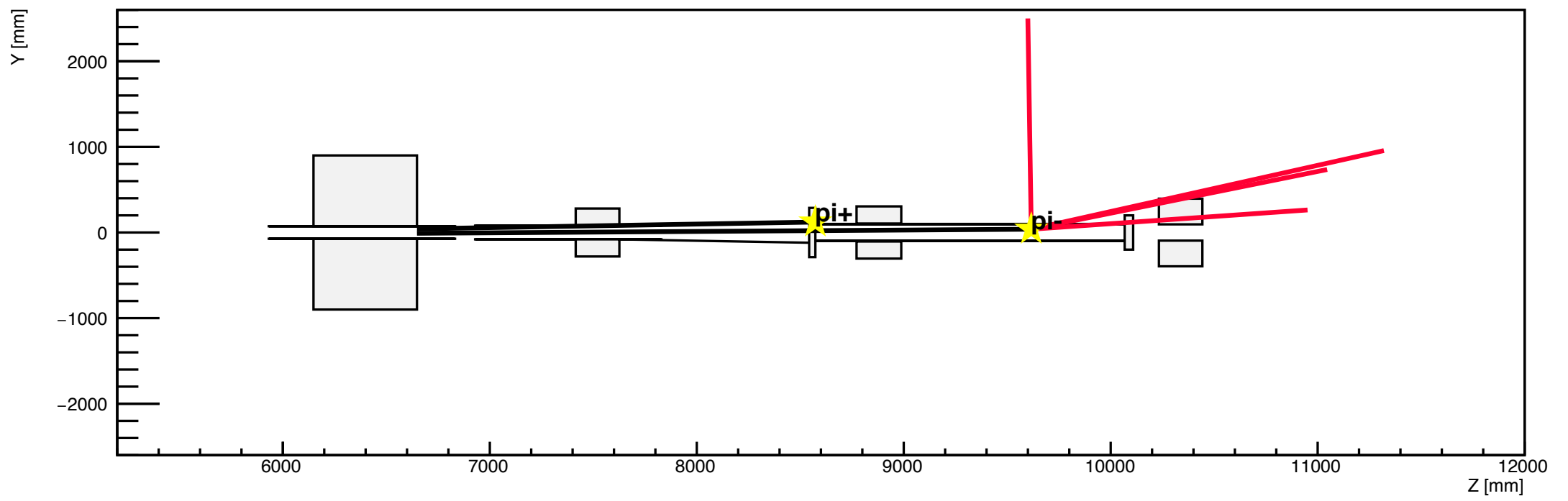

h2

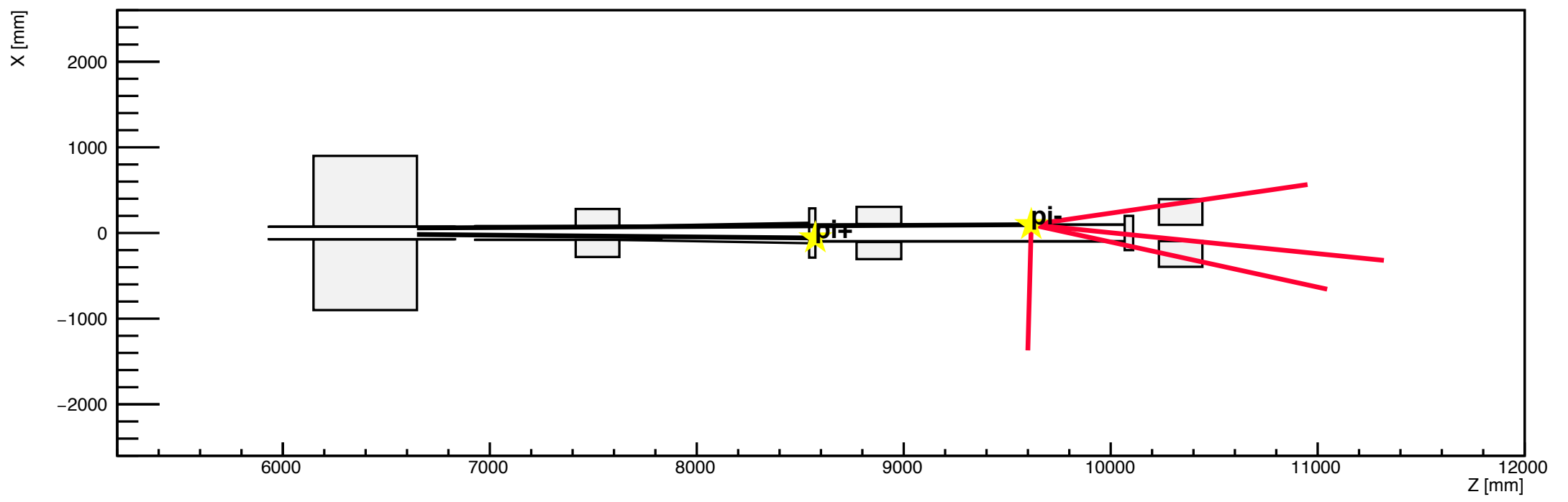

h1

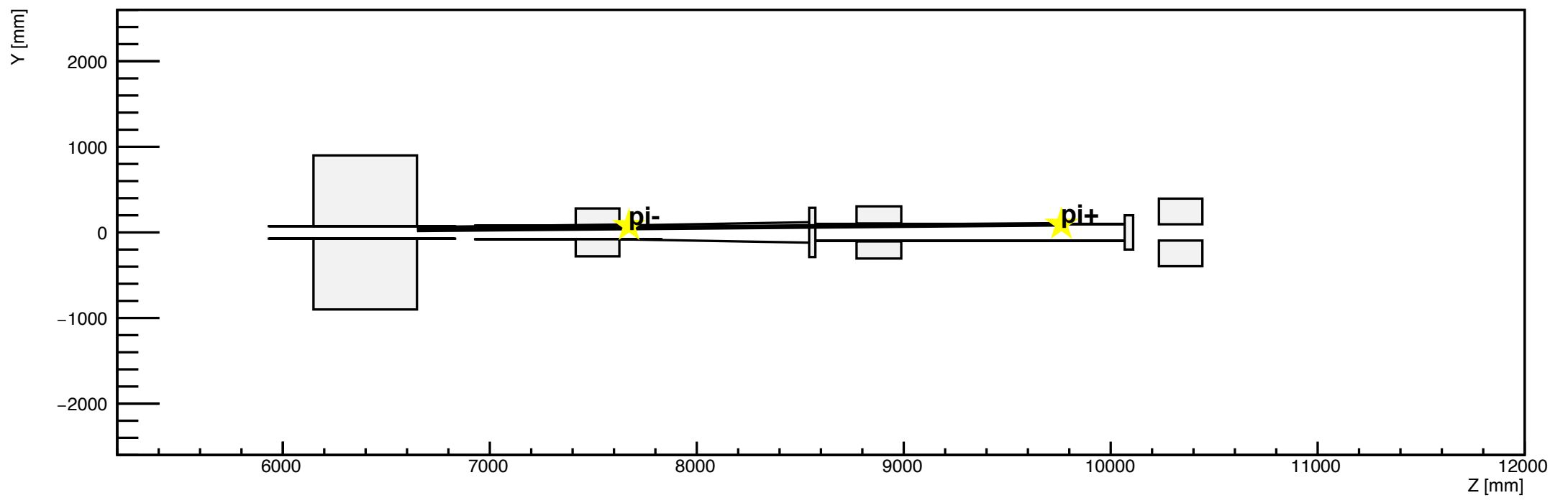

h2

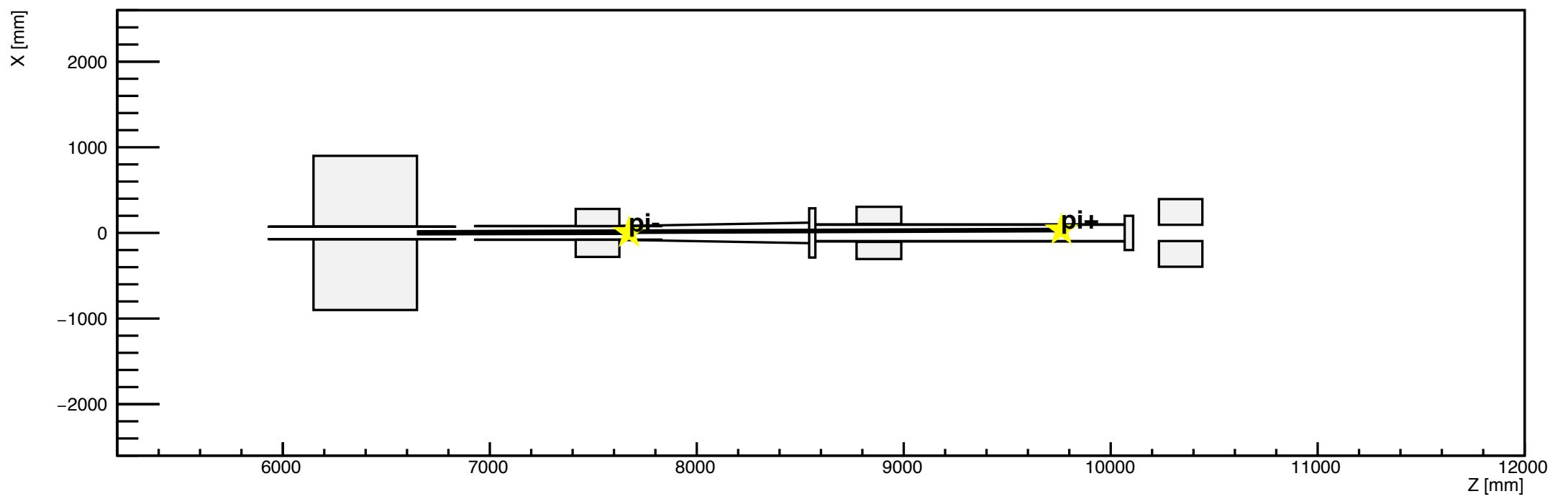

h1

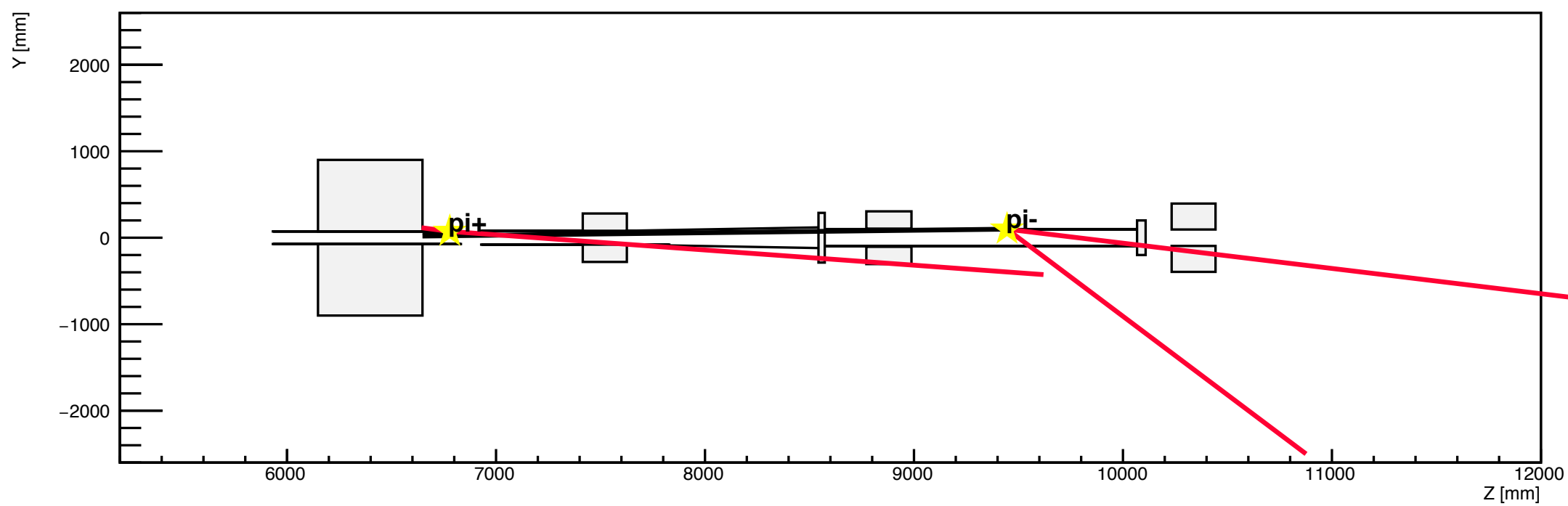

h2

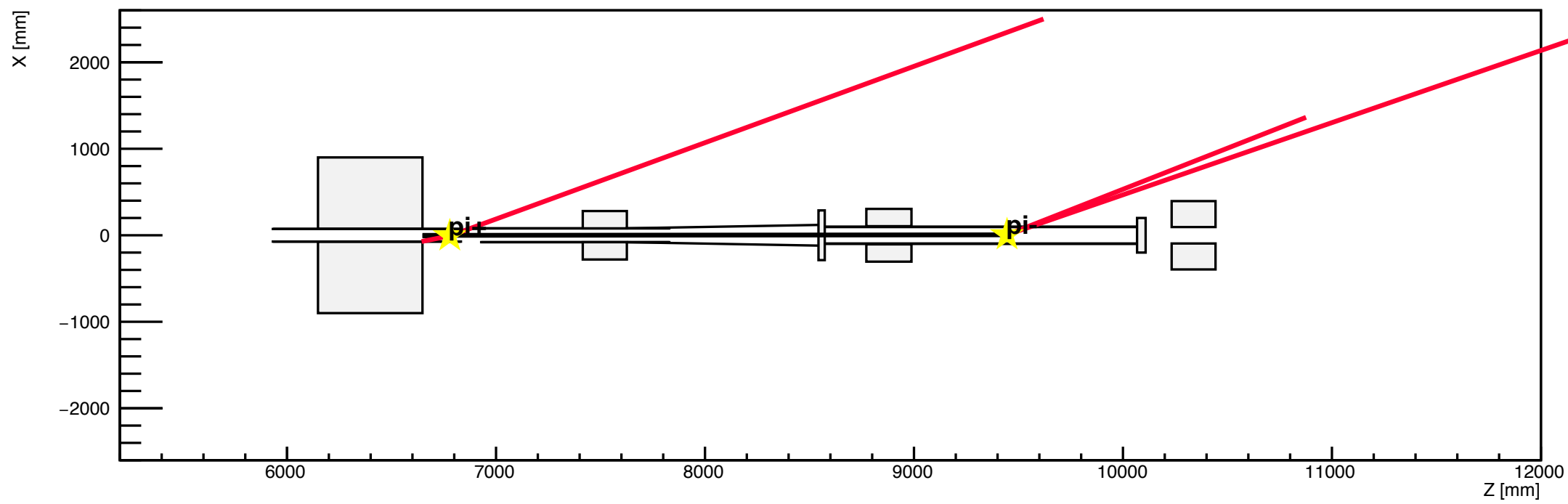

h1

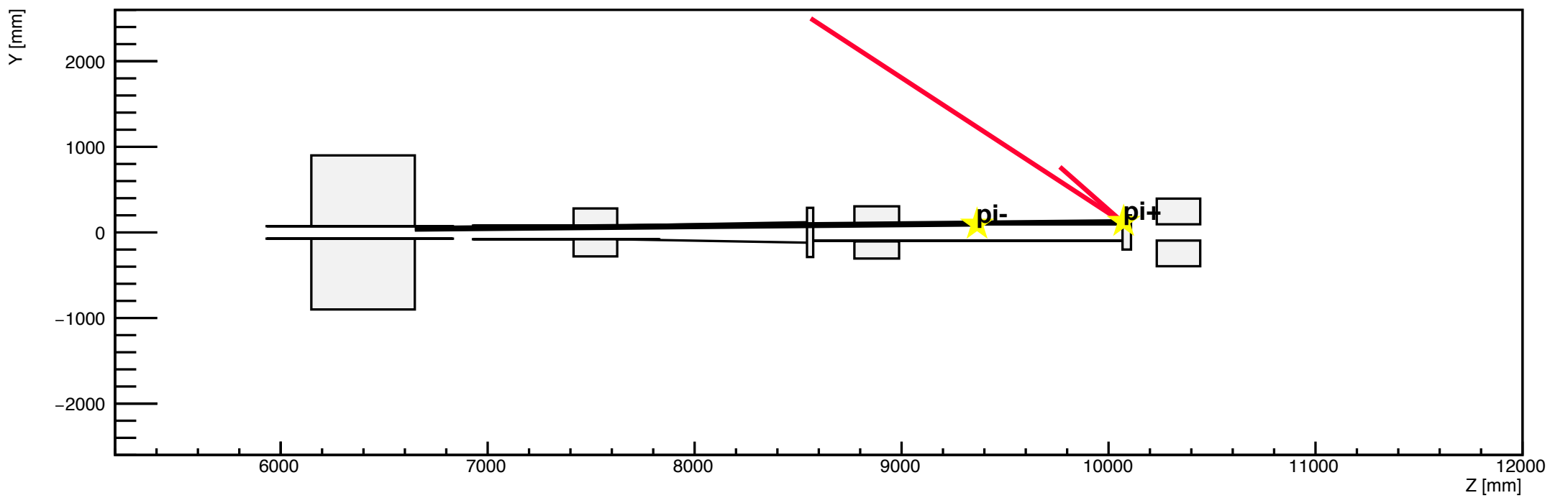

h2

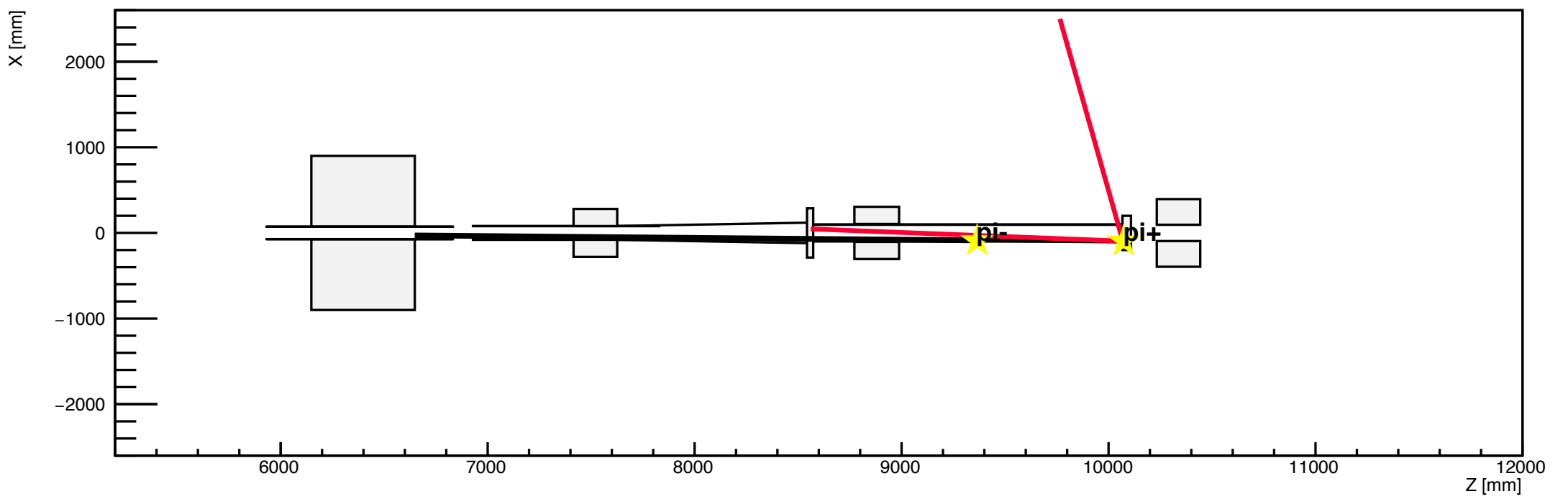

h1

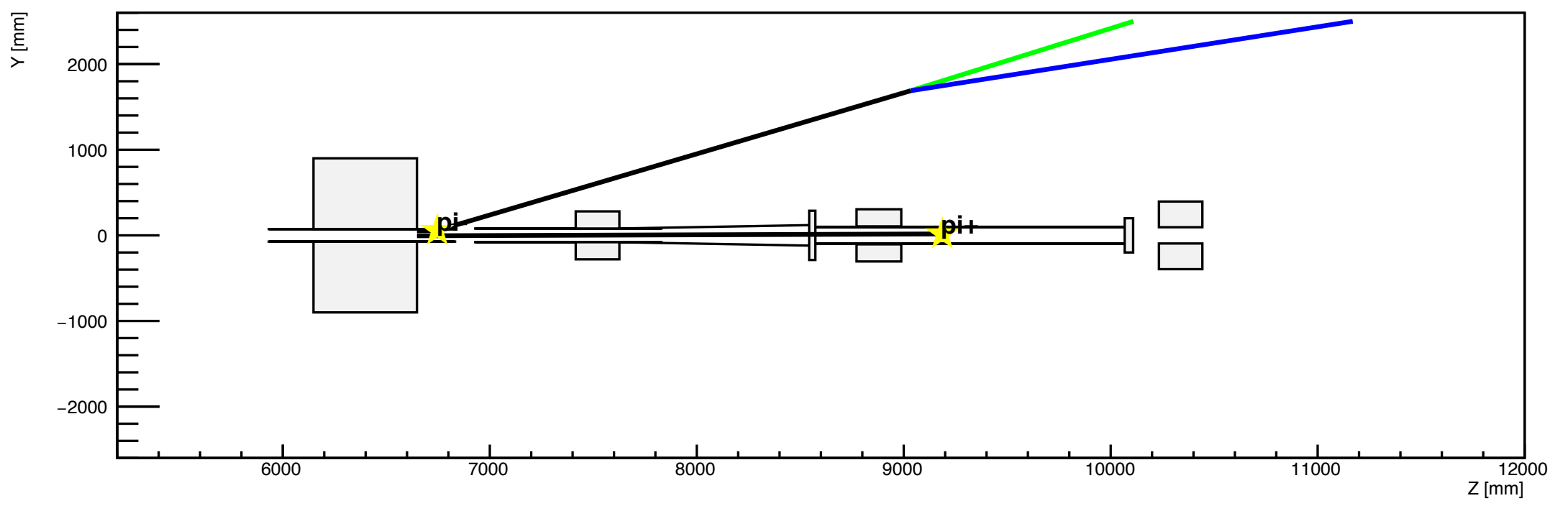

h2

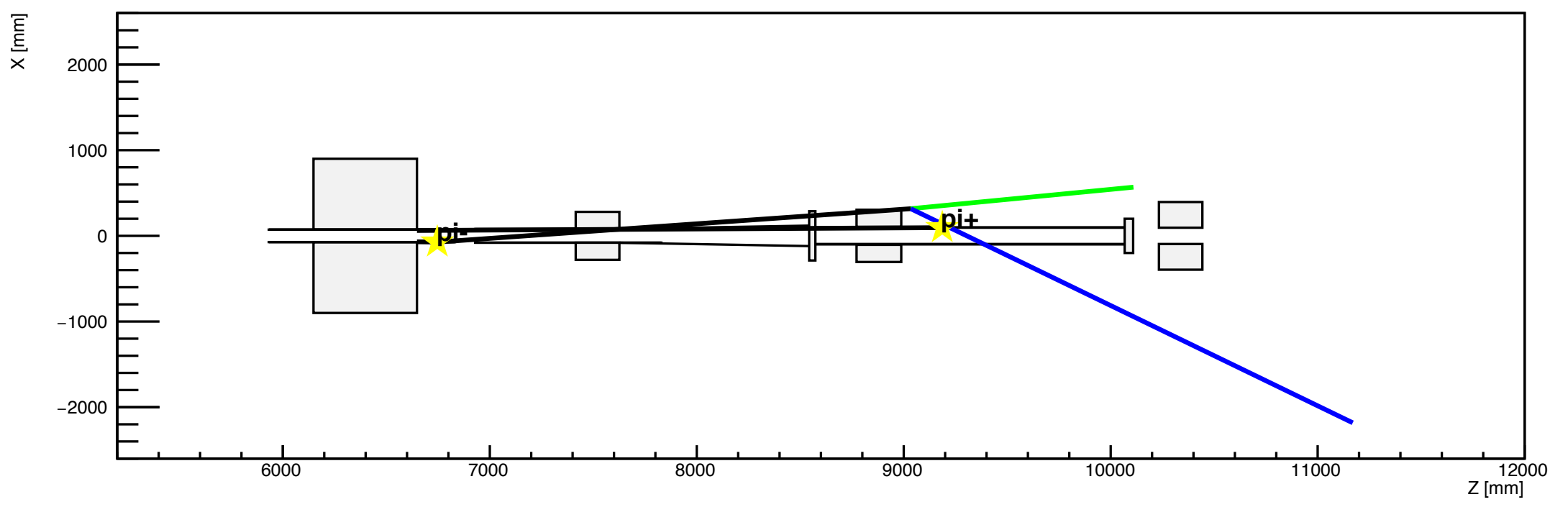

h1

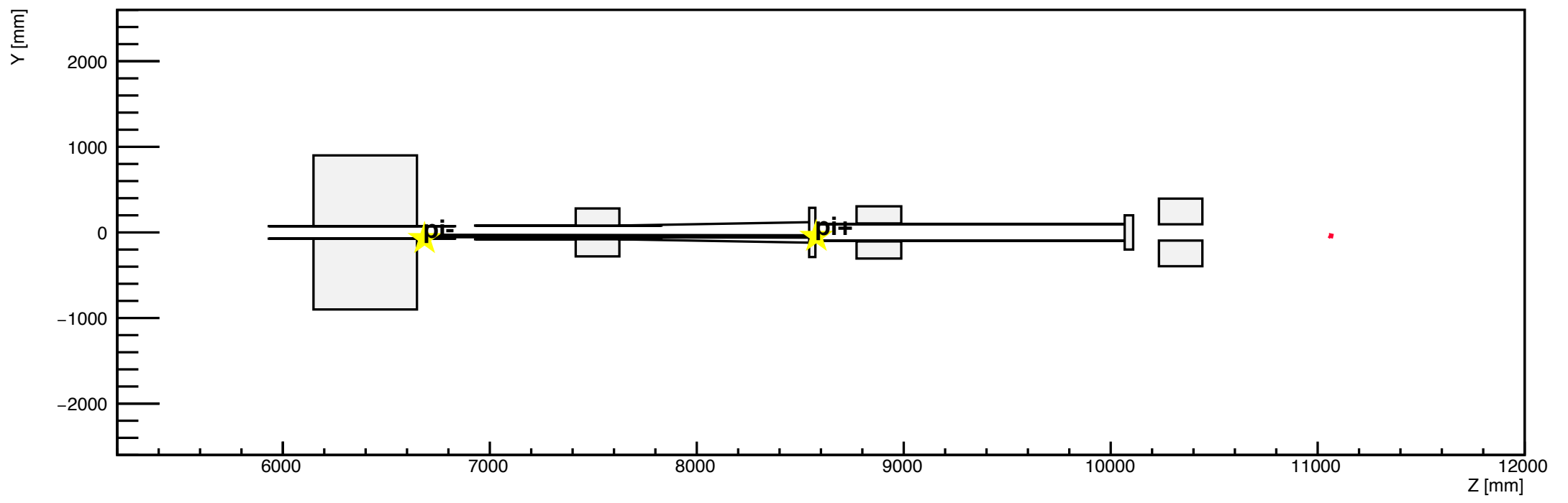

h2

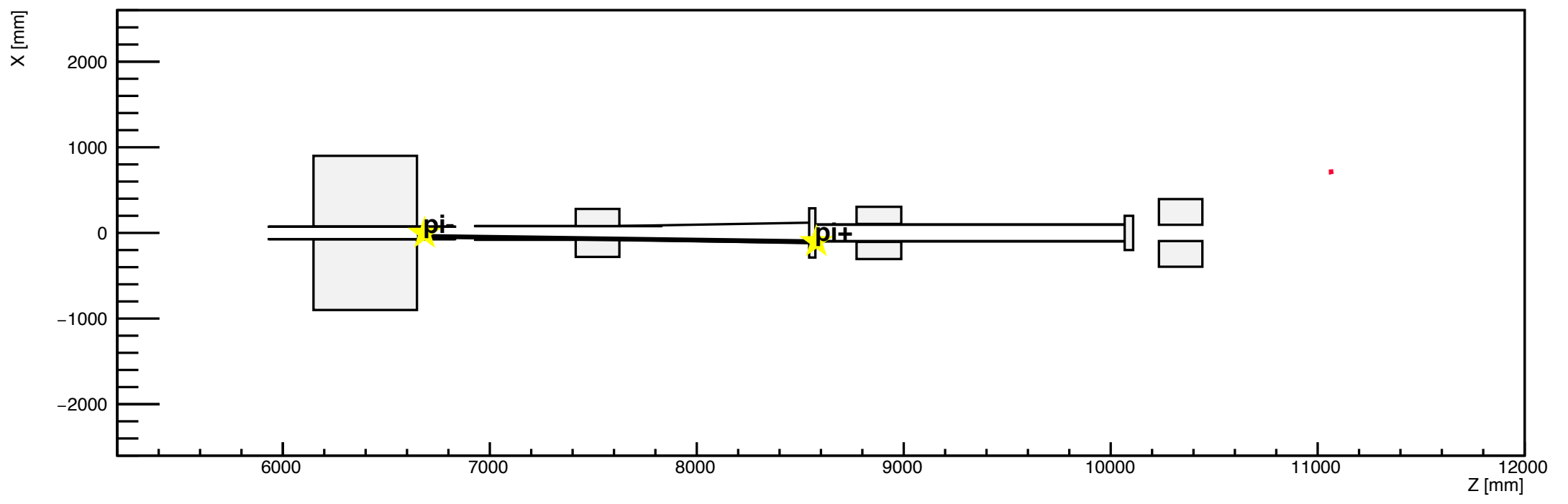

h1

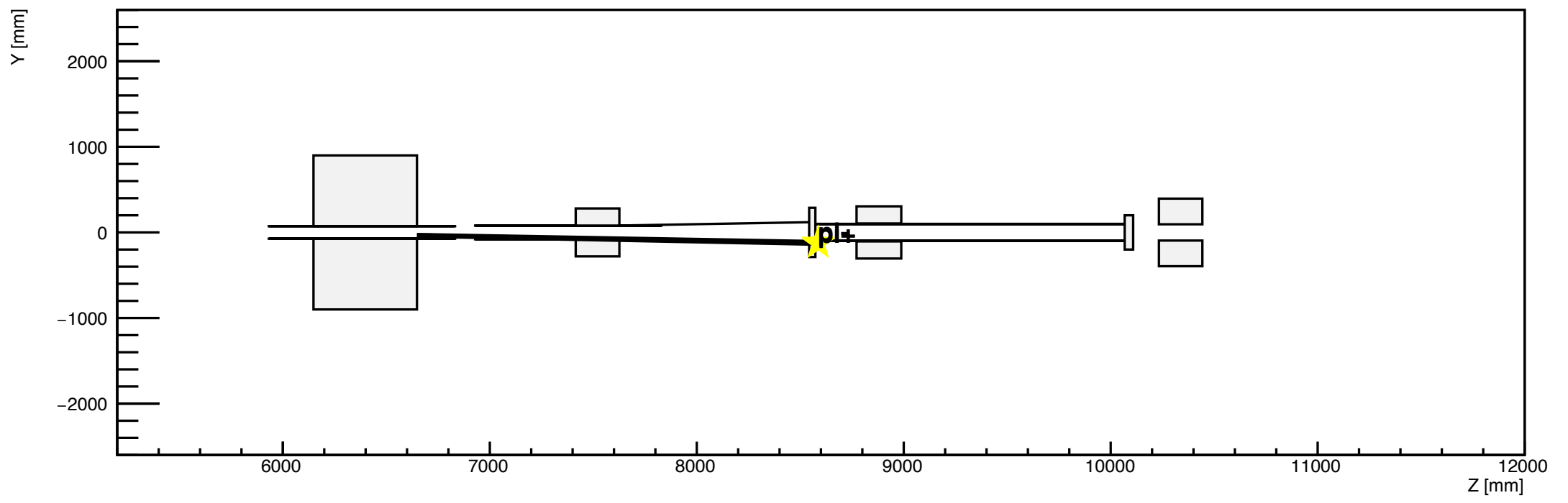

h2

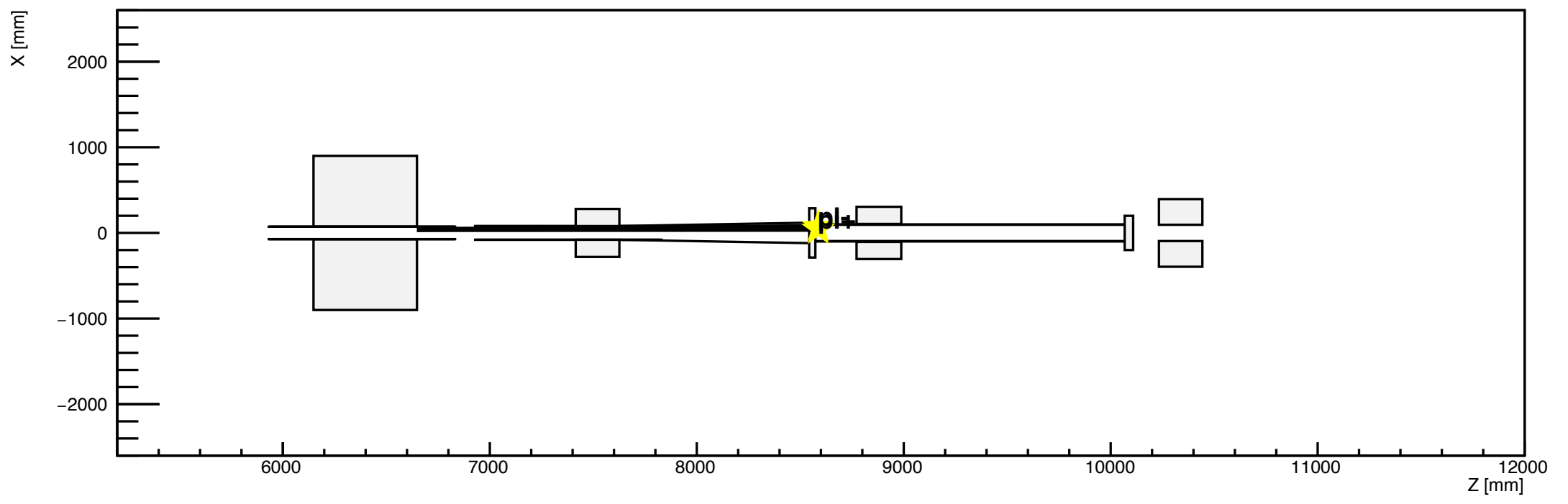

h1

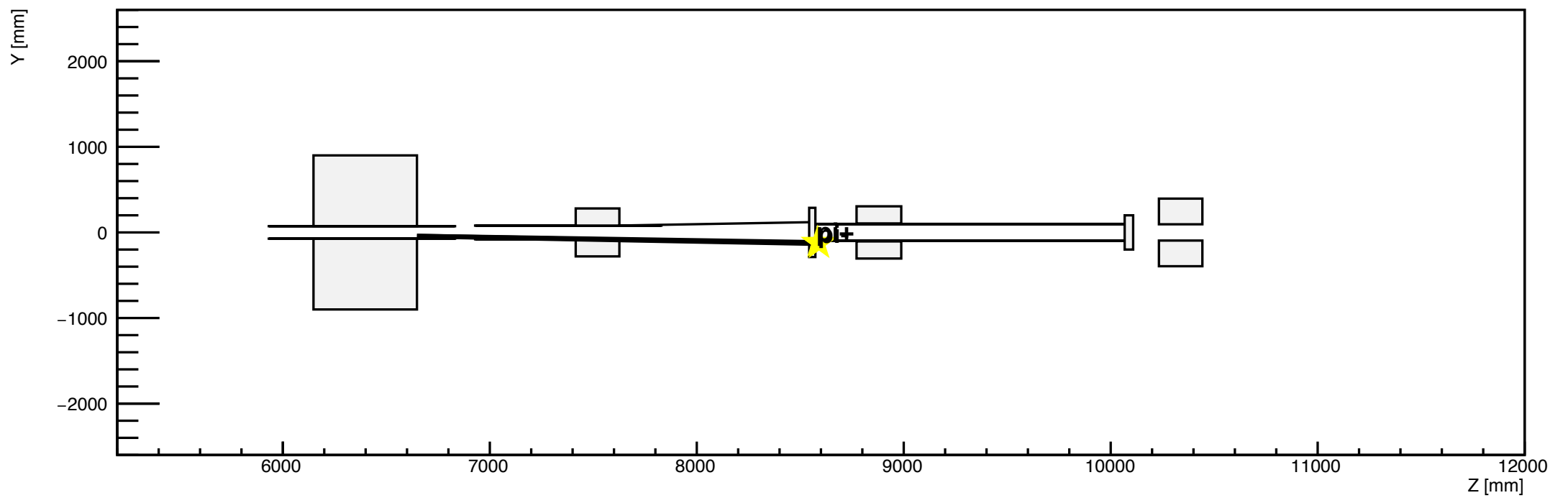

h2

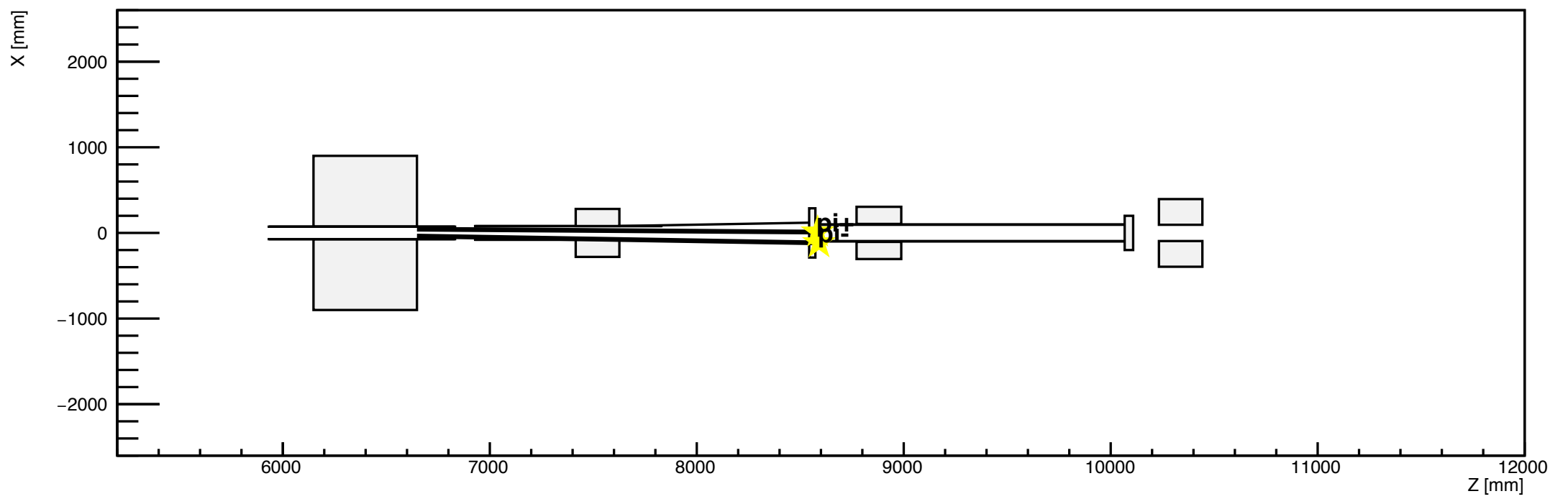

h1

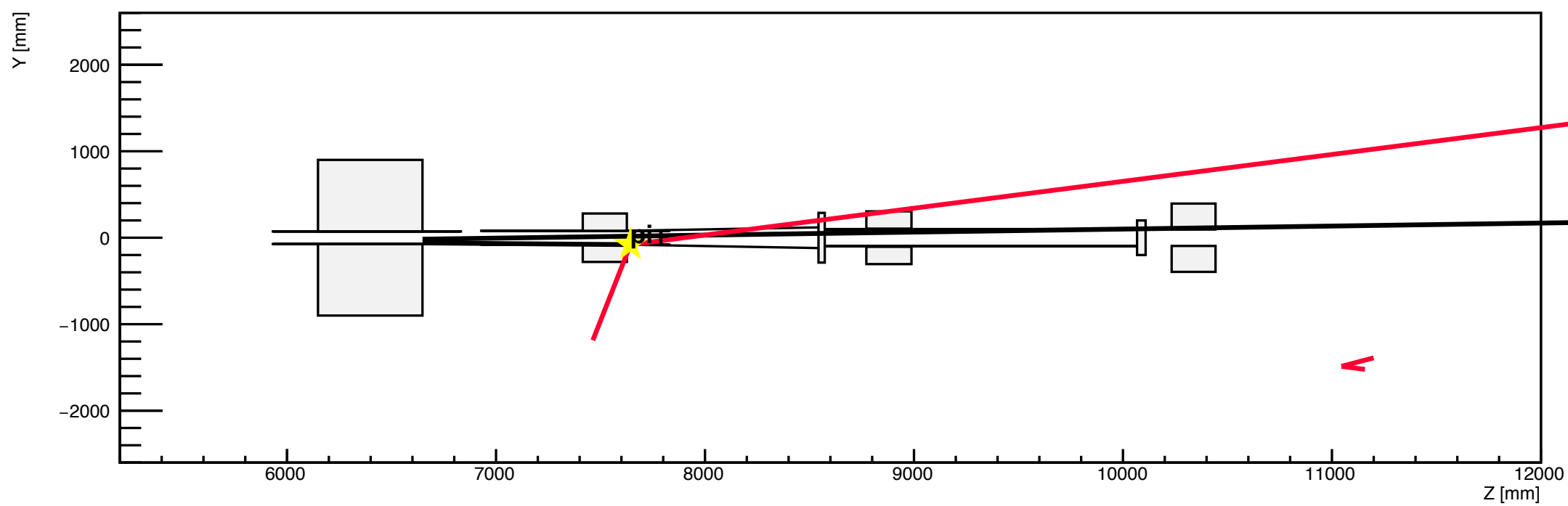

h2

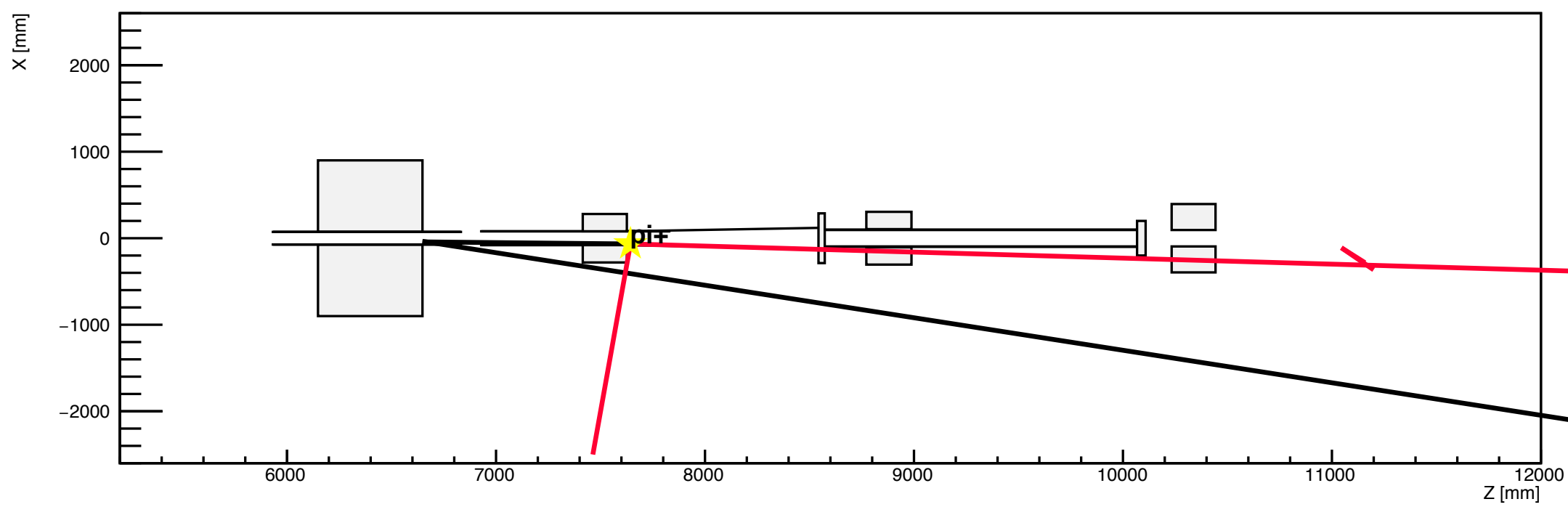

h1

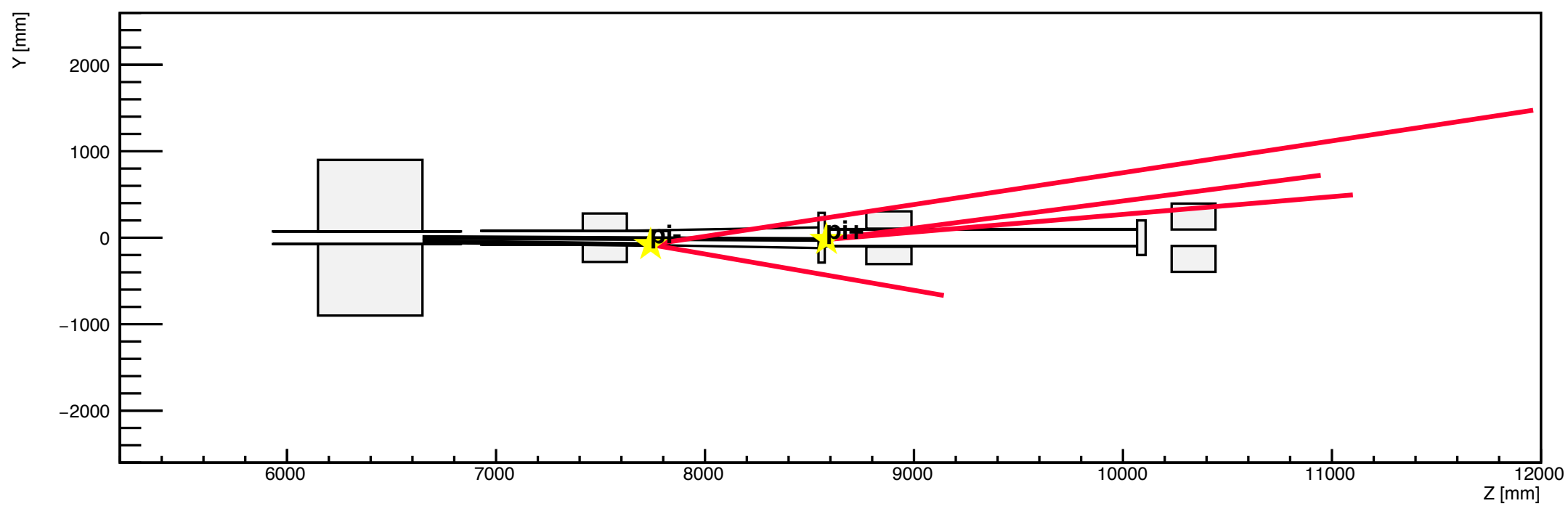

h2

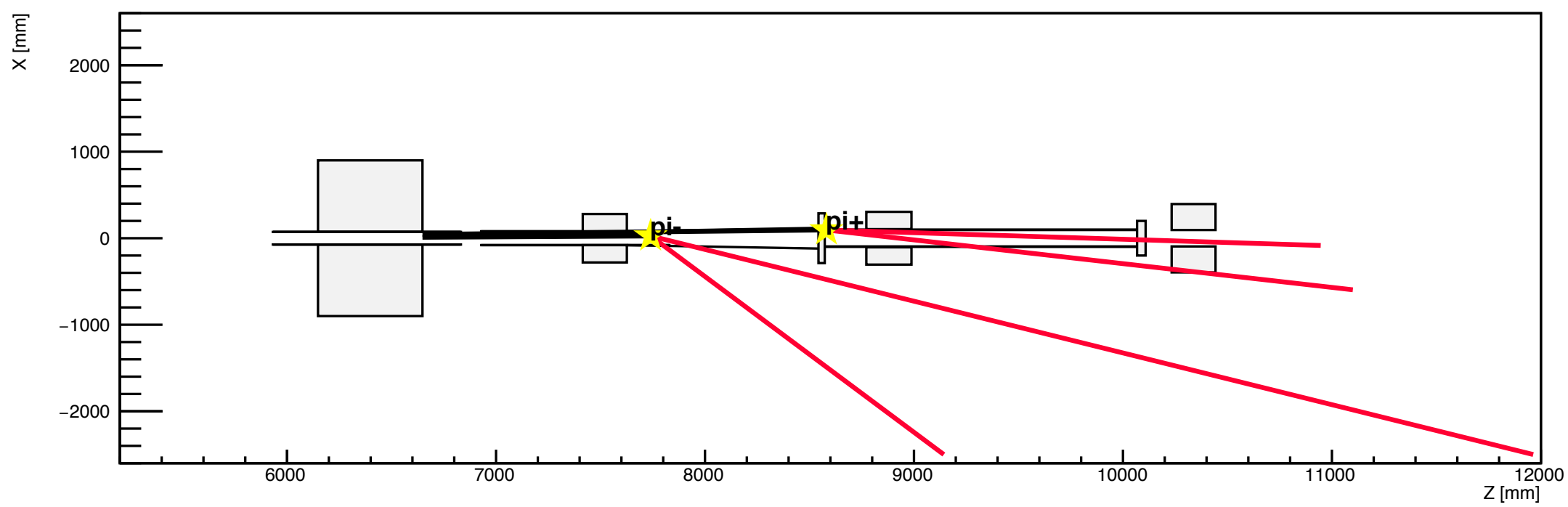

h1

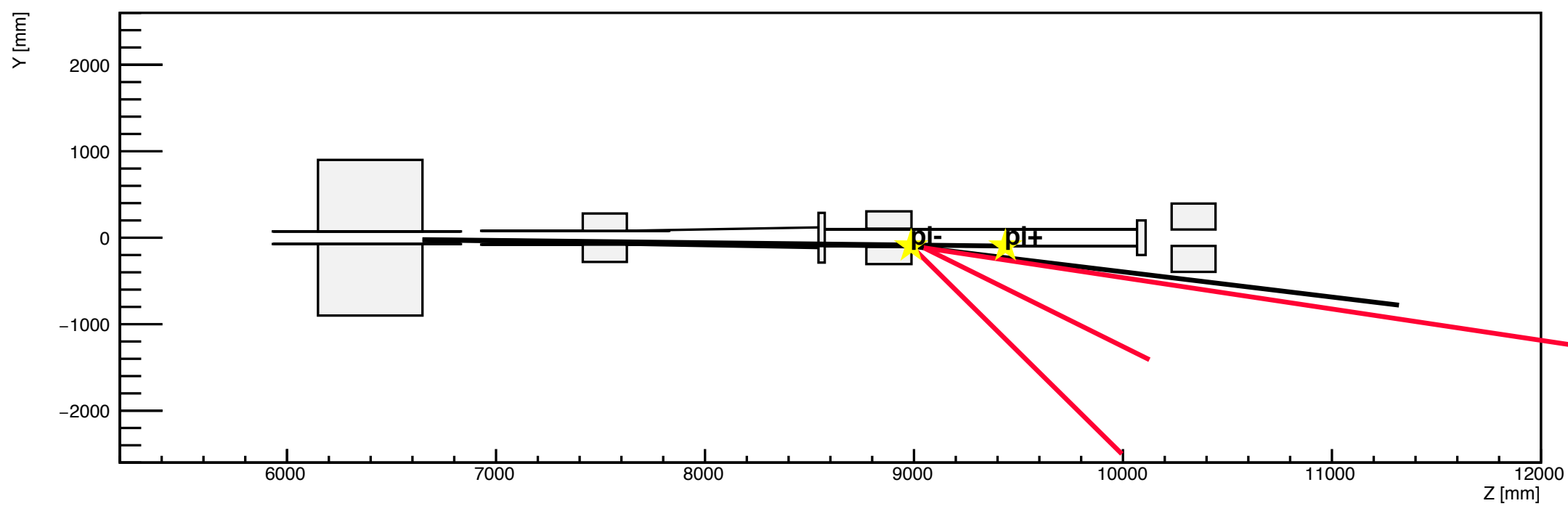

h2

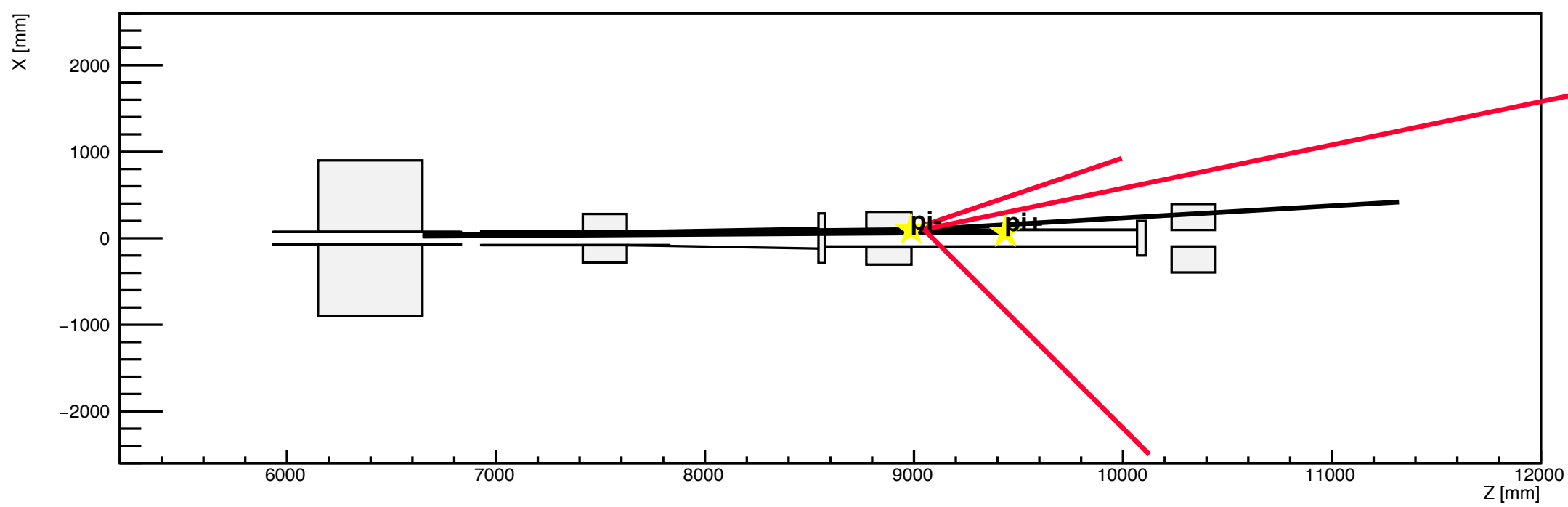

h1

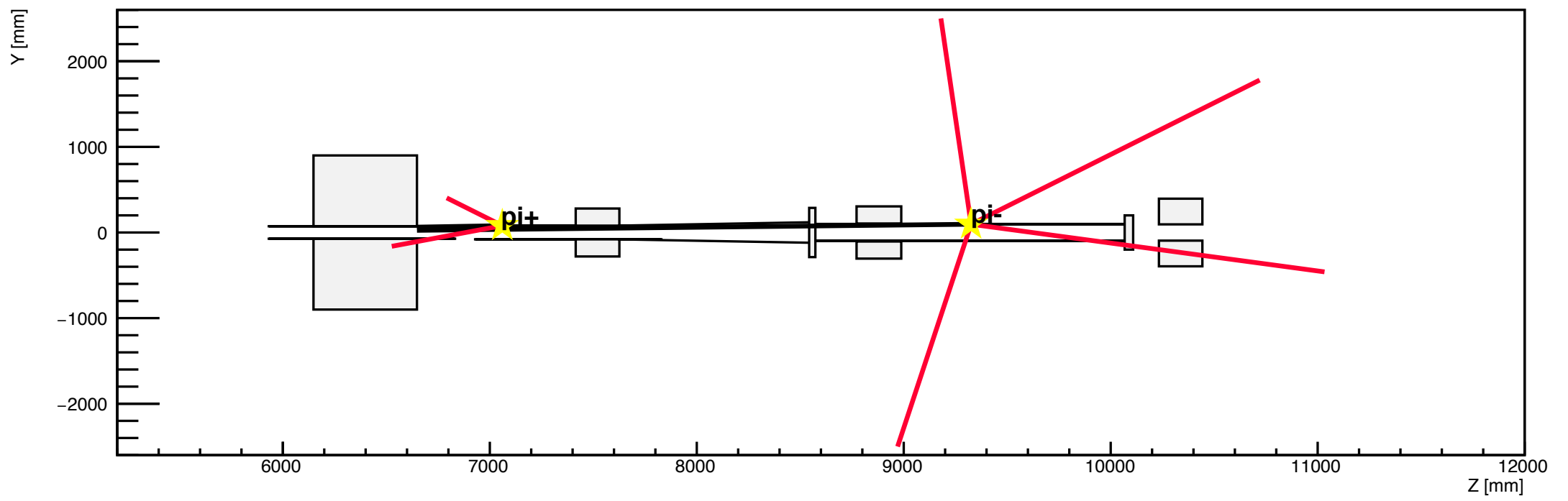

h2

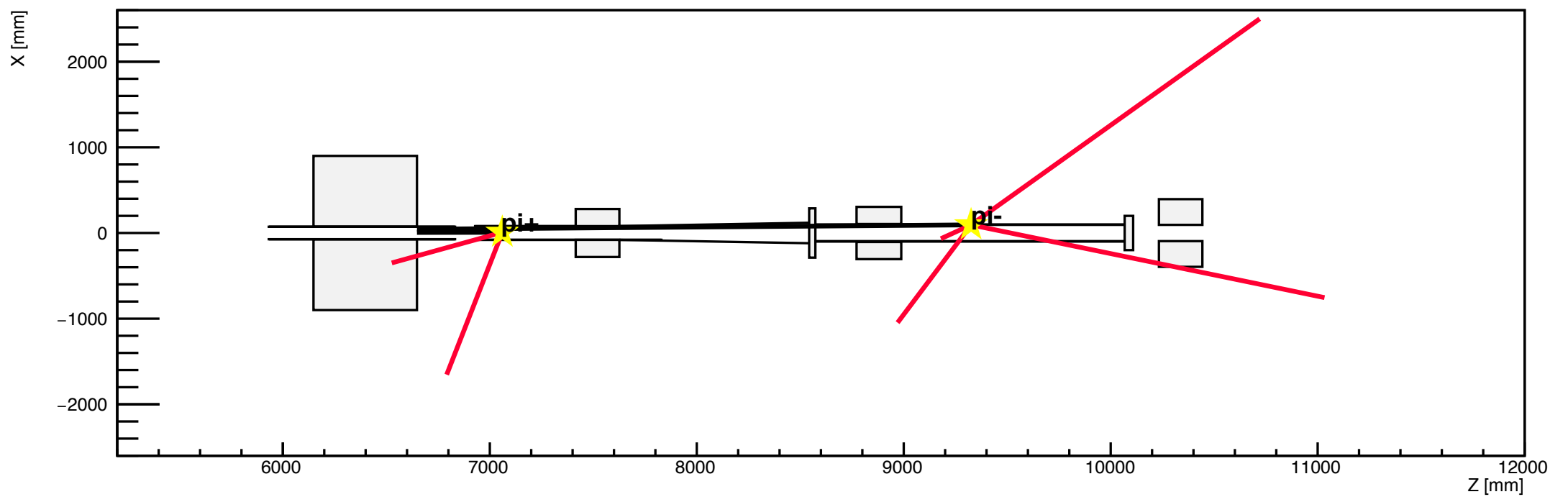

h1

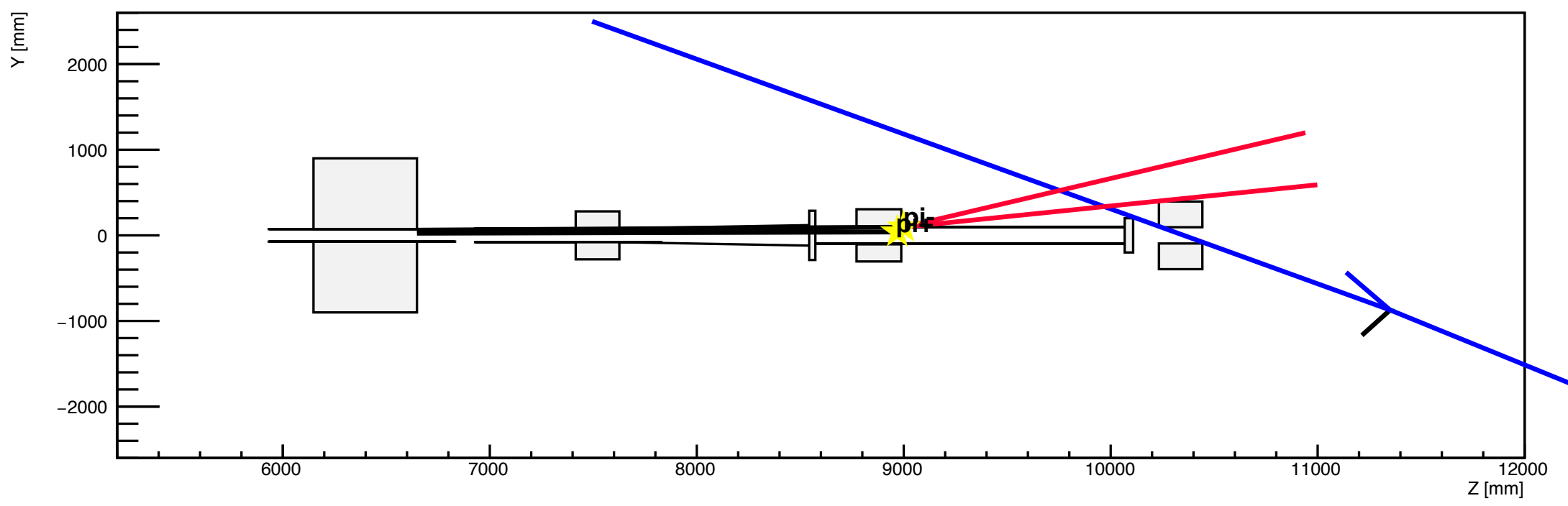

h2

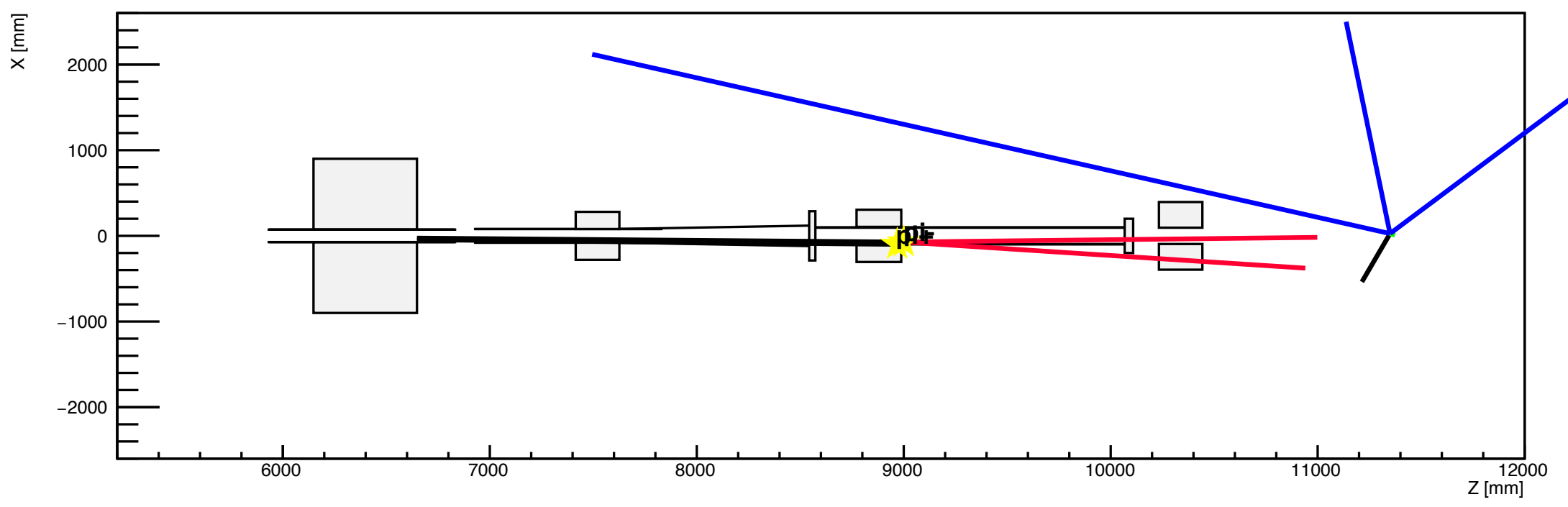

h1

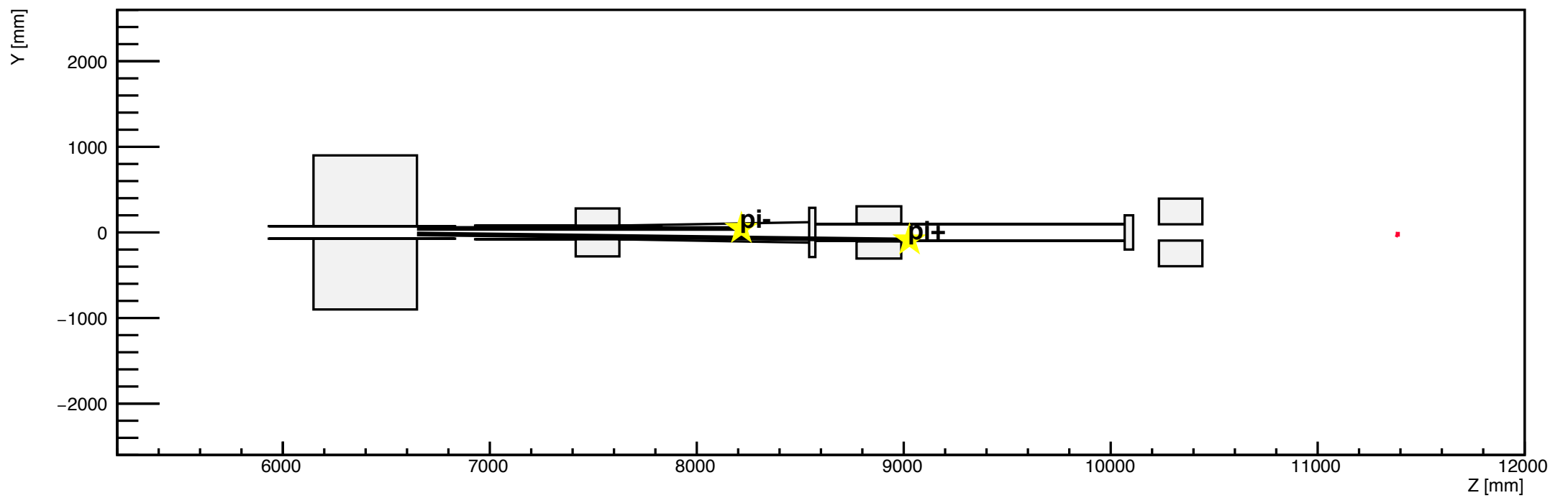

h2

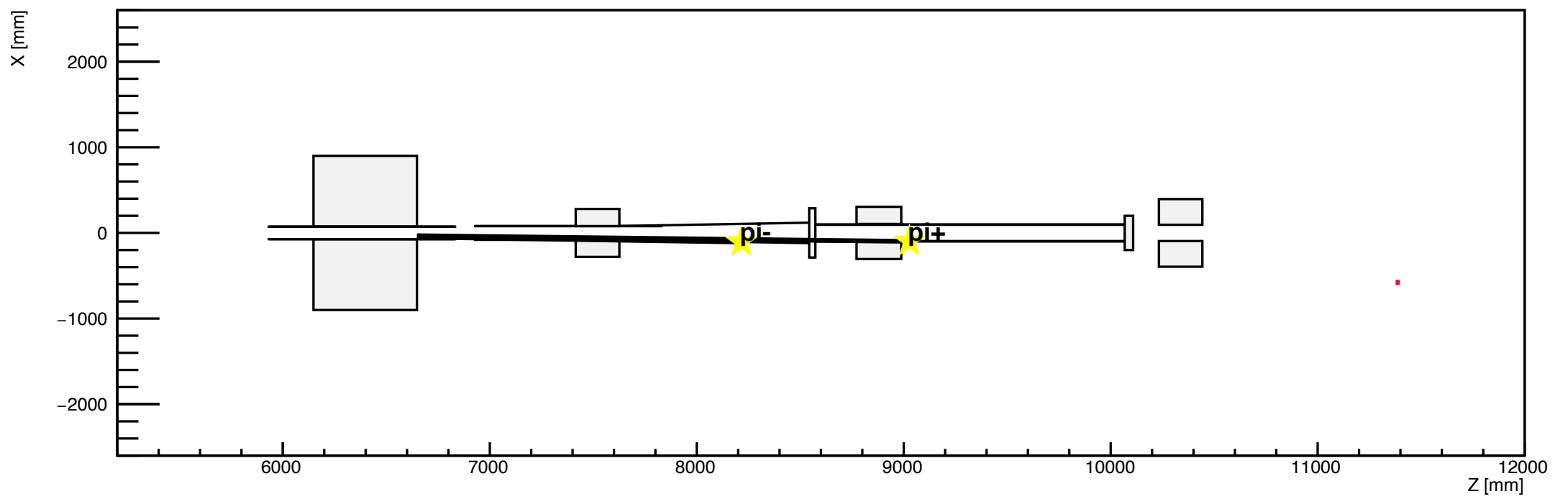

h1

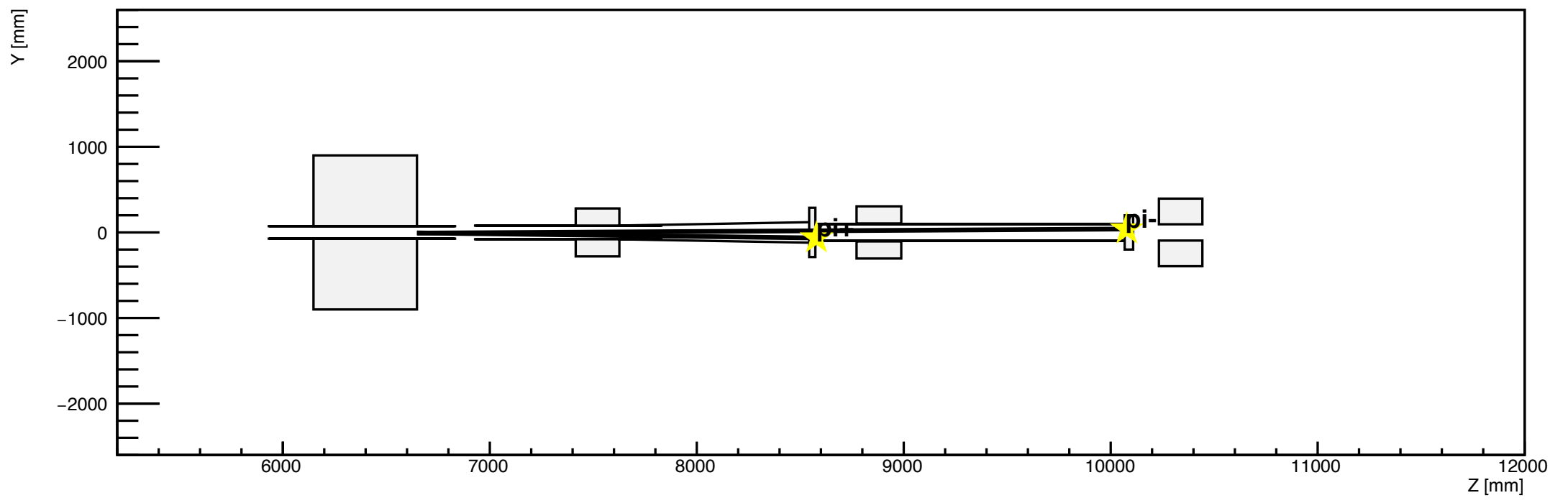

h2

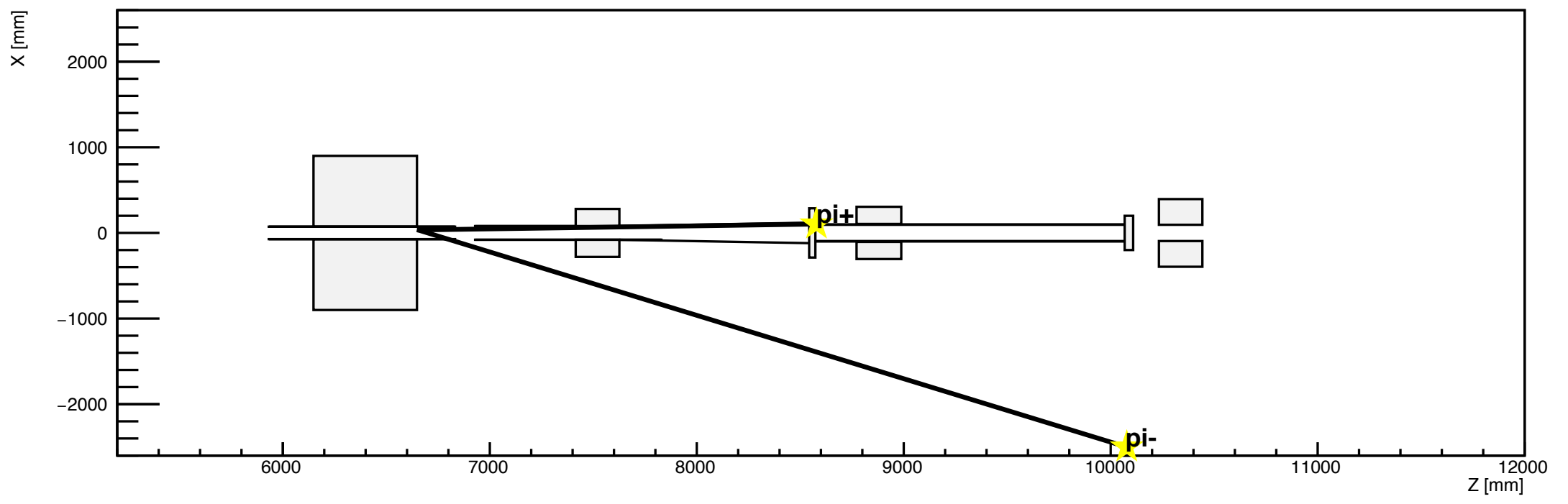

h1

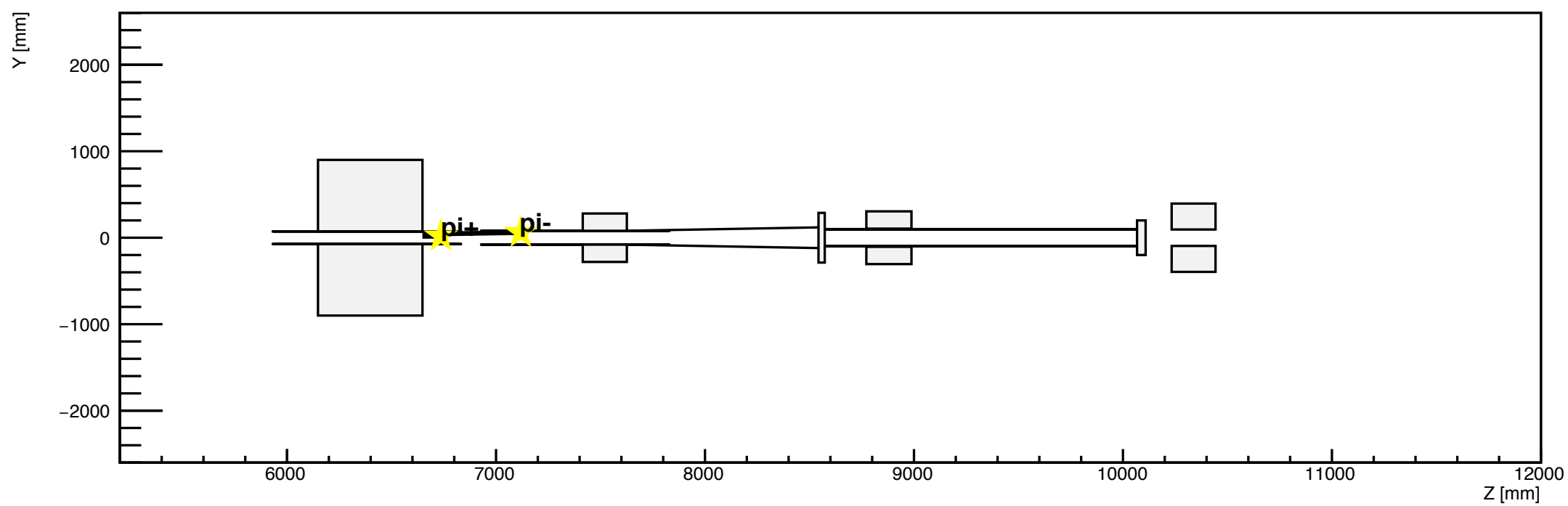

h2

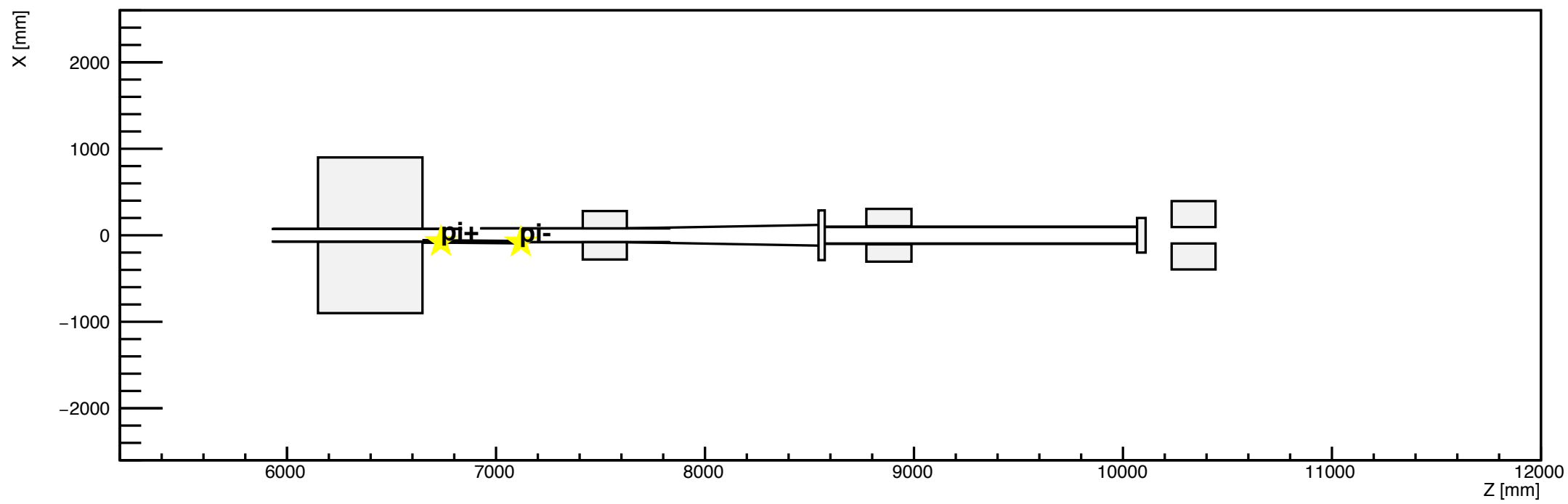

h1

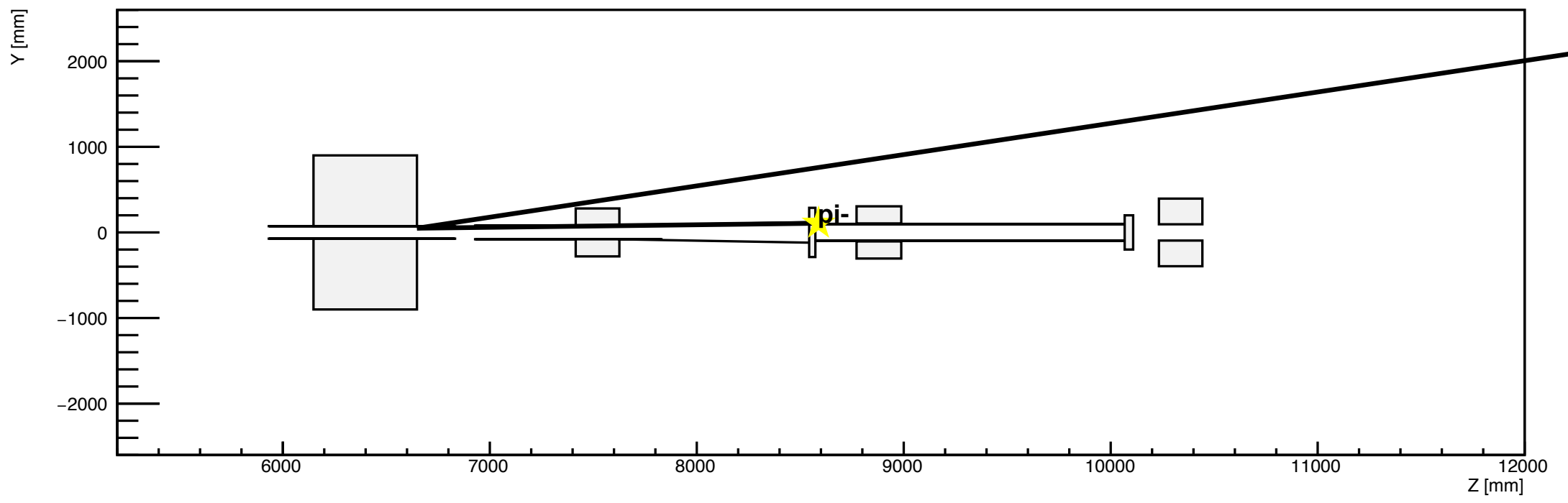

h2

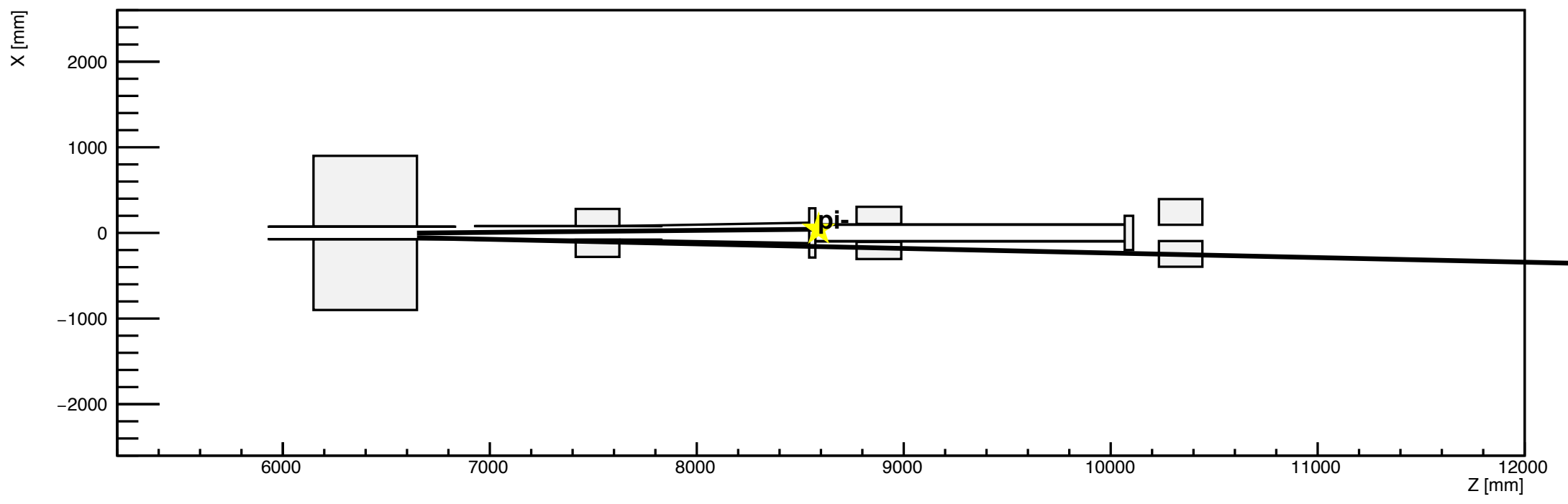

h1

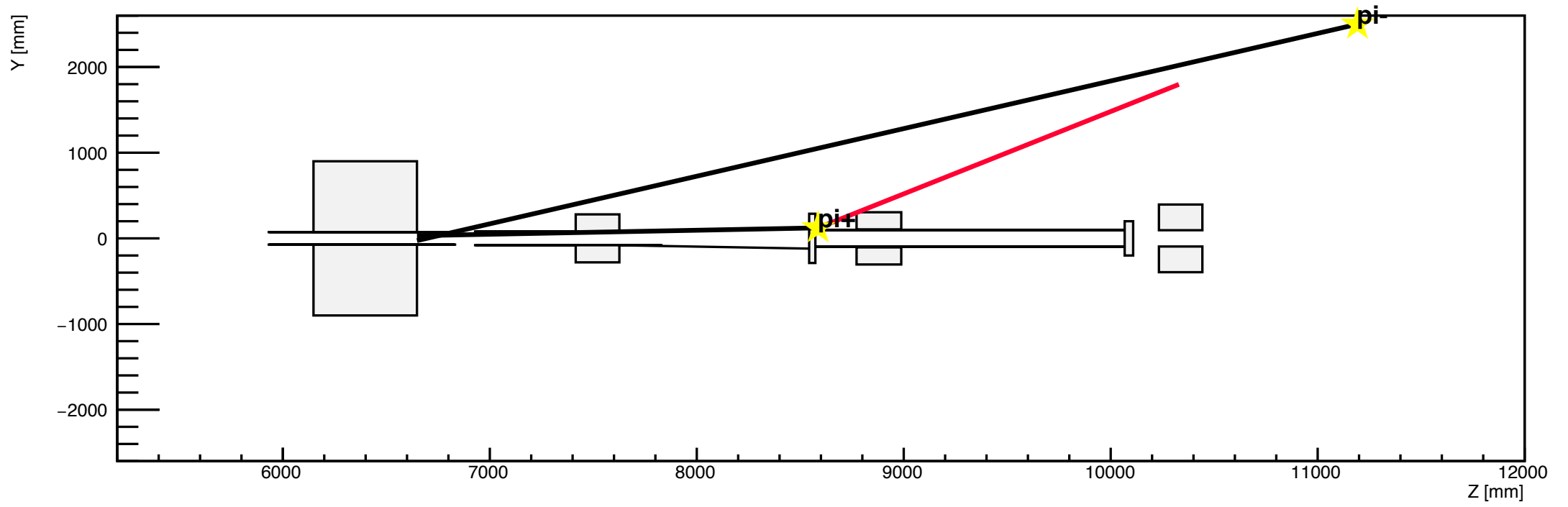

h2

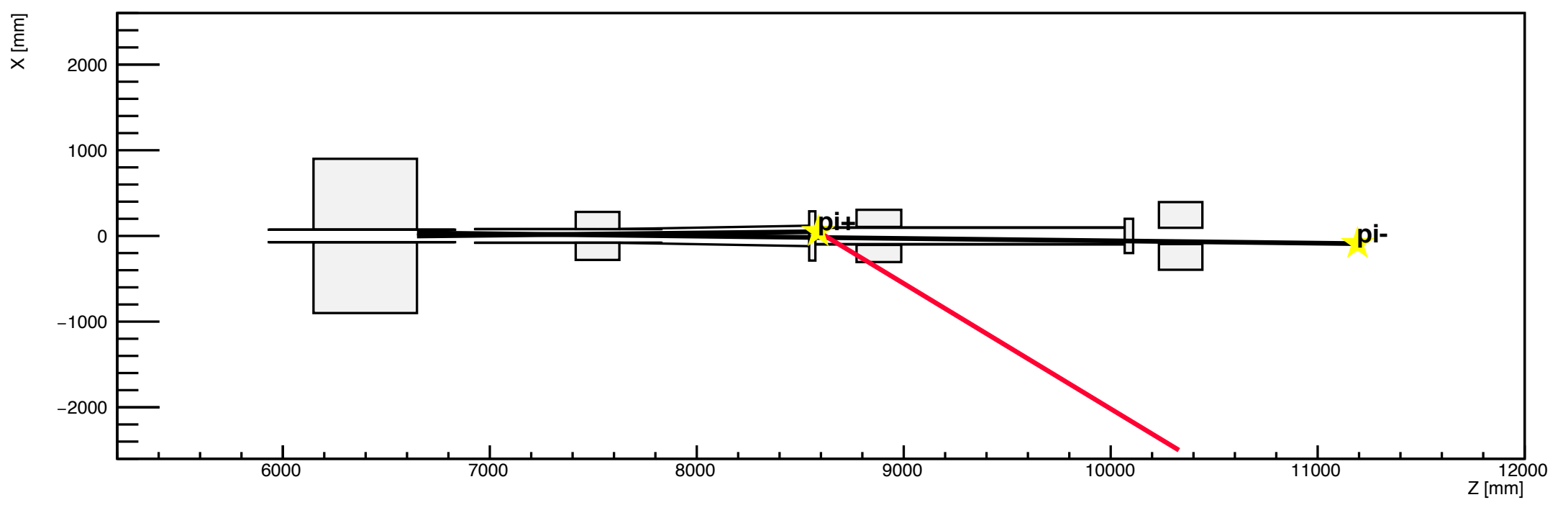

h1

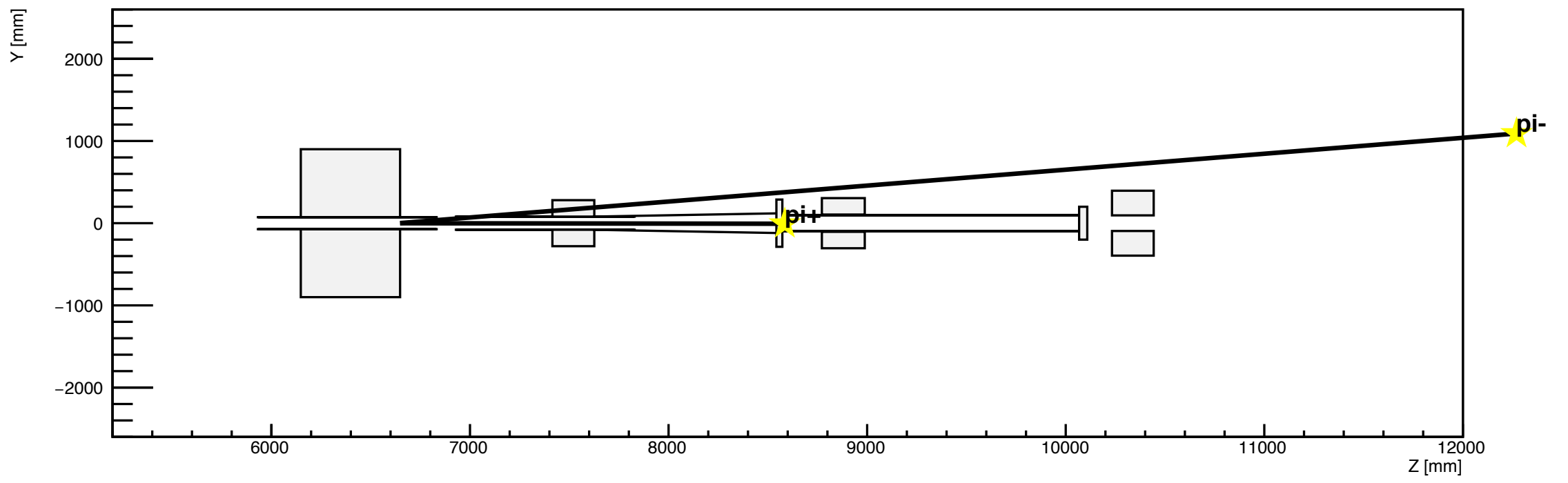

h2

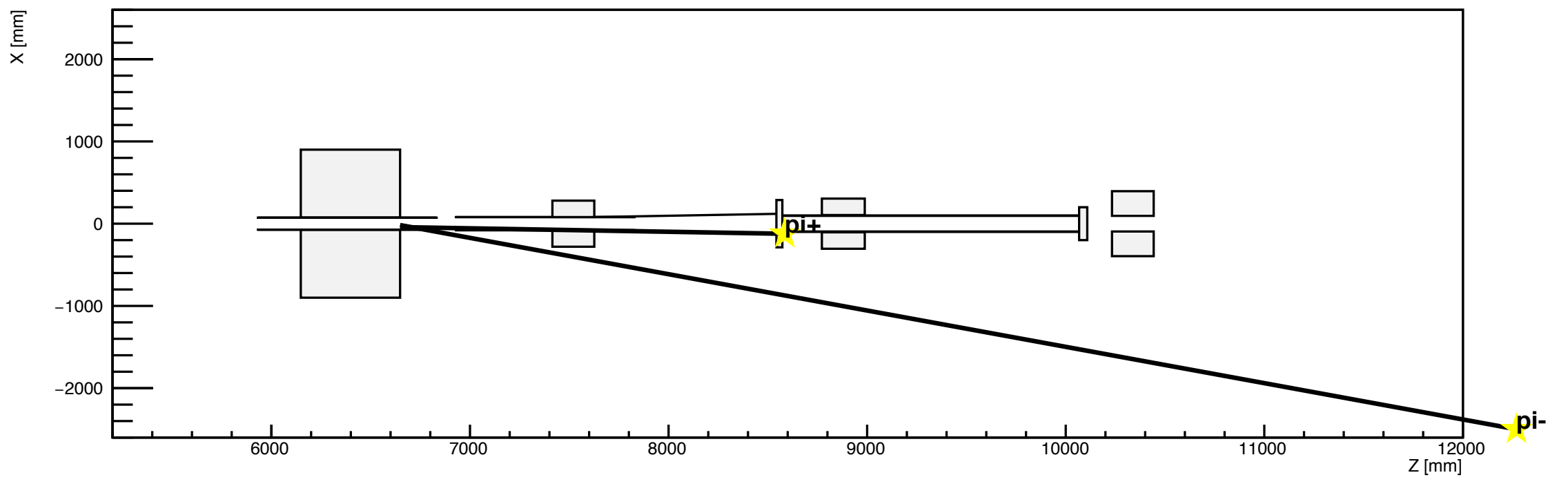

h1

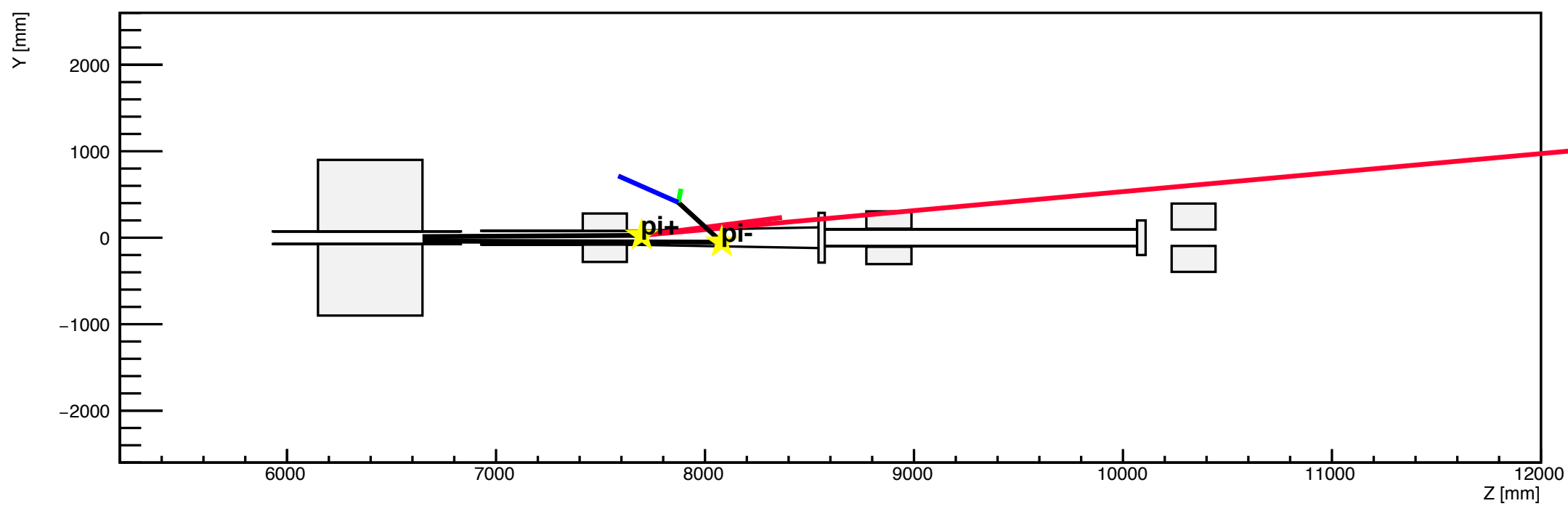

h2

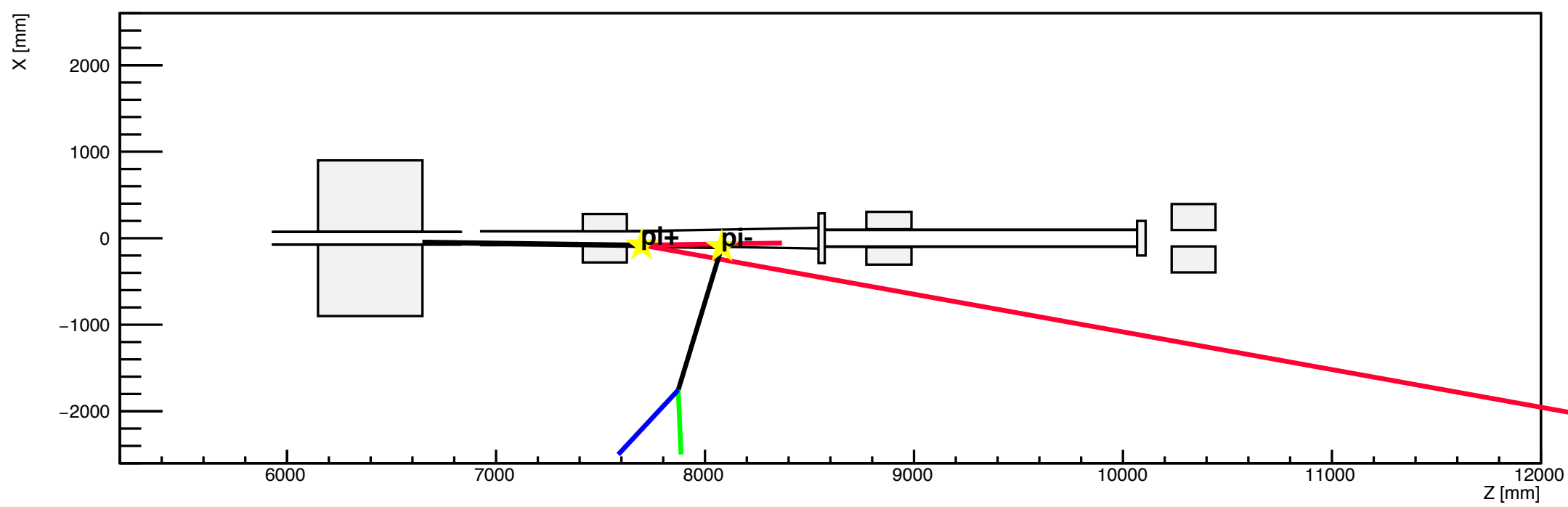

h1

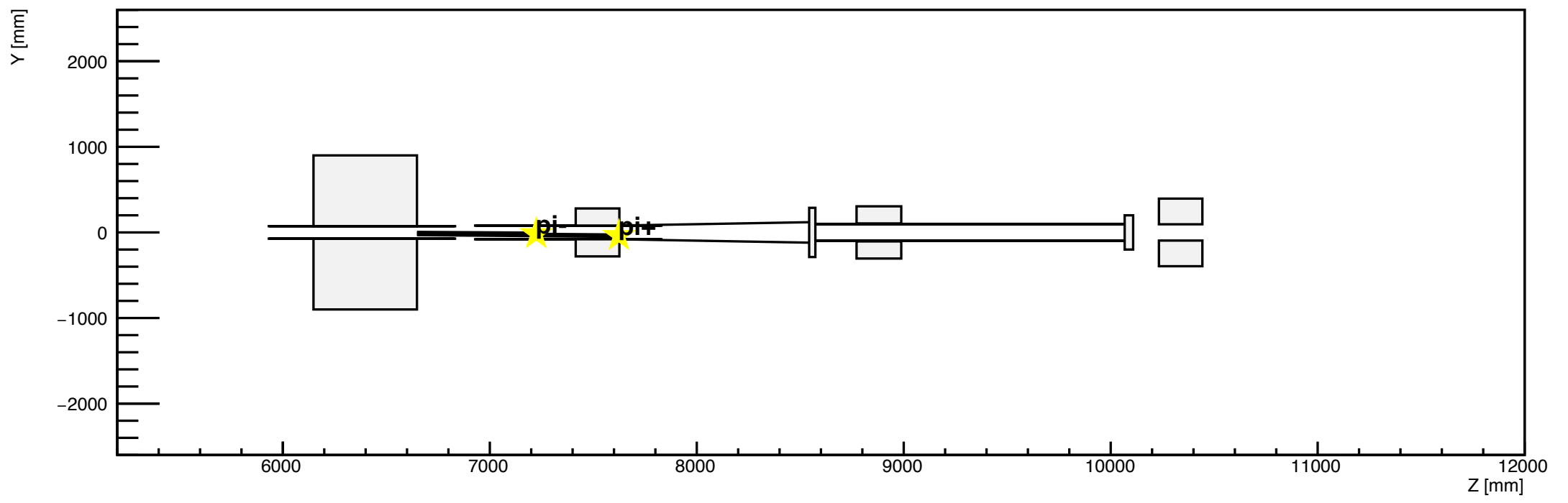

h2

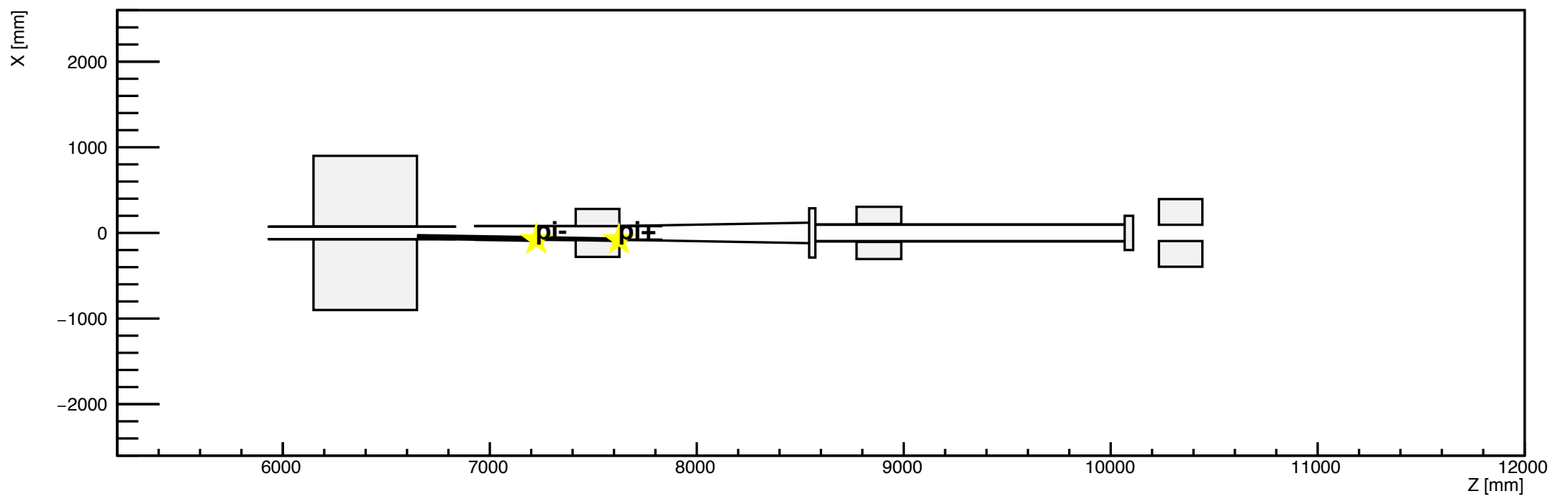

h1

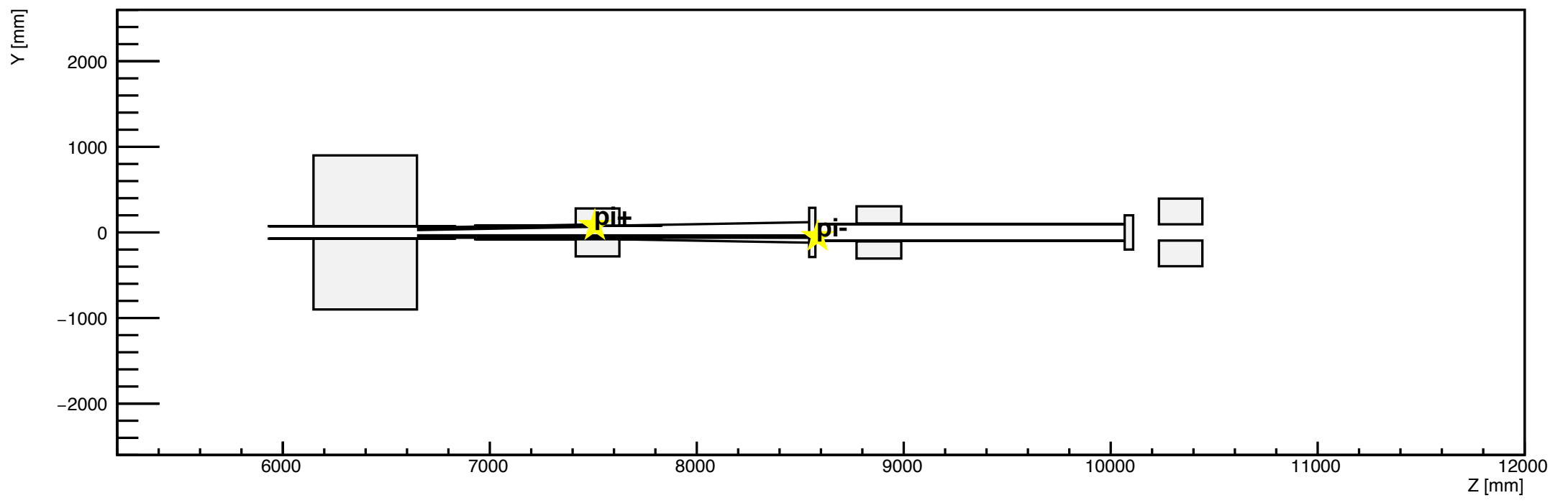

h2

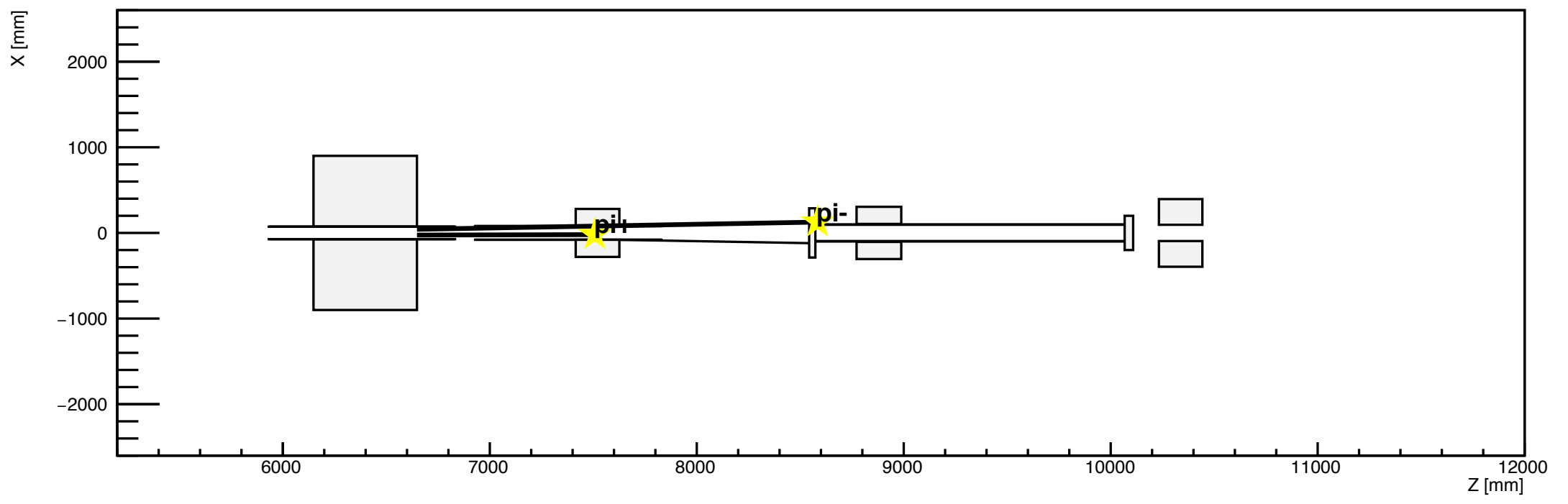

h1

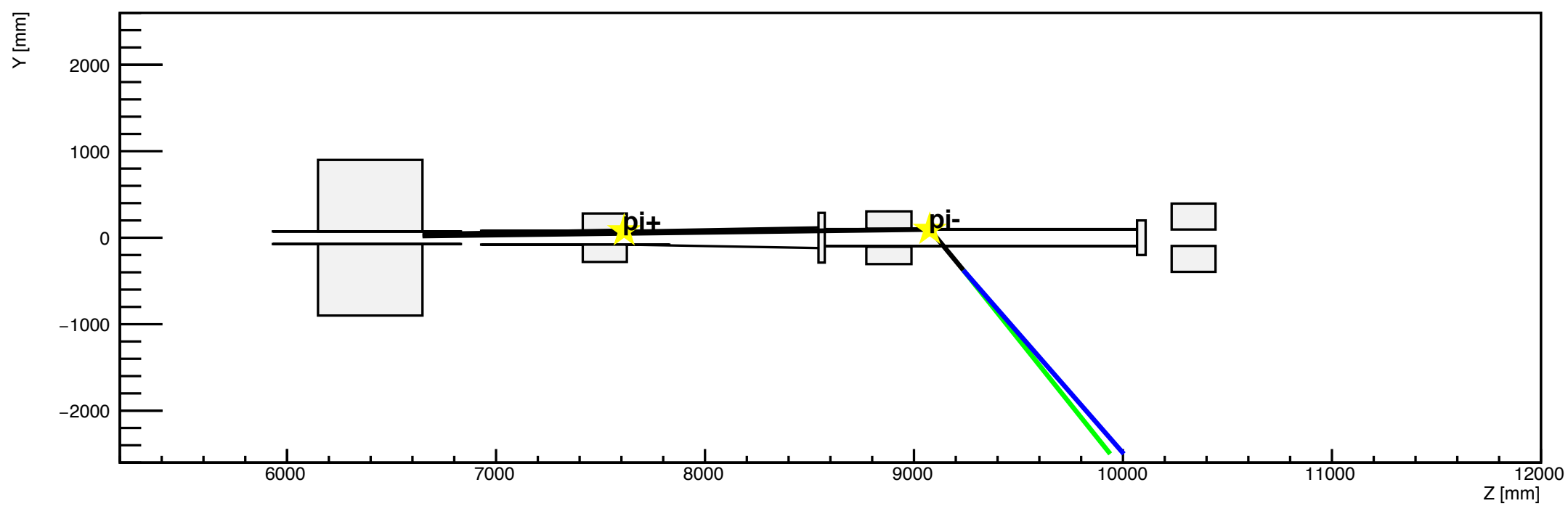

h2

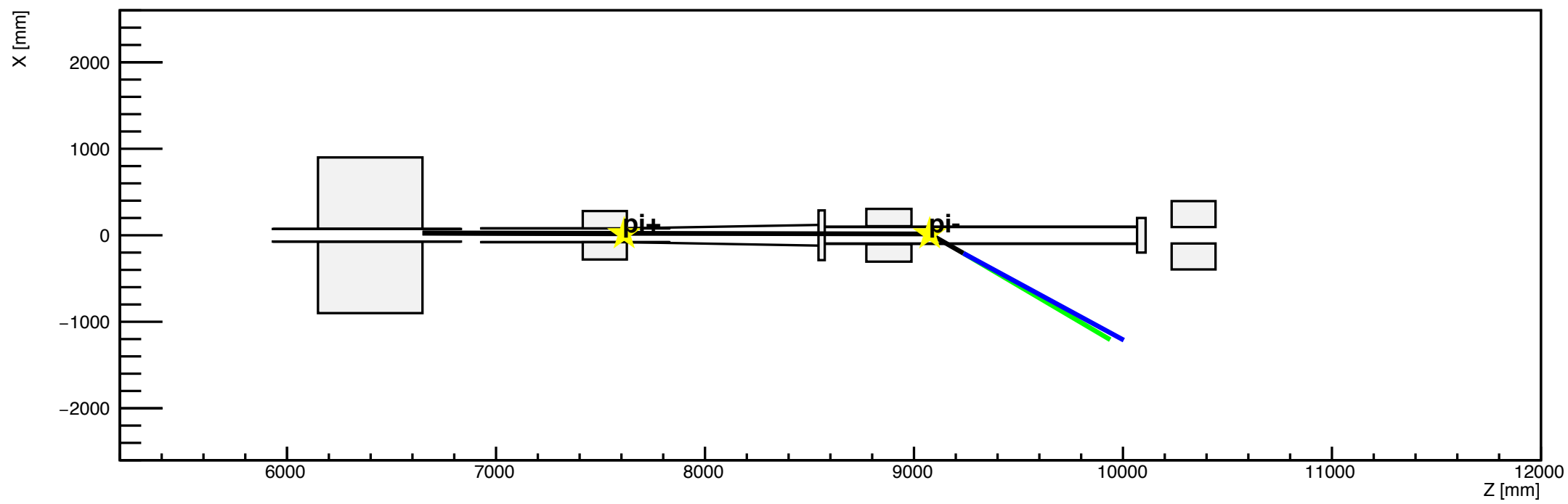

h1

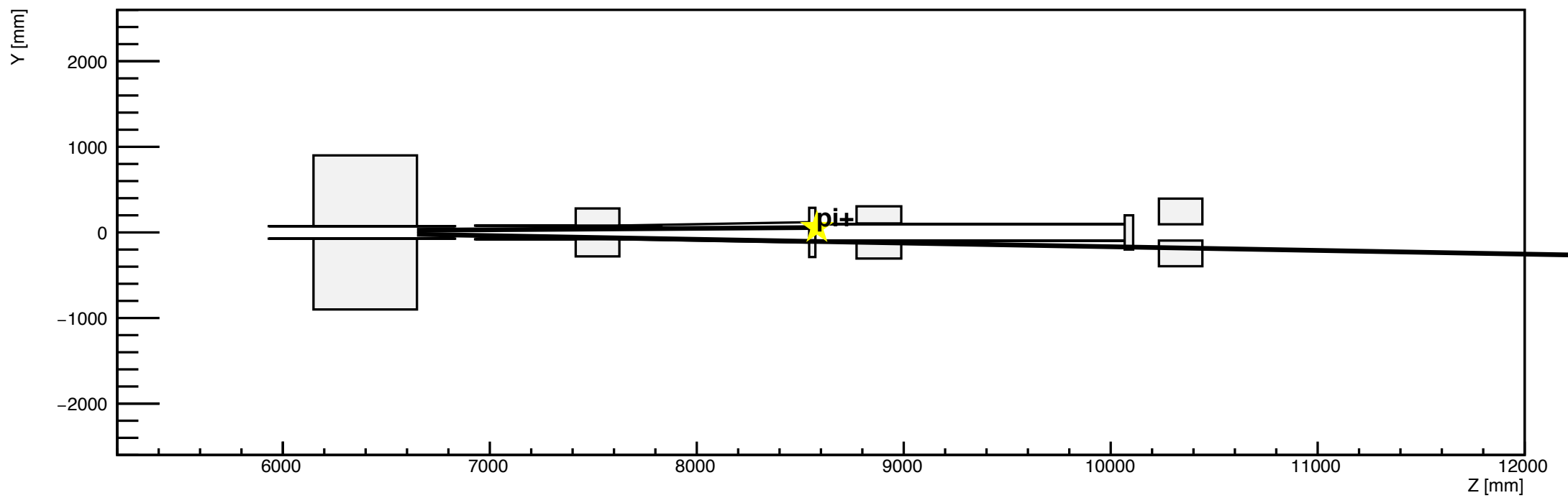

h2

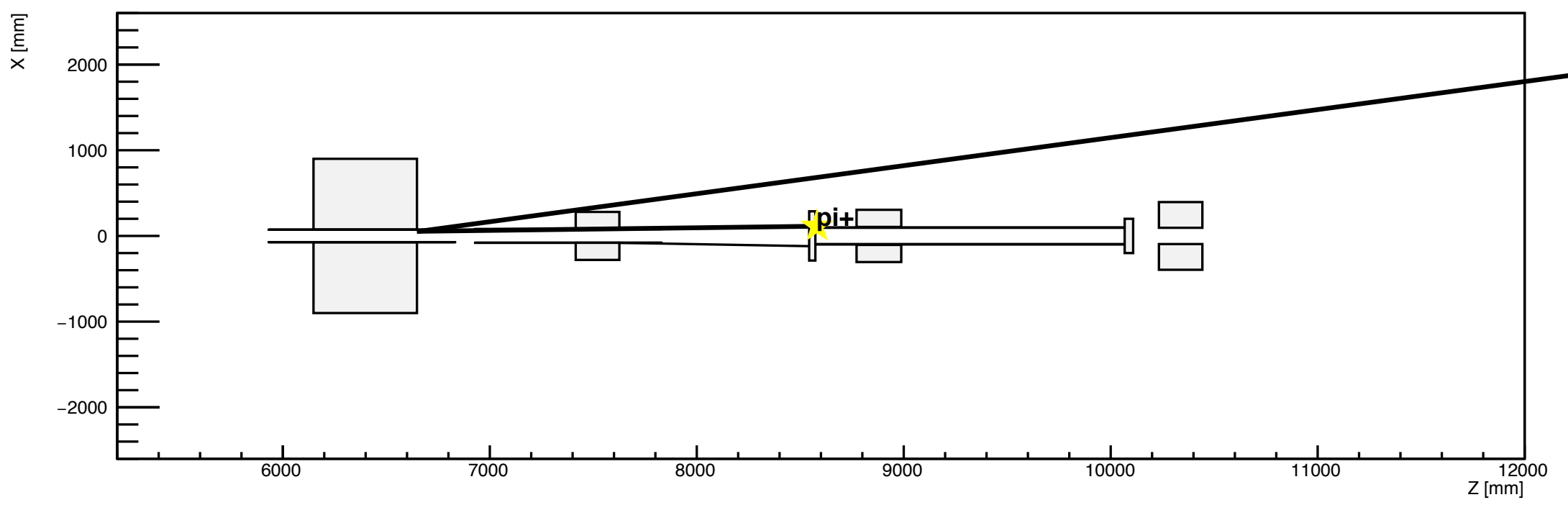

h1

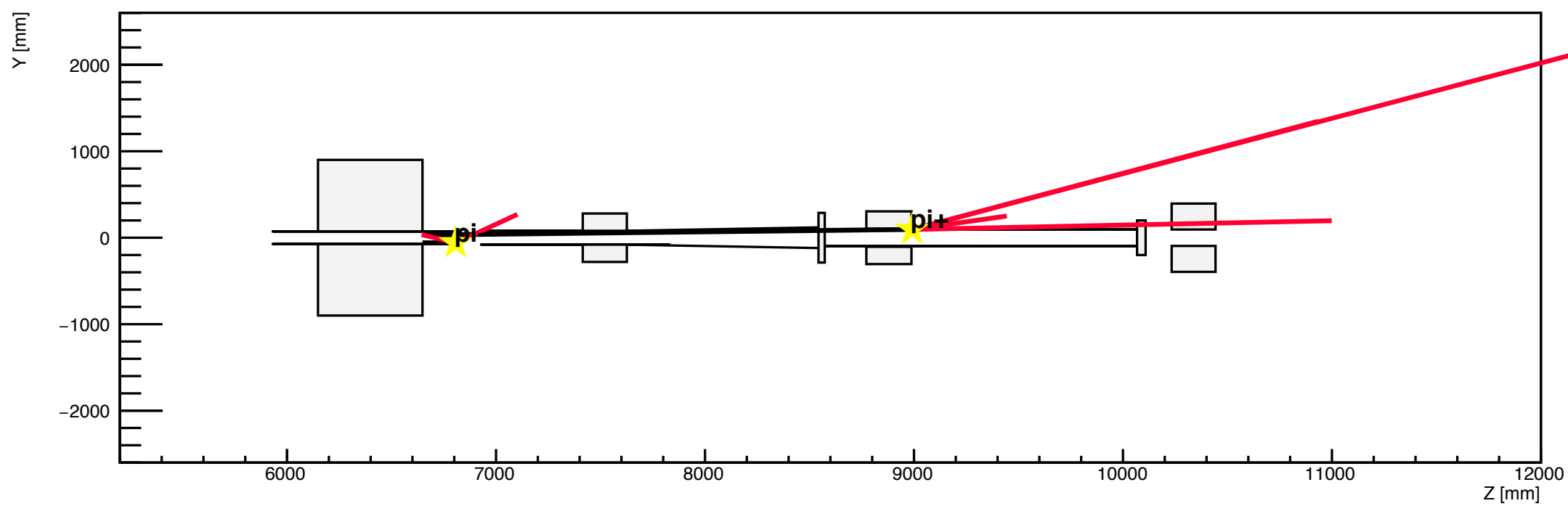

h2

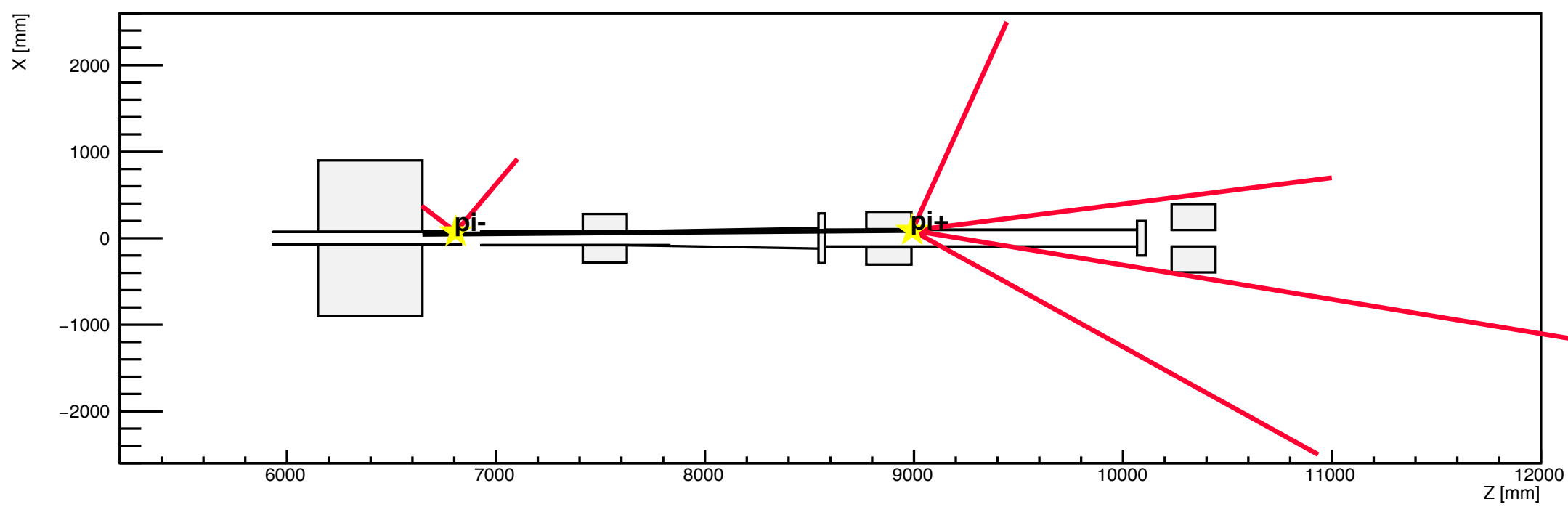

h1

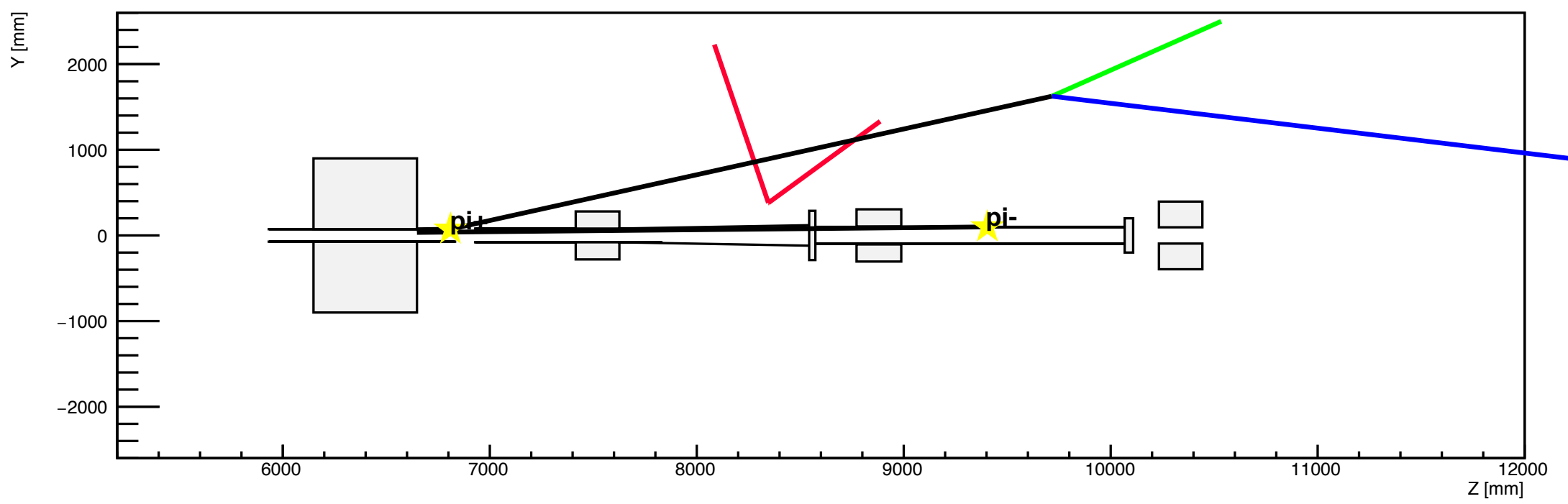

h2

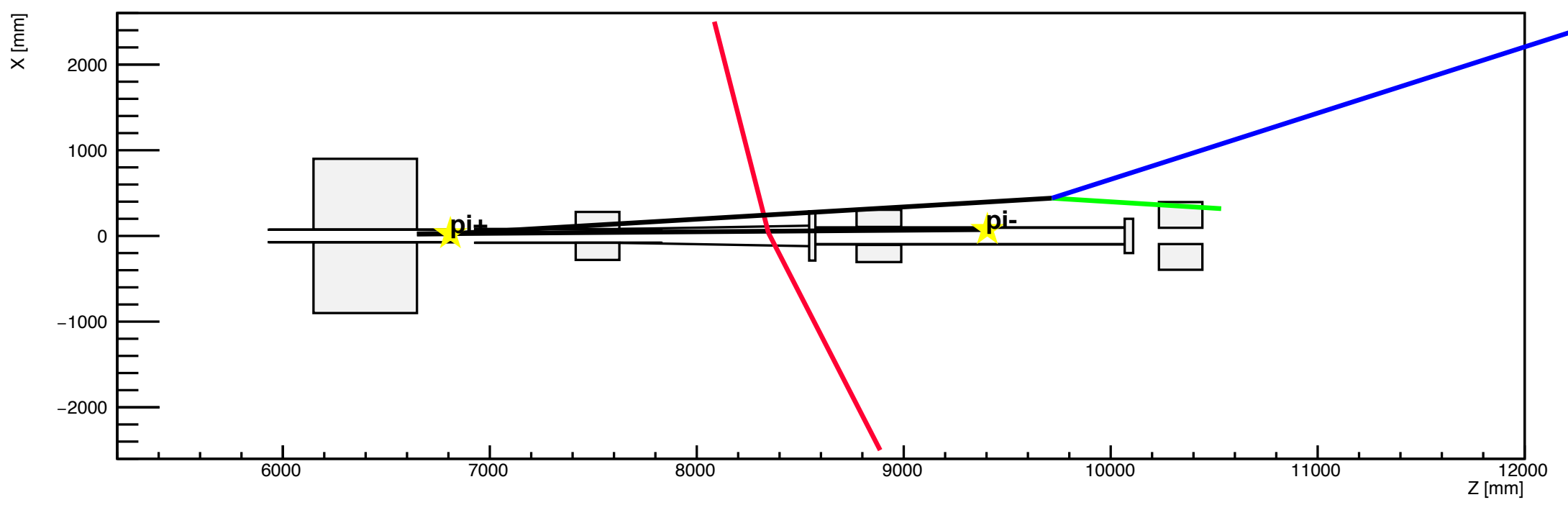

h1

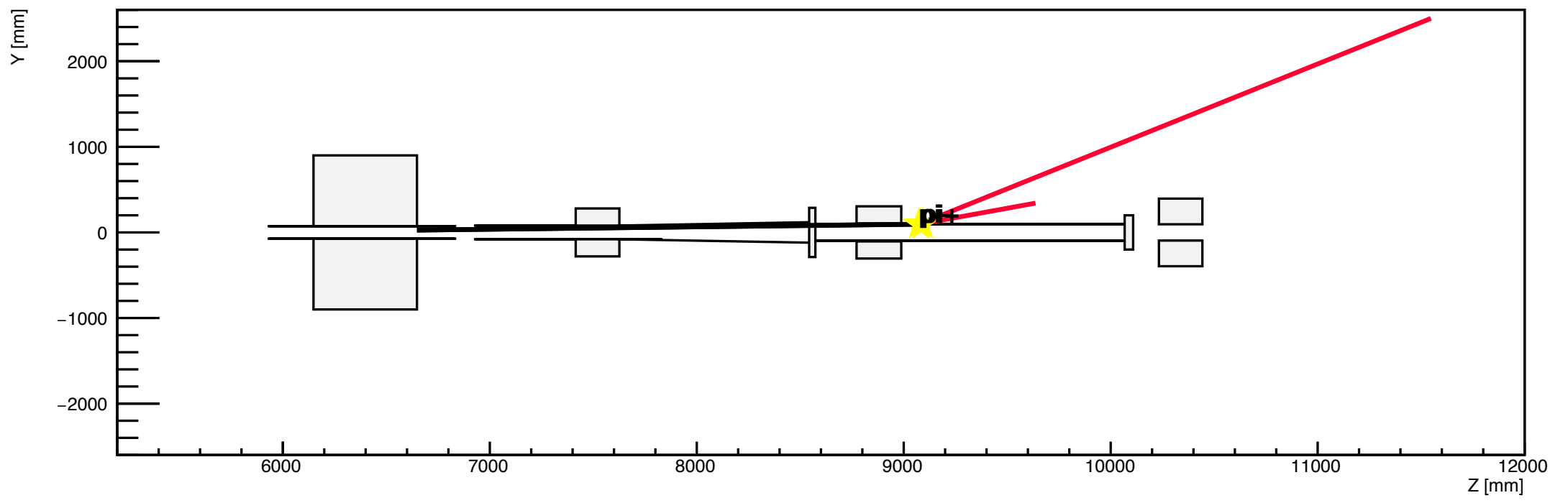

h2

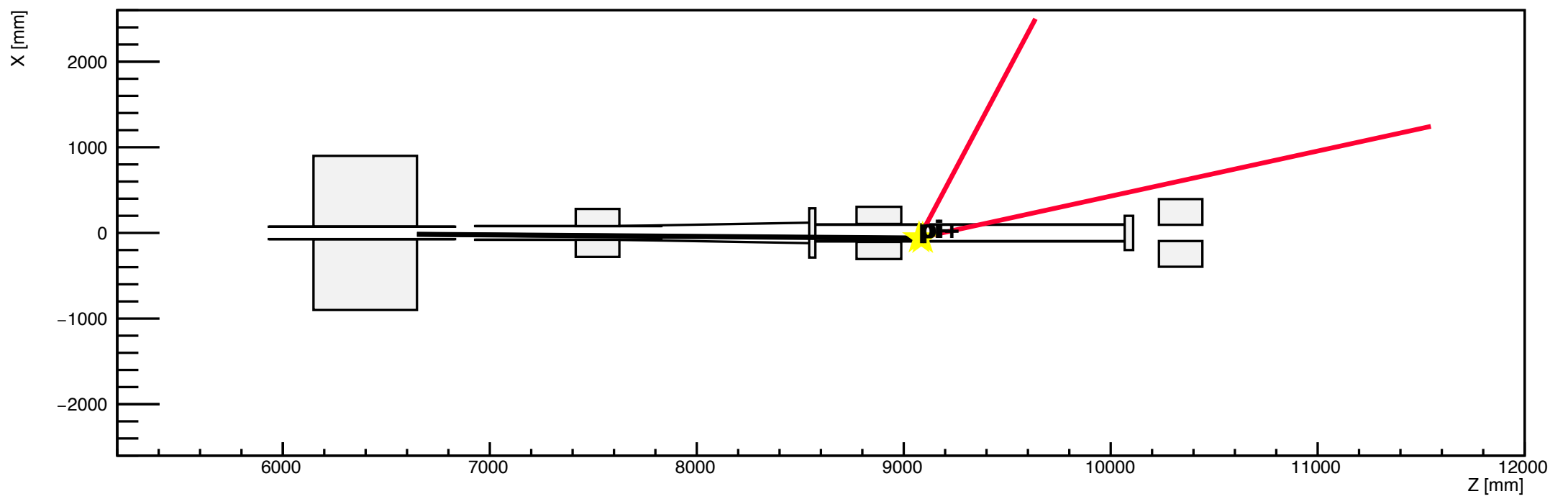

h1

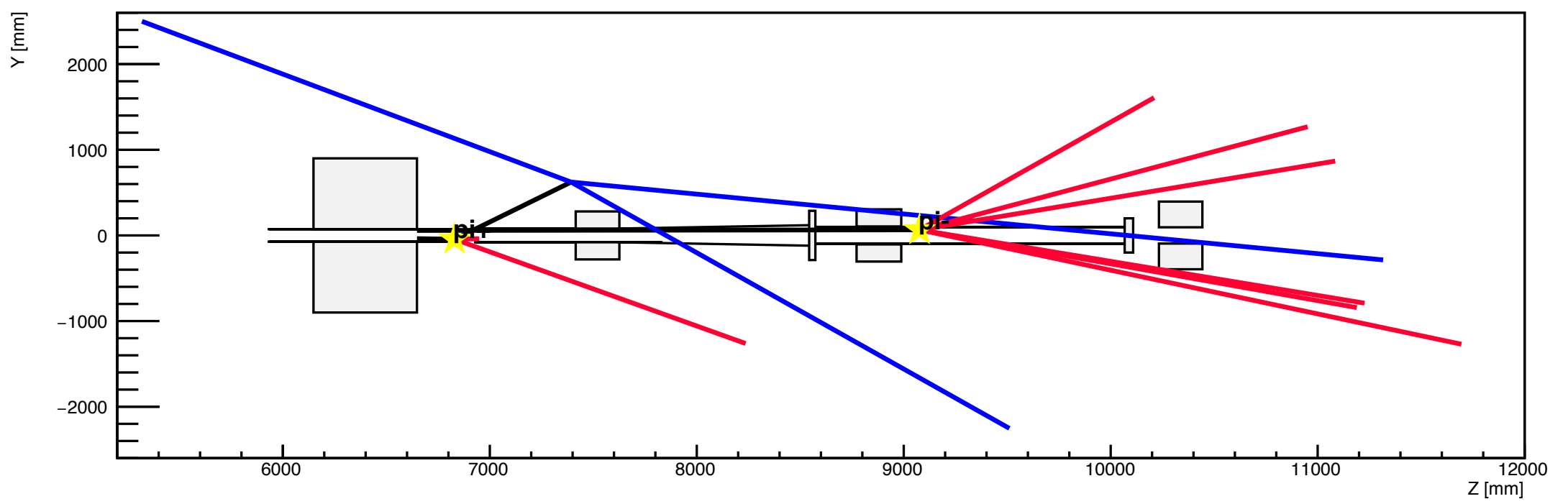

h2

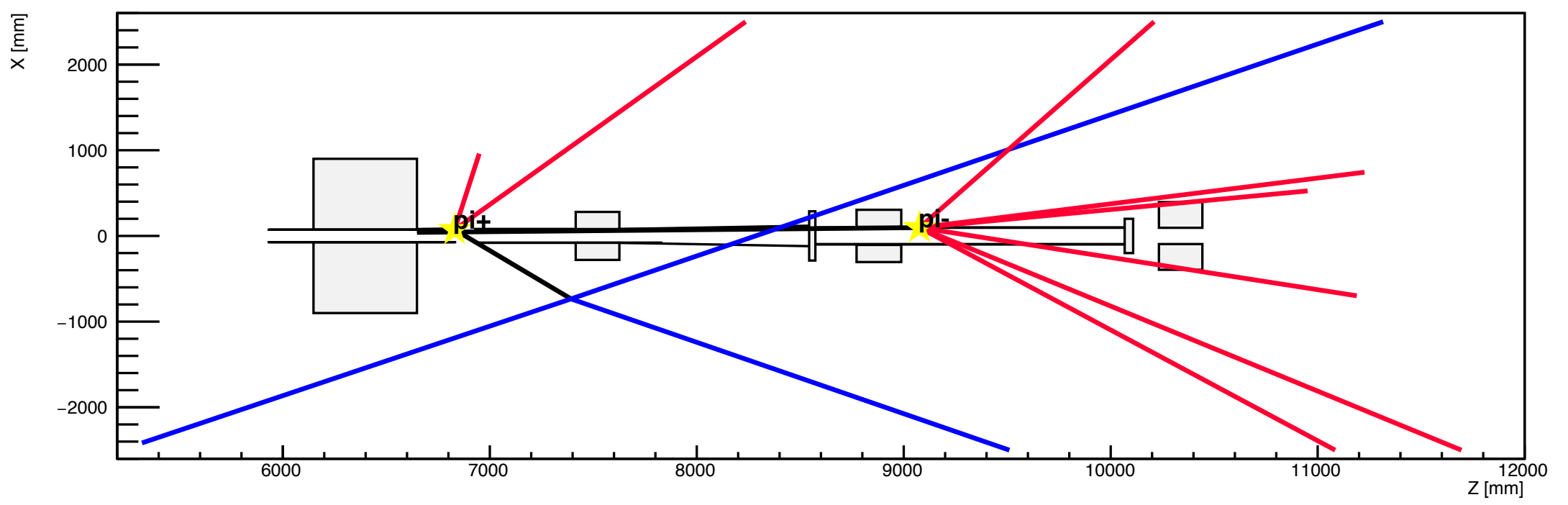

h1

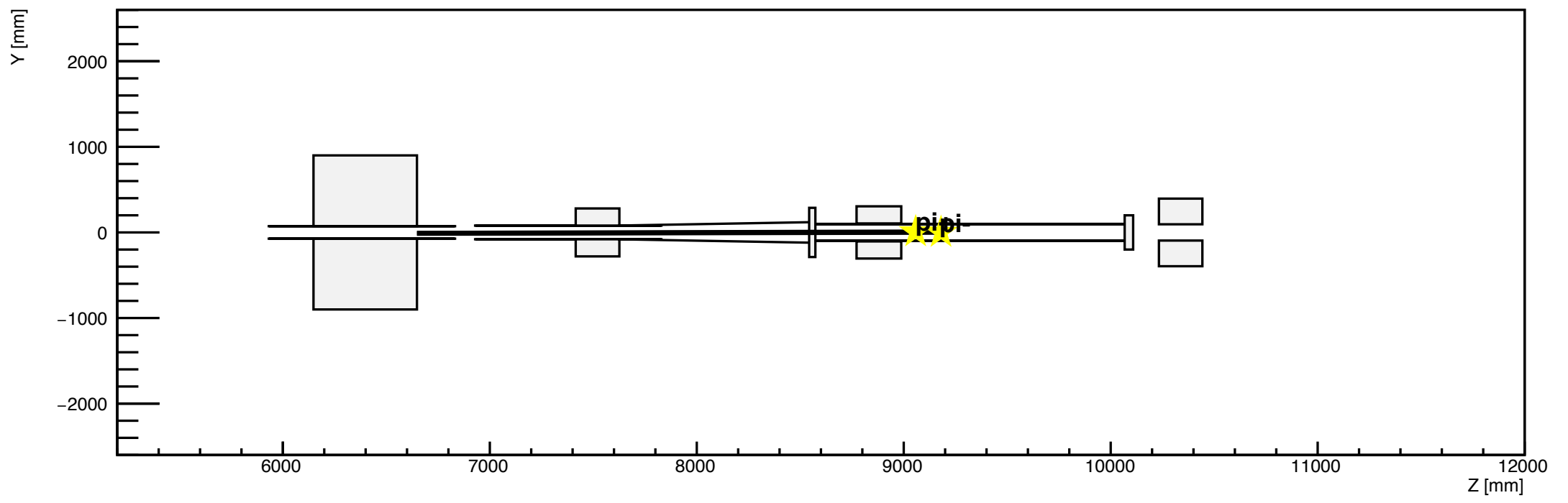

h2

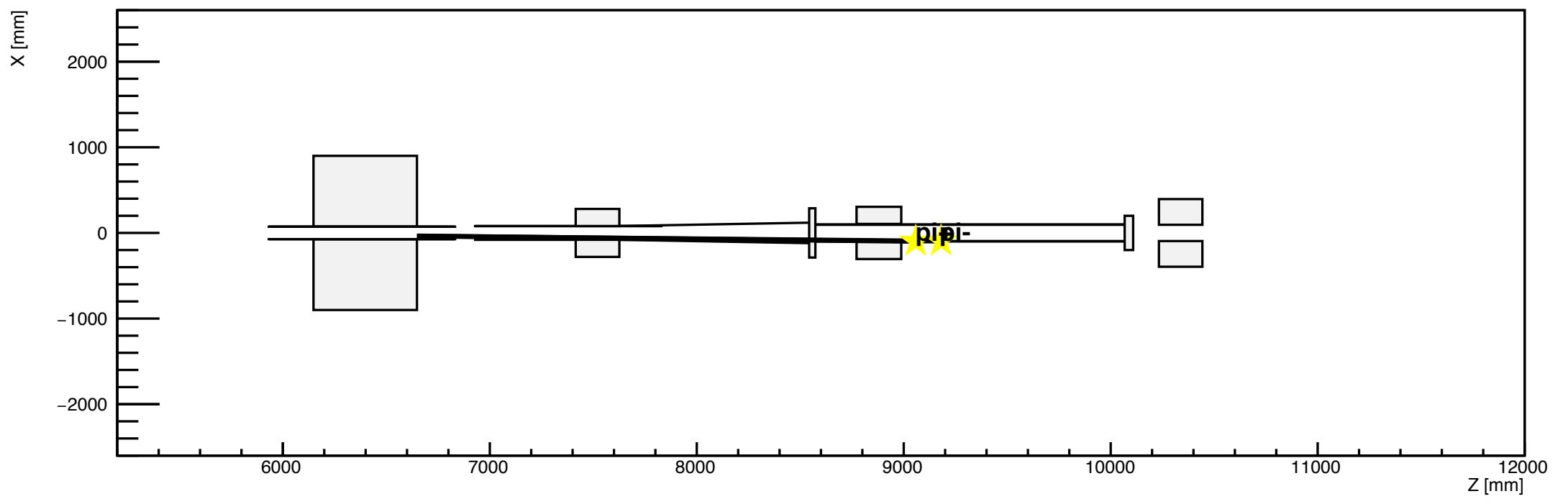

h1

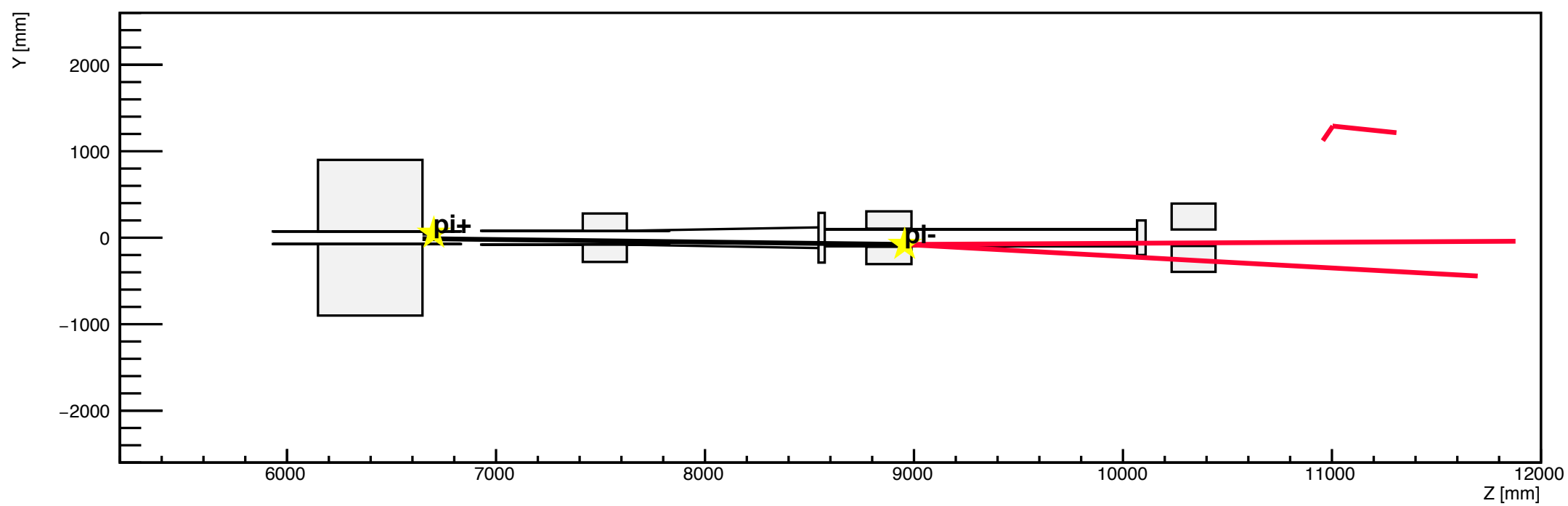

h2

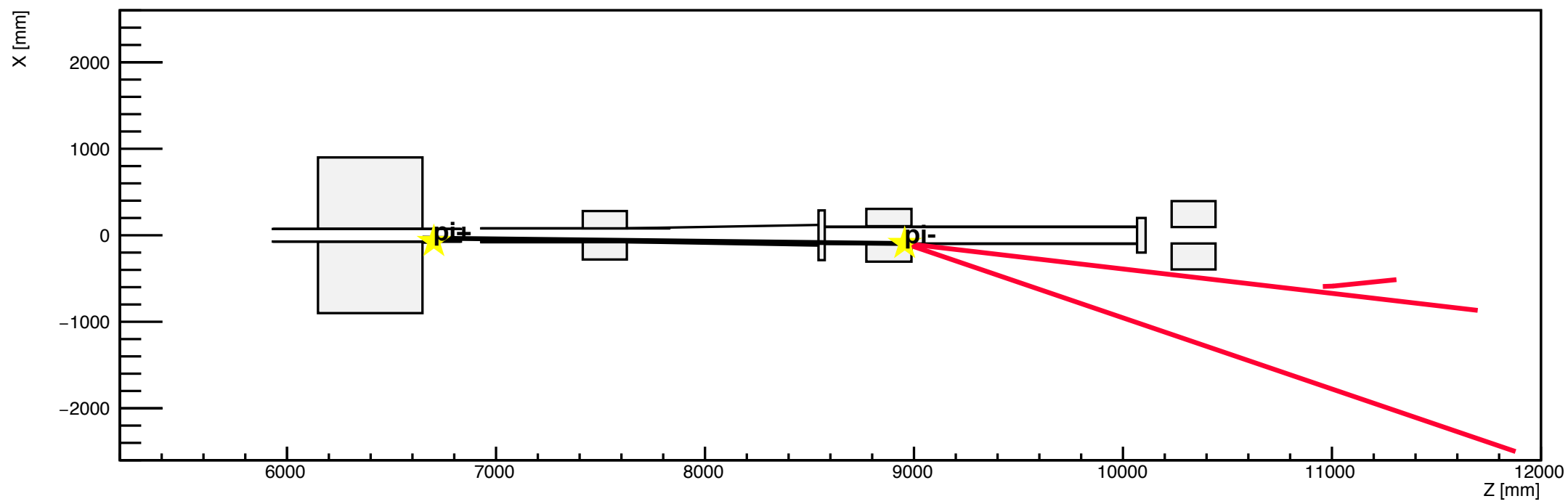

h1

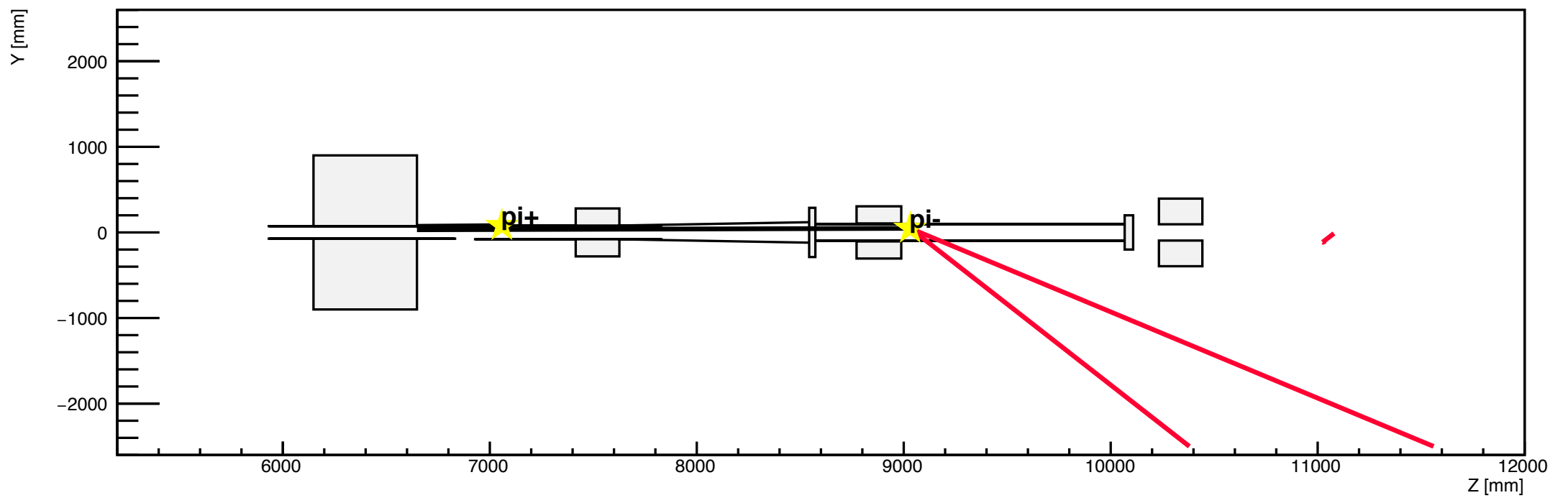

h2

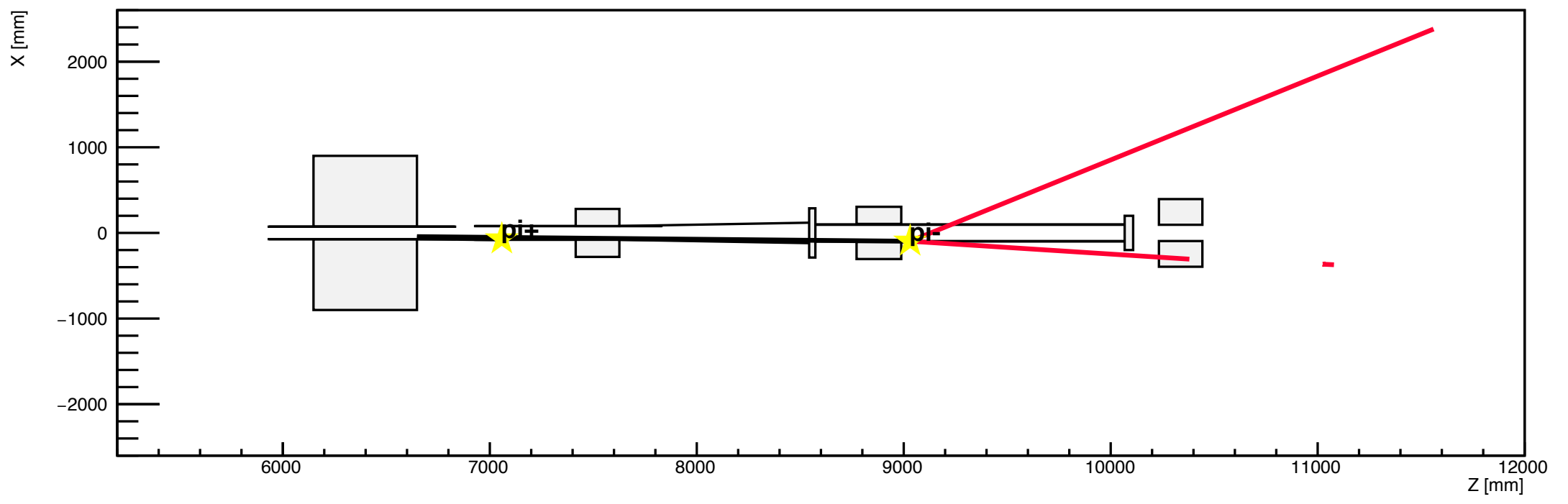

h1

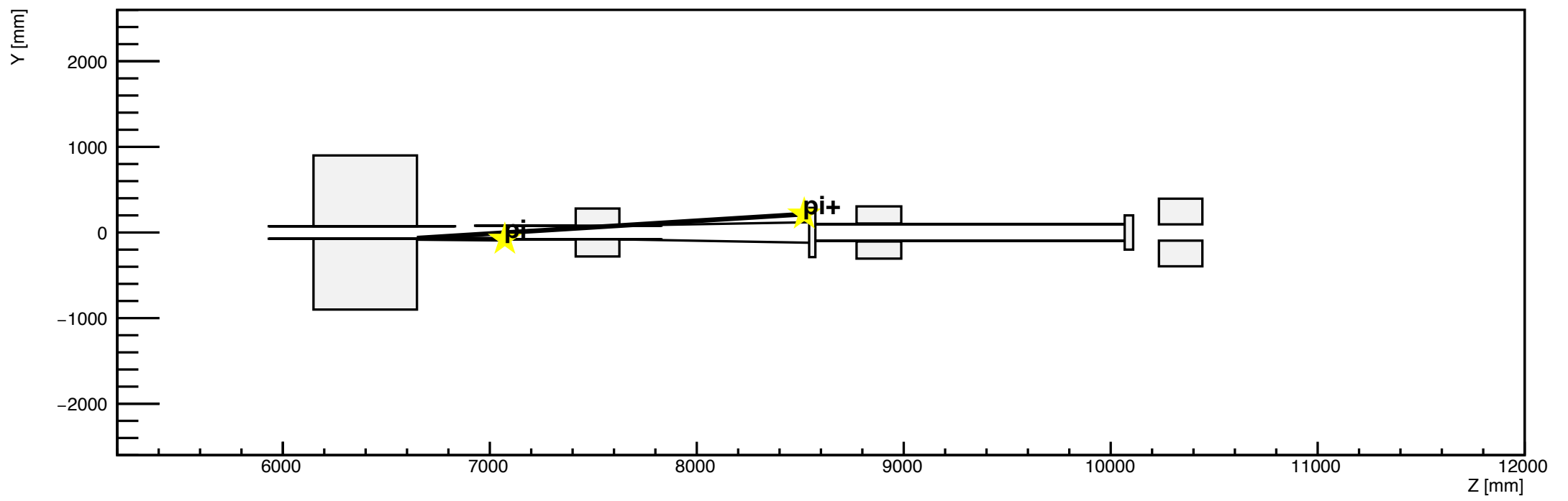

h2

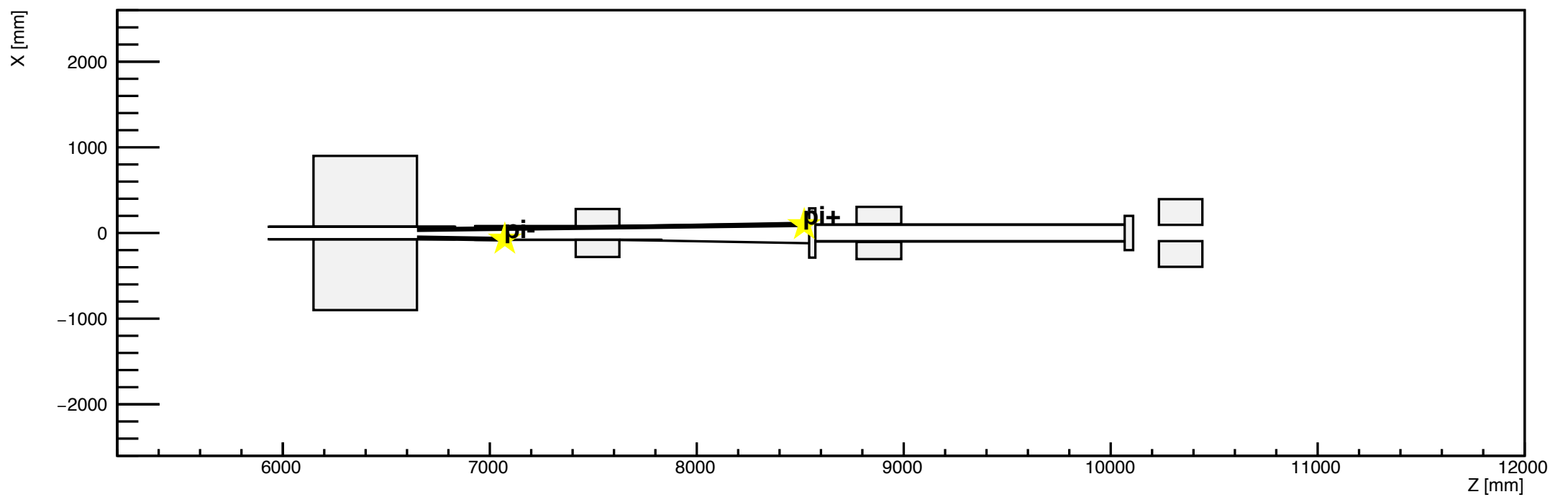

h1

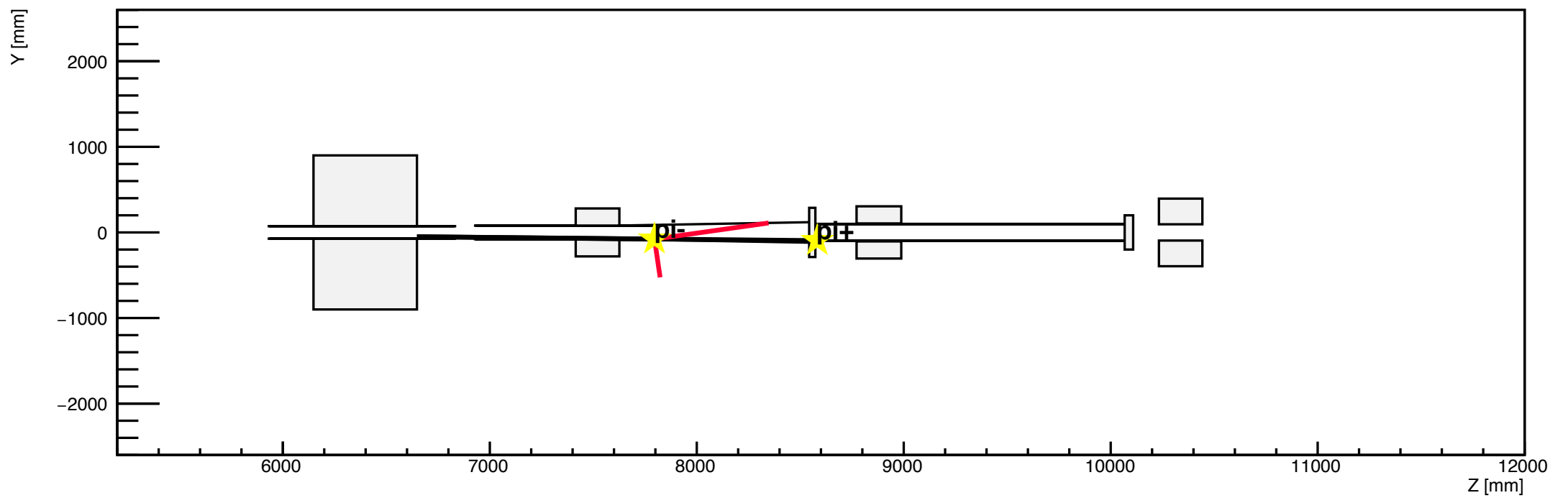

h2

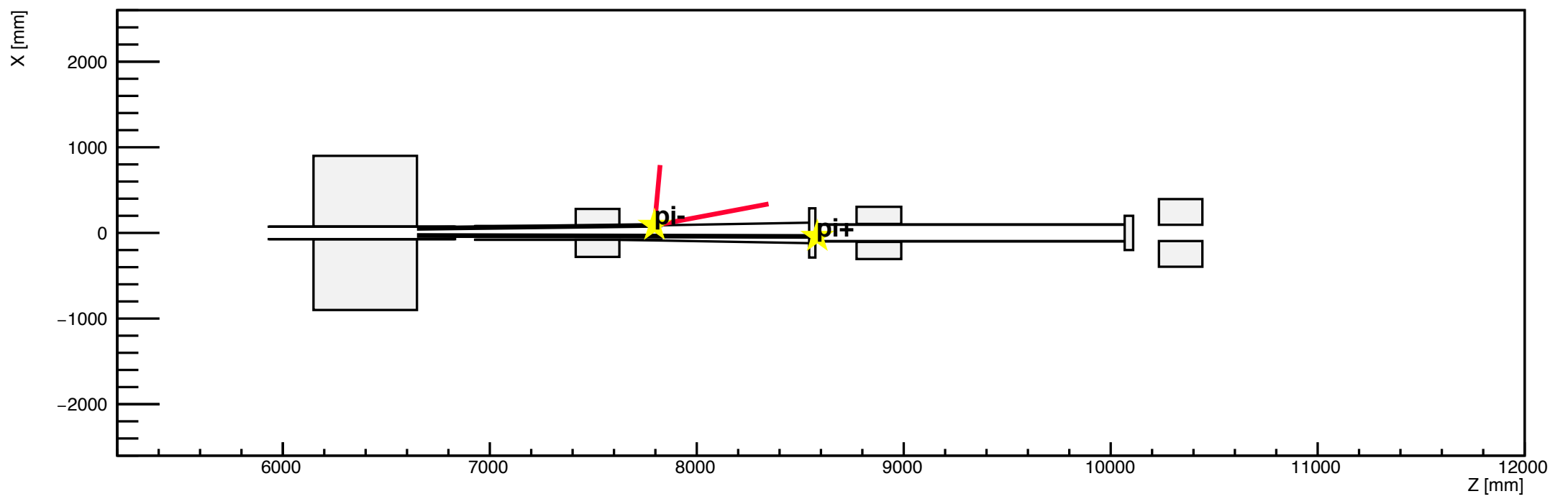

h1

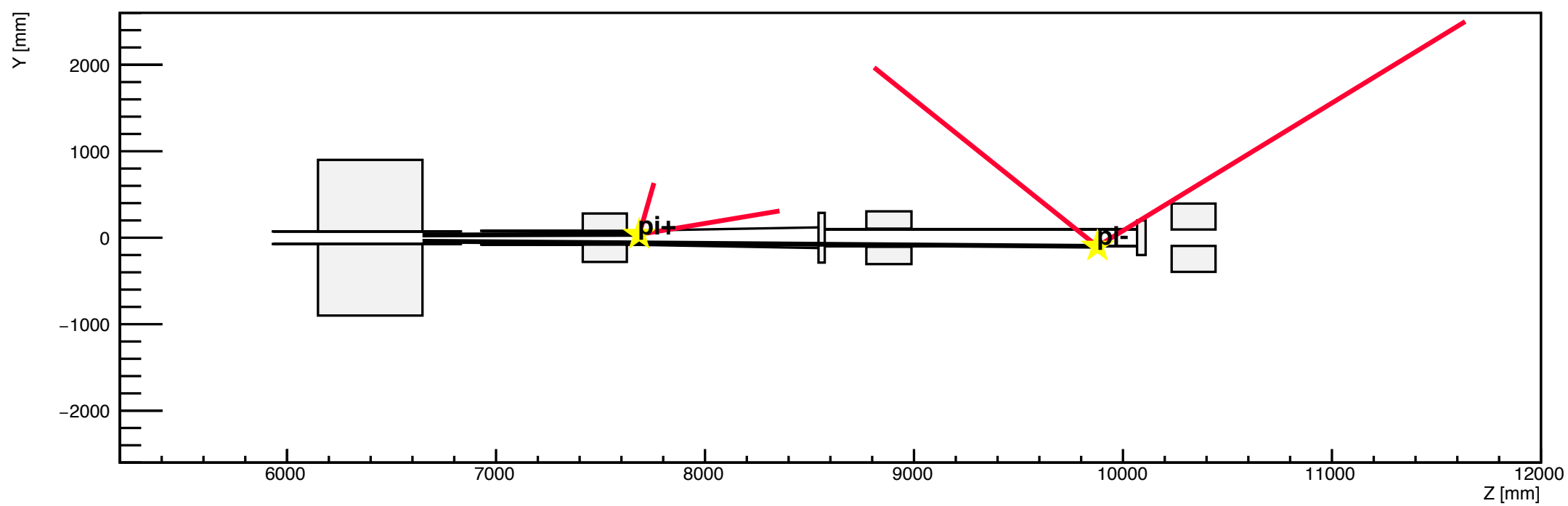

h2

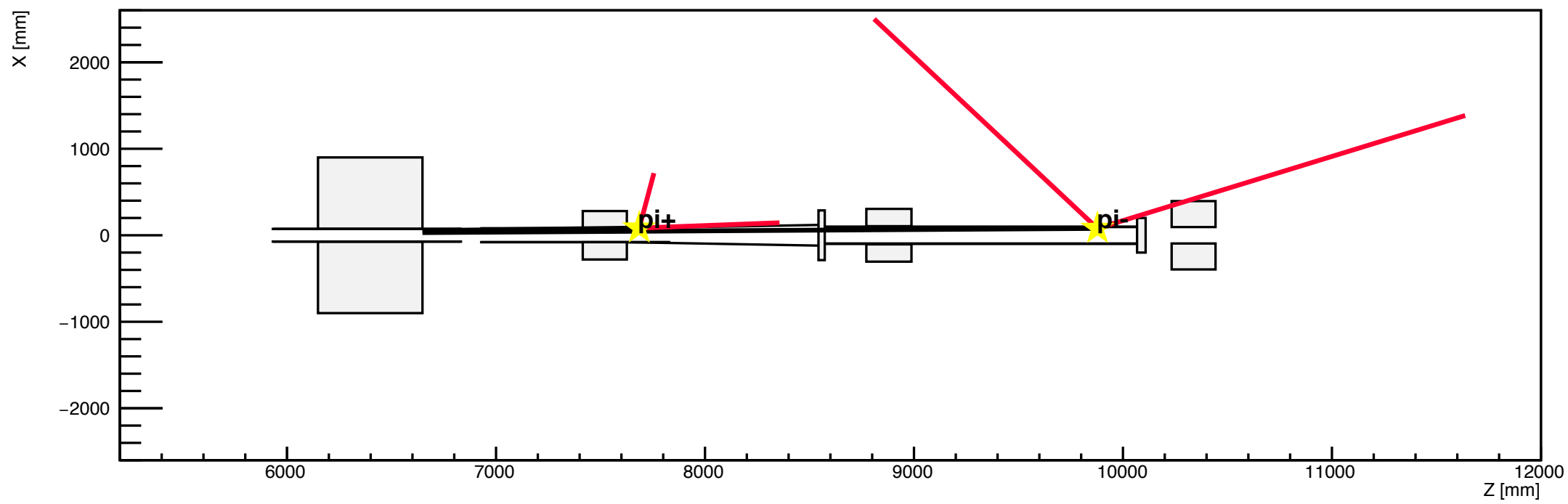

h1

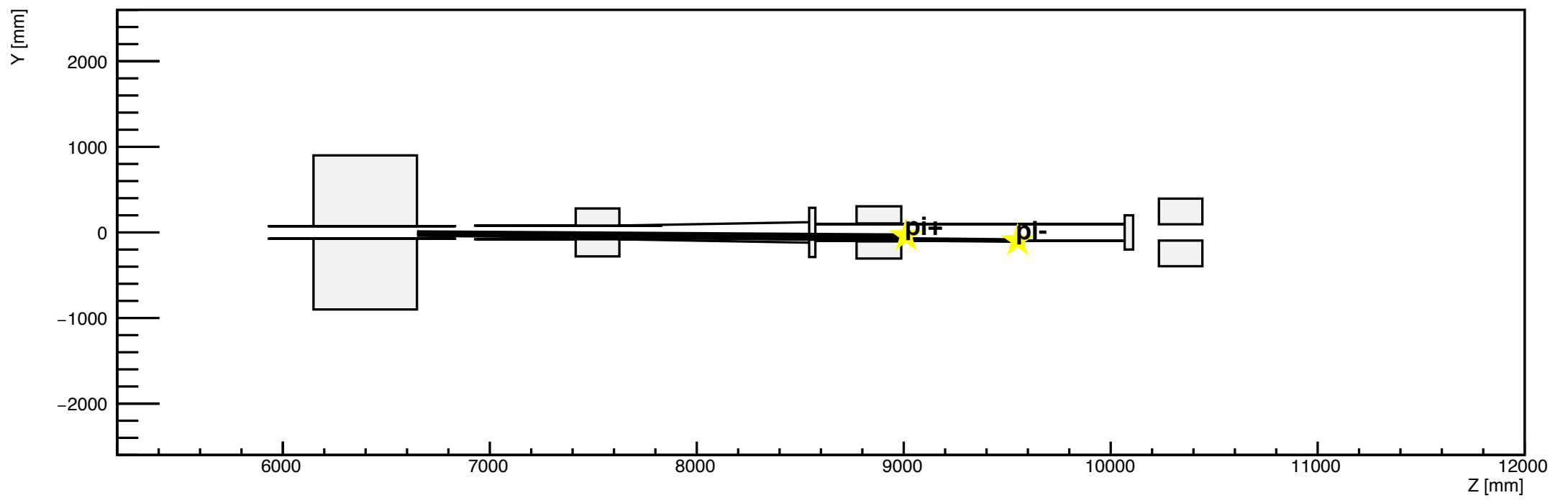

h2

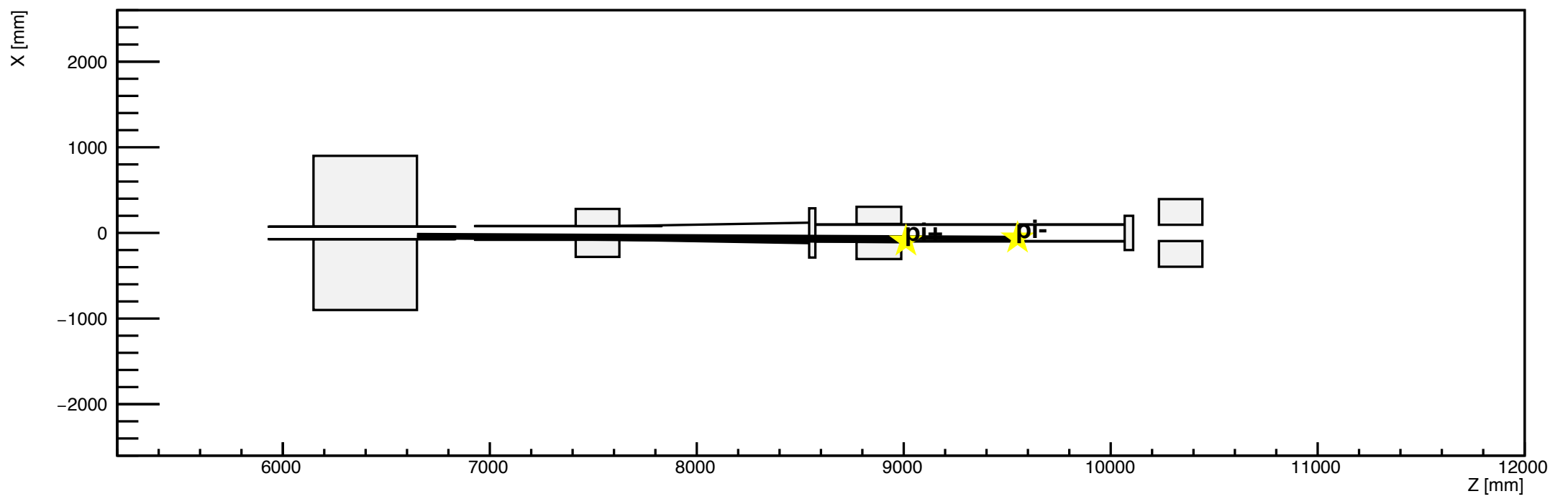

h1

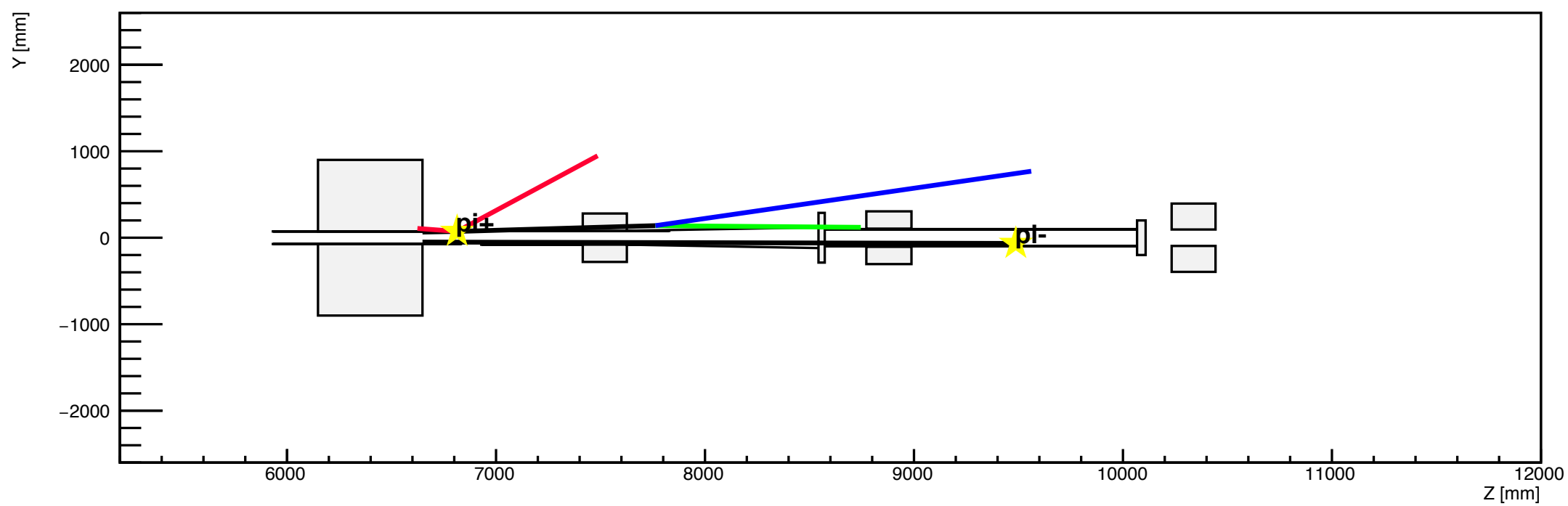

h2

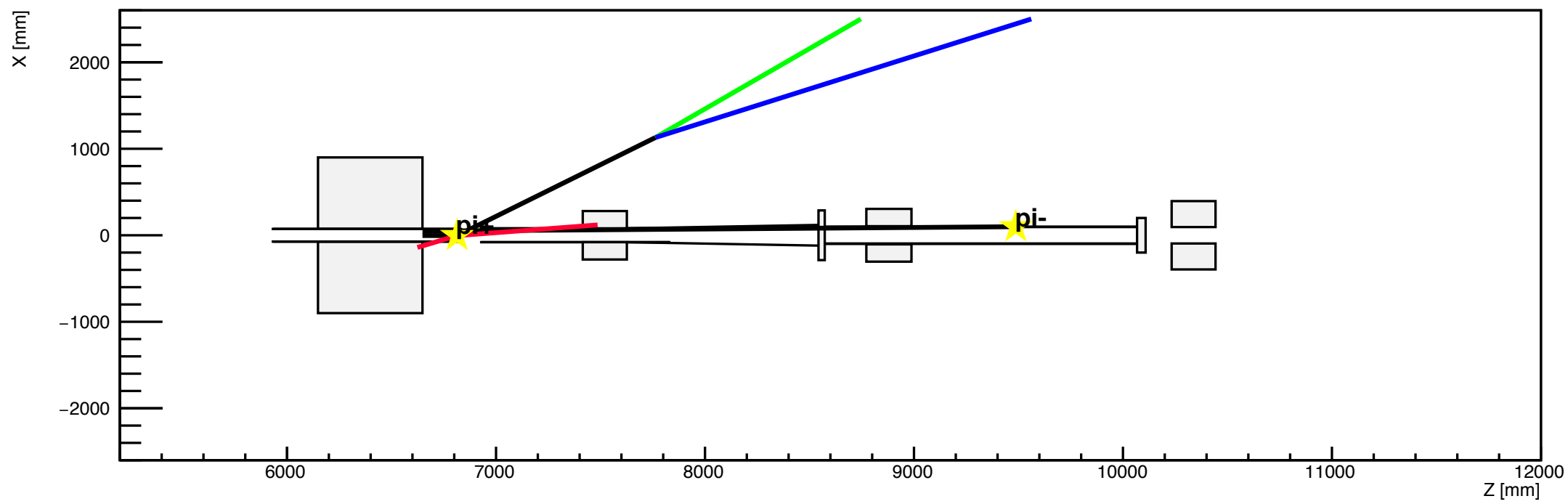

h1

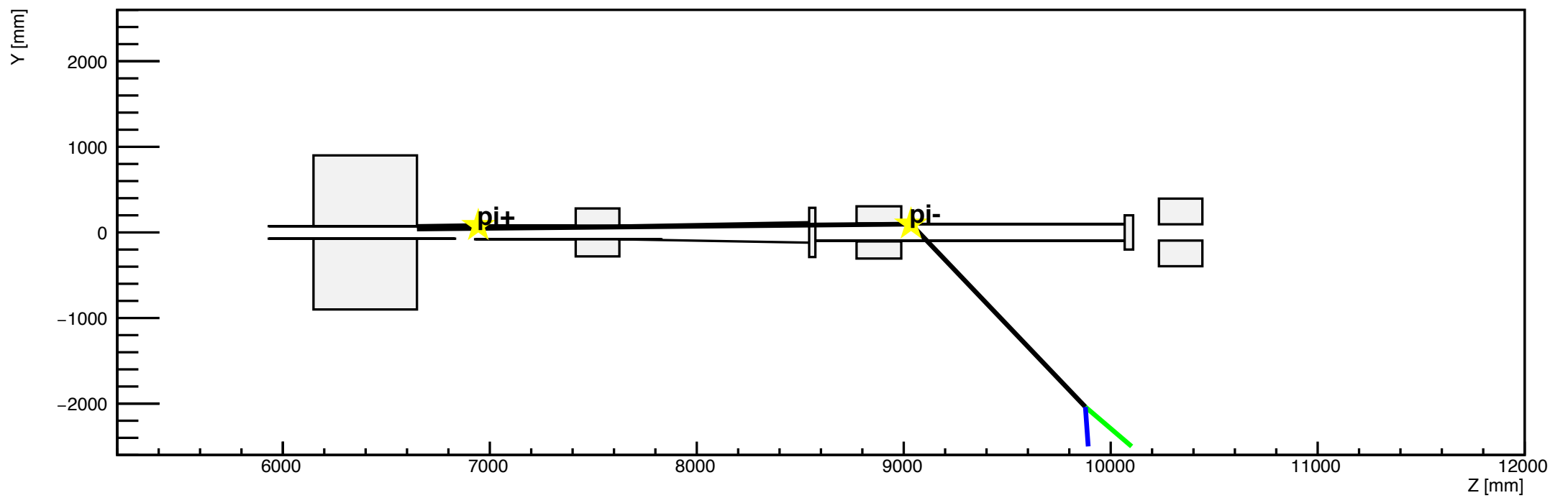

h2

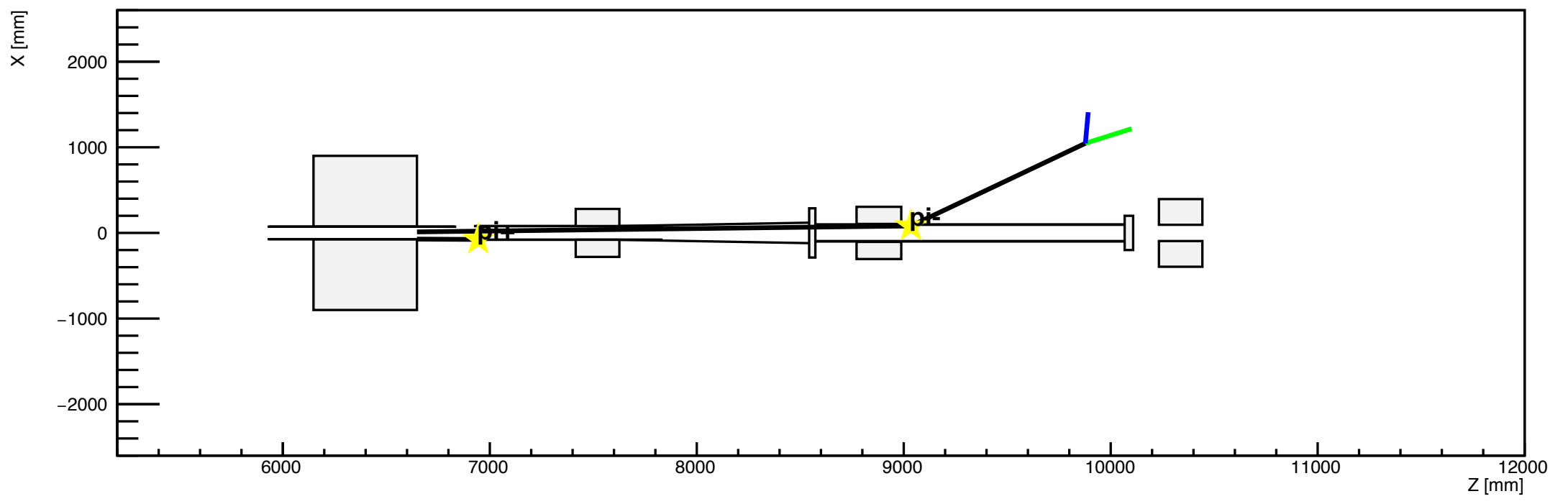

h1

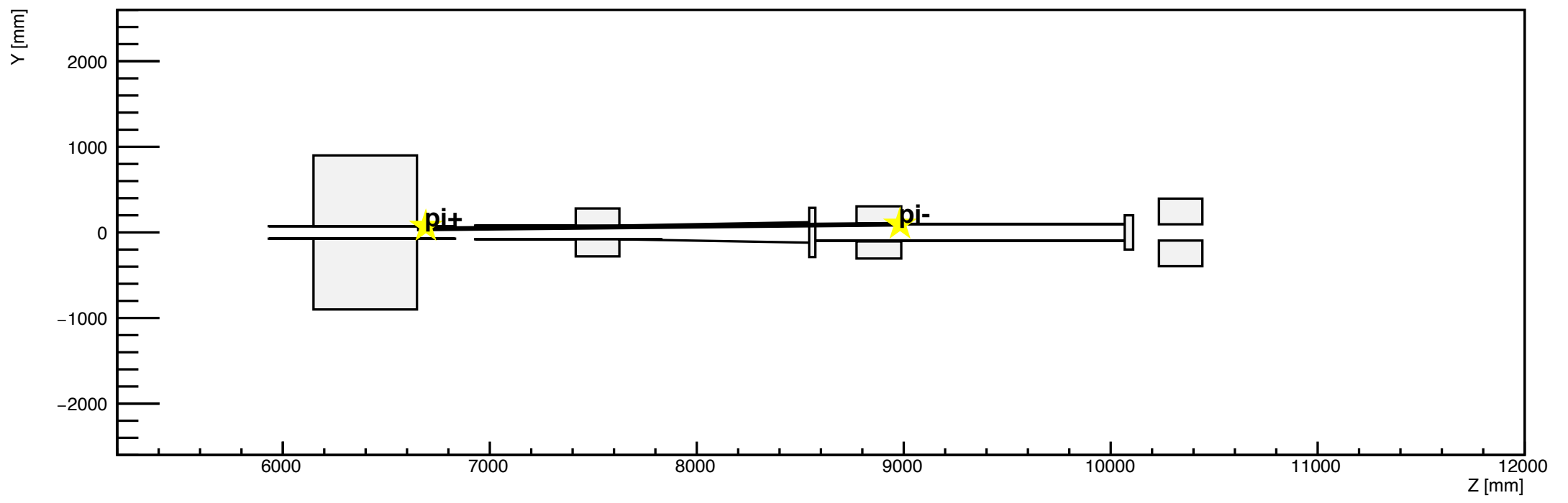

h2

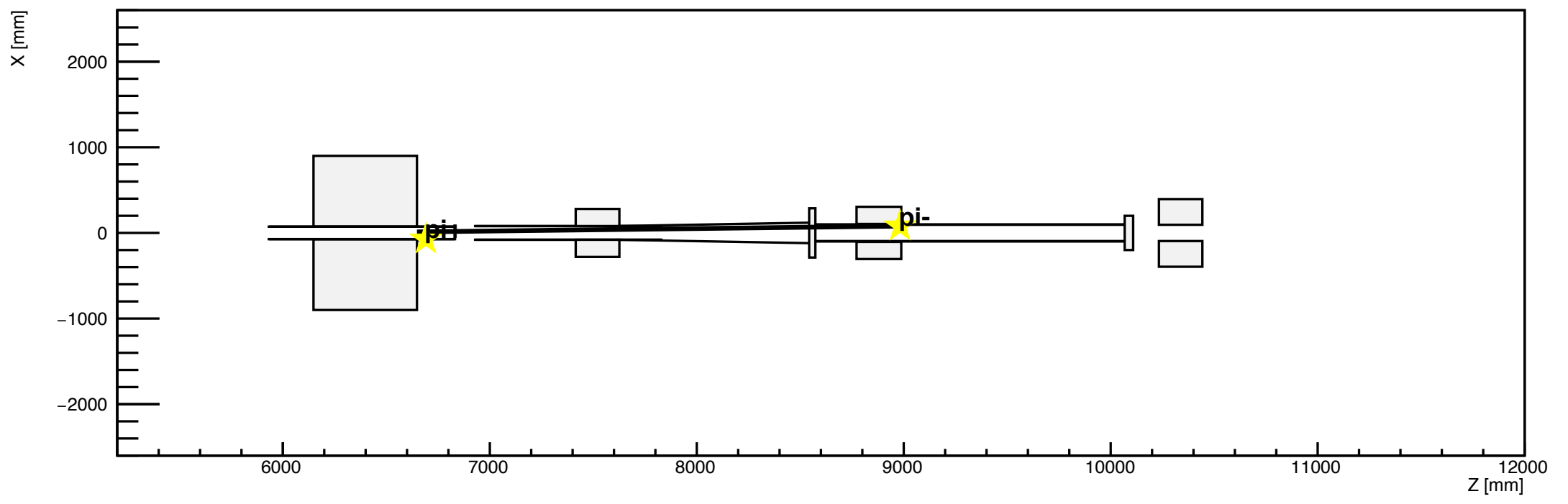

h1

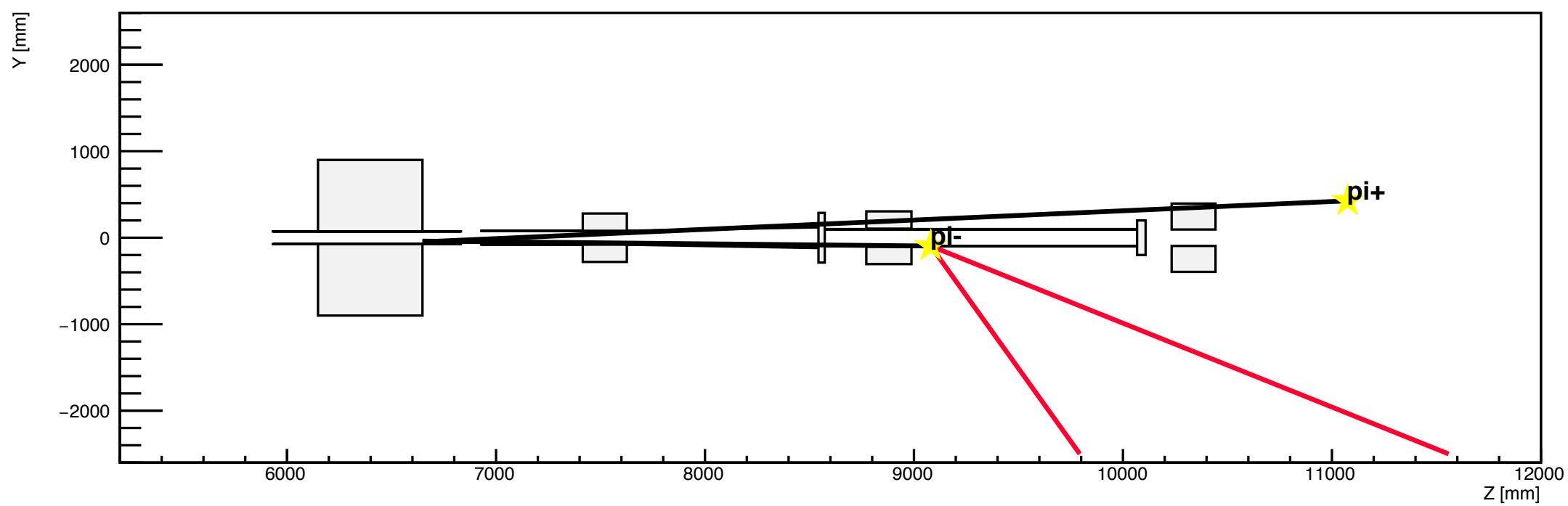

h2

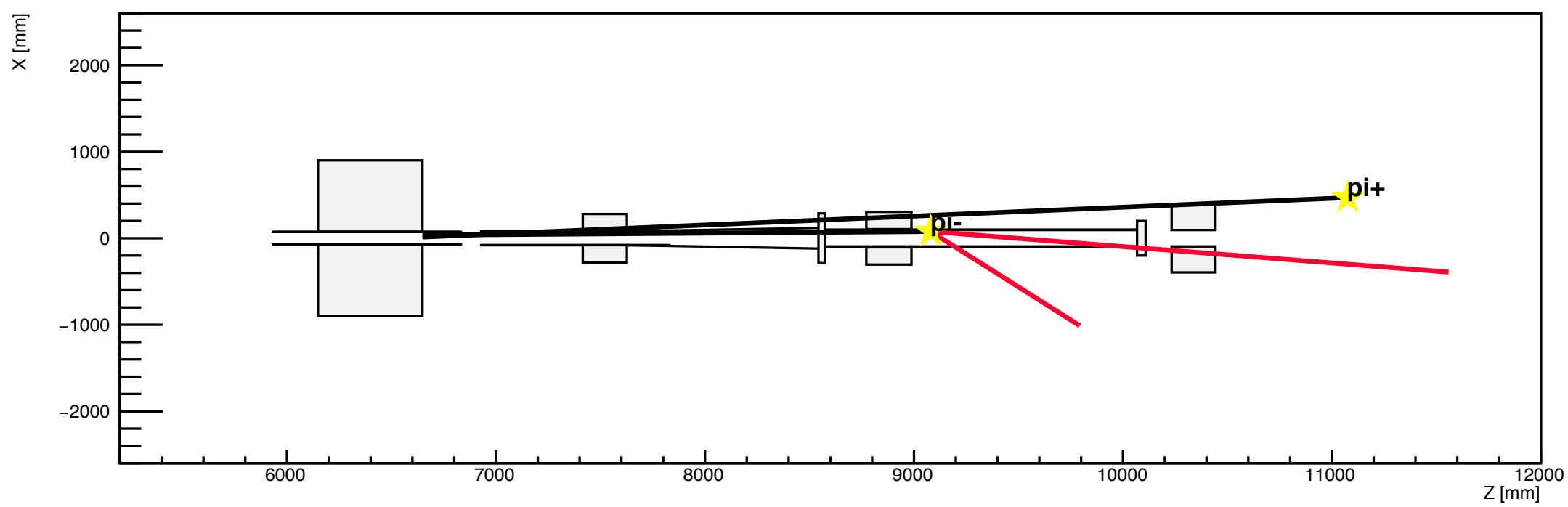

h1

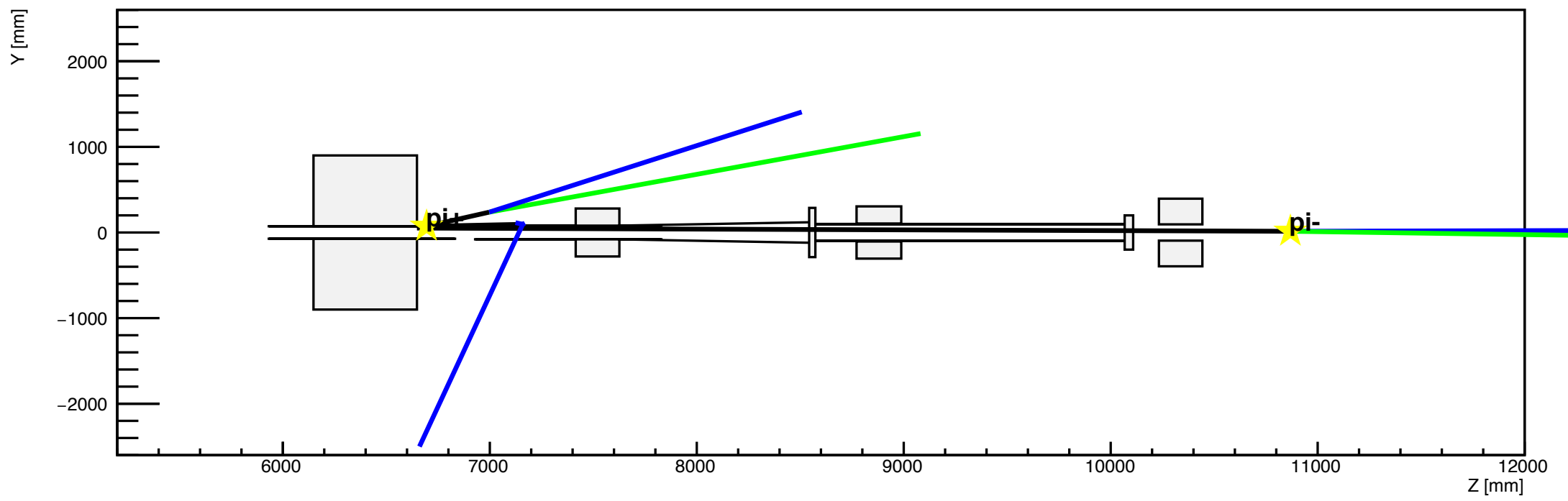

h2

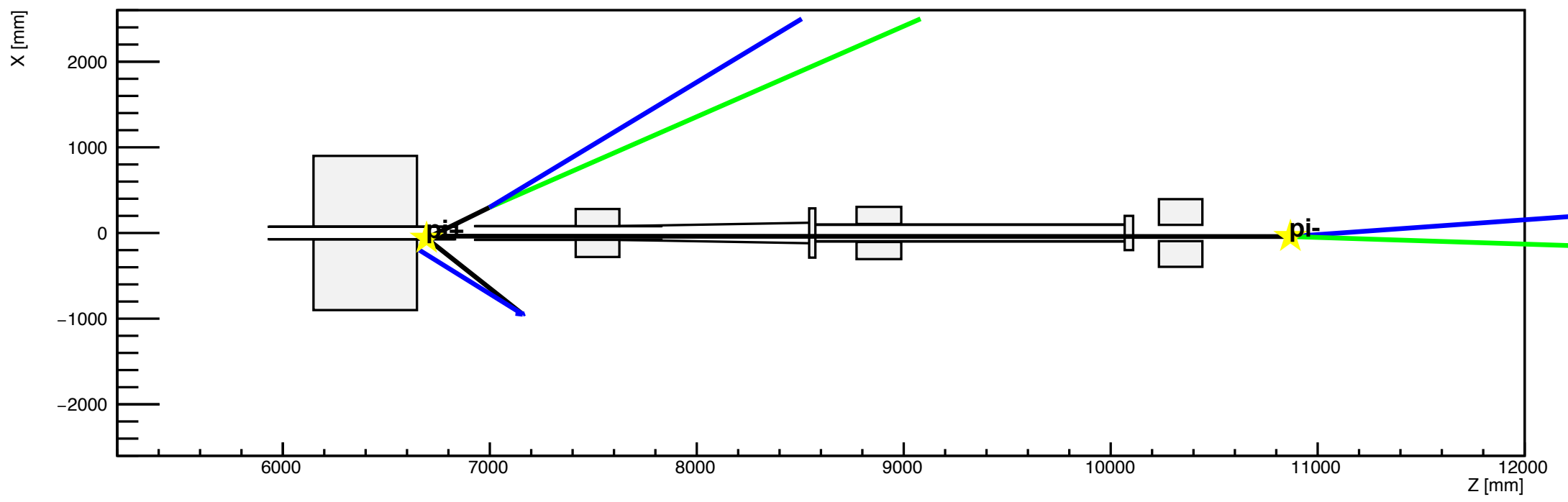

h1

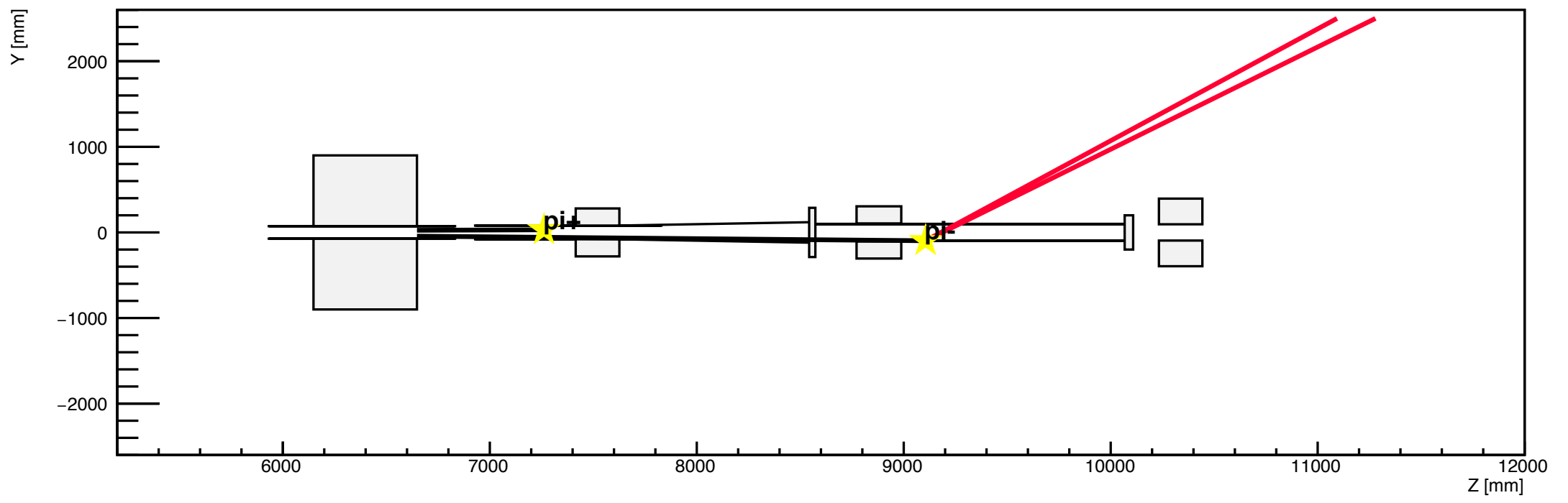

h2

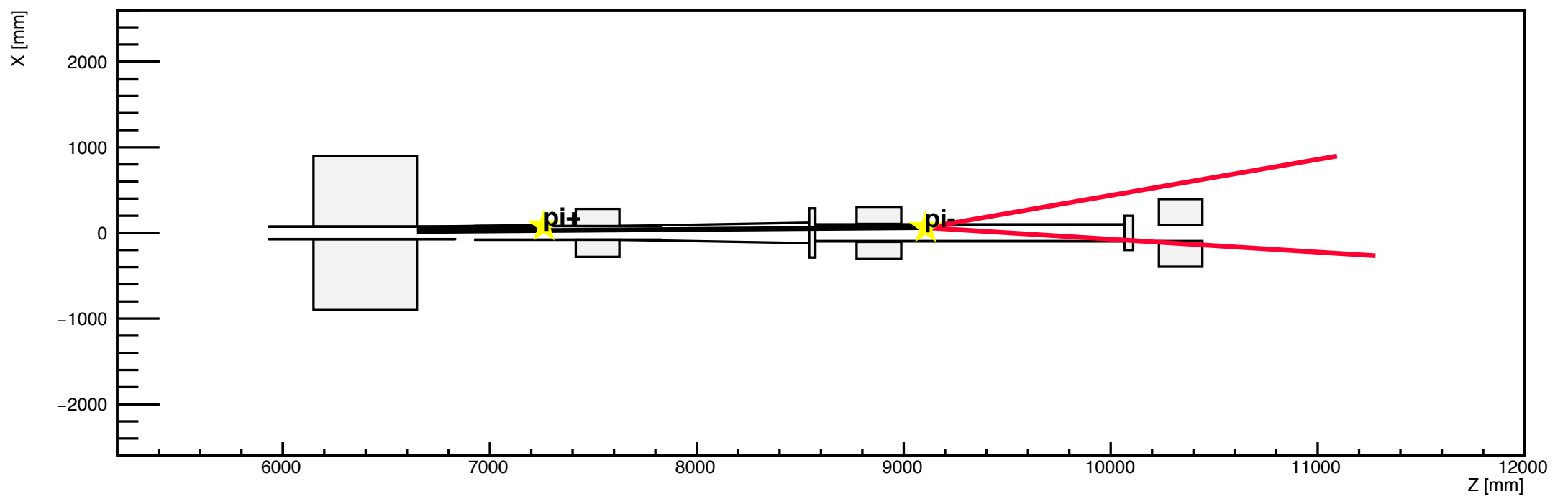

h1

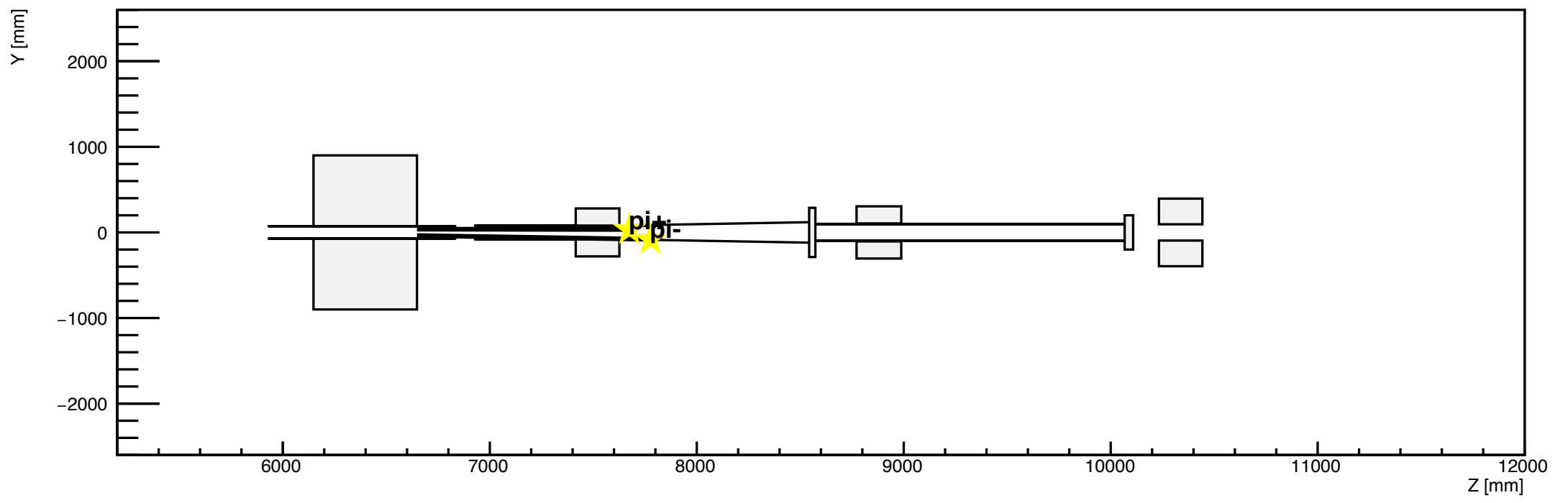

h2

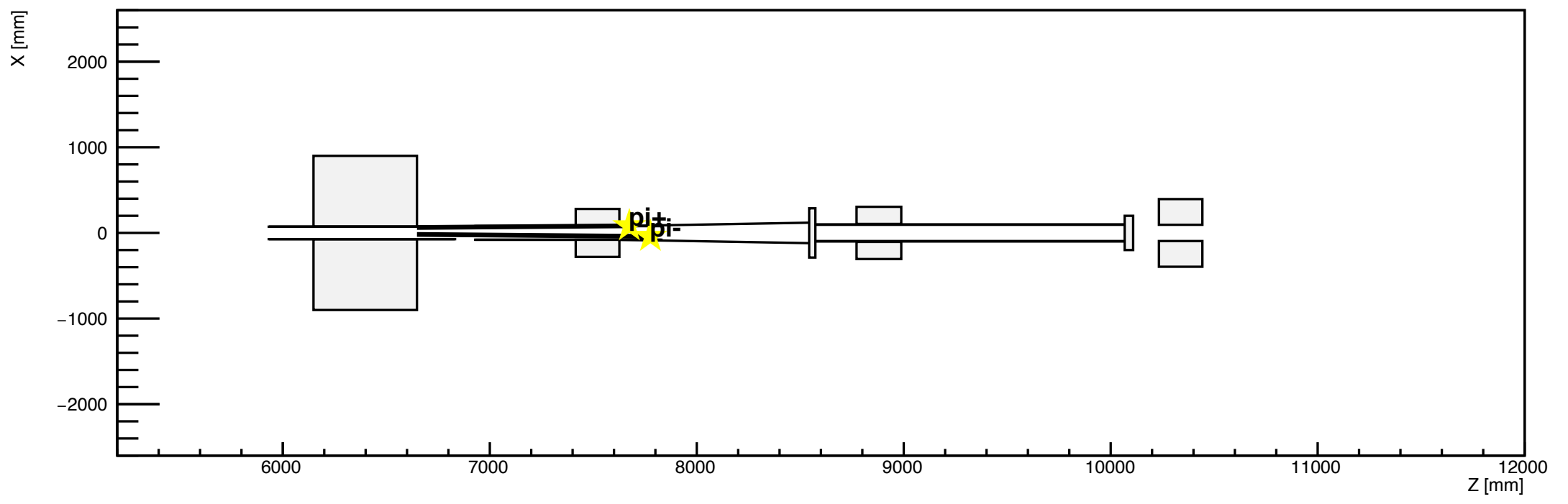

h1

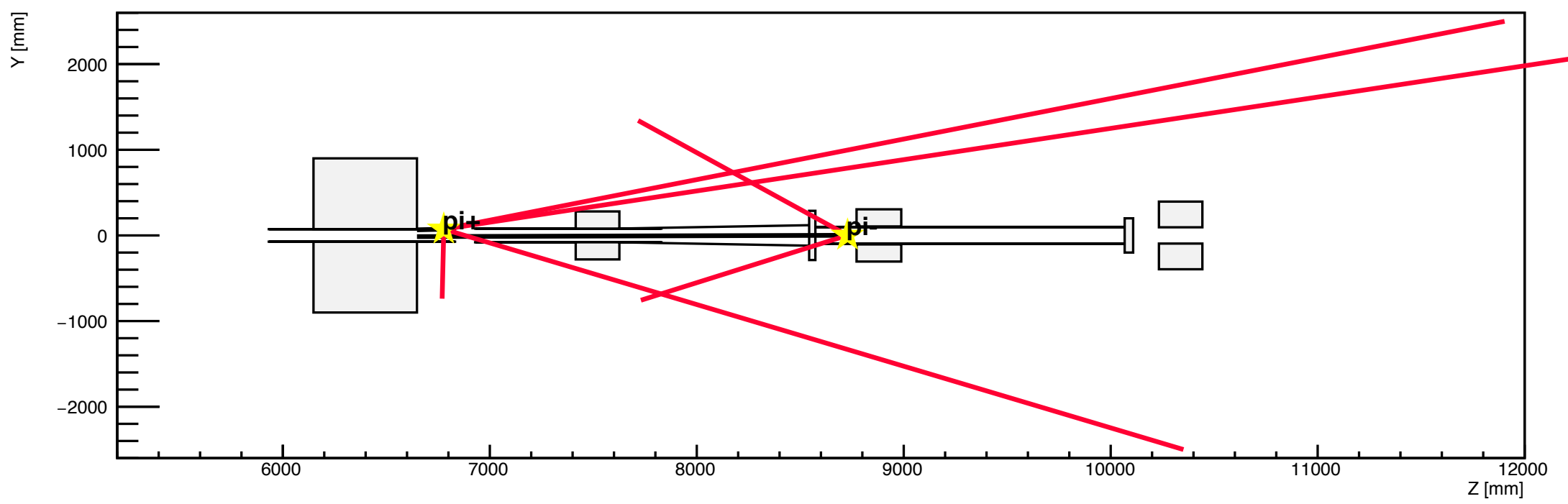

h2

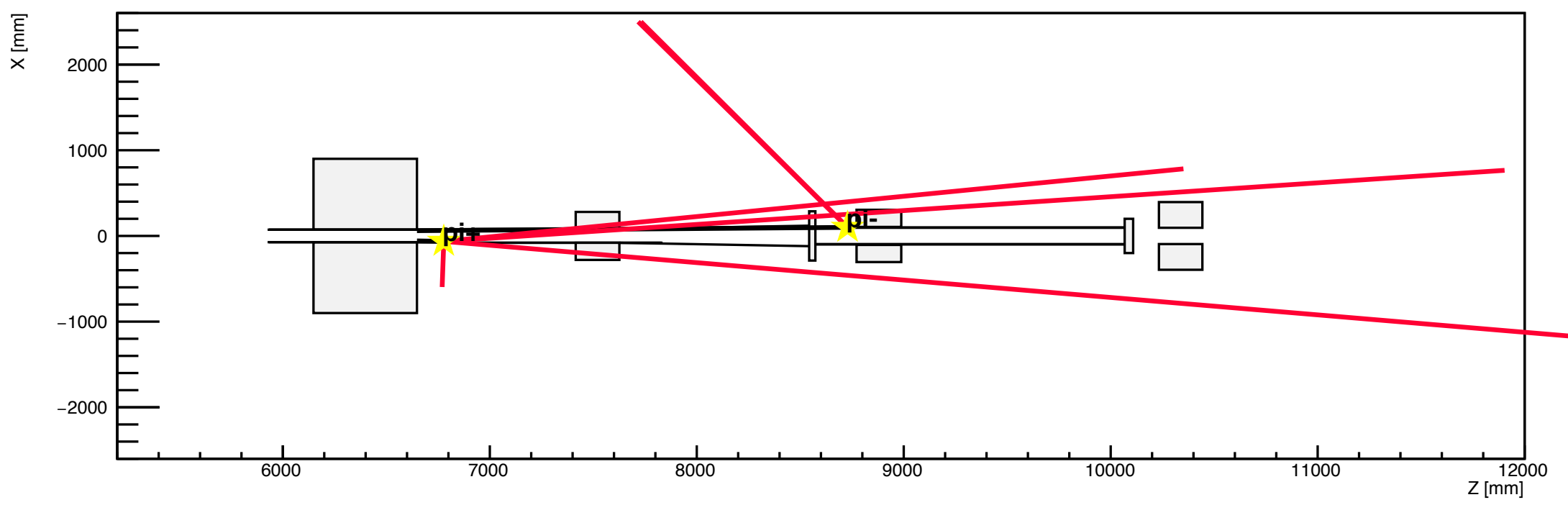

h1

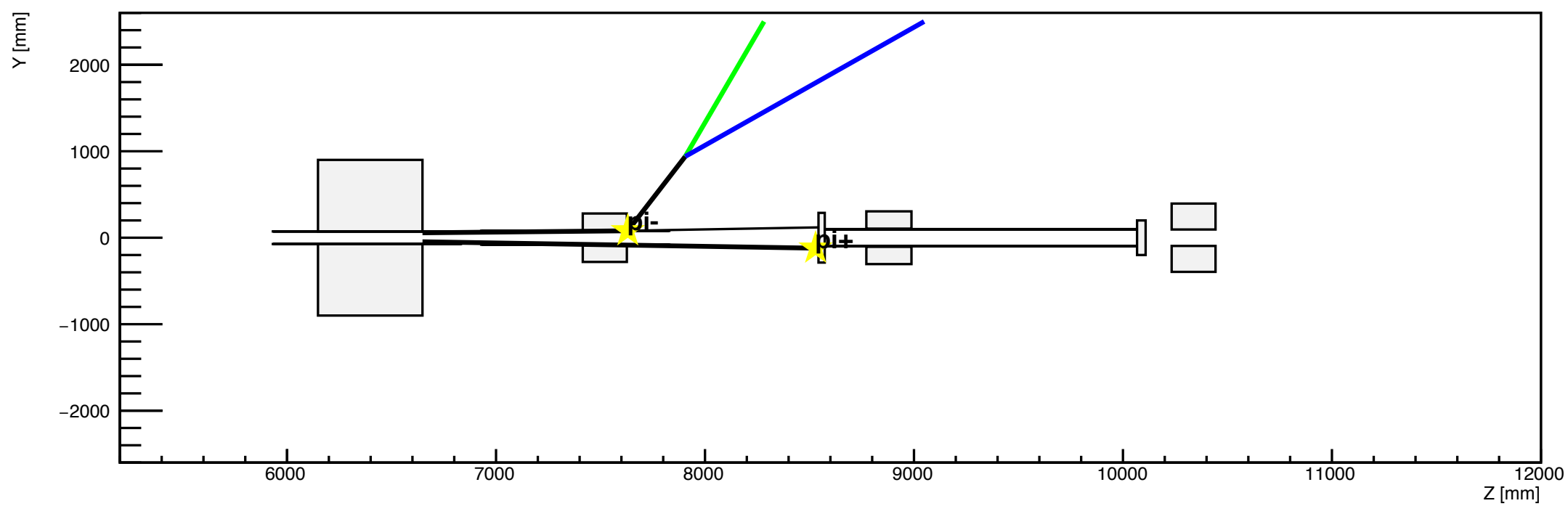

h2

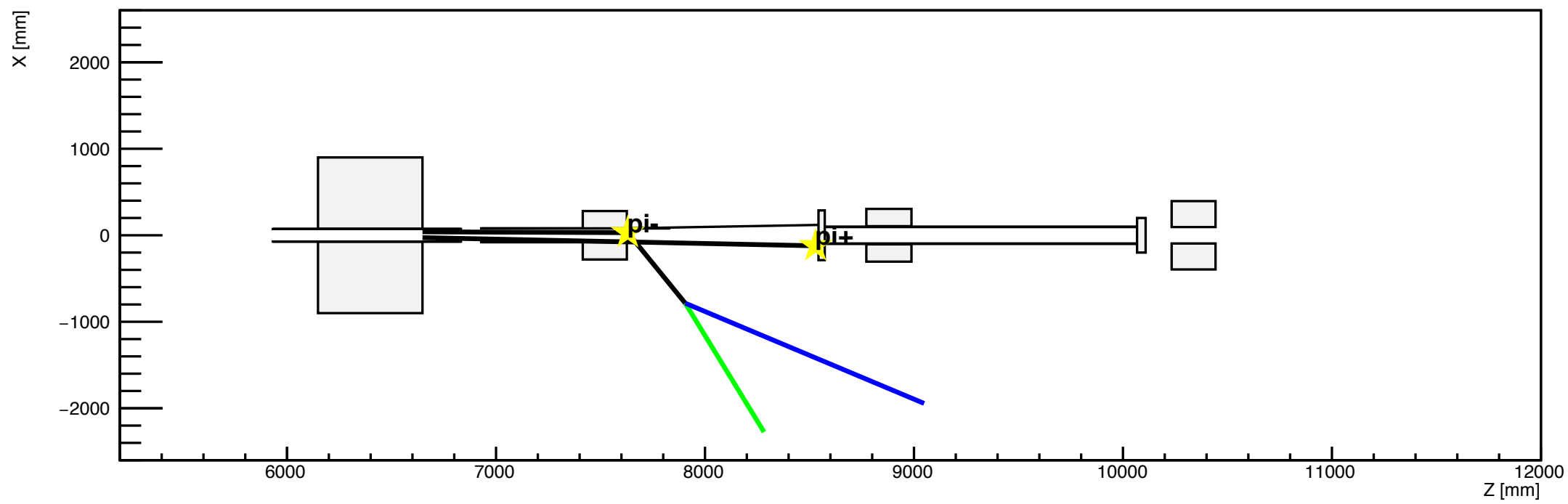

h1

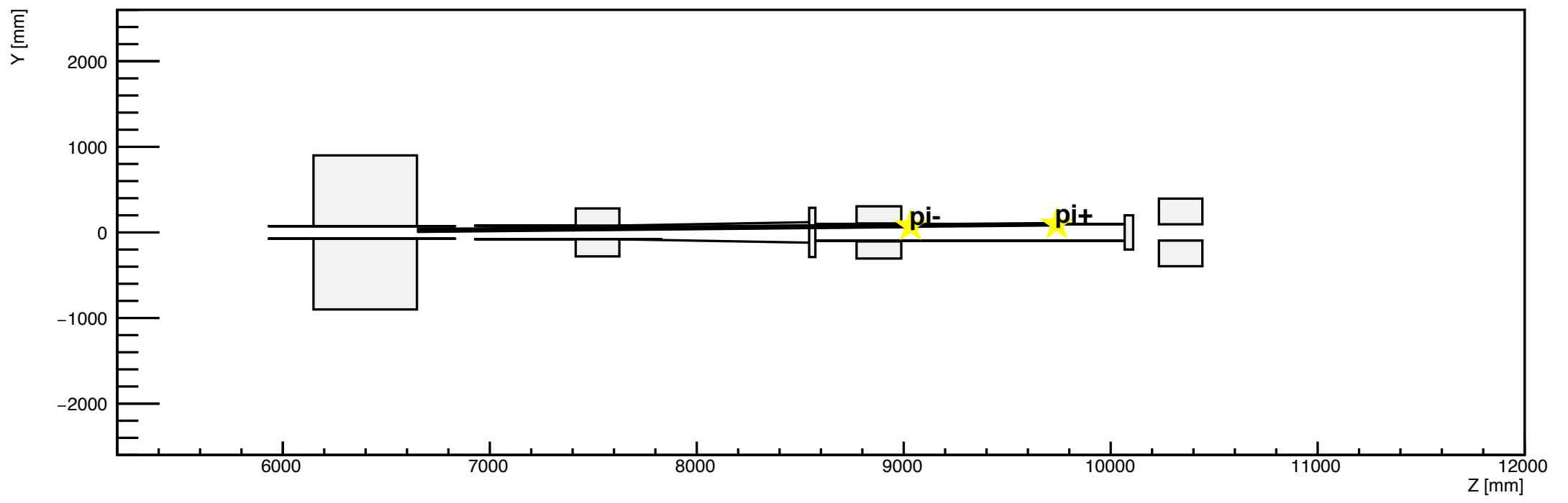

h2

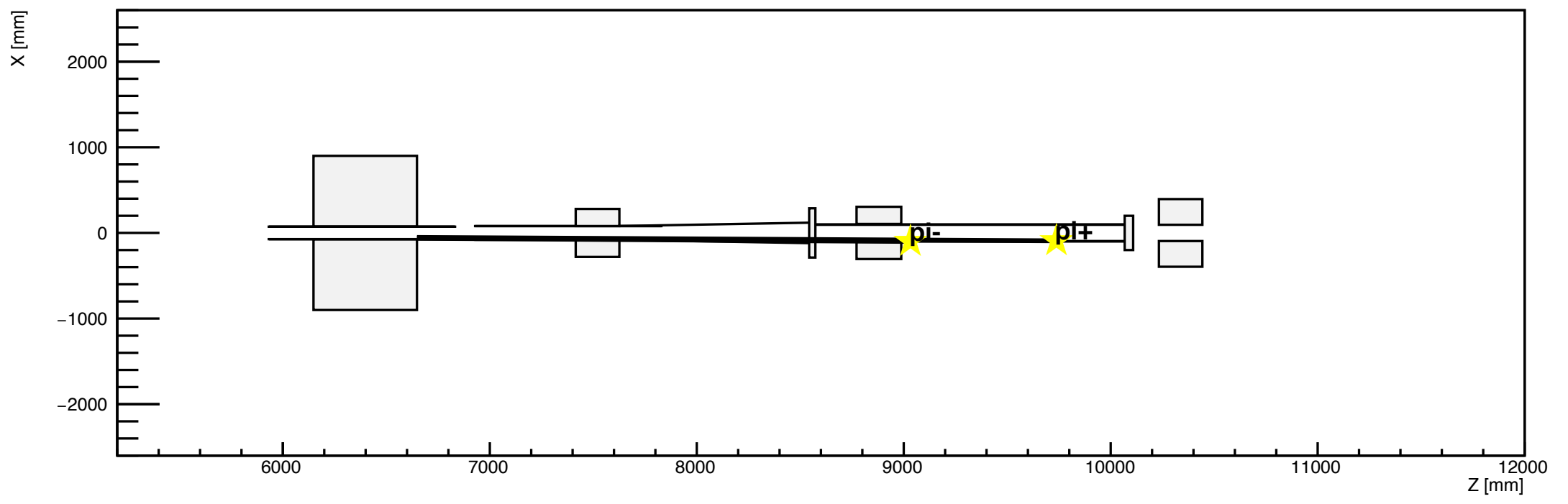

h1

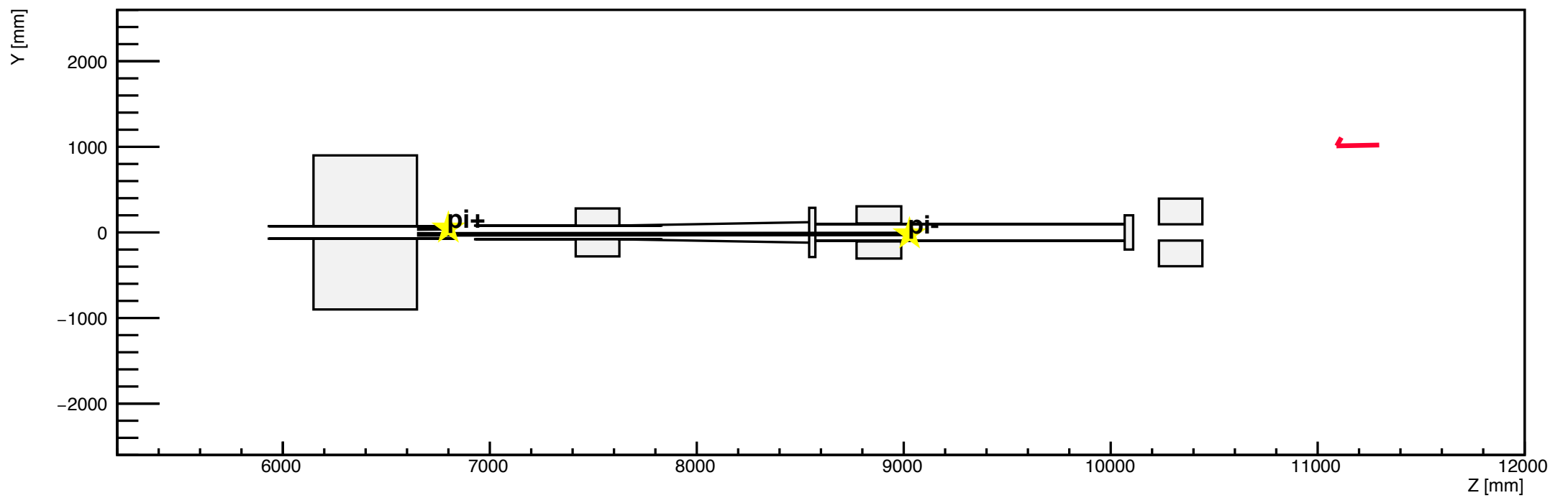

h2

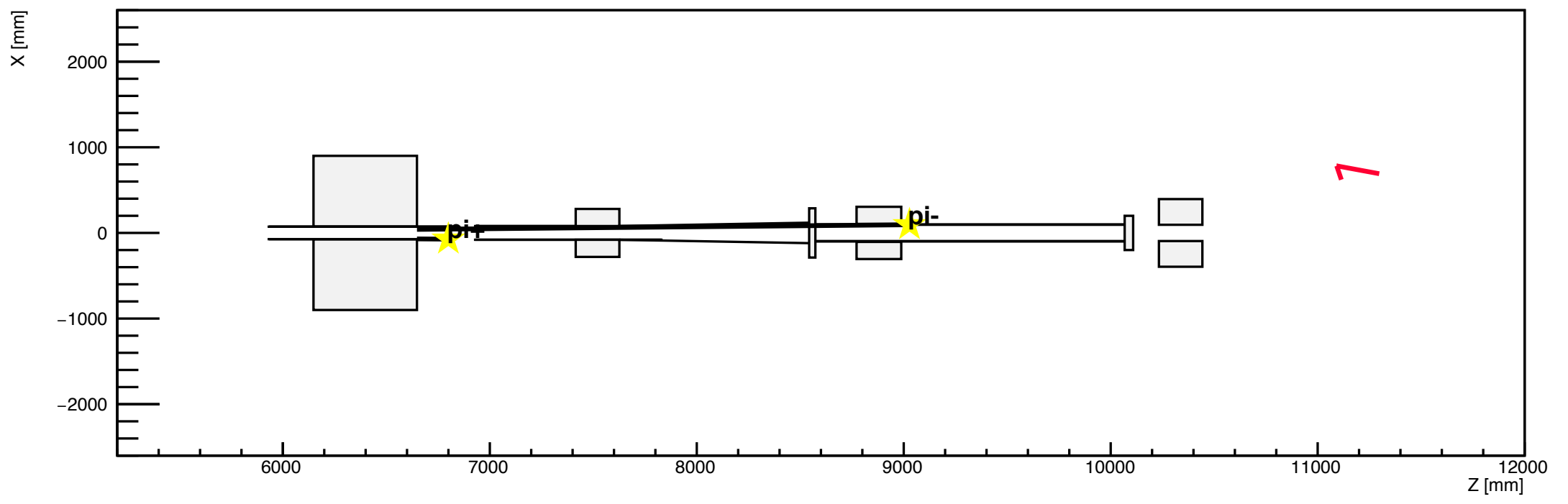

h1

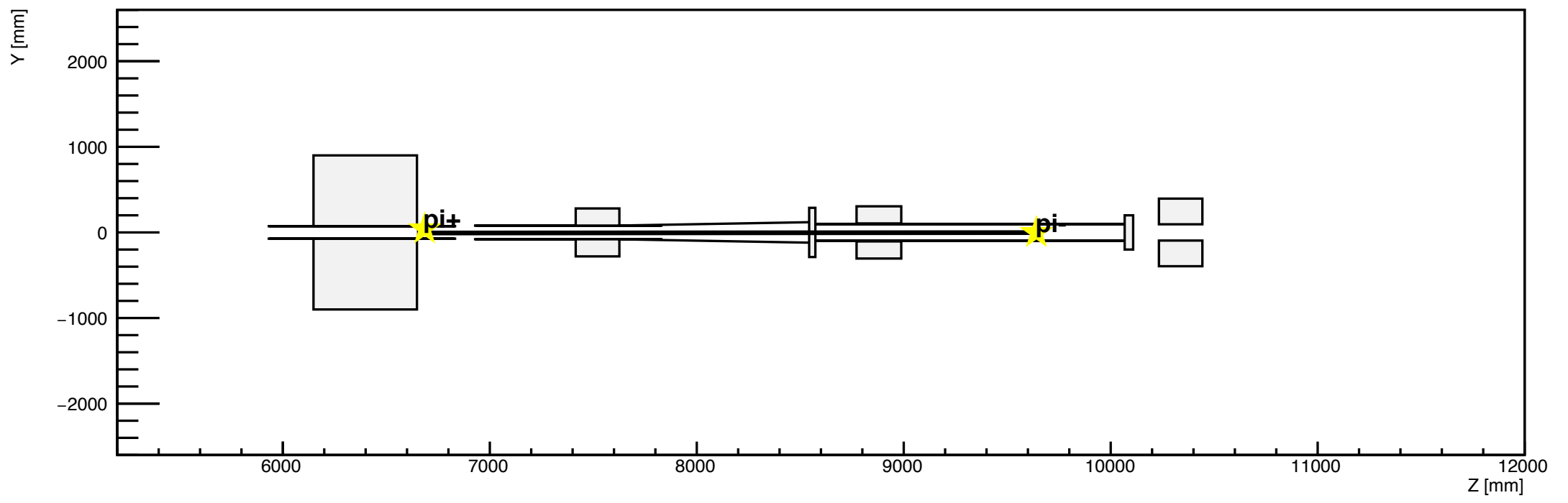

h2

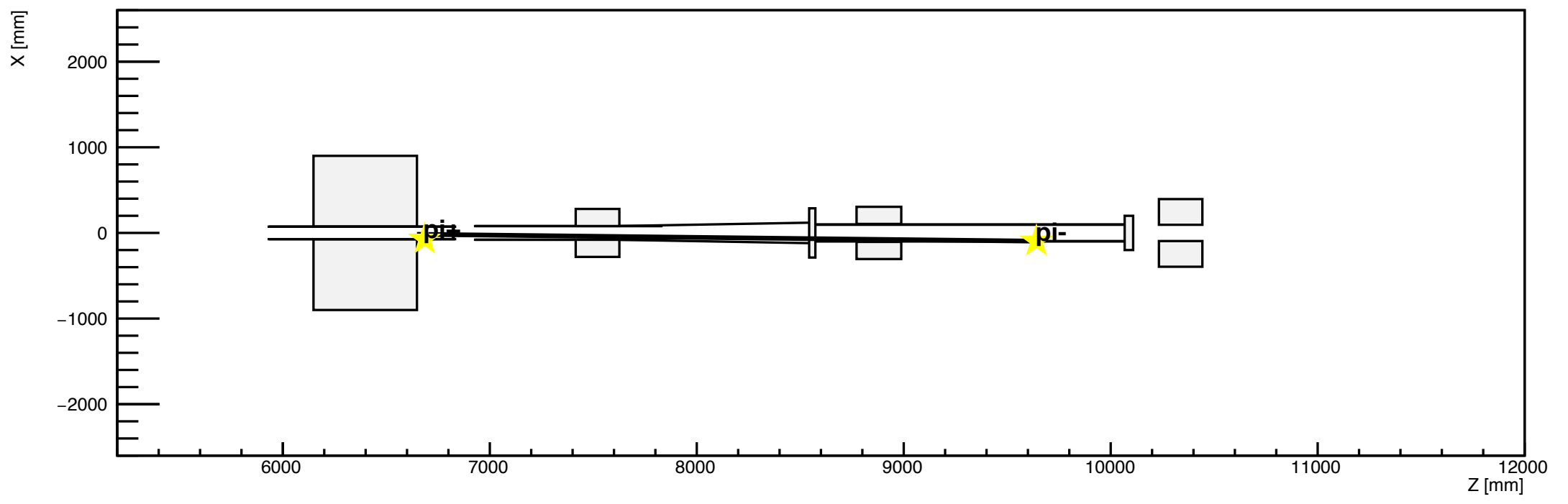

h1

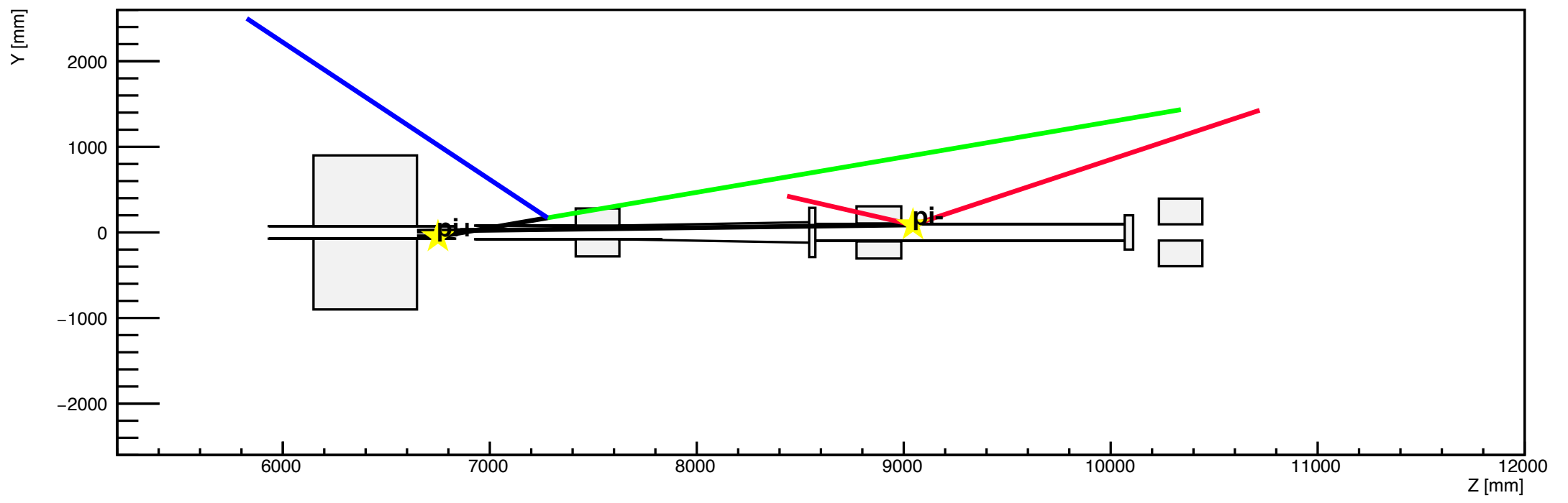

h2

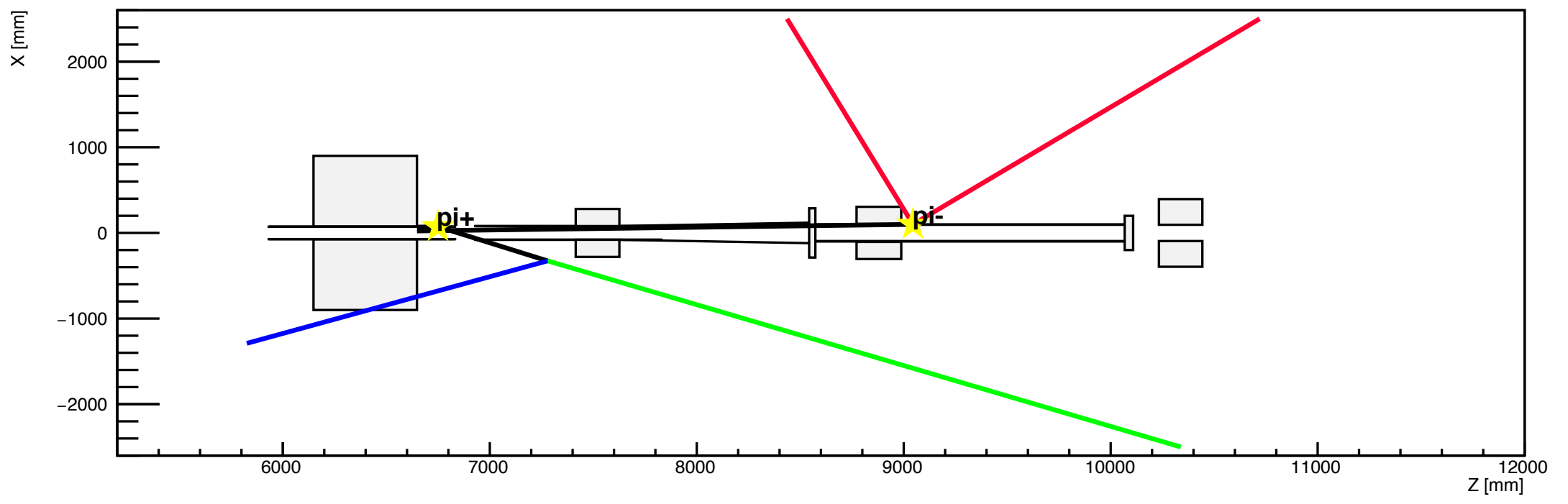

h1

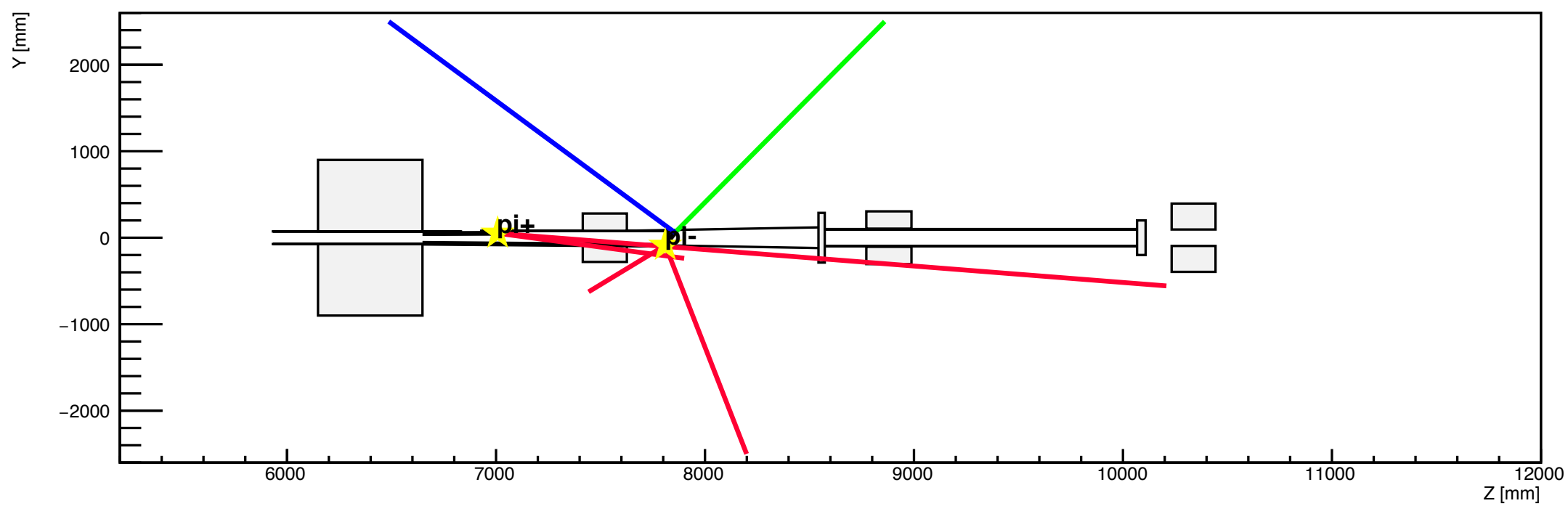

h2

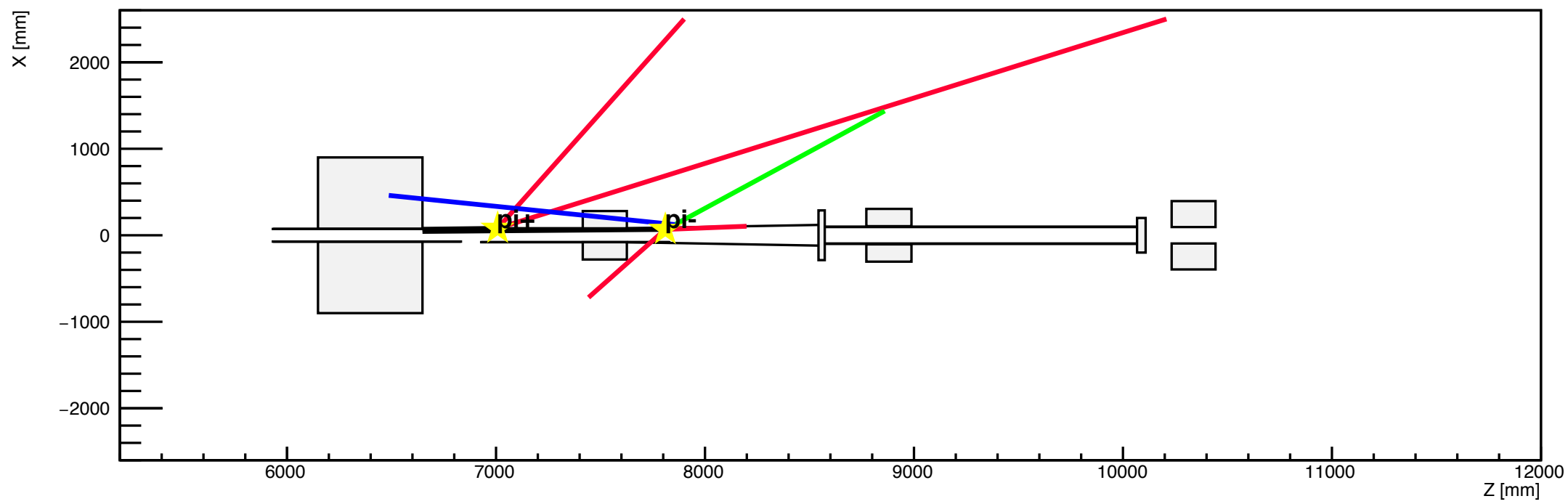

h1

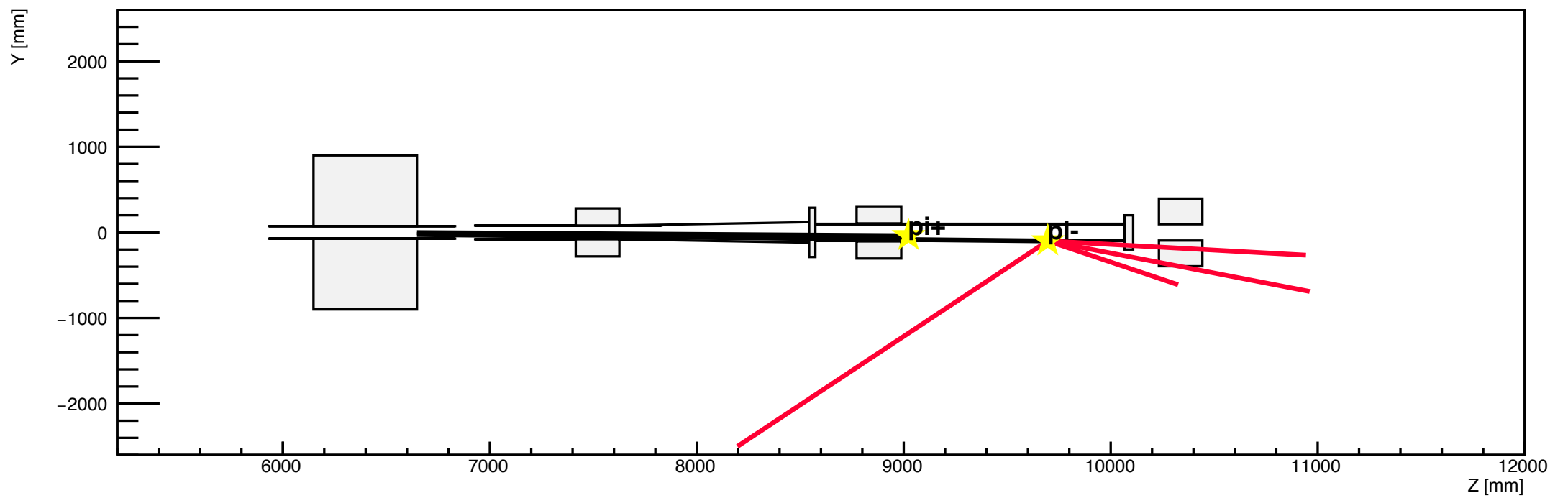

h2

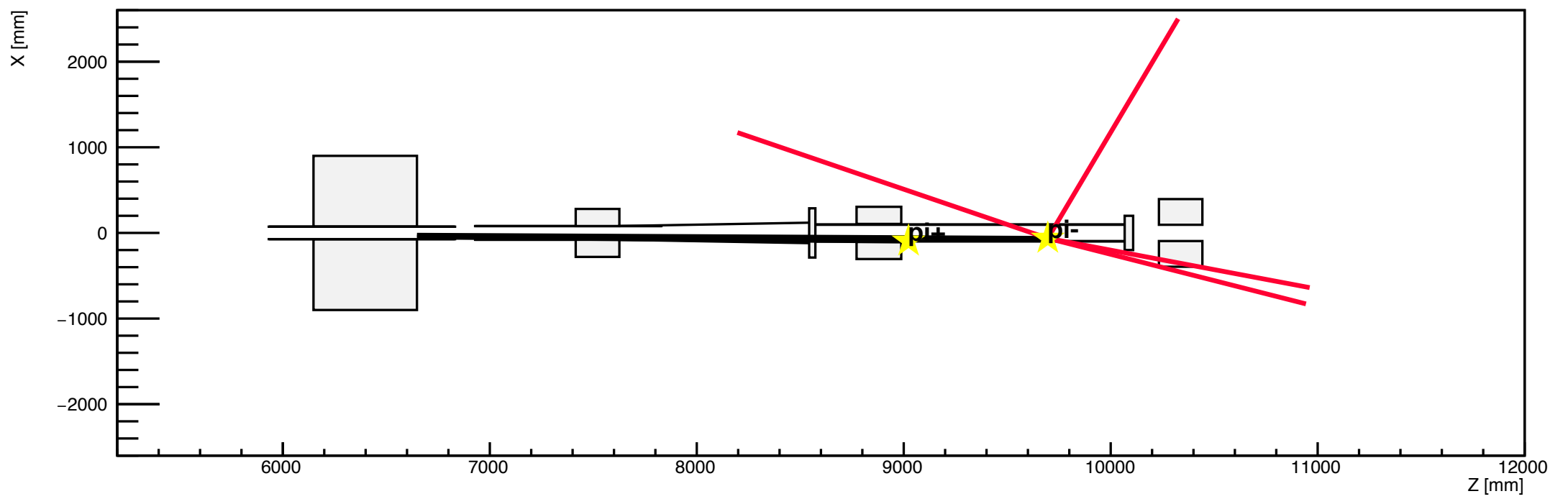

h1

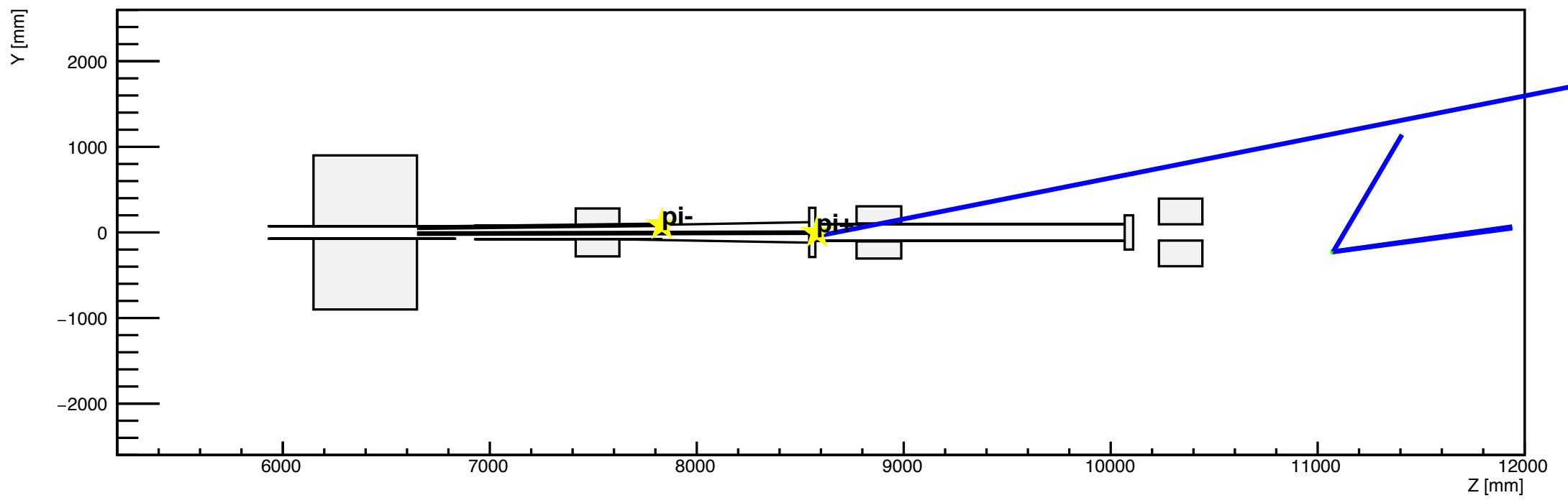

h2

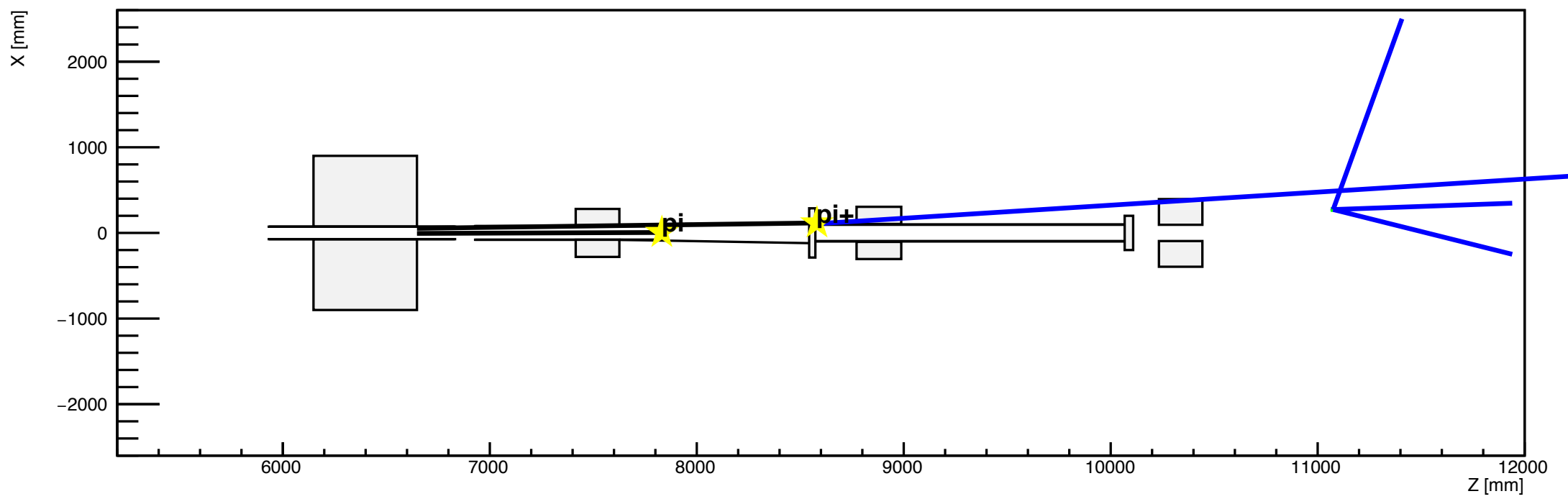

h1

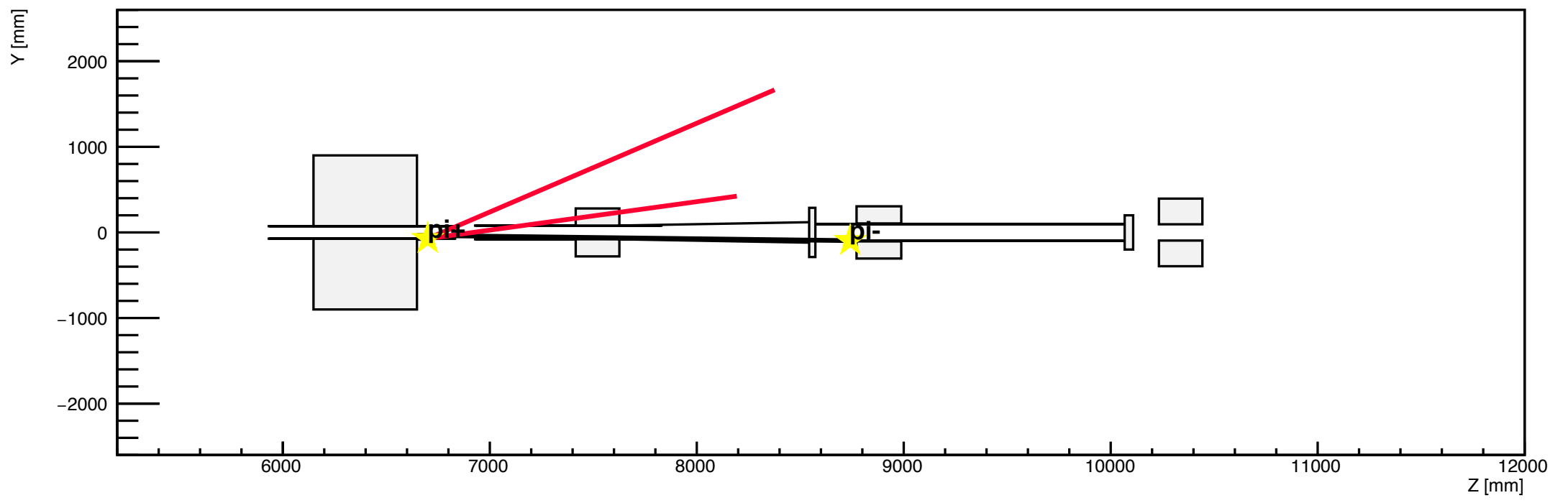

h2

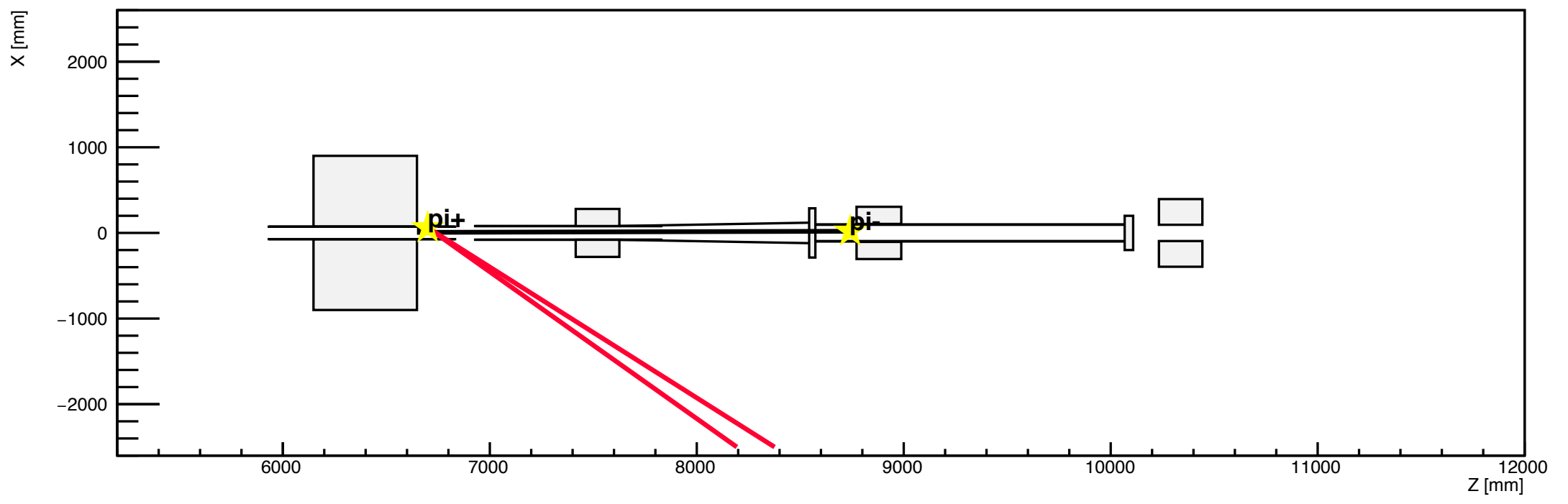

h1

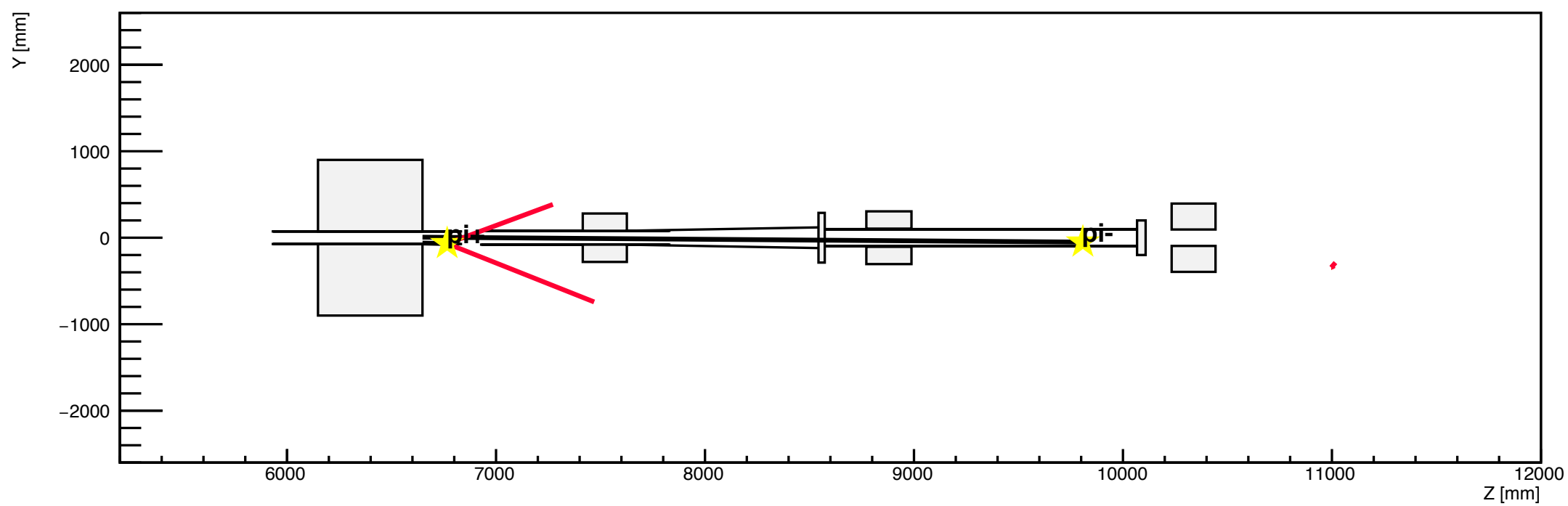

h2

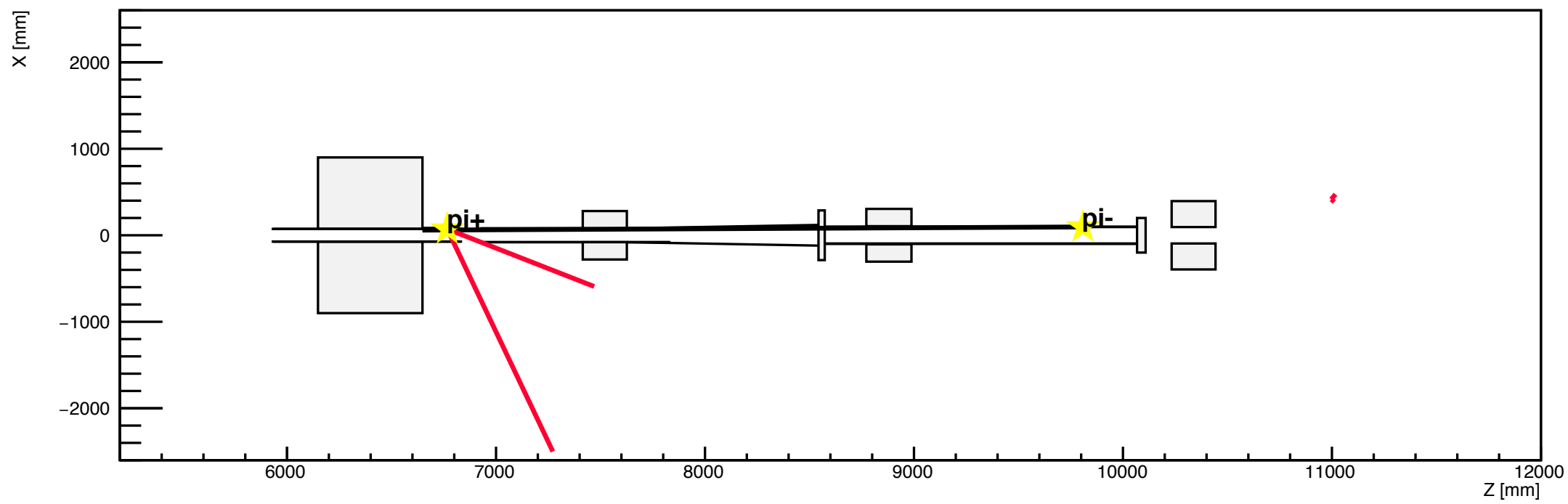

h1

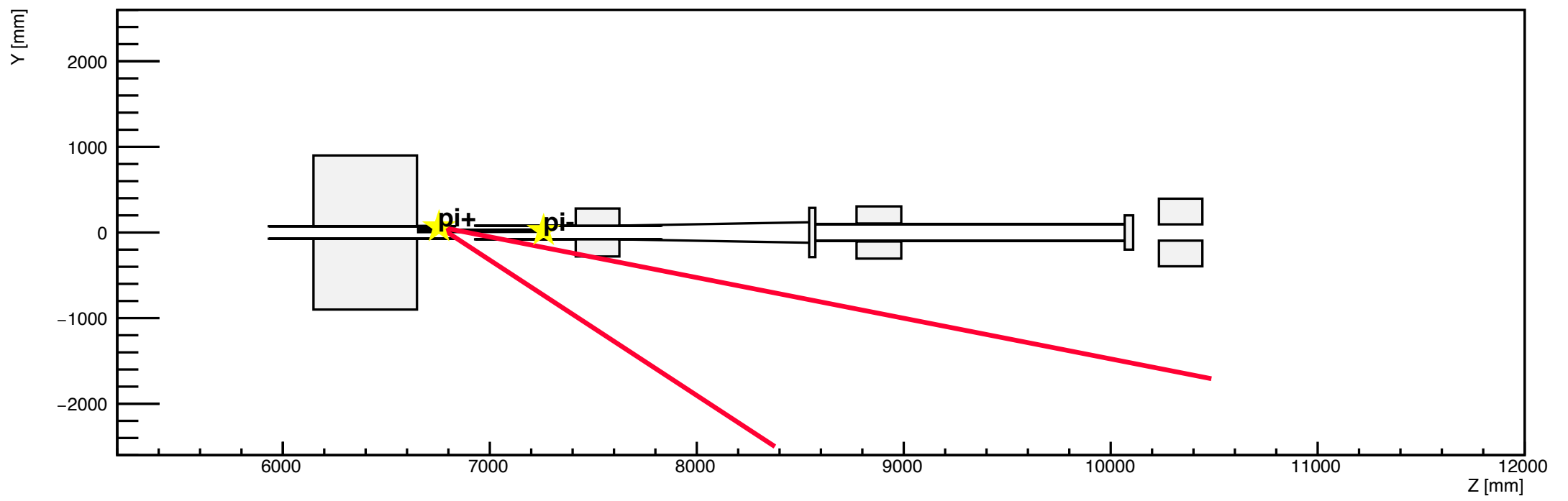

h2

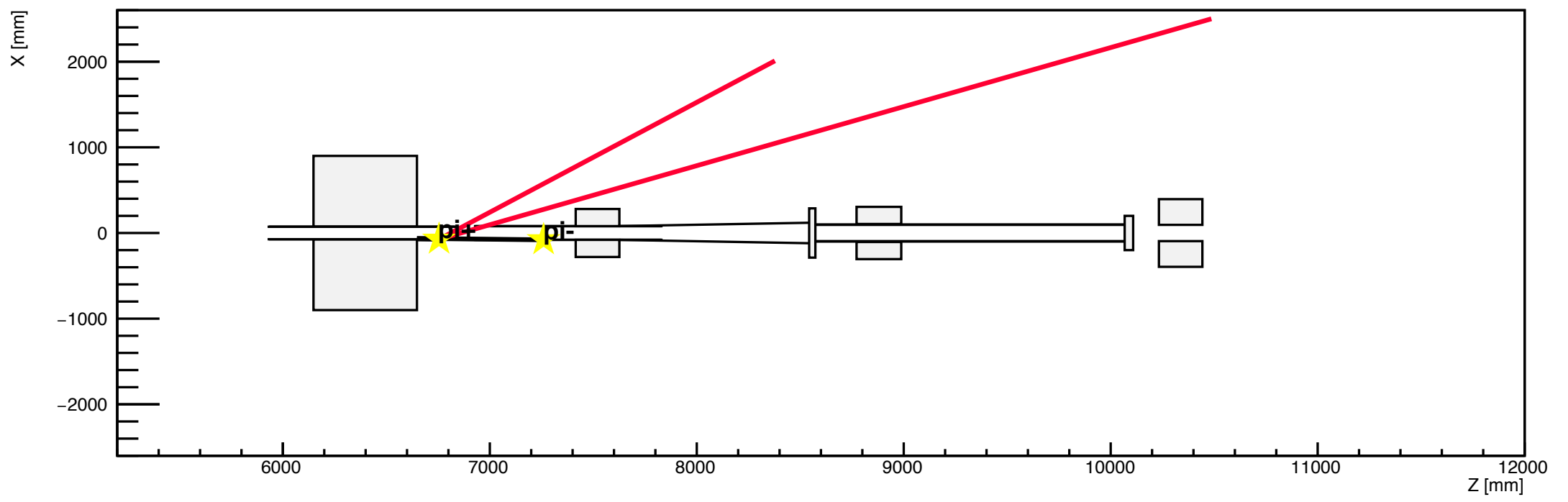

h1

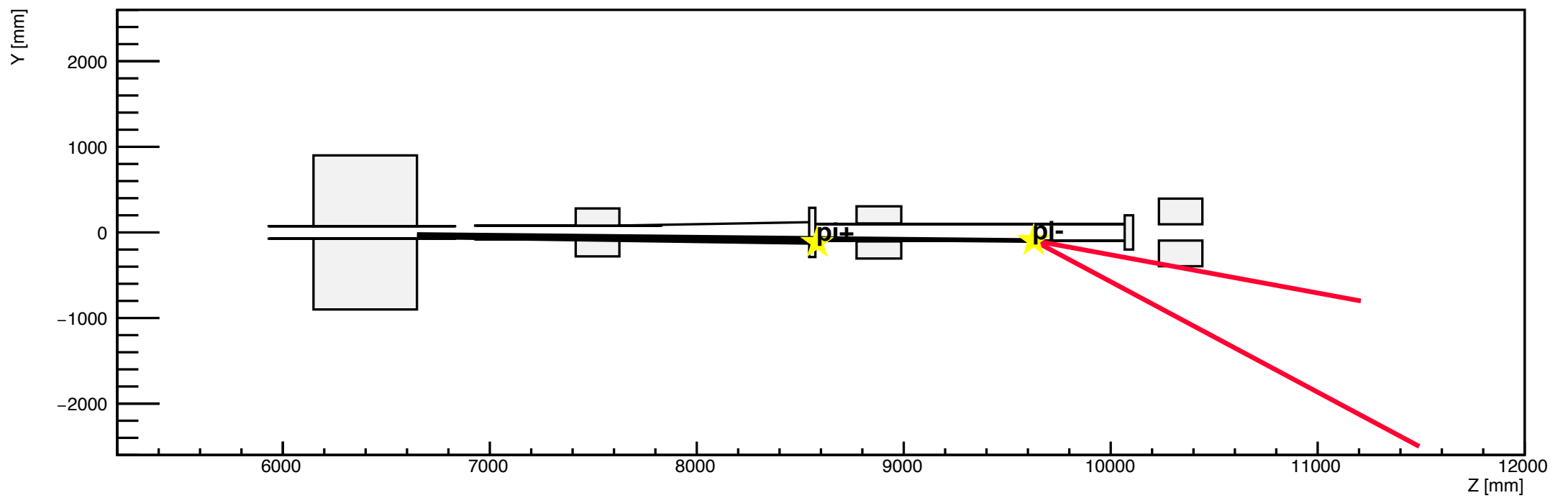

h2

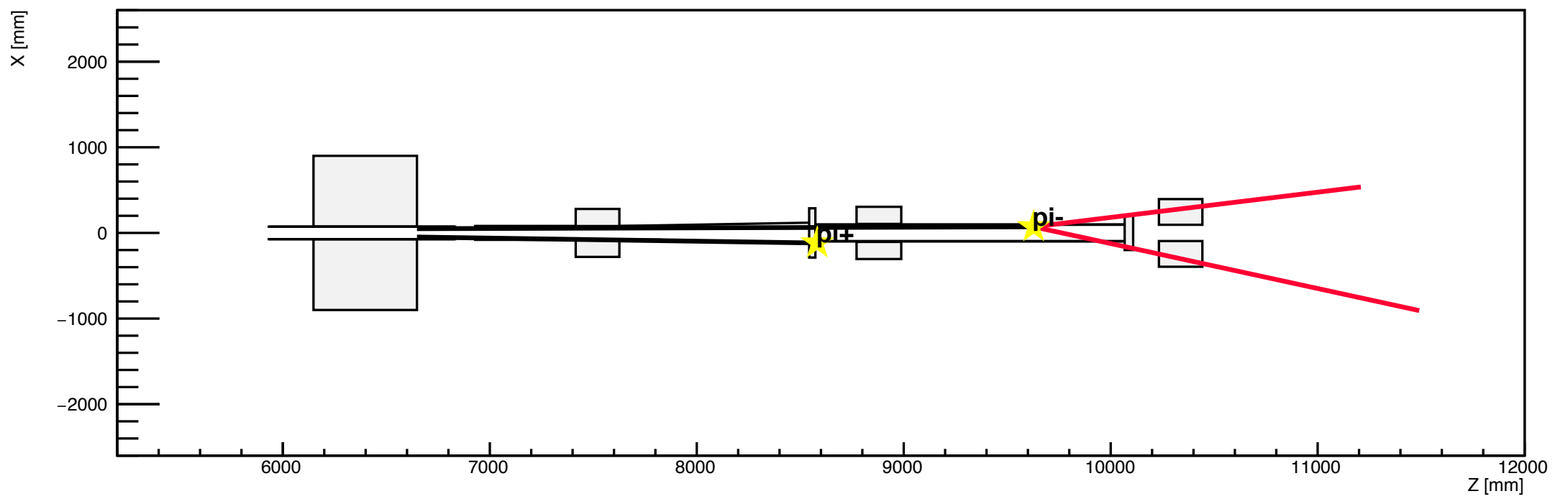

h1

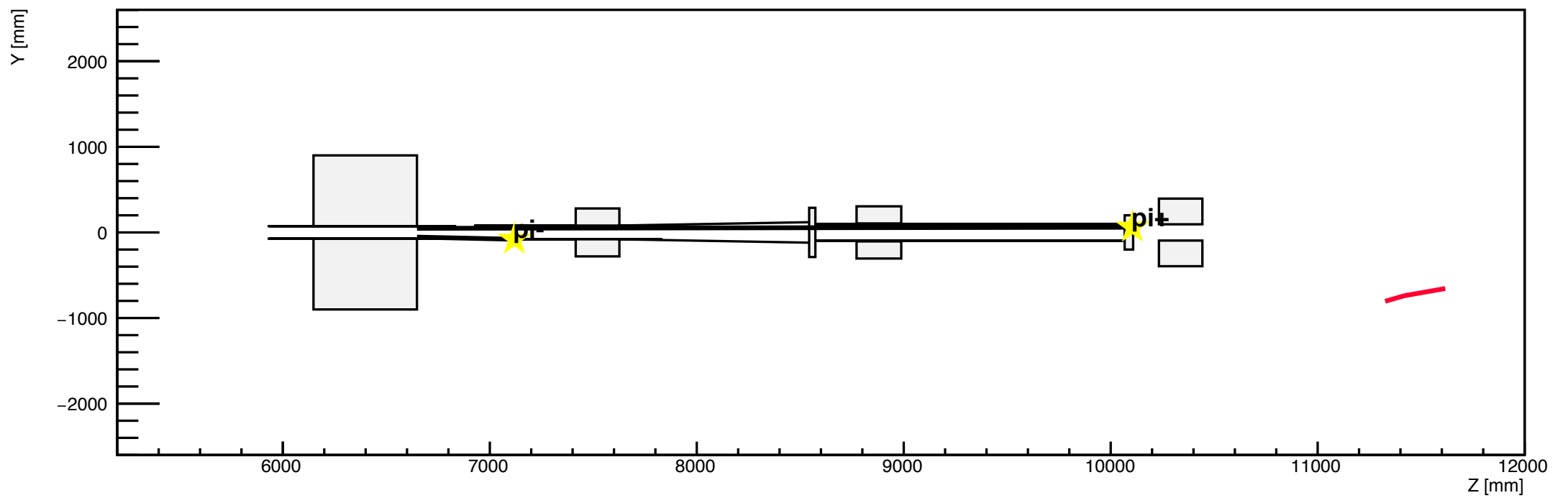

h2

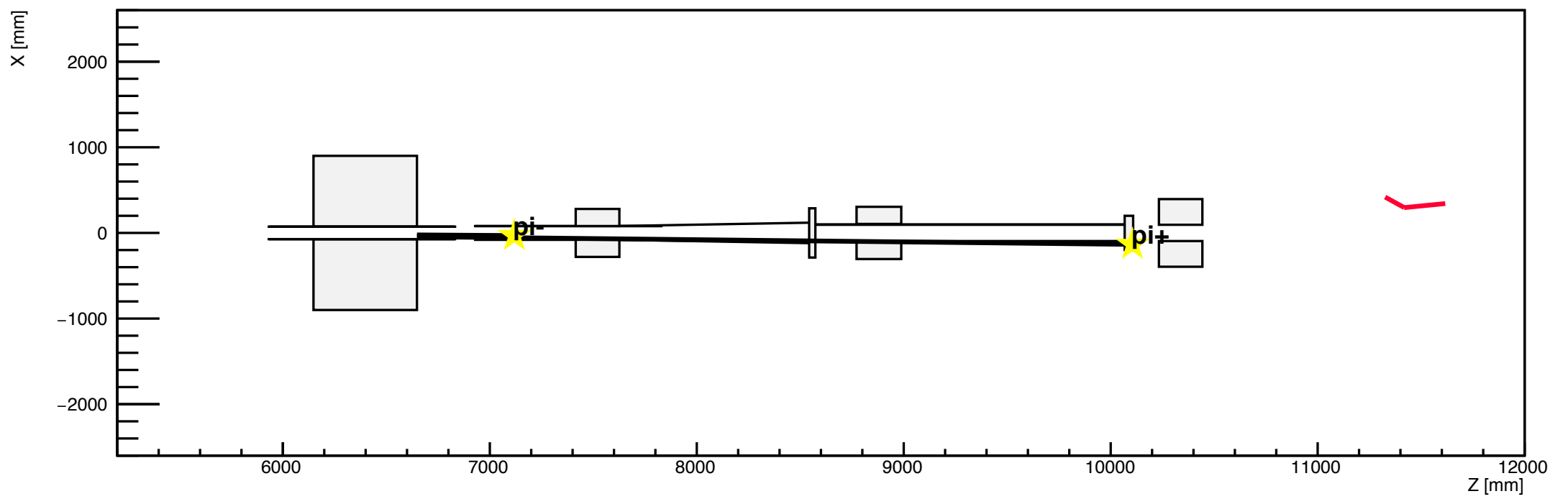

h1

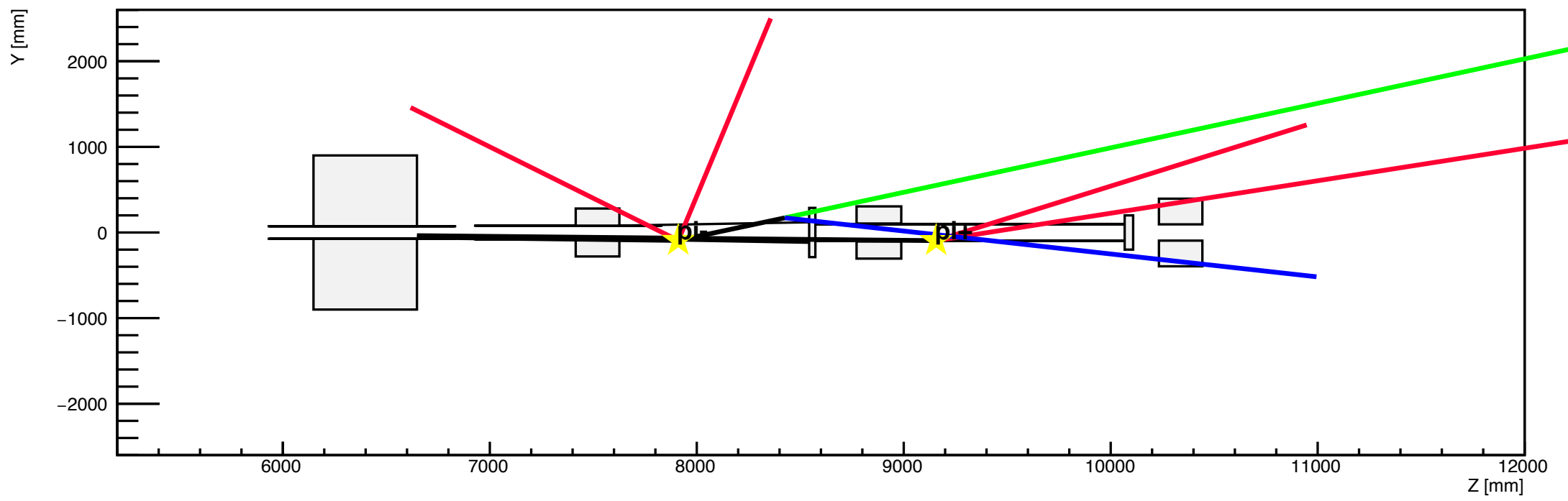

h2

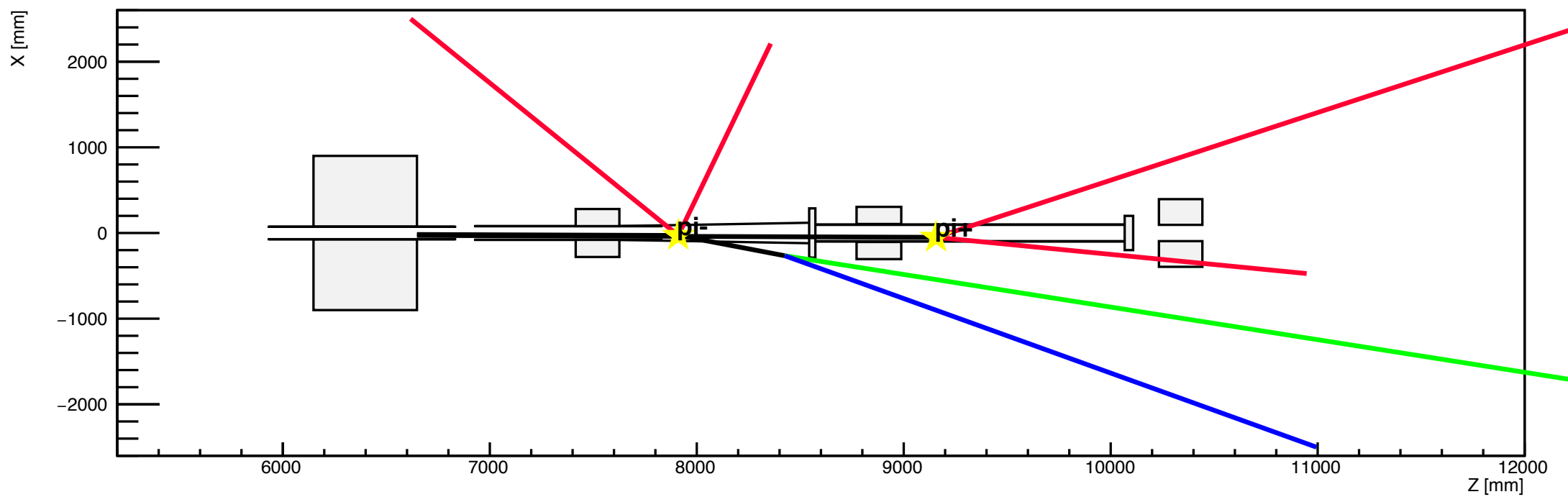

h1

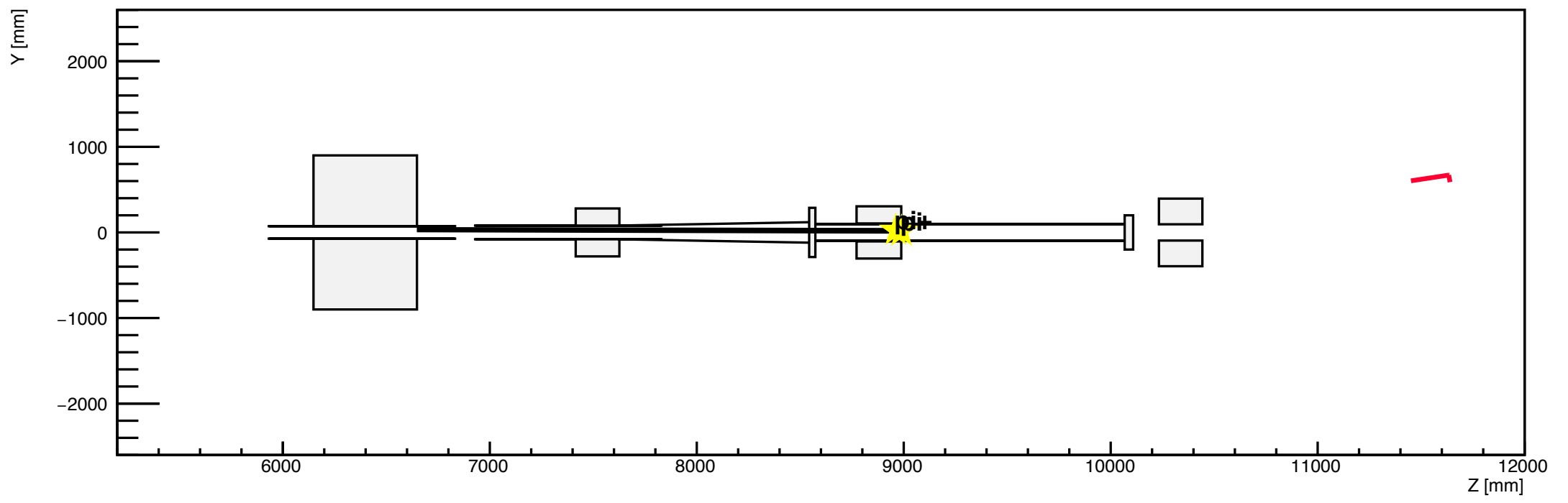

h2

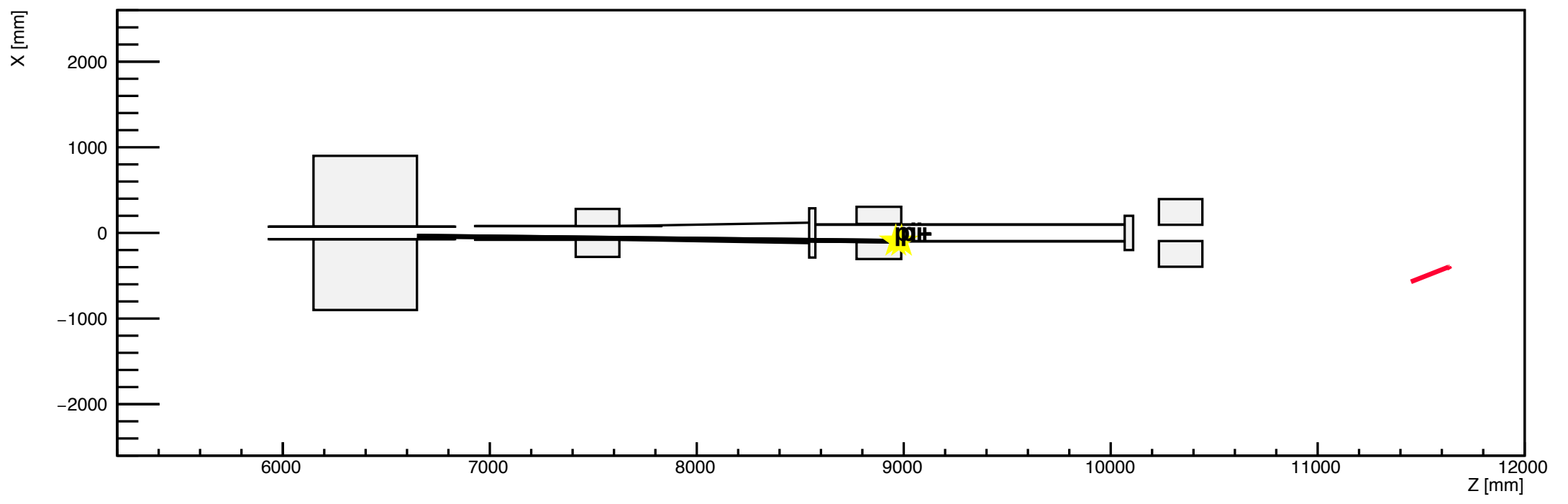

h1

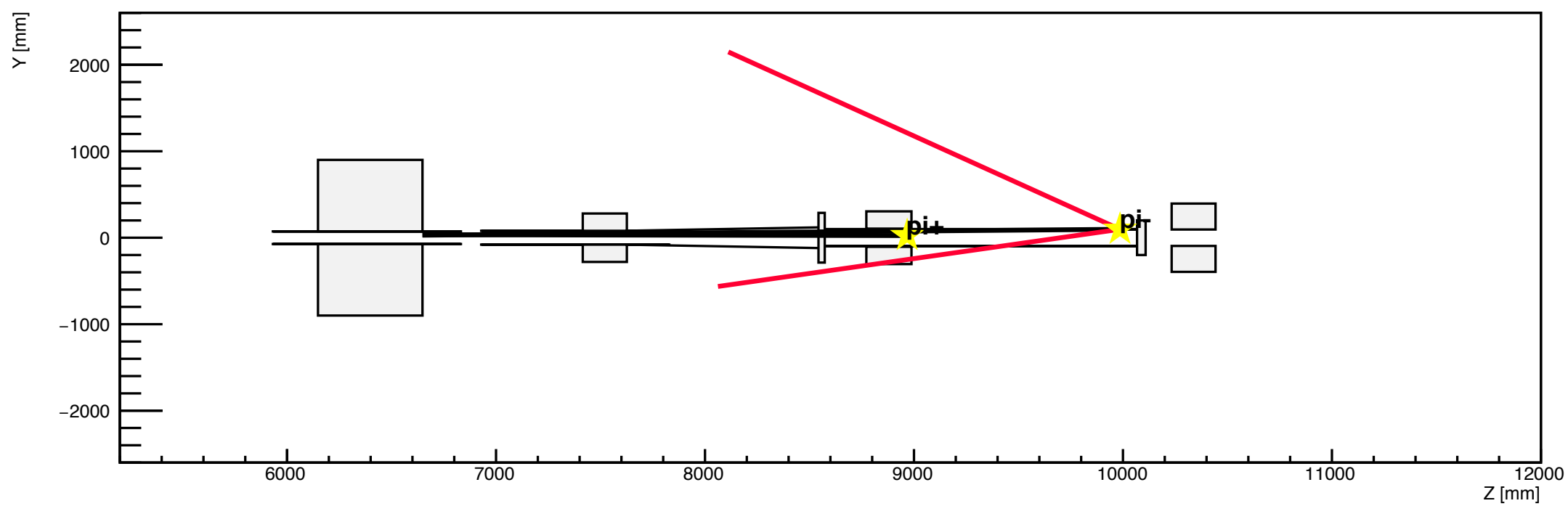

h2

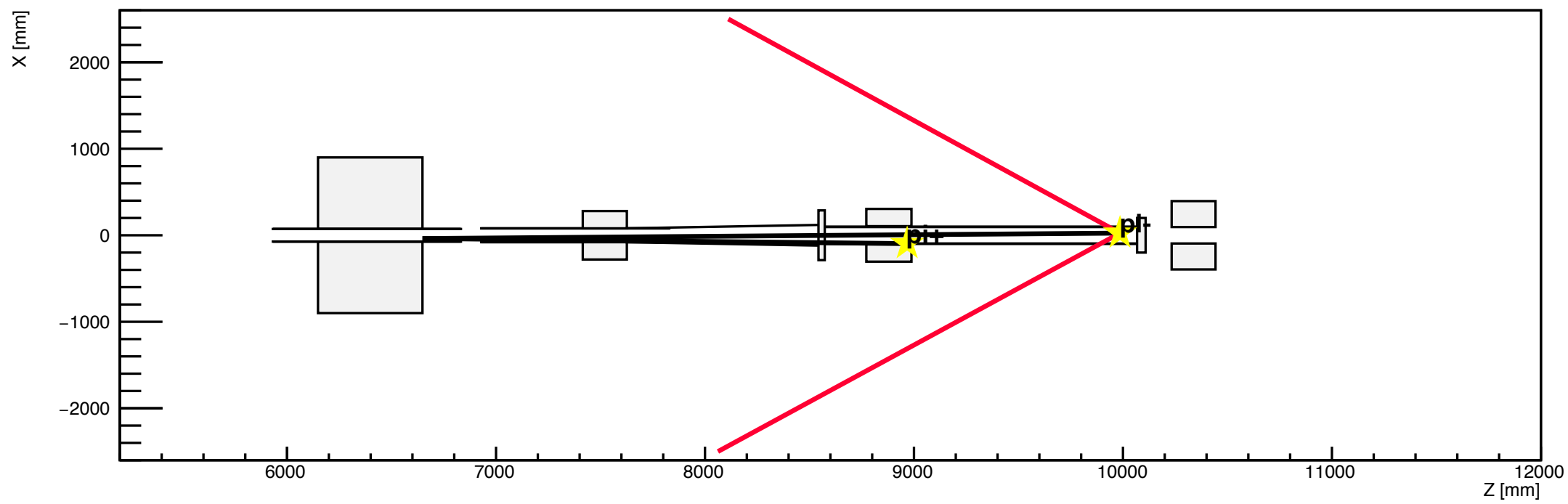

h1

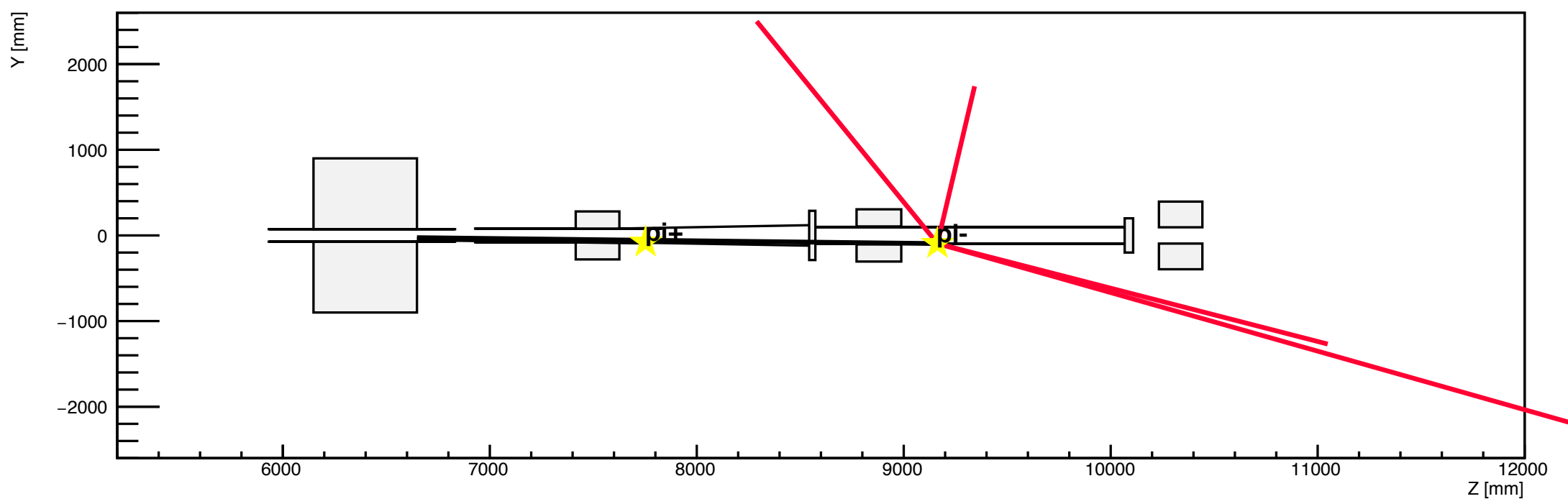

h2

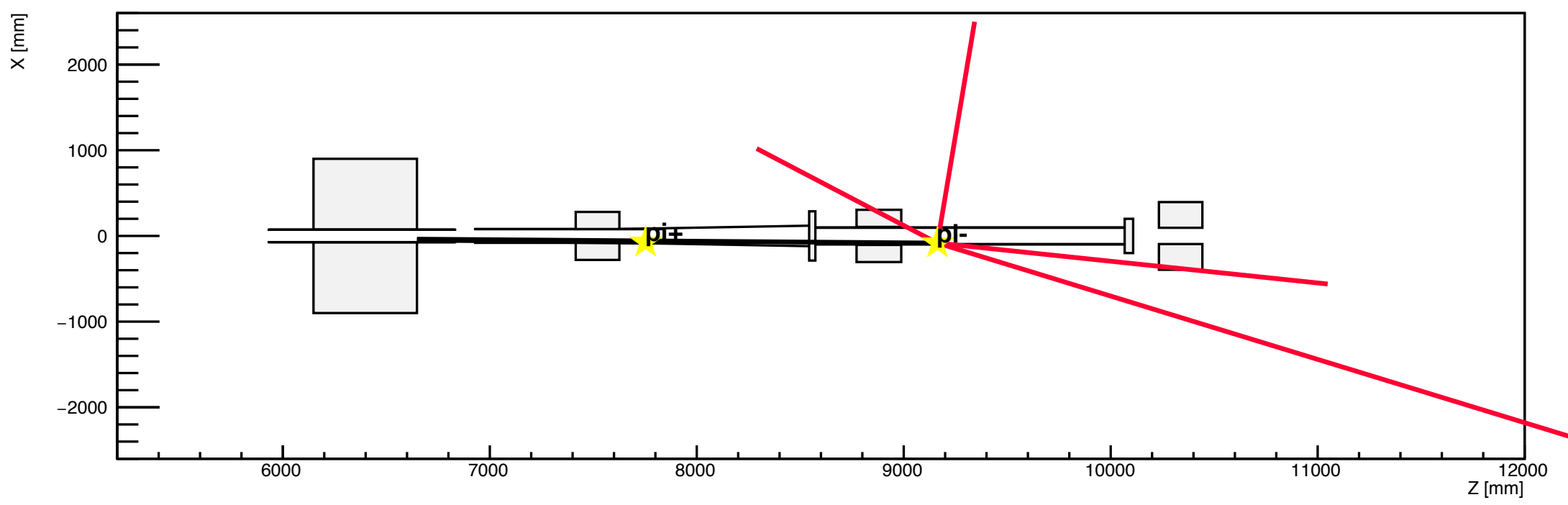

h1

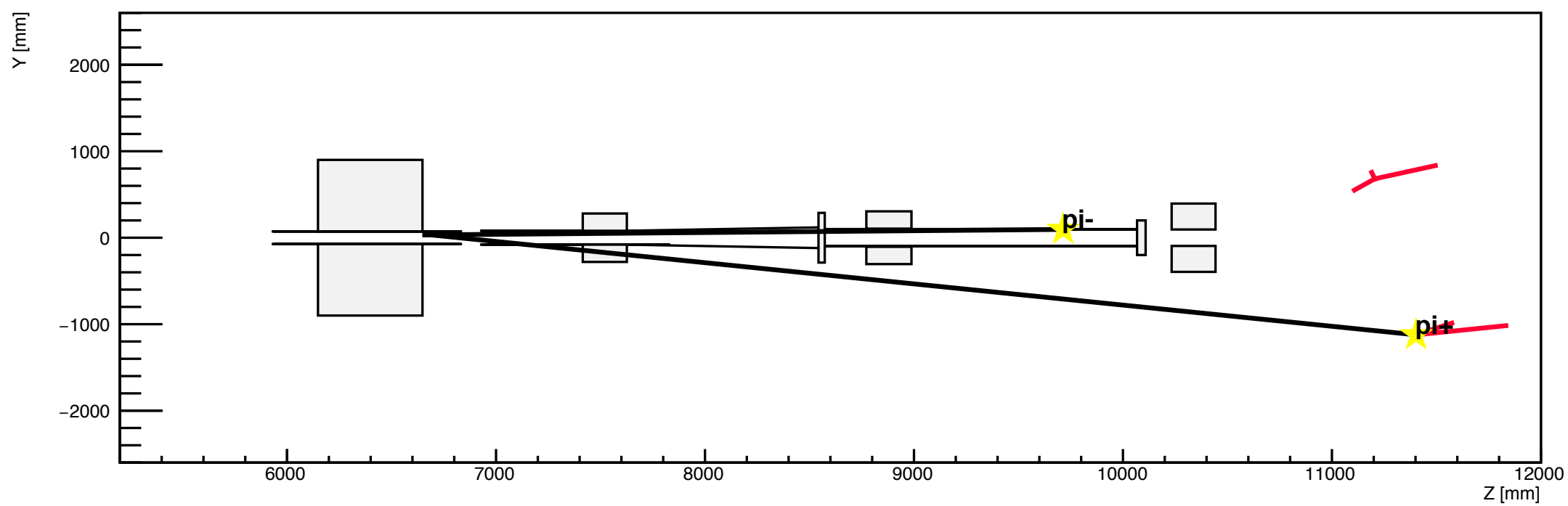

h2

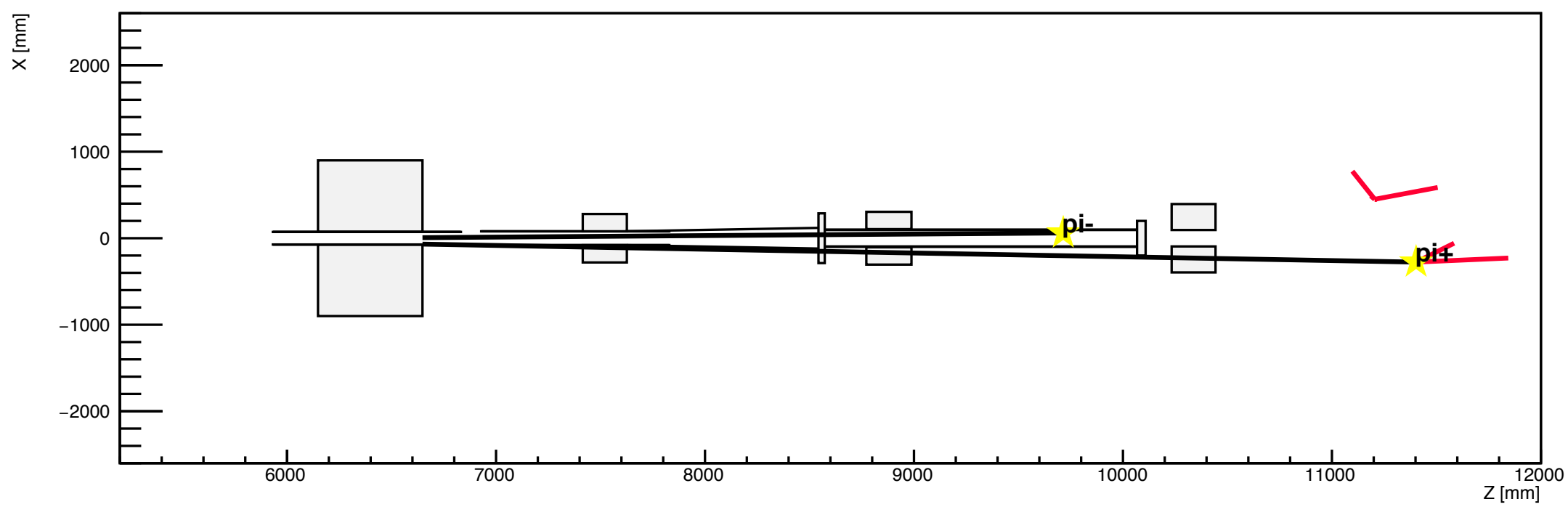

h1

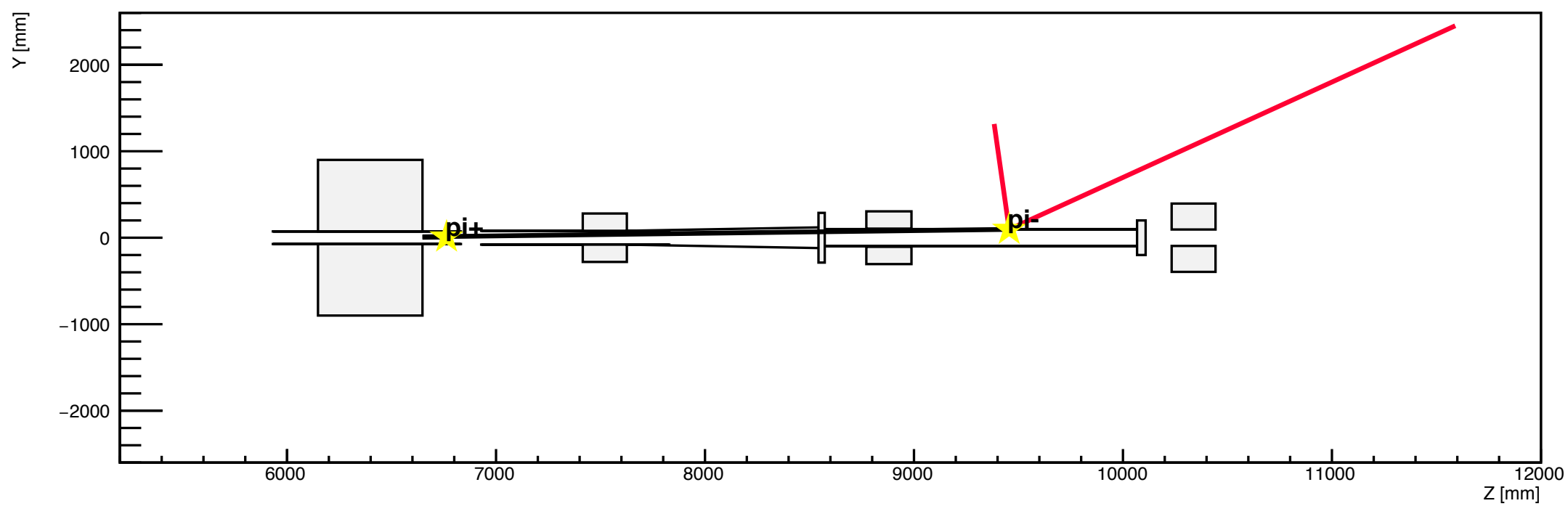

h2

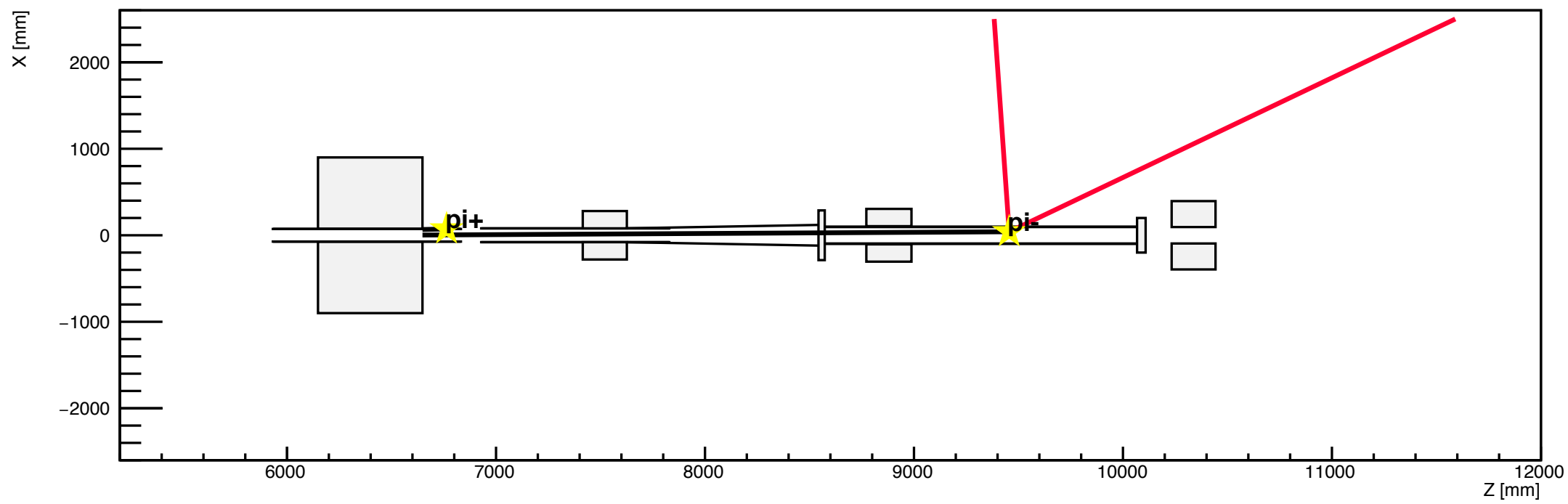

h1

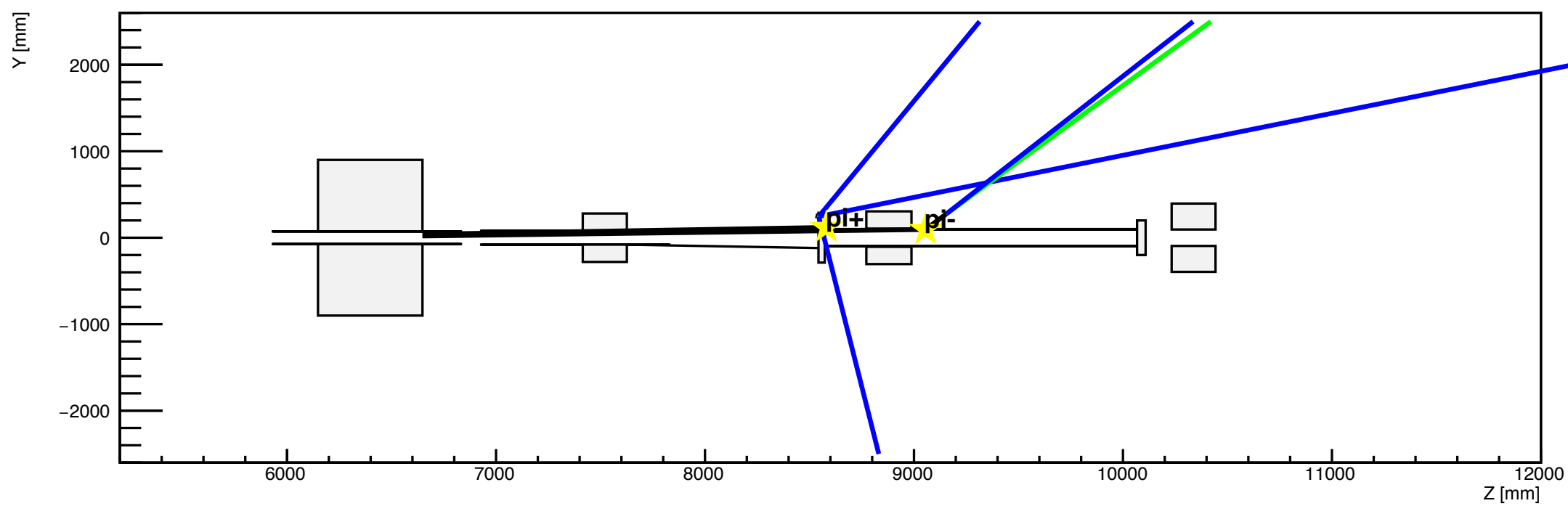

h2

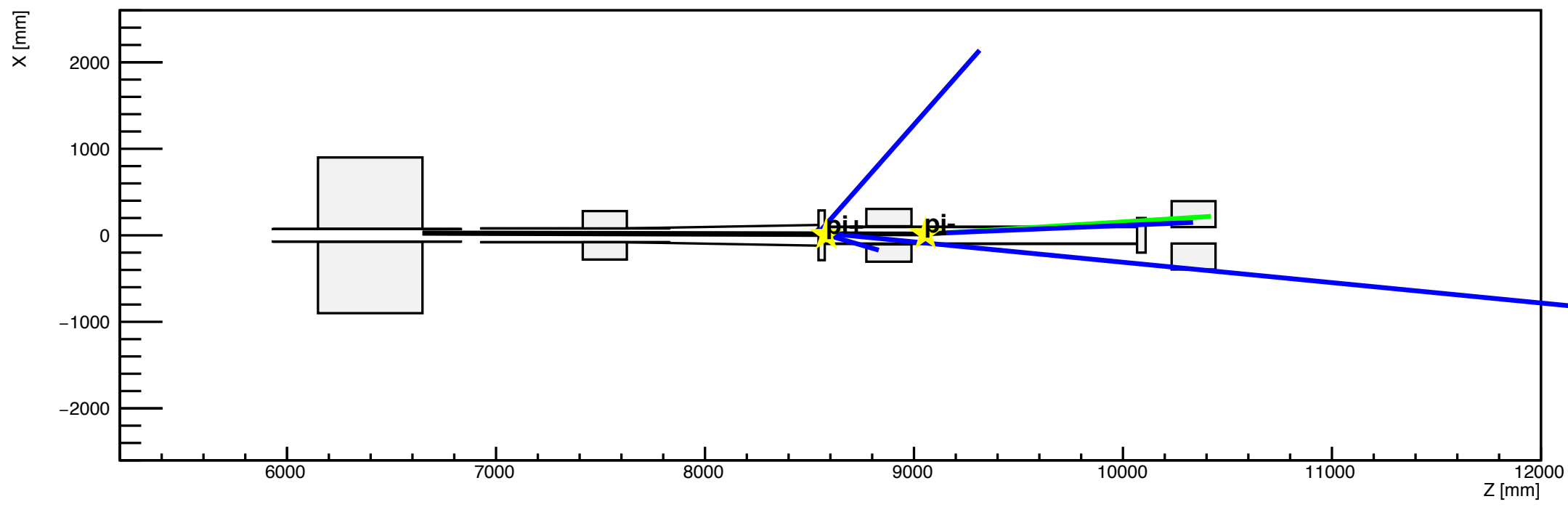

h1

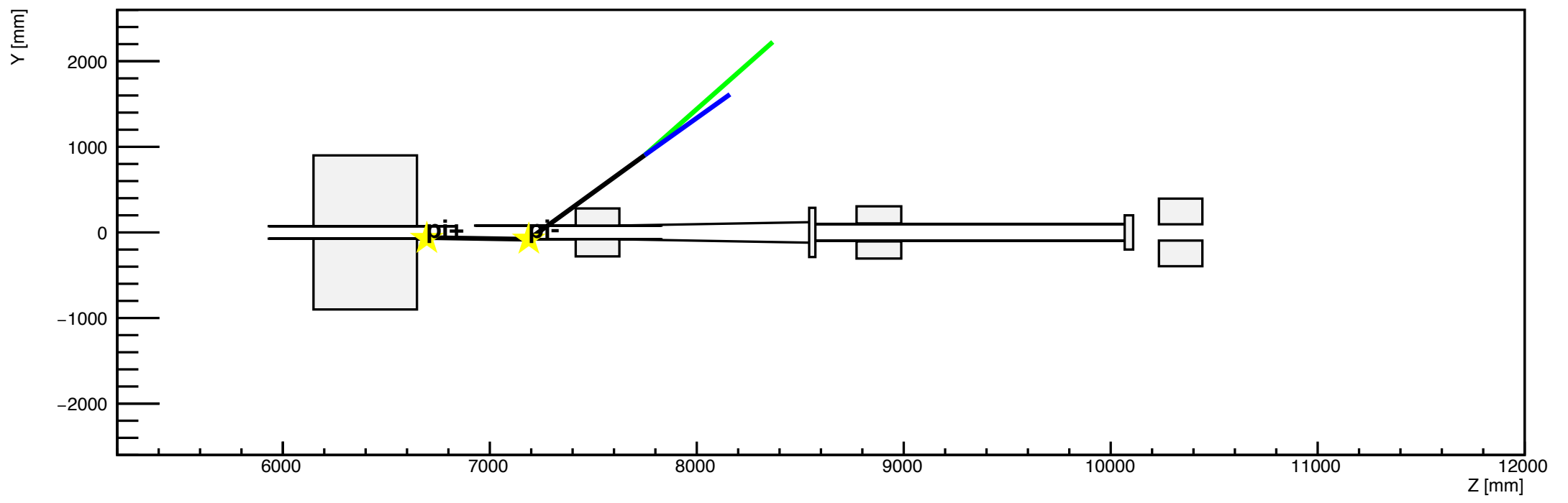

h2

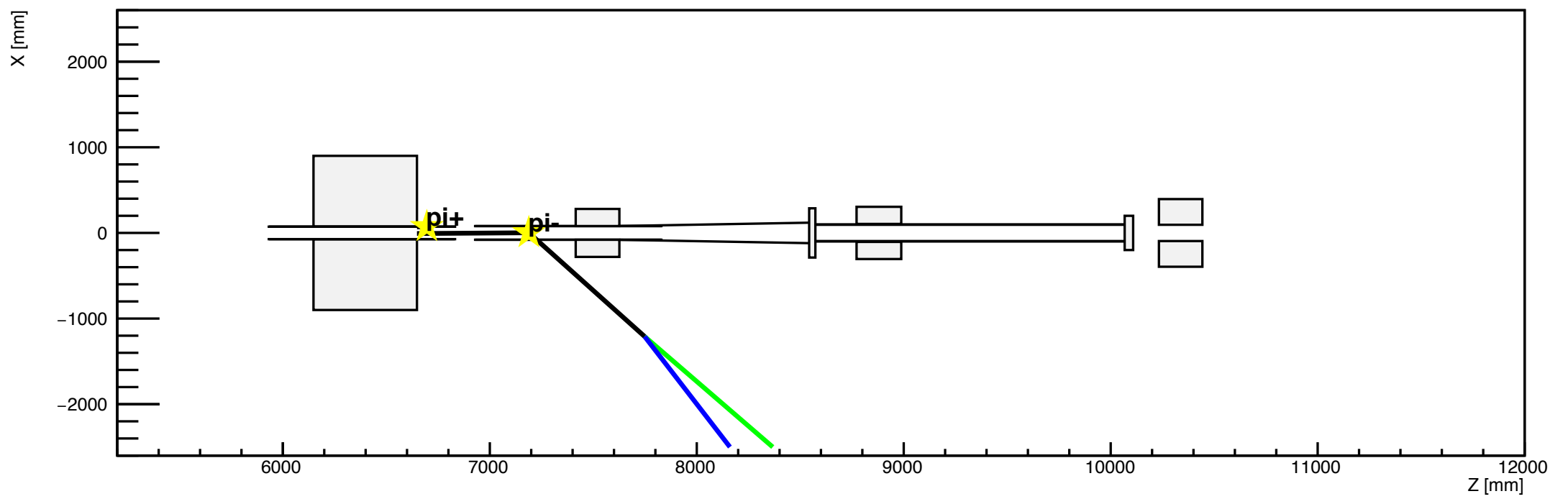

h1

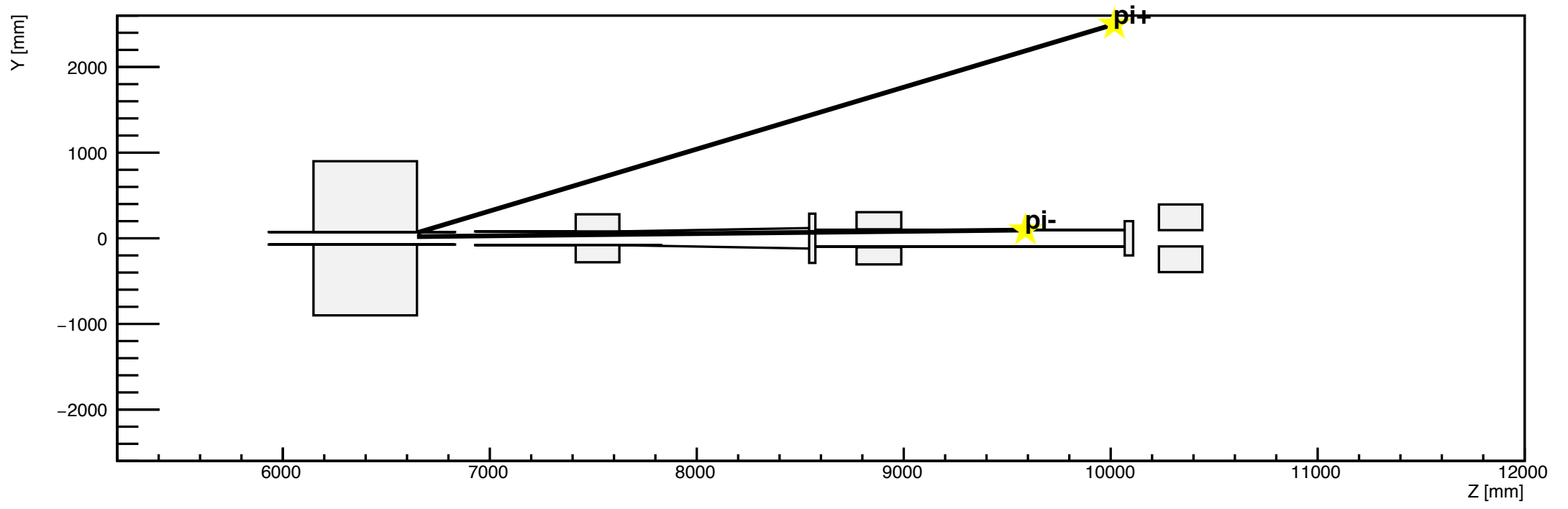

h2

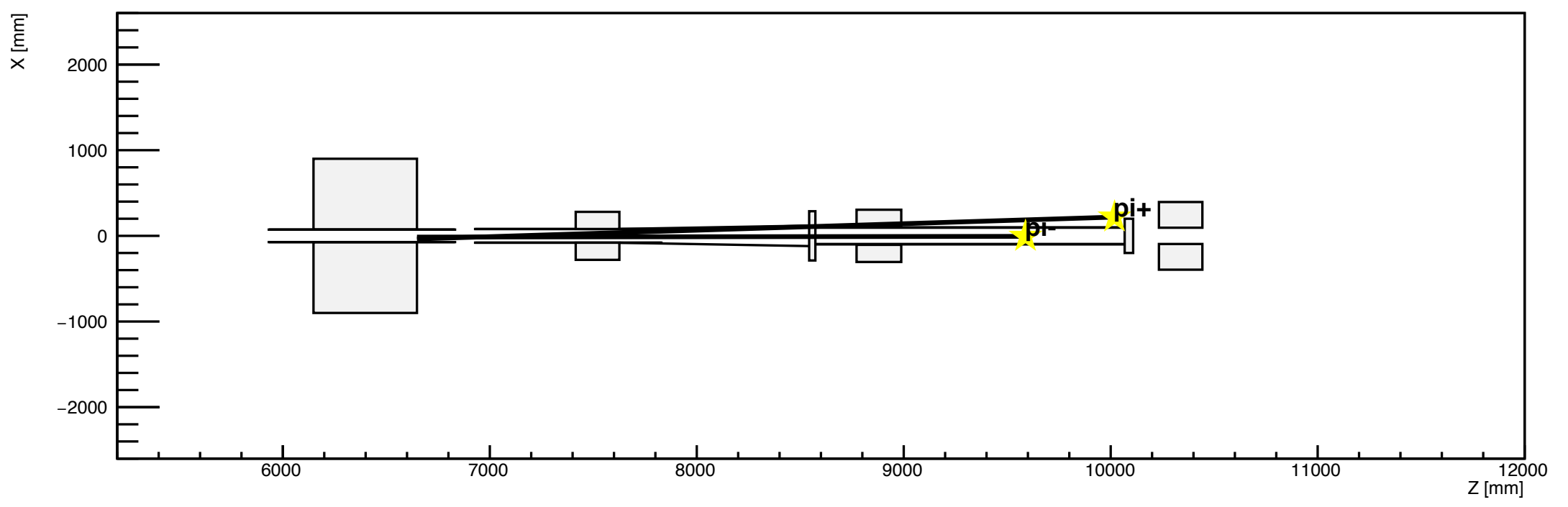

h1

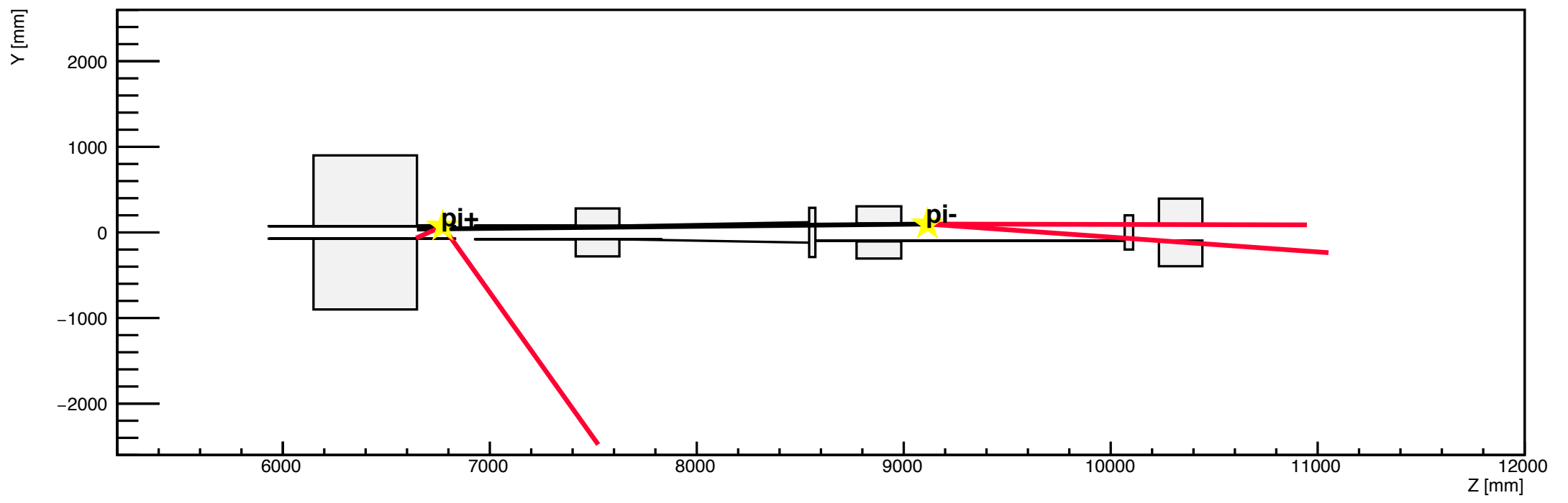

h2

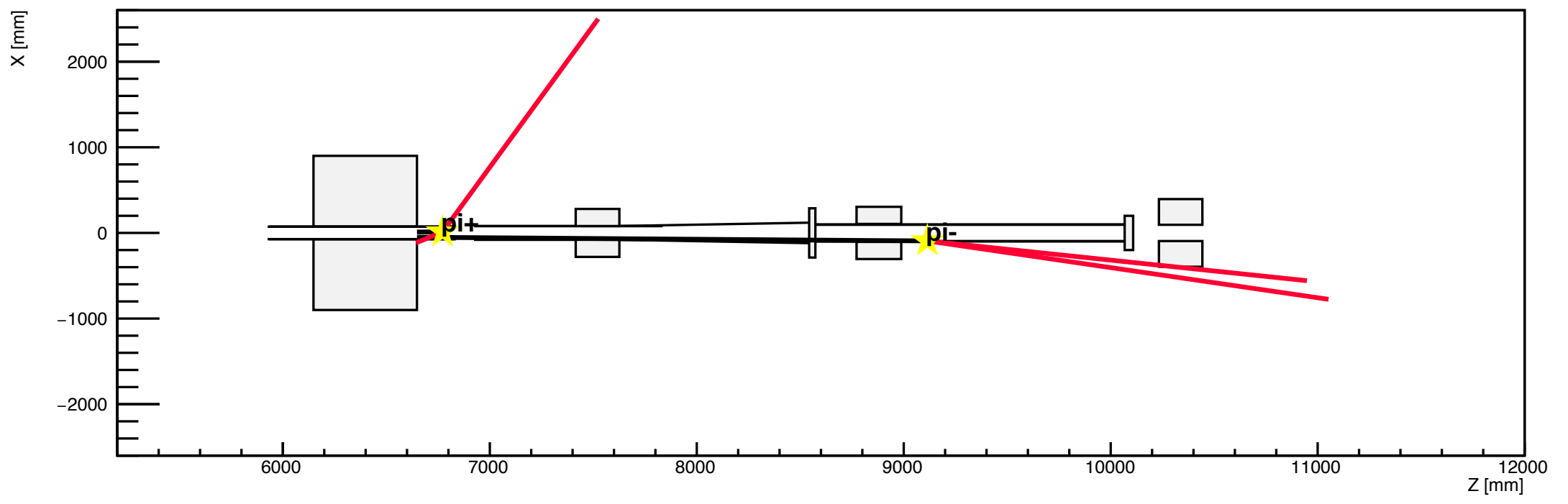

h1

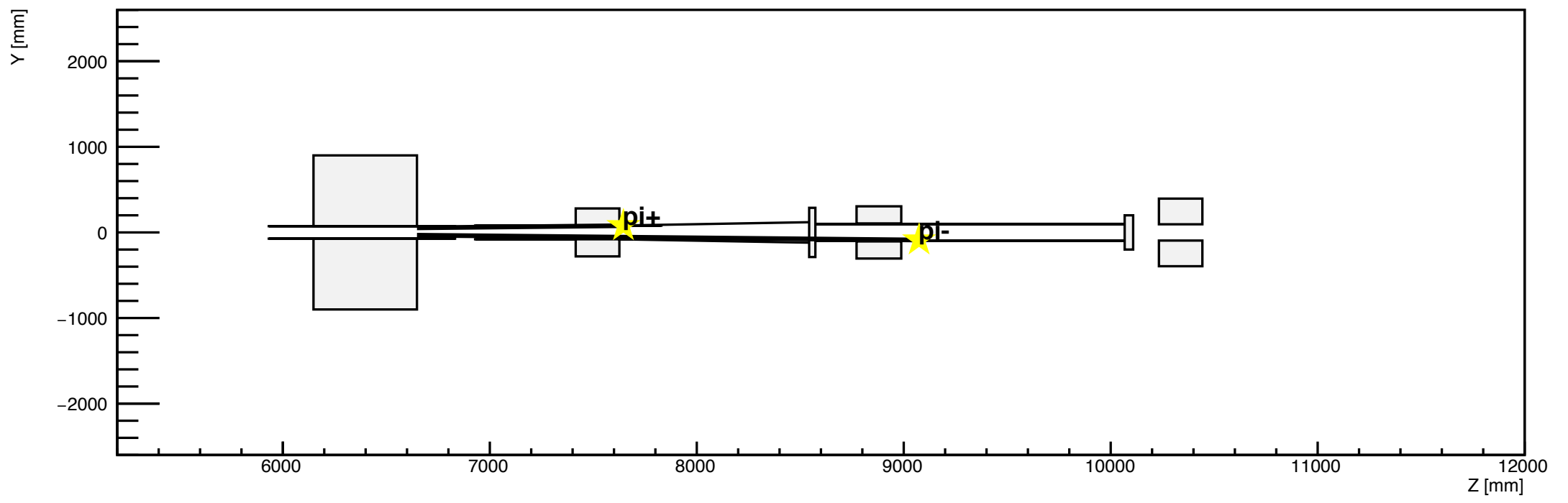

h2

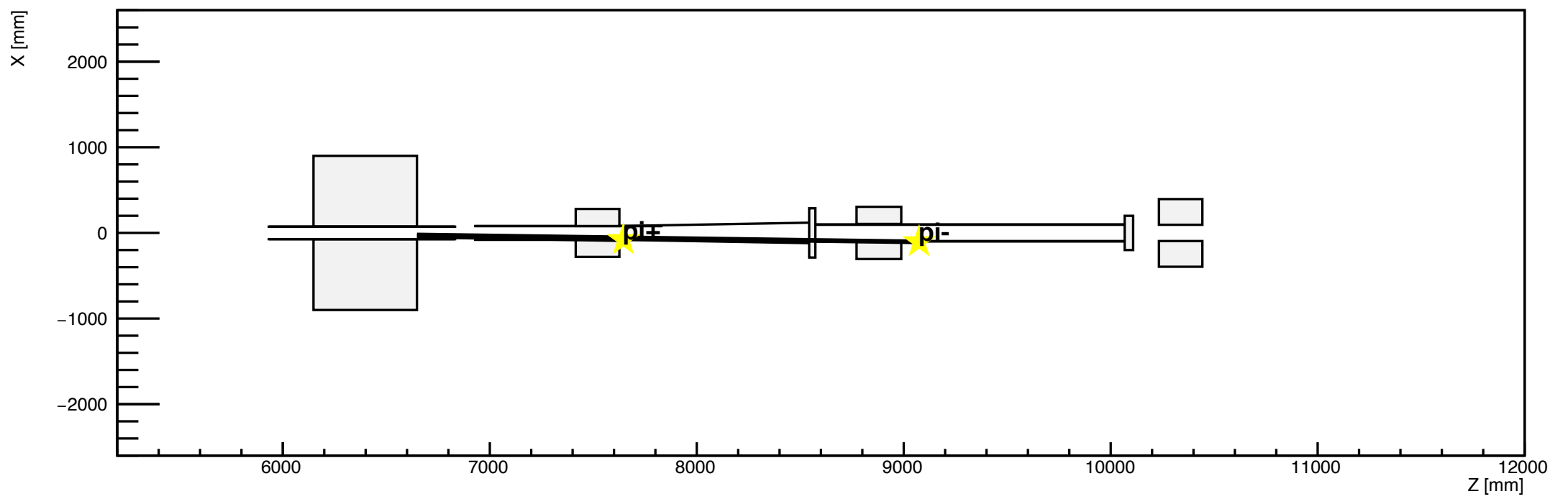

h1

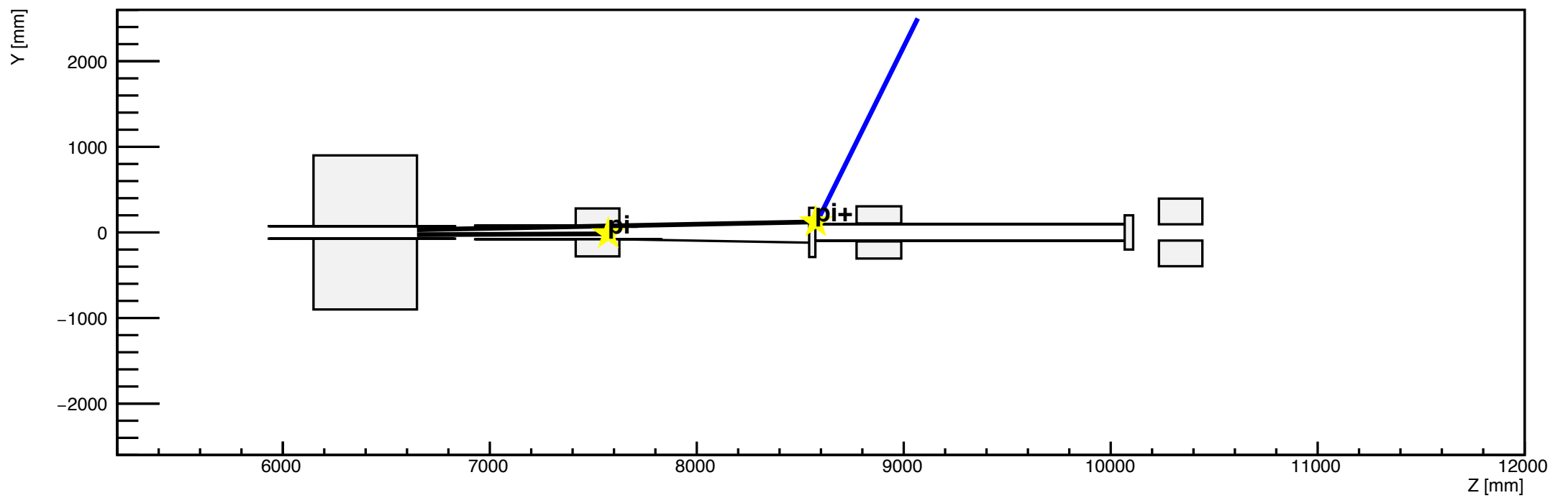

h2

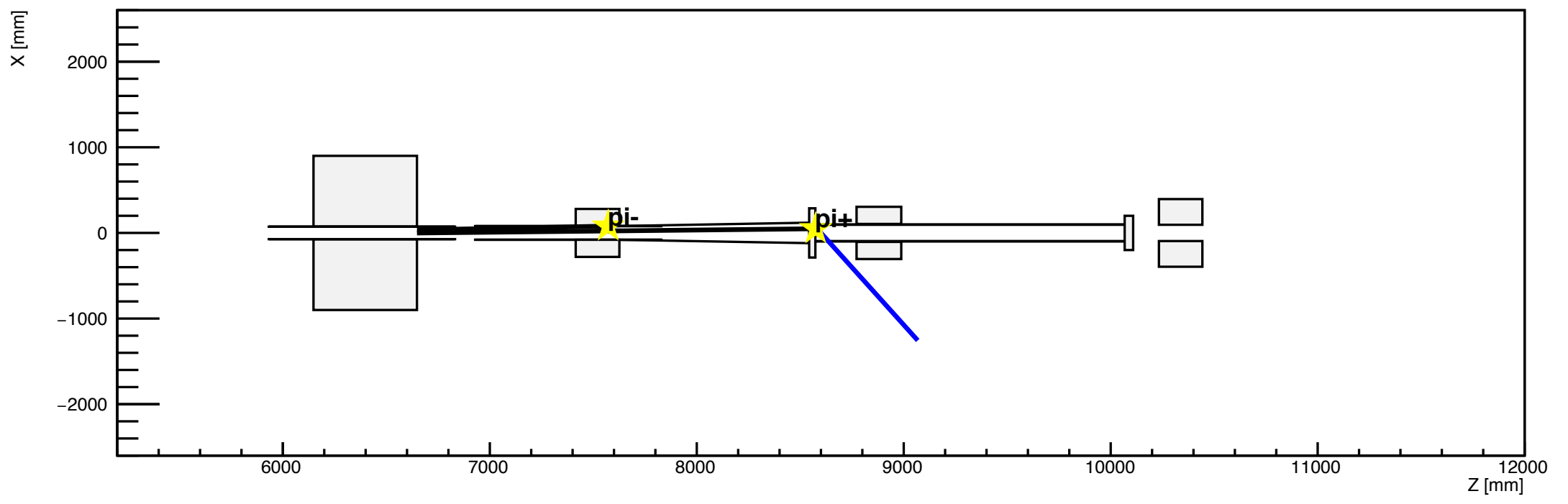

h1

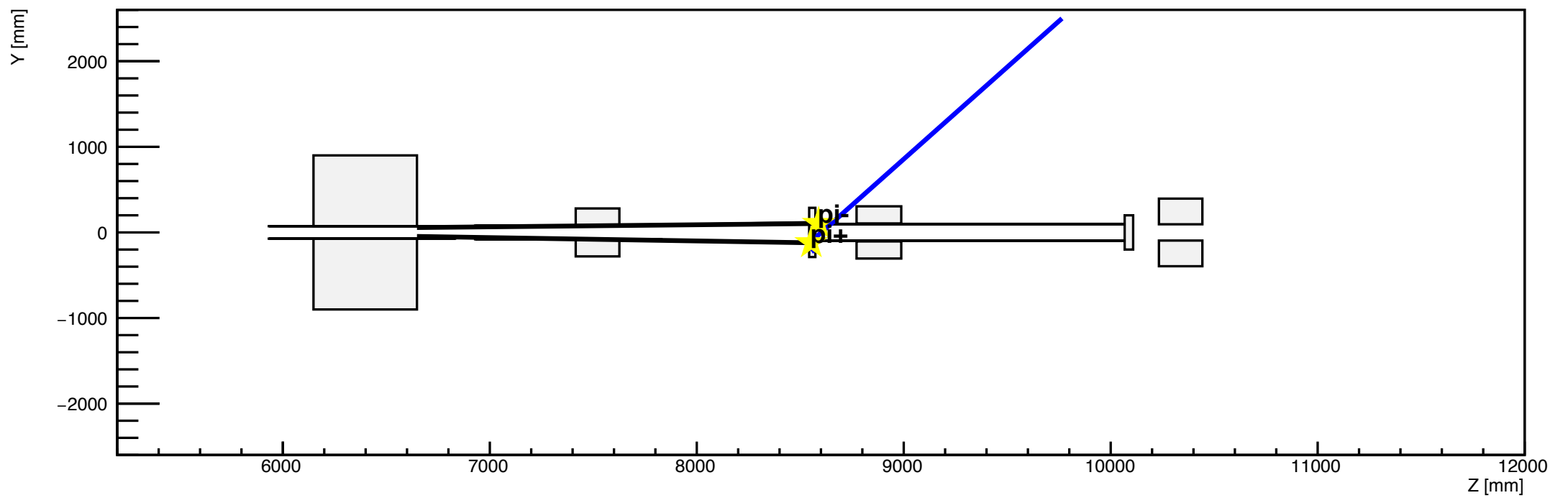

h2

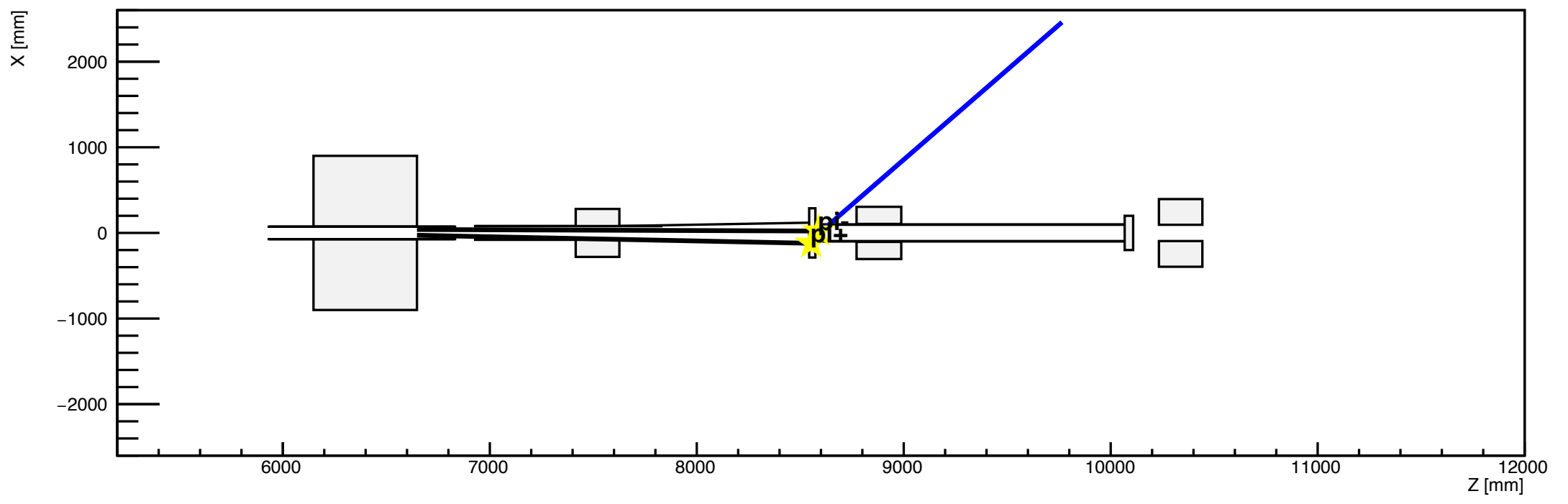

h1

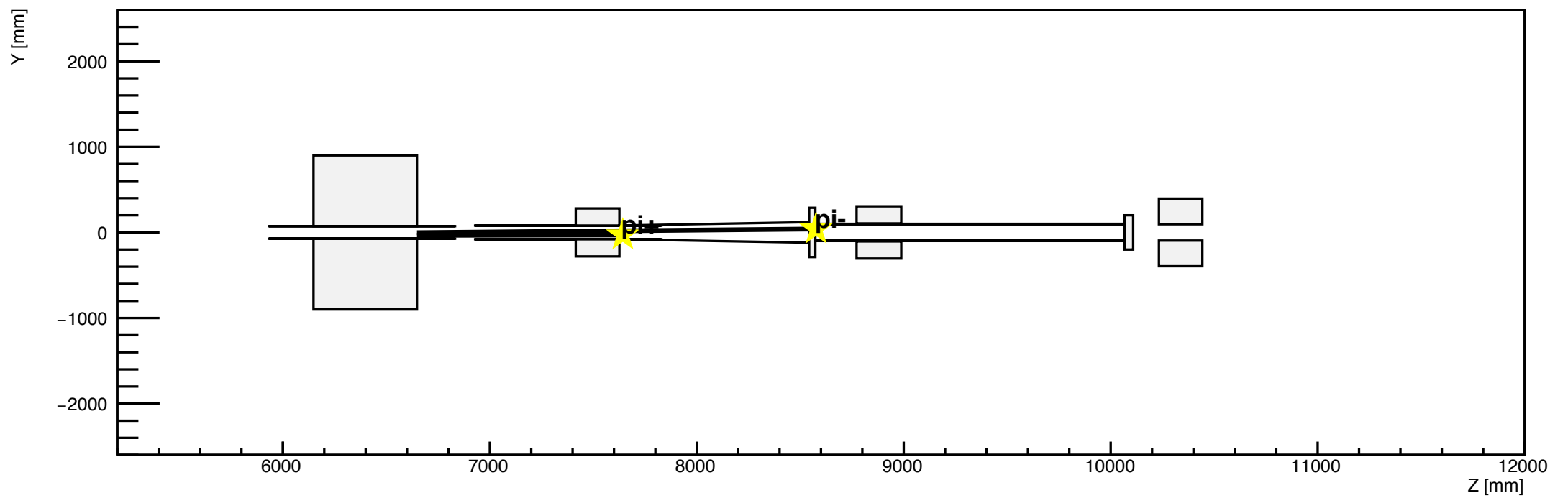

h2

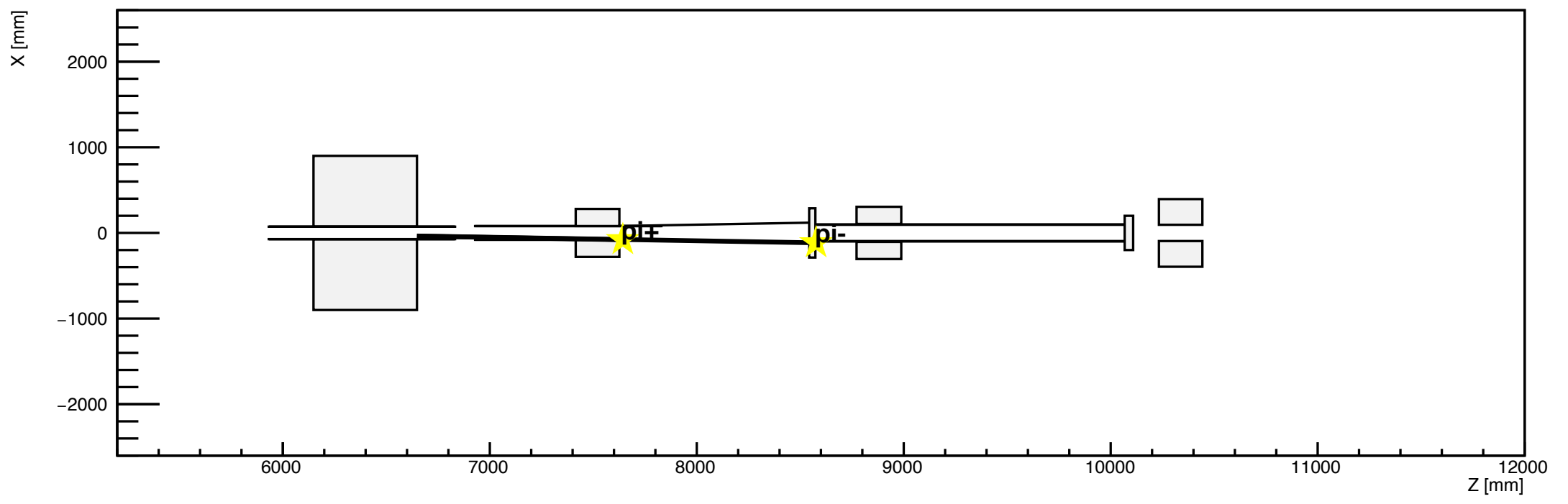

h1

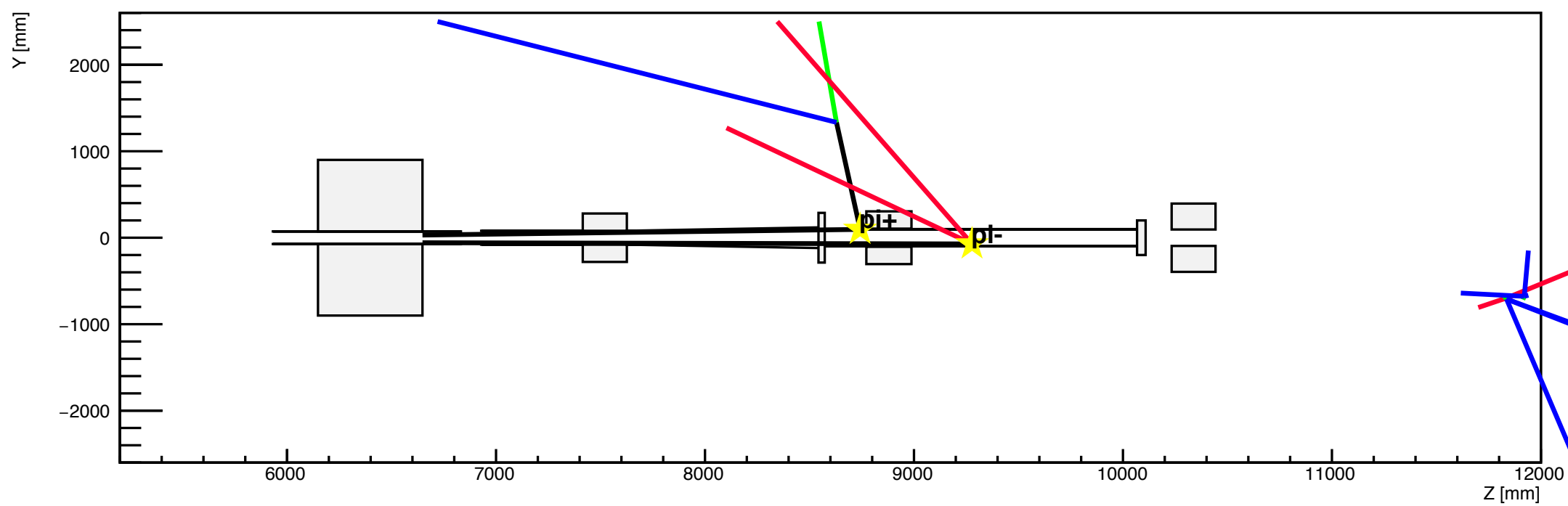

h2

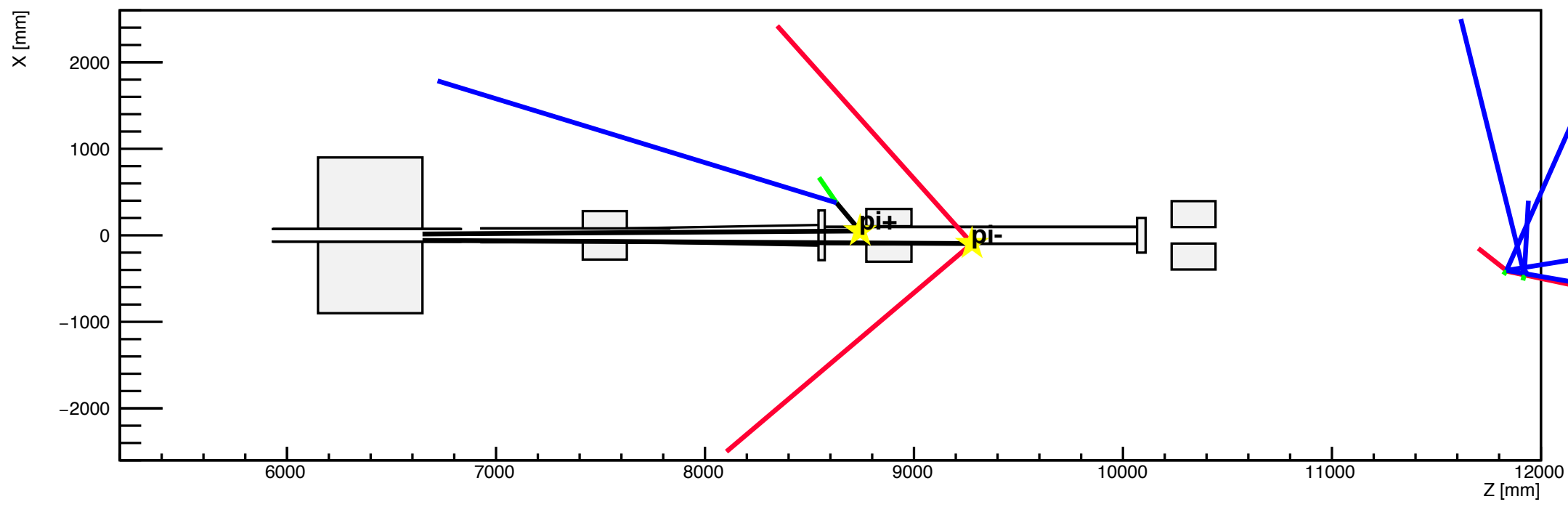

h1

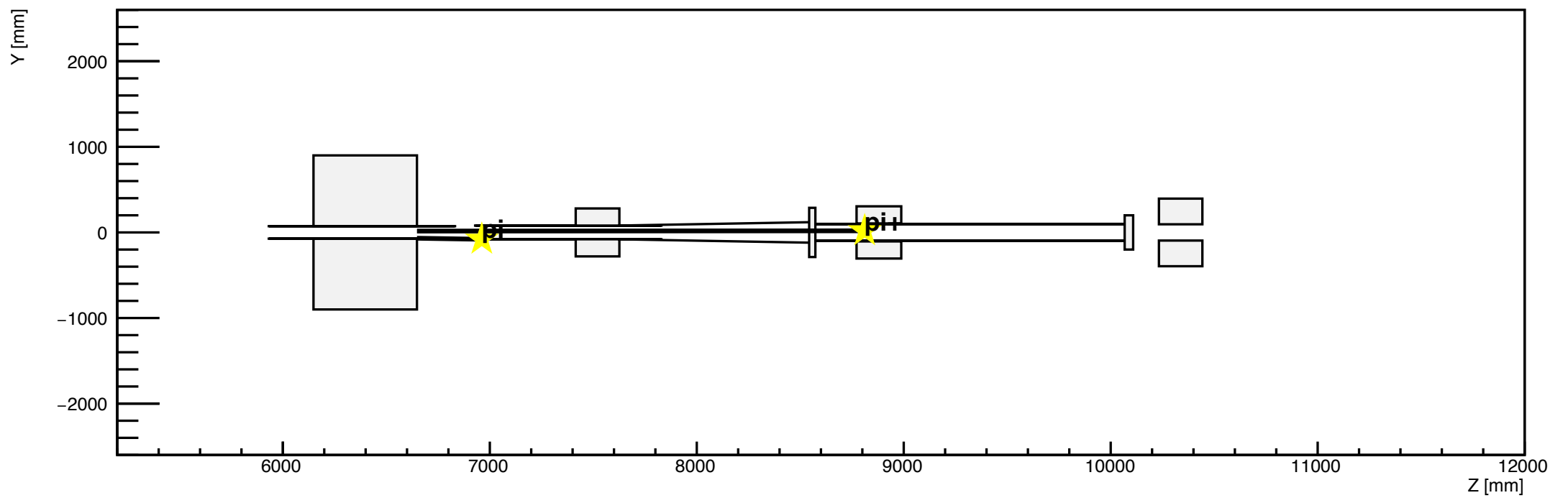

h2

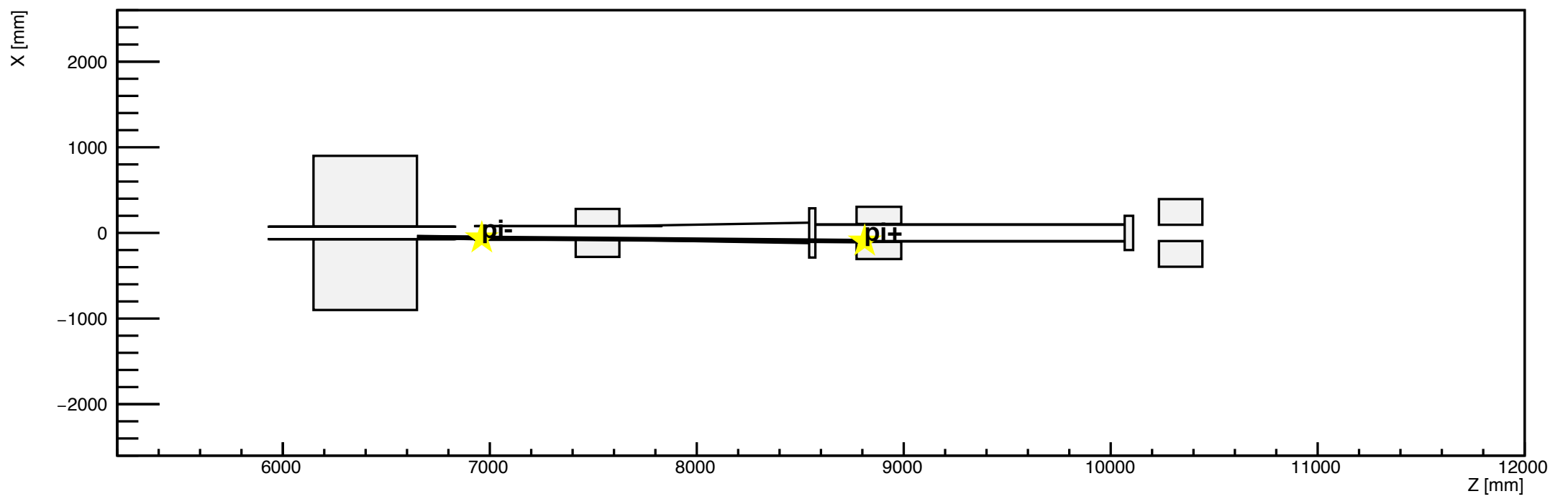

h1

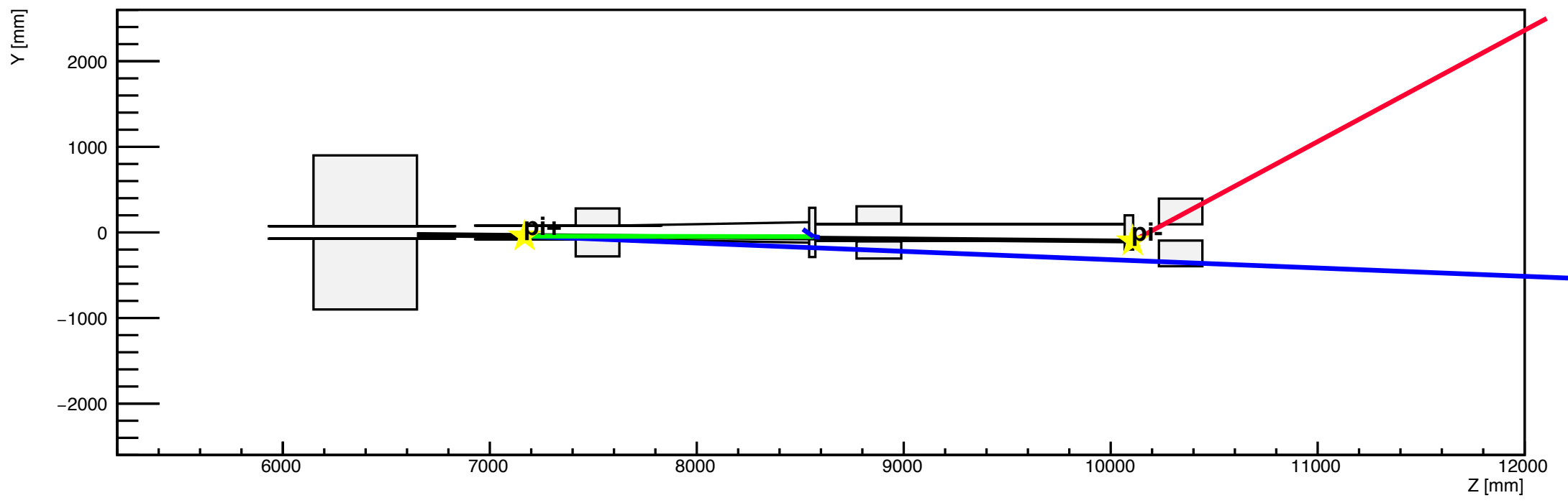

h2

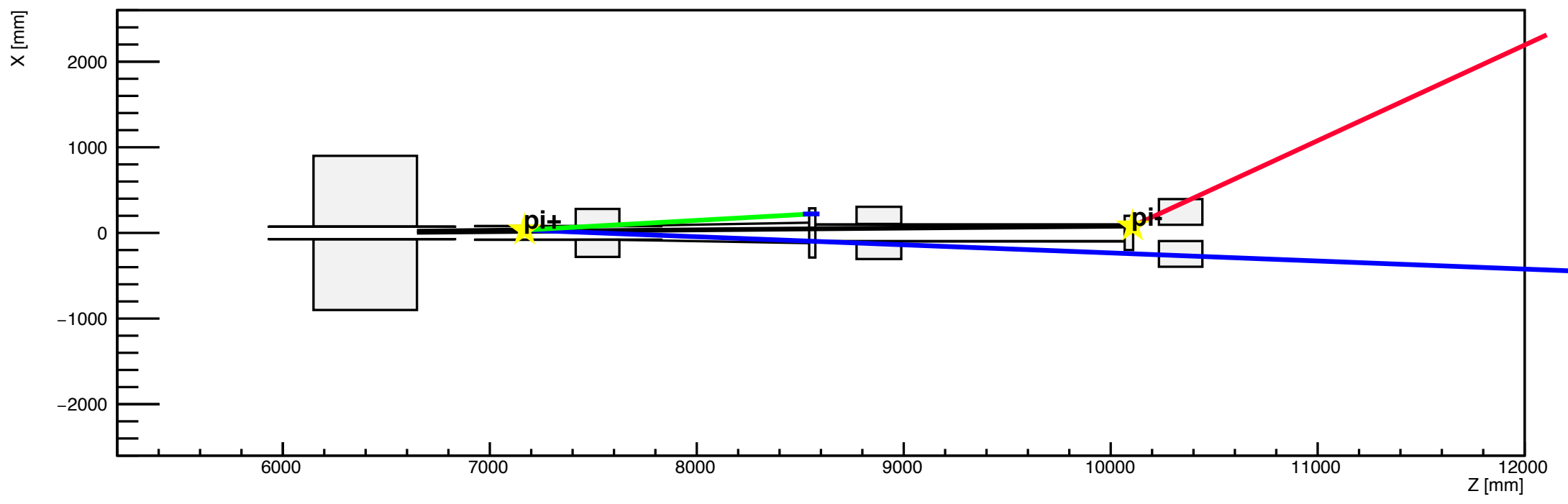

h1

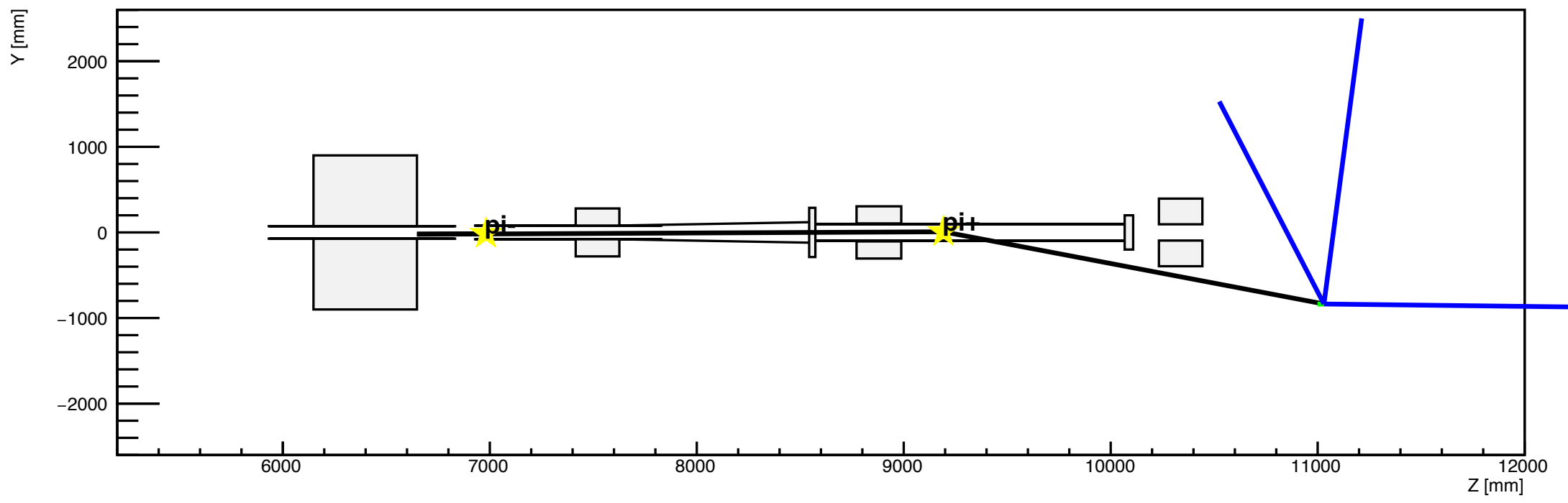

h2

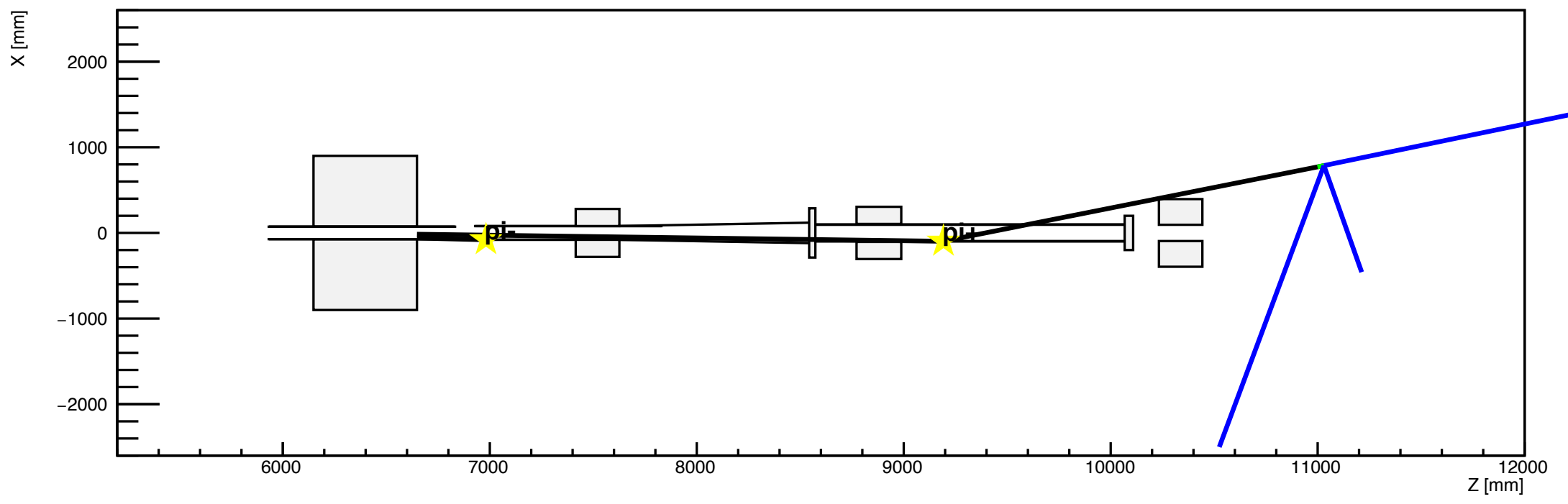

h1

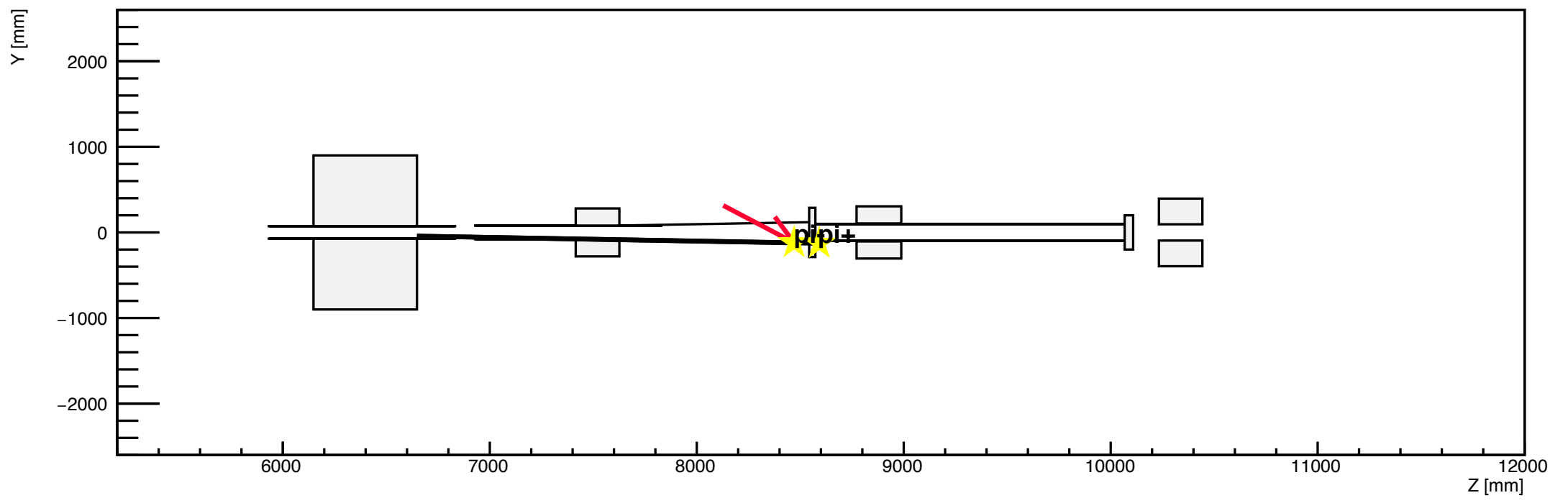

h2

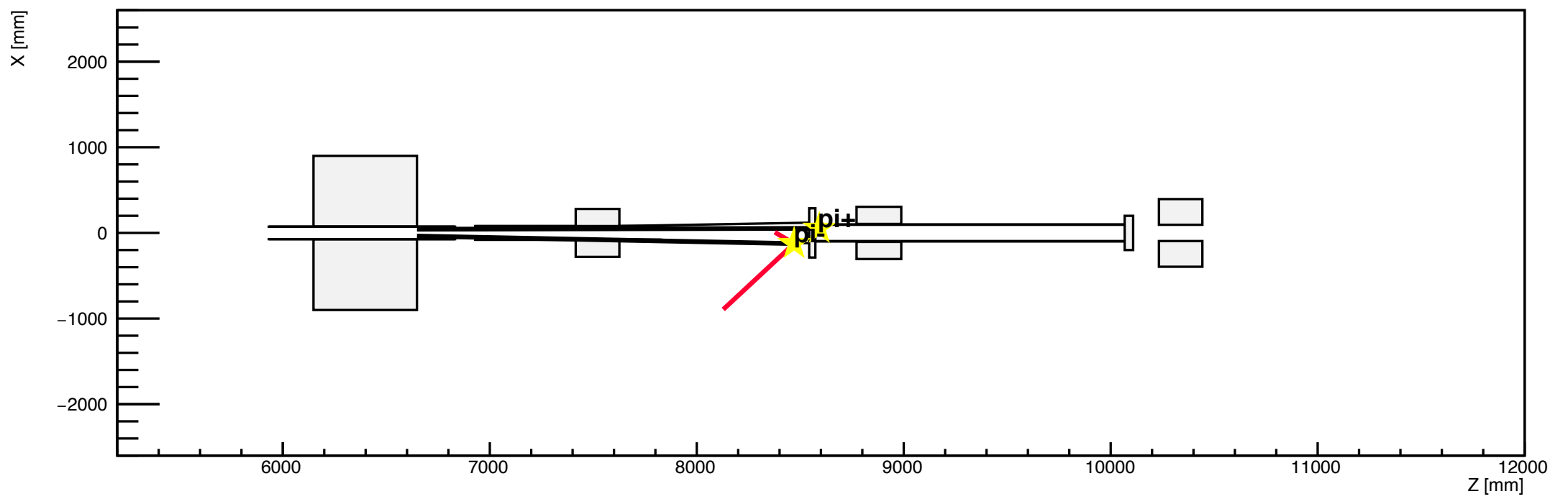

h1

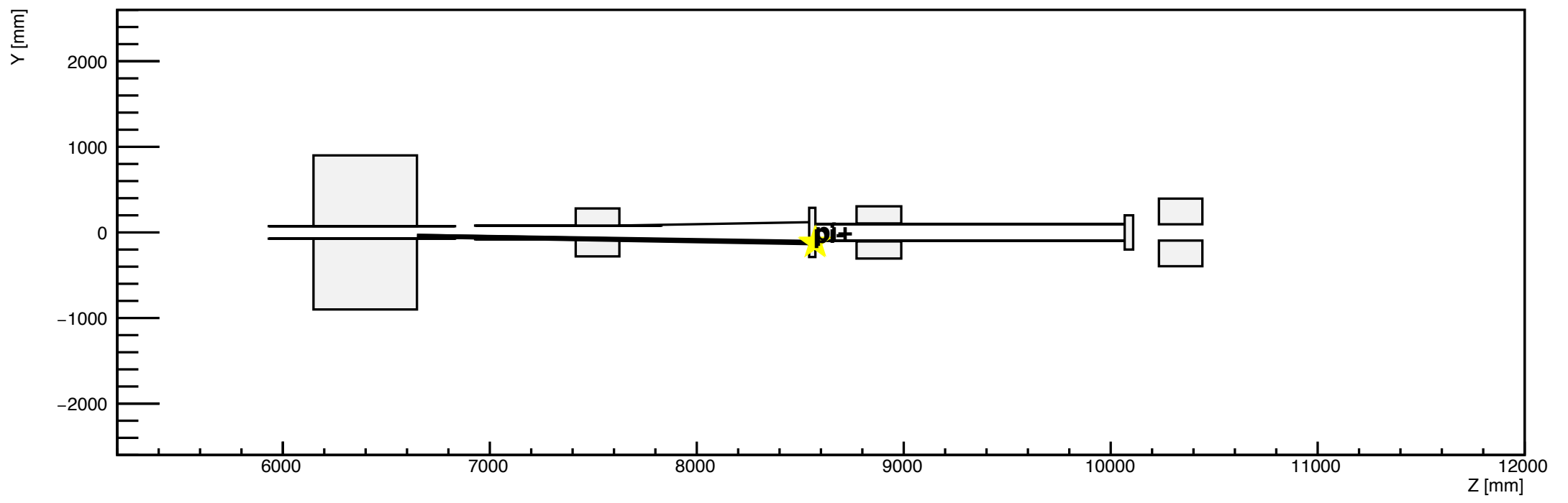

h2

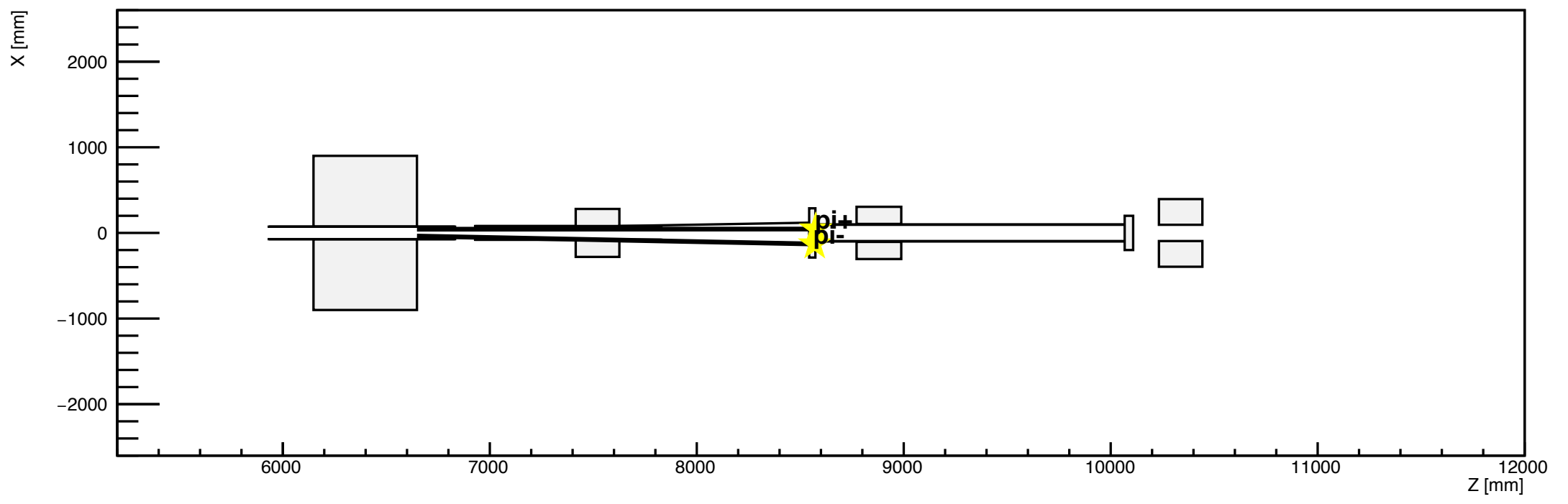

h1

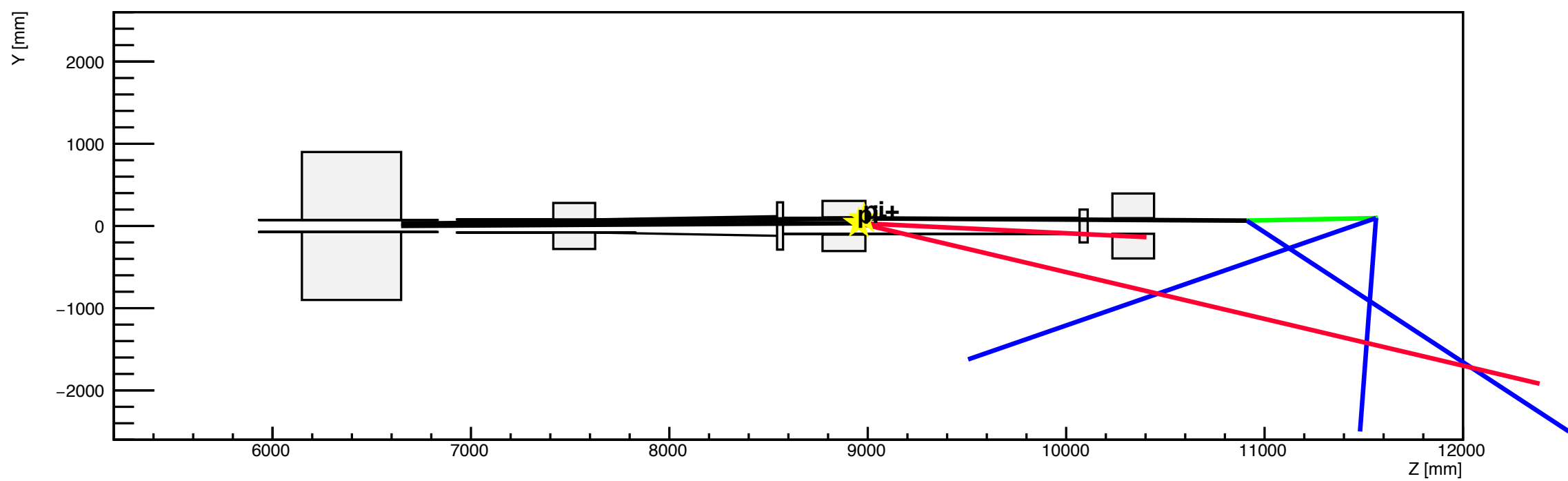

h2

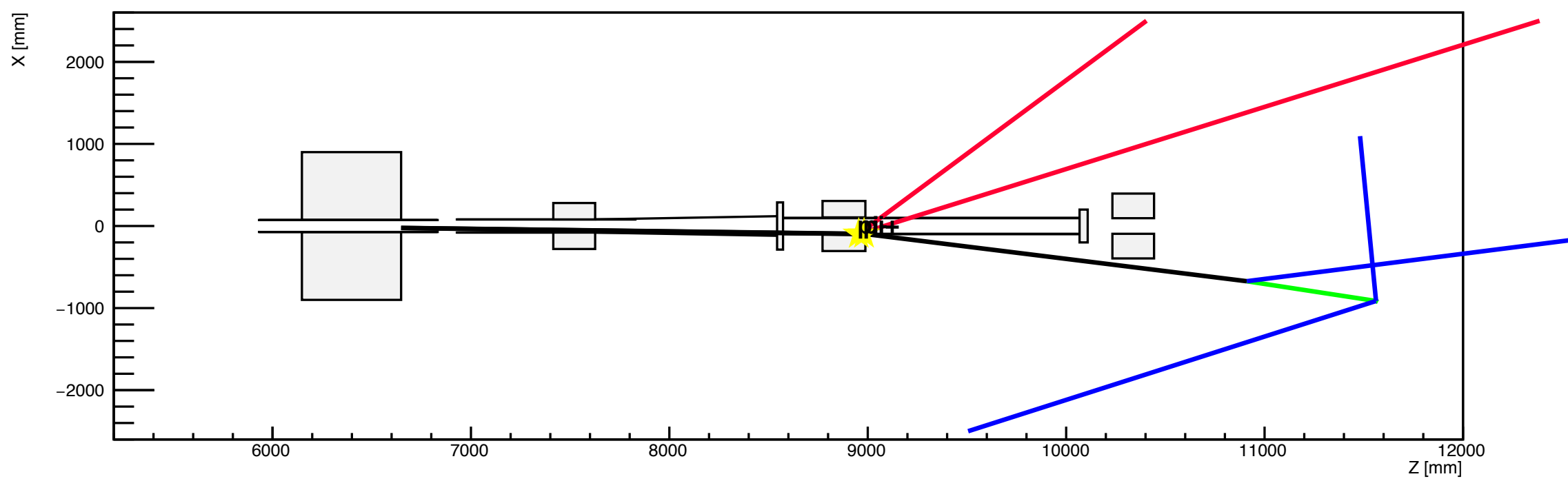

h1

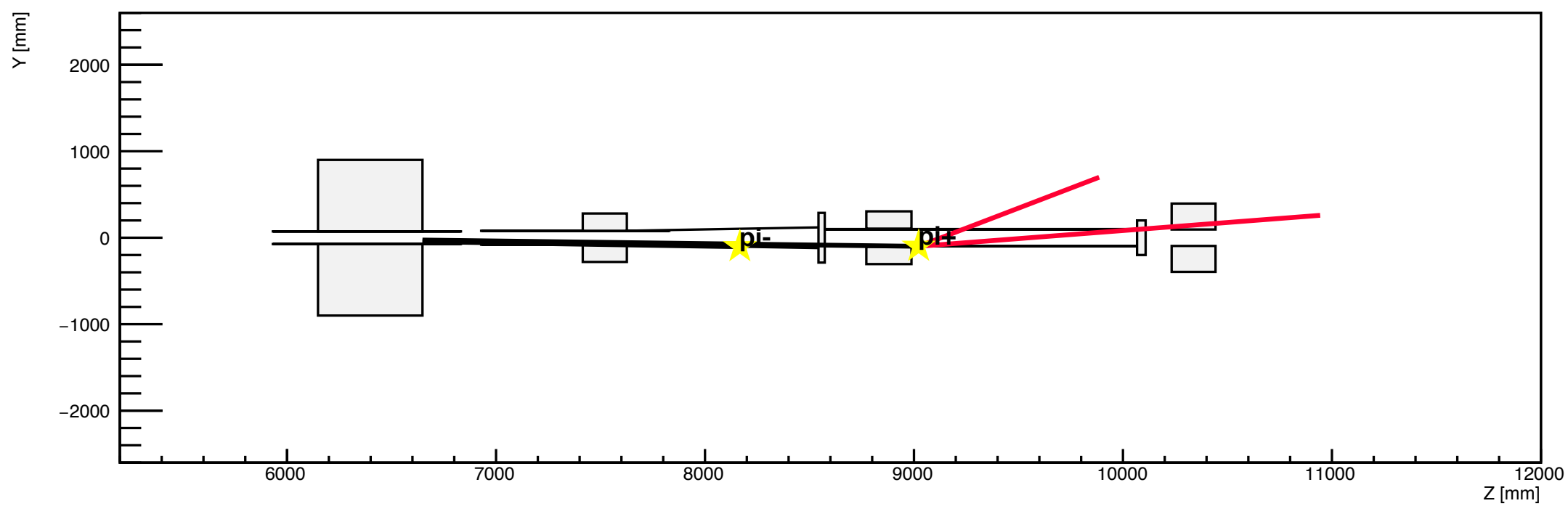

h2

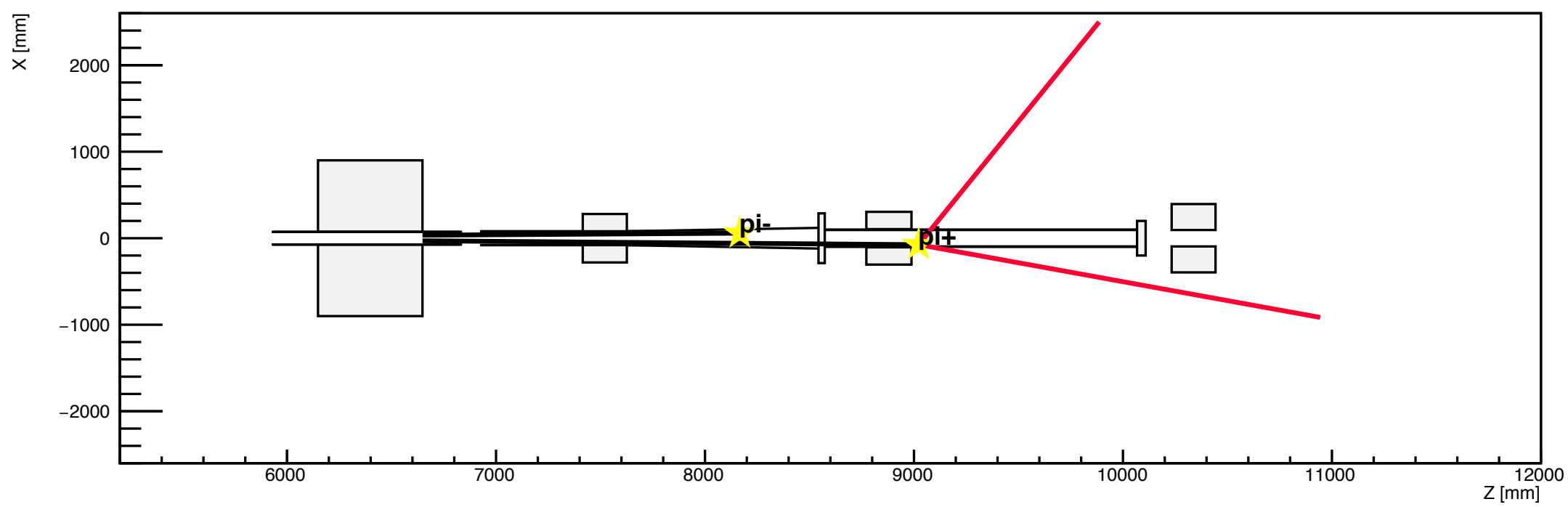

h1

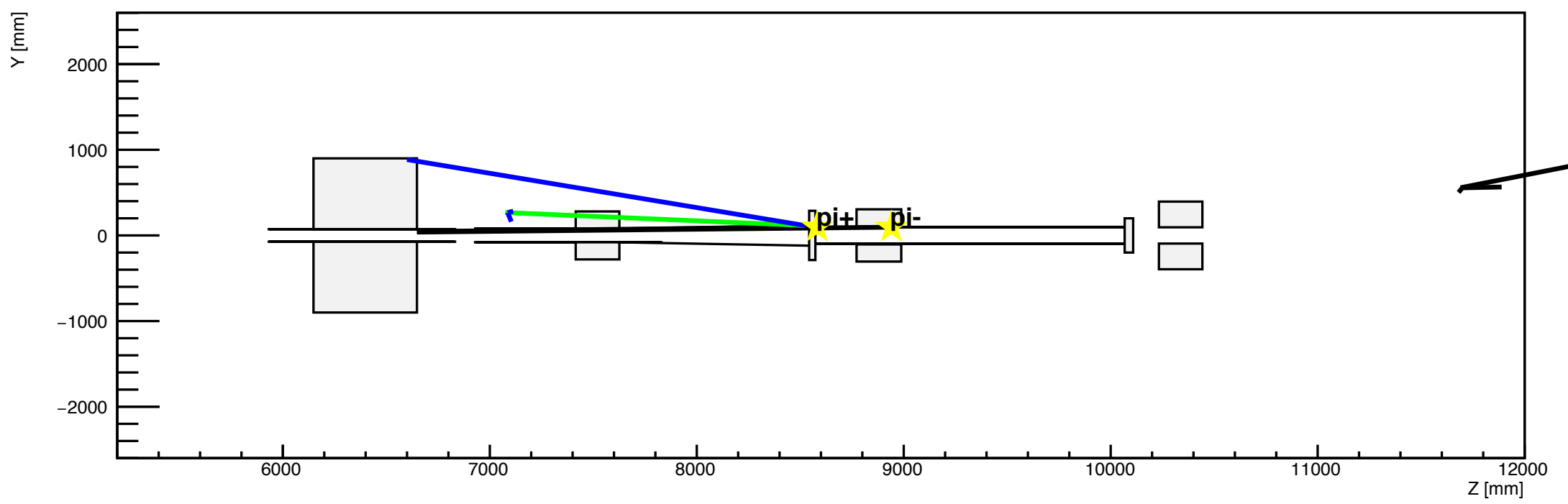

h2

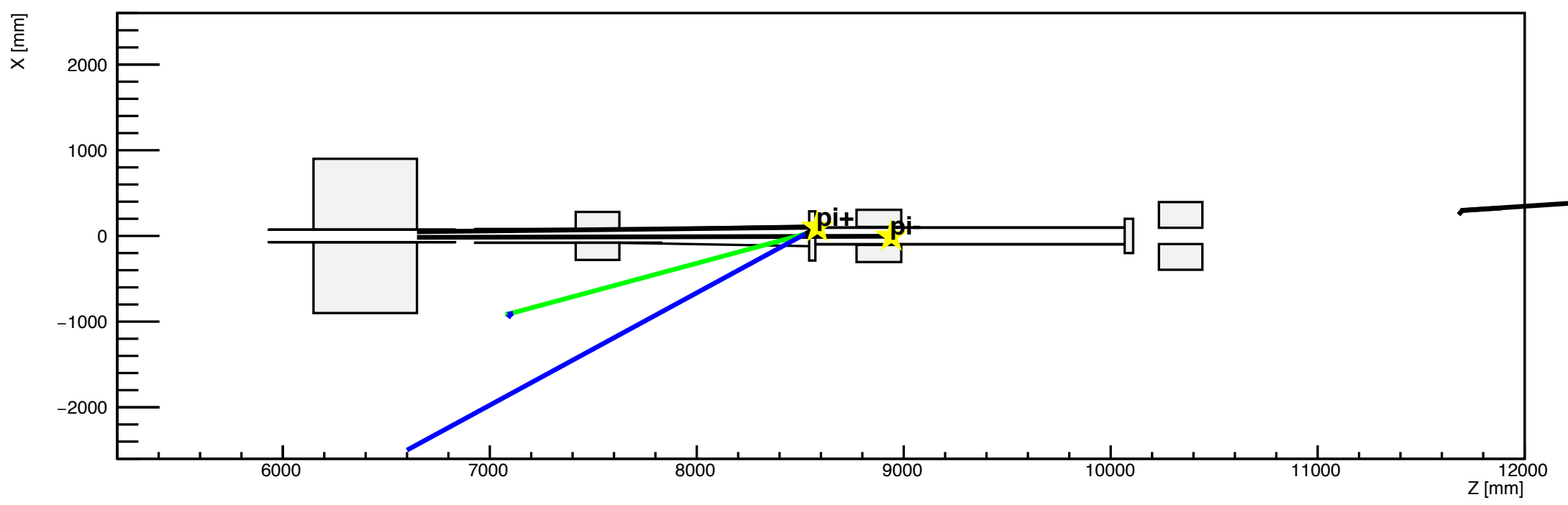

h1

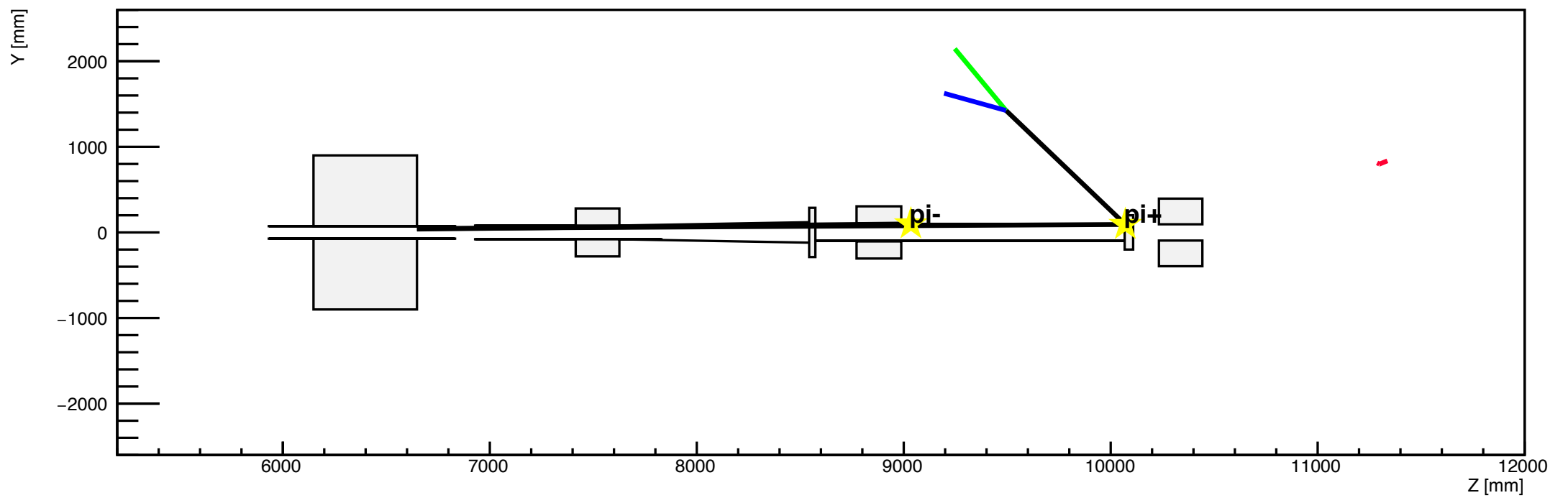

h2

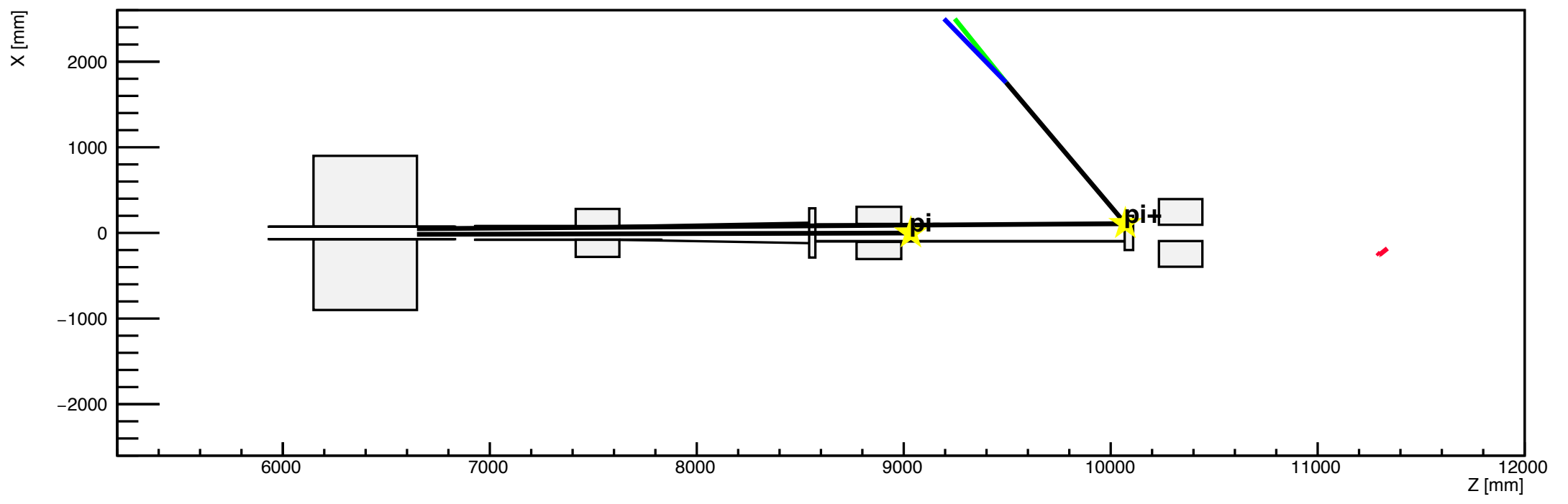

h1

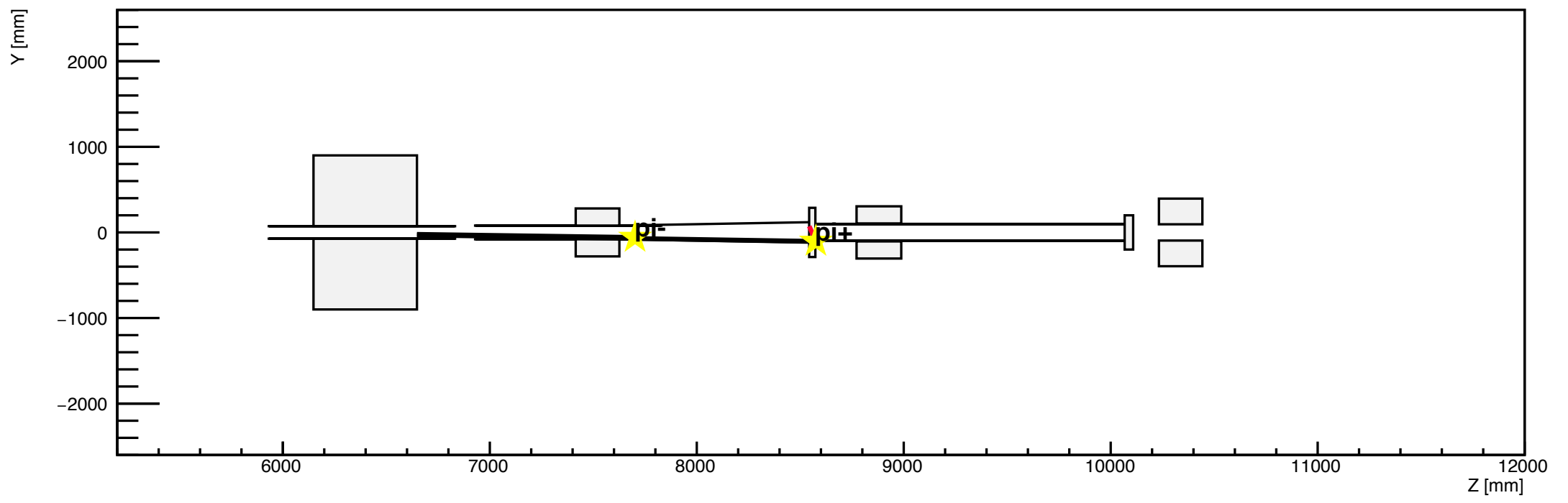

h2

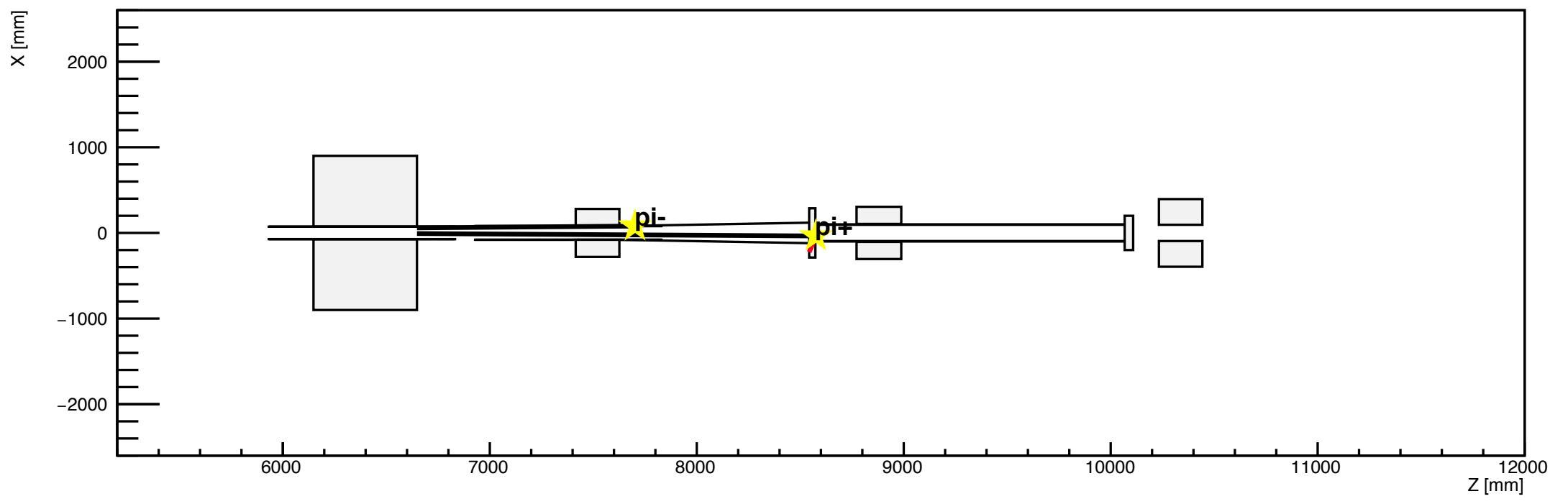

h1

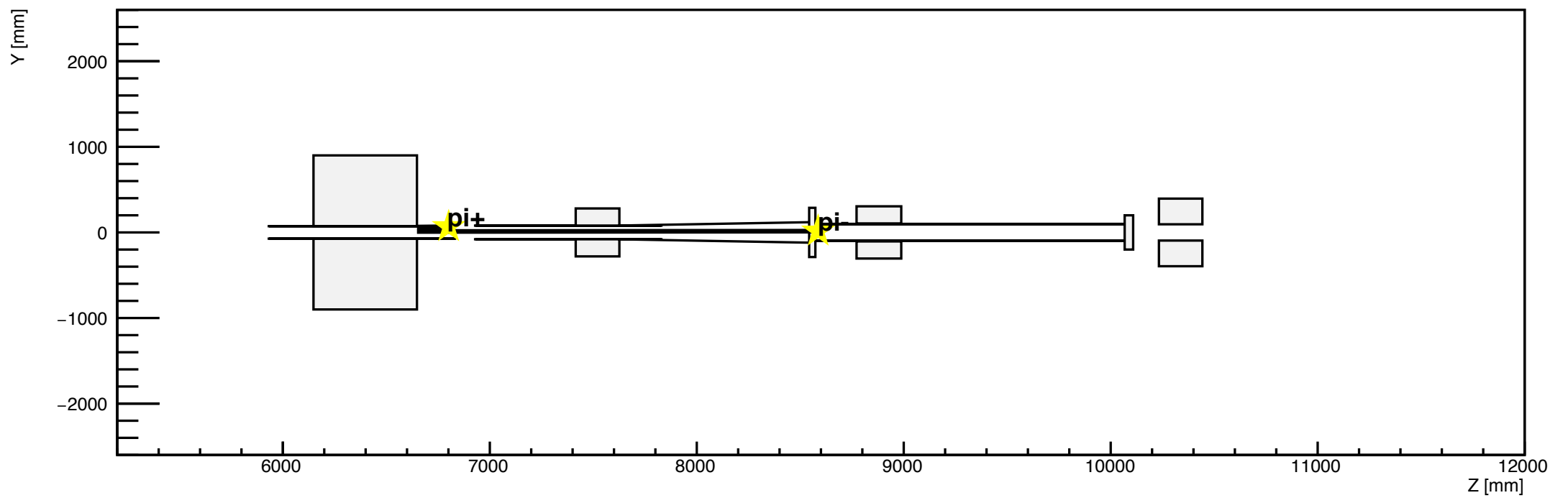

h2

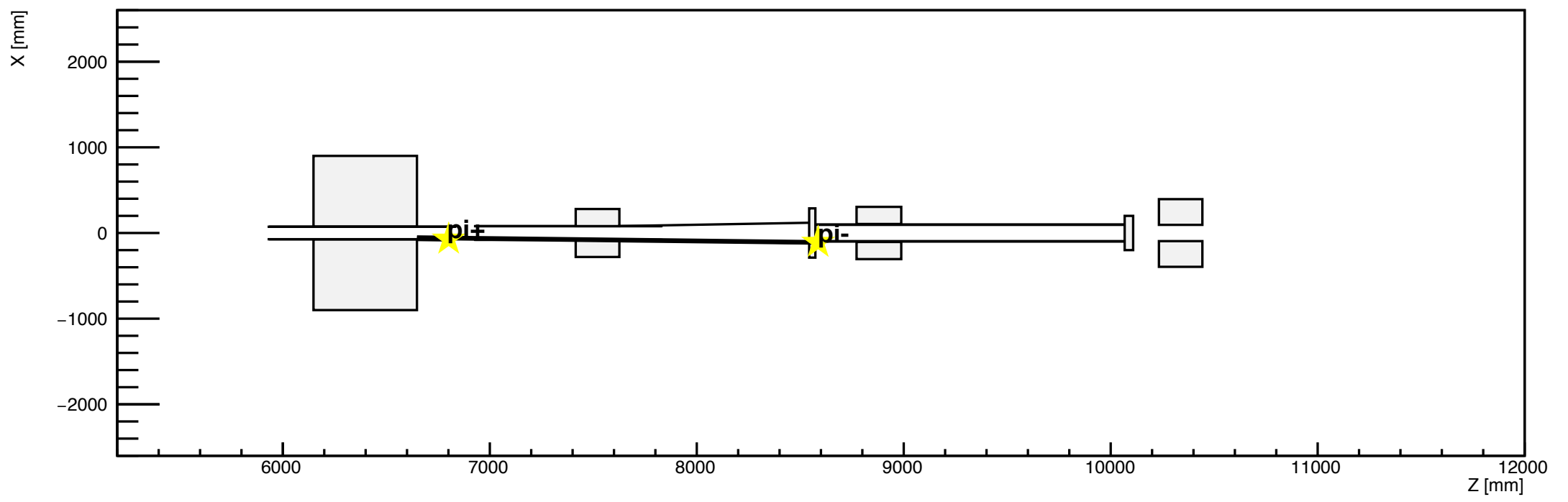

h1

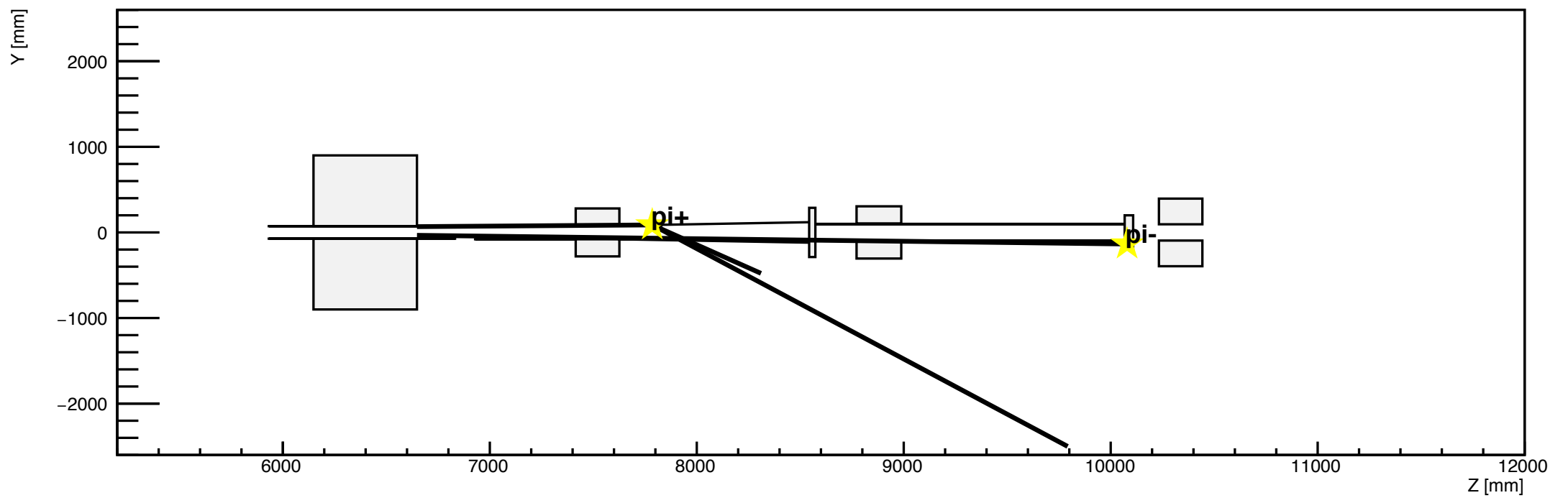

h2

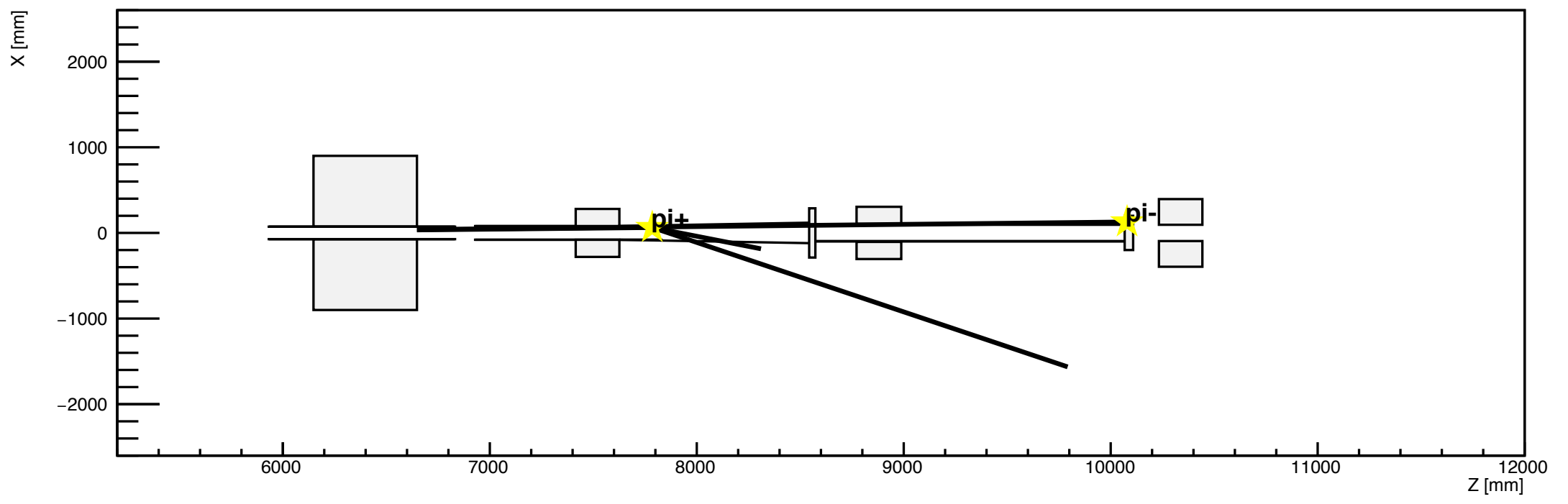

h1

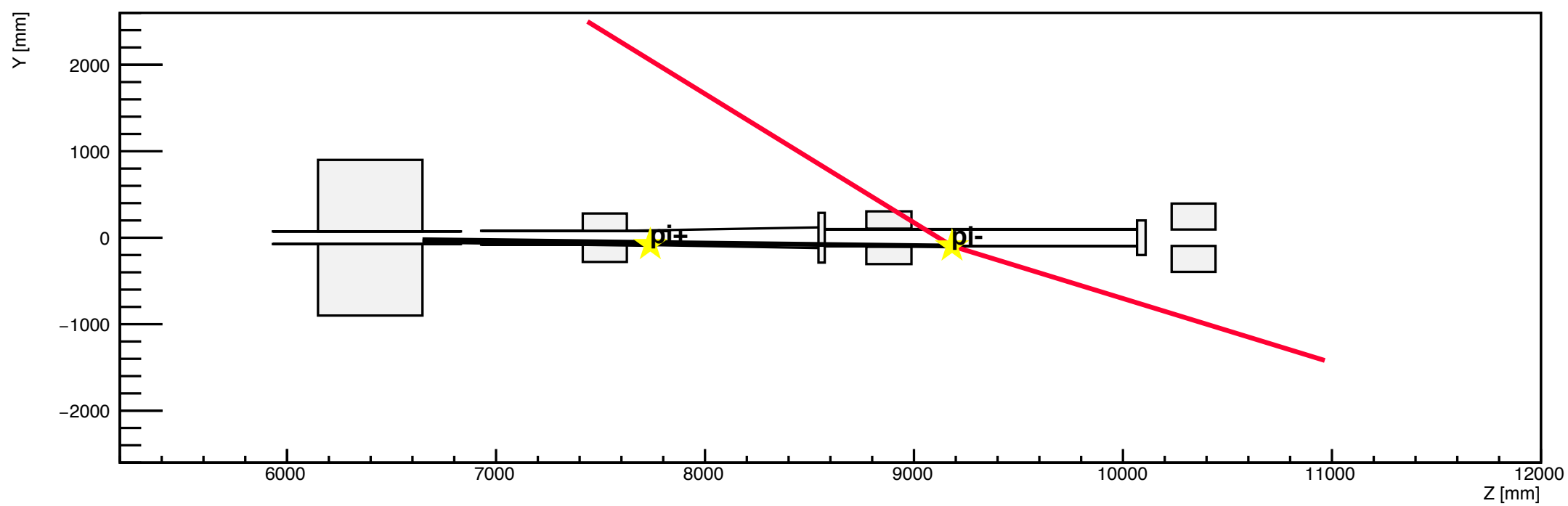

h2

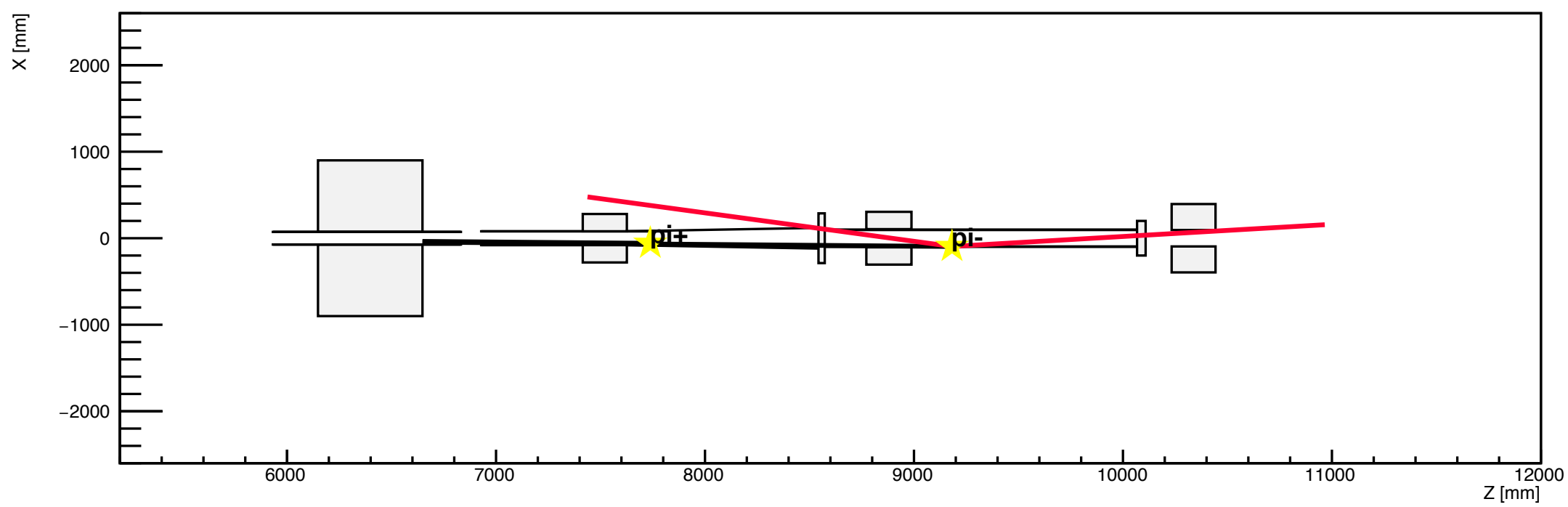

h1

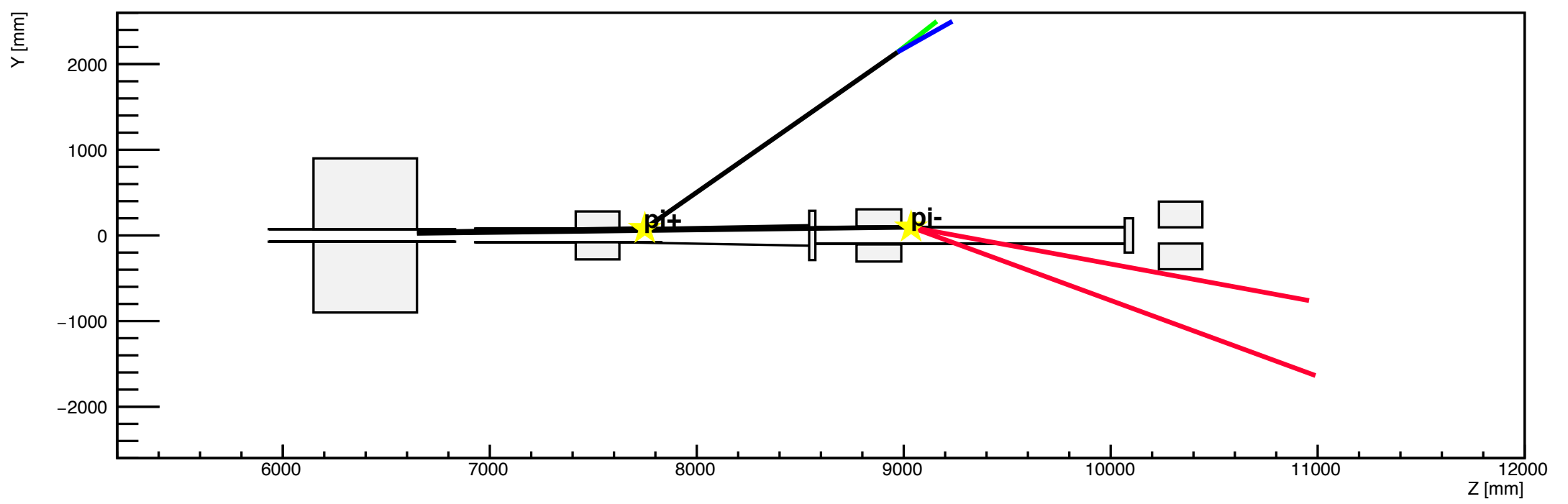

h2

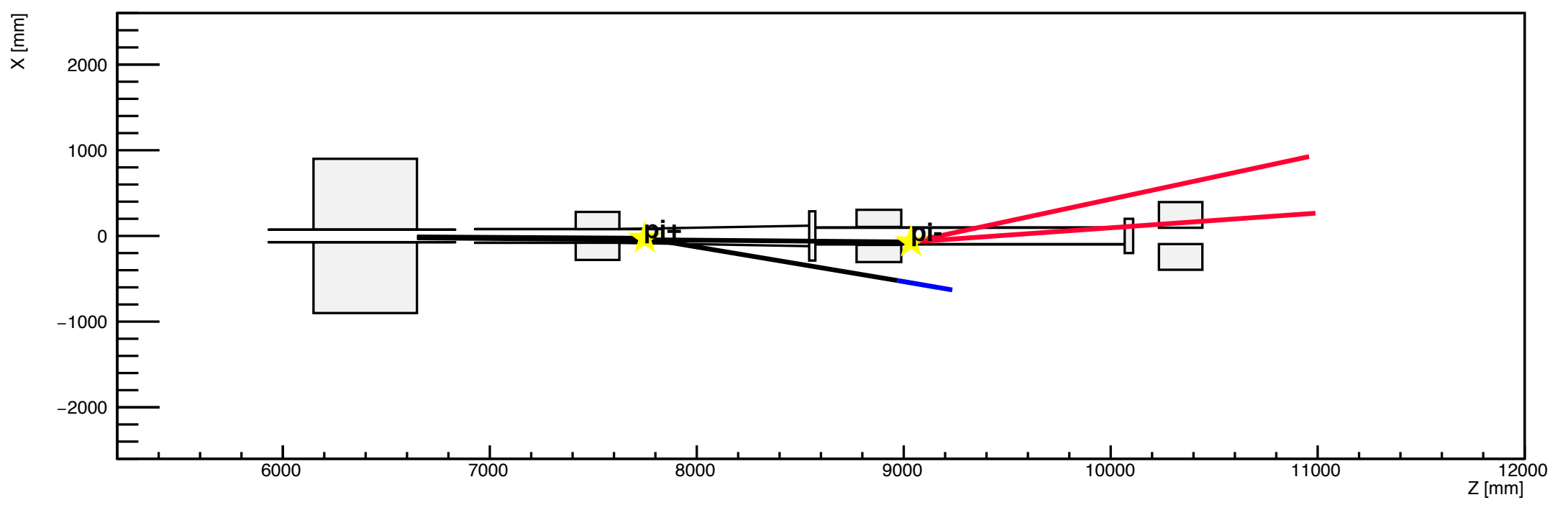

h1

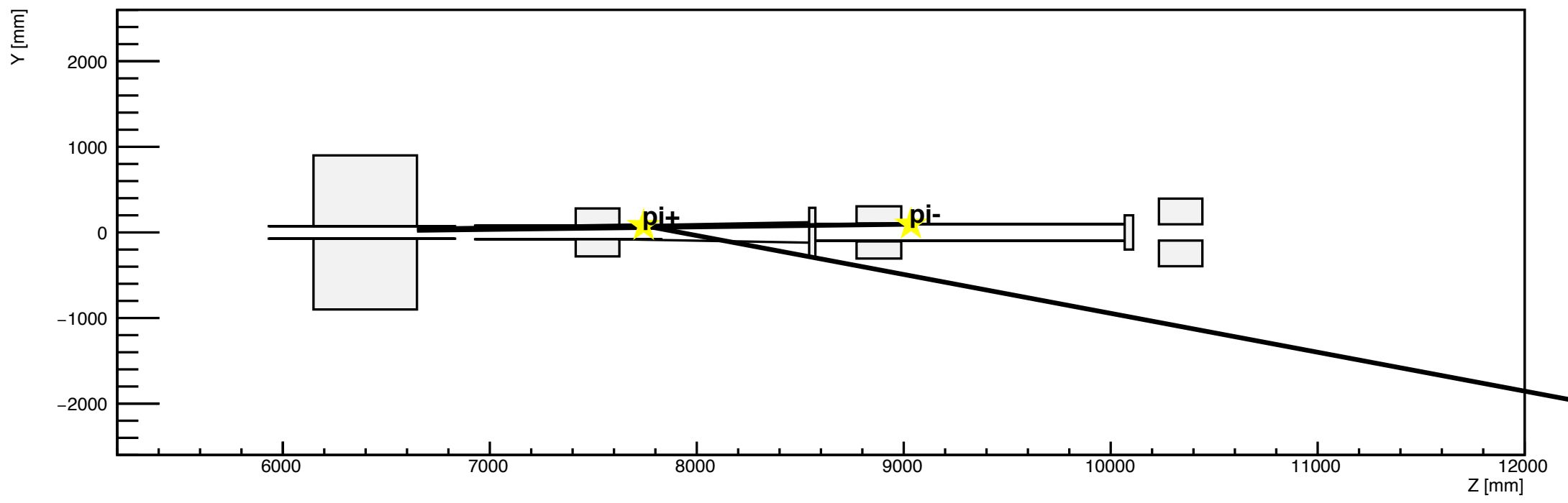

h2

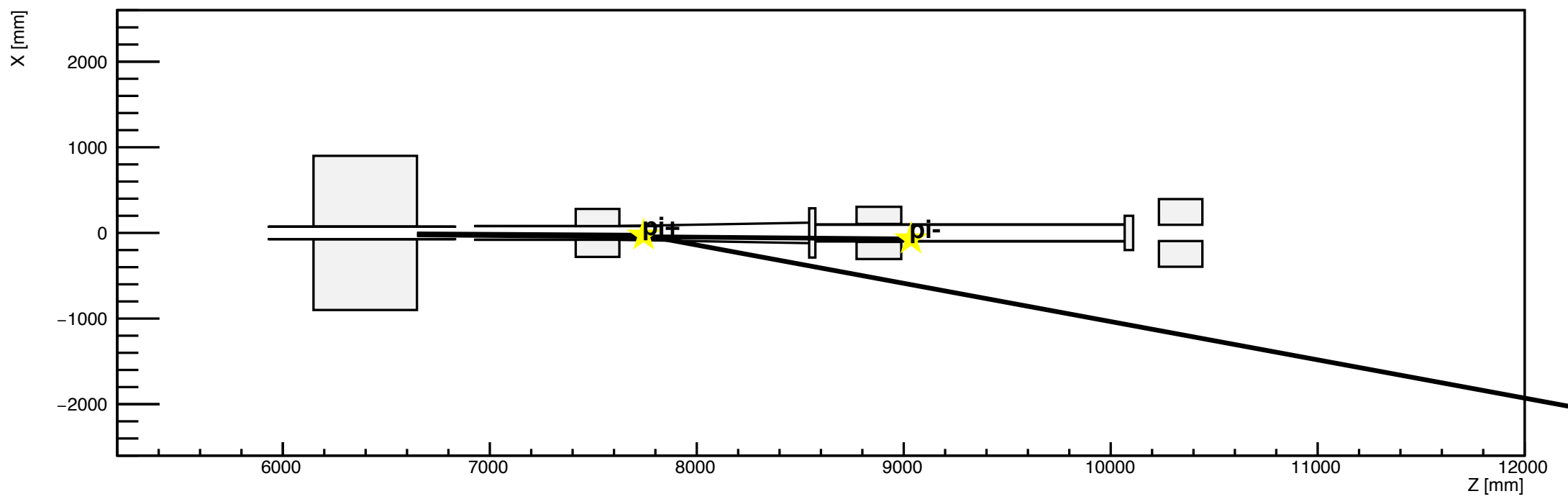

h1

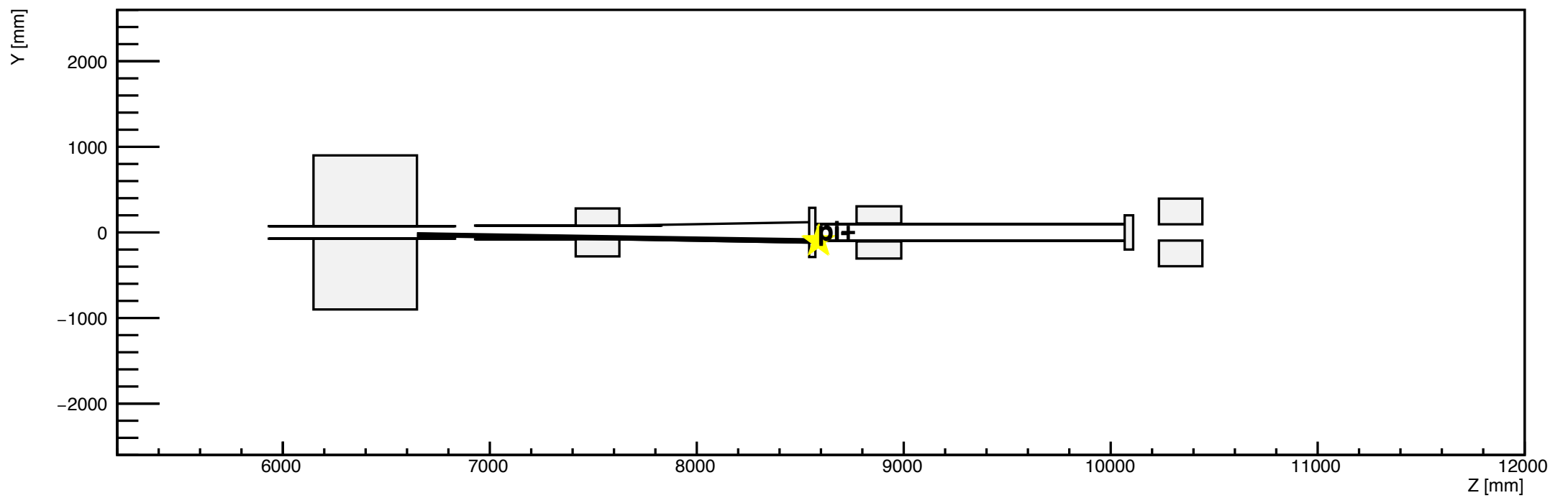

h2

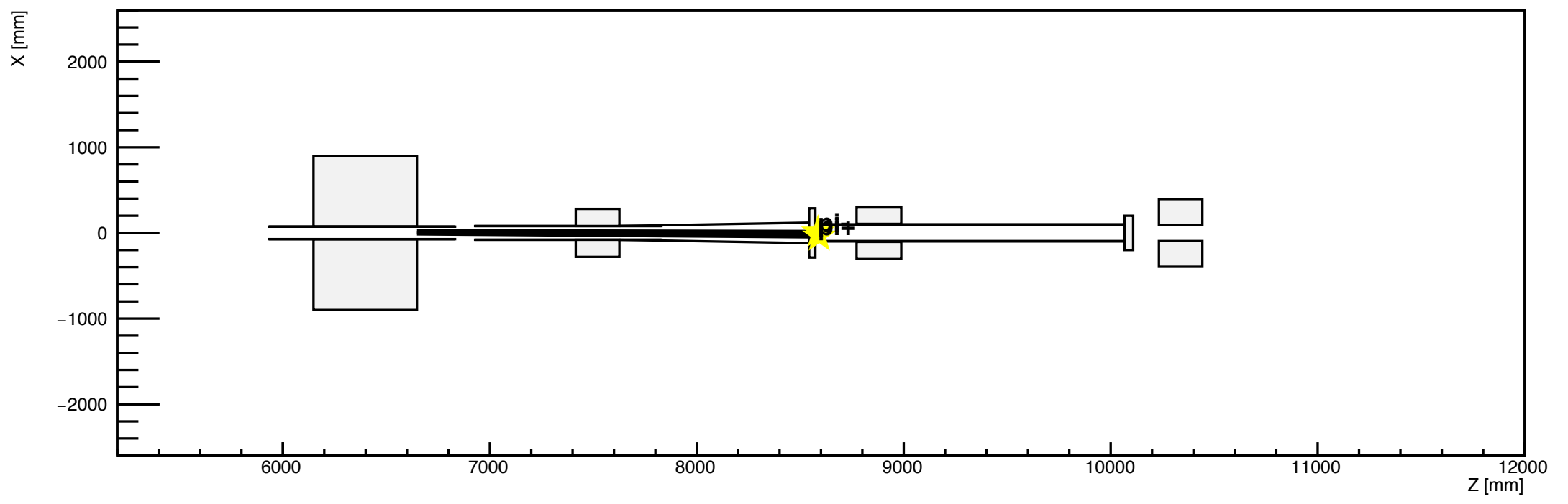

h1

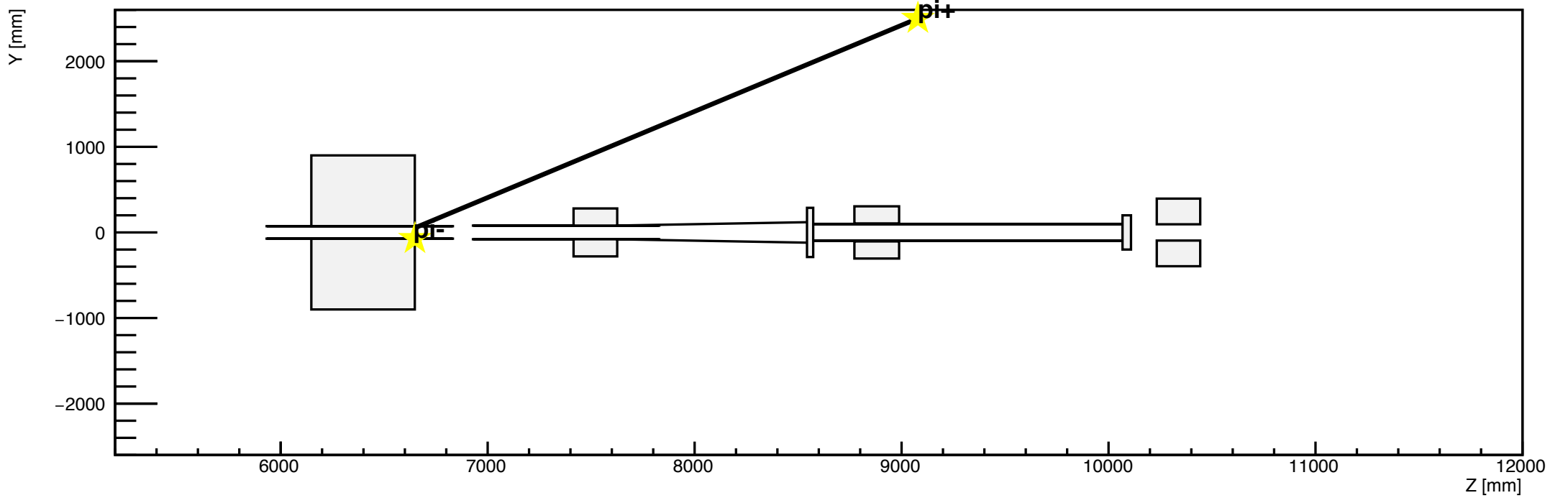

h2

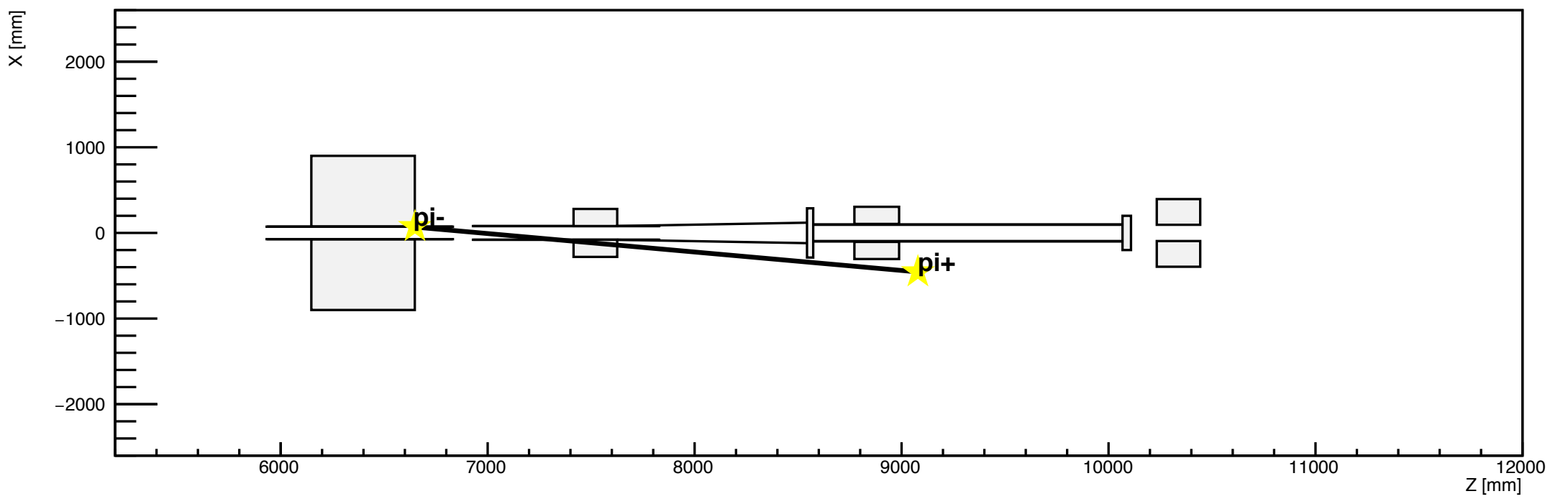

h1

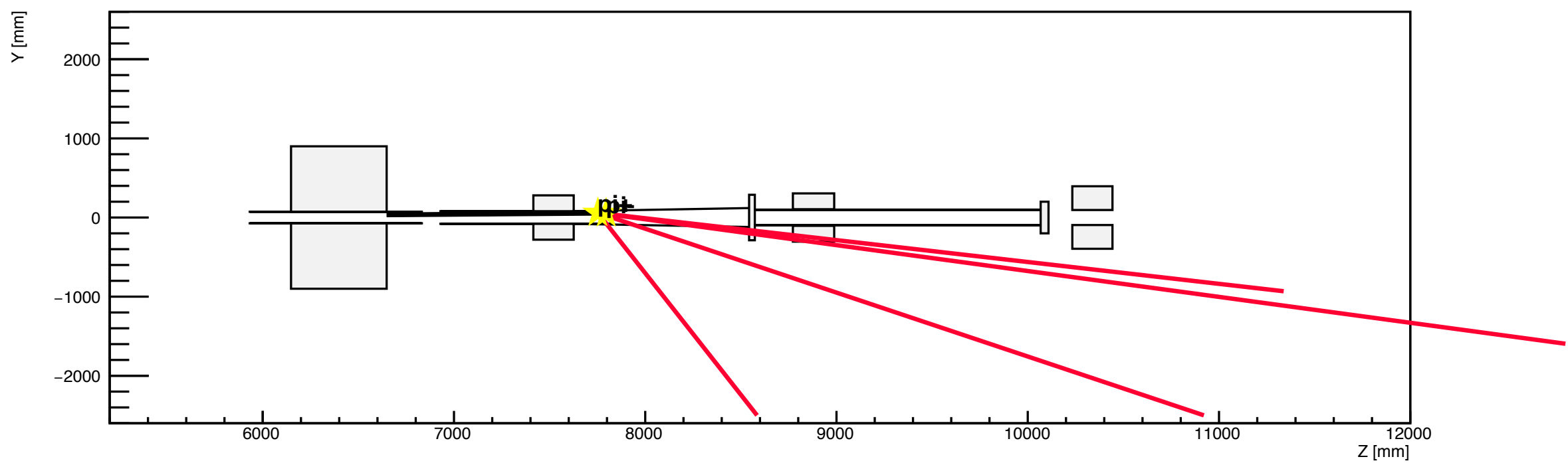

h2

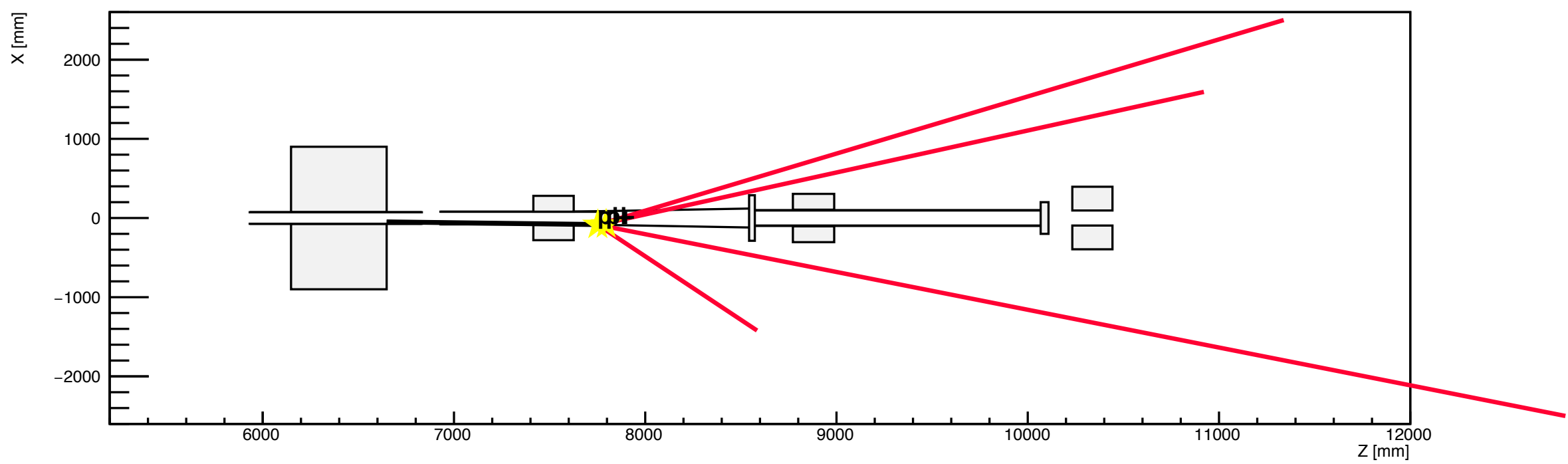

h1

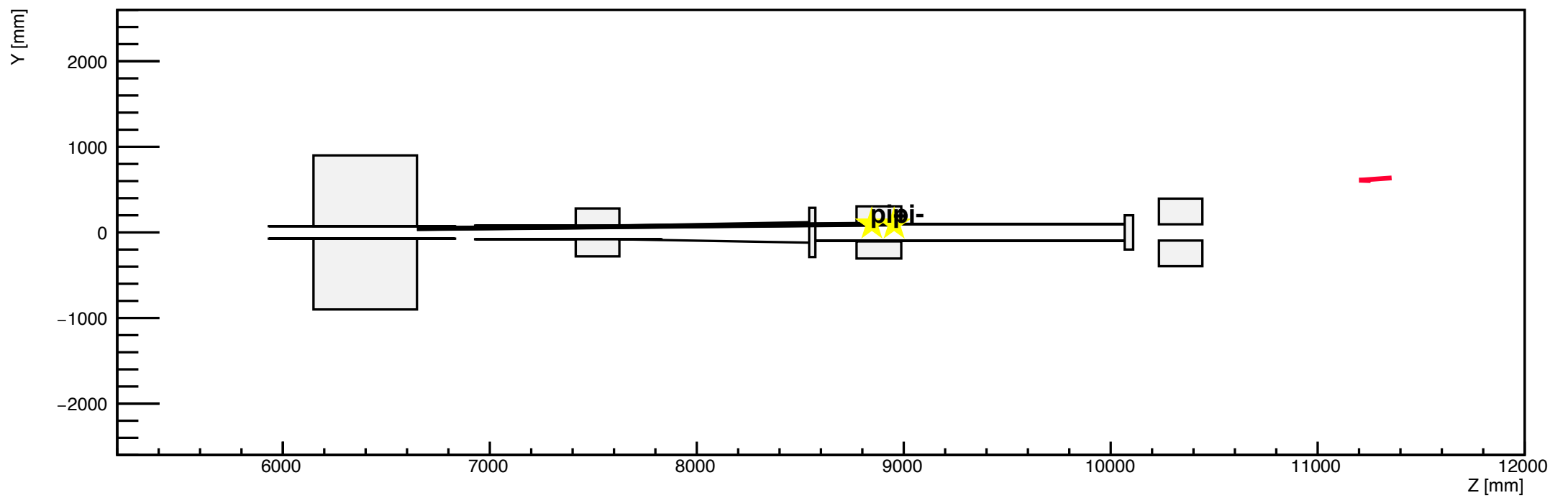

h2

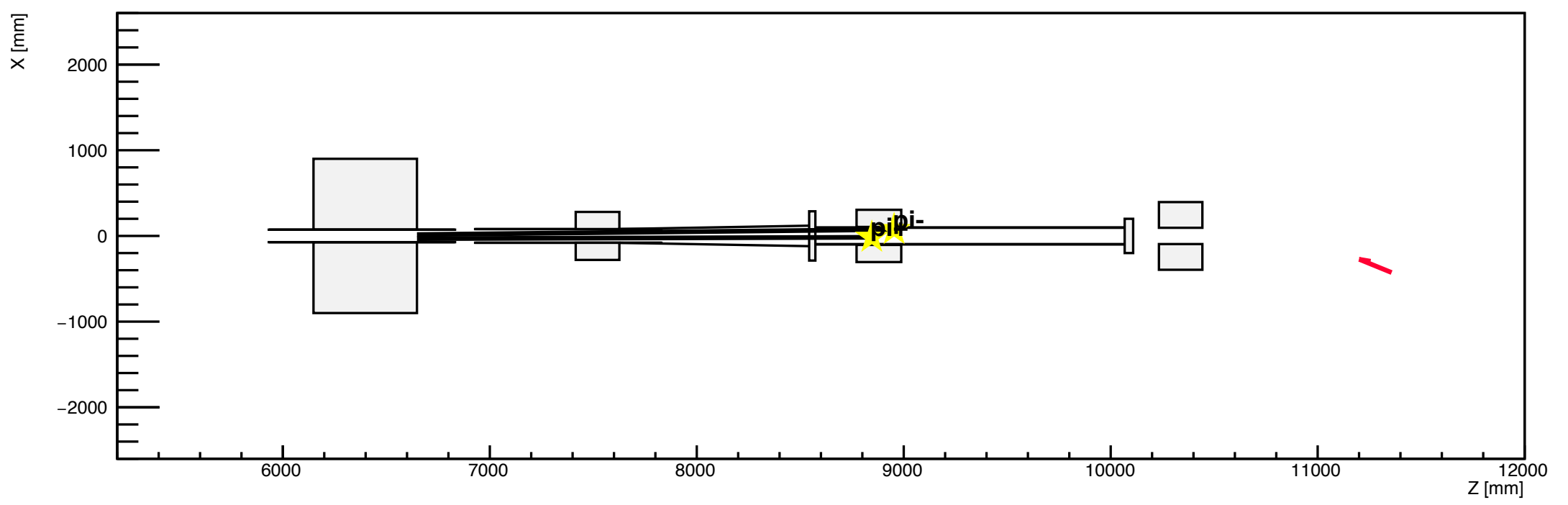

h1

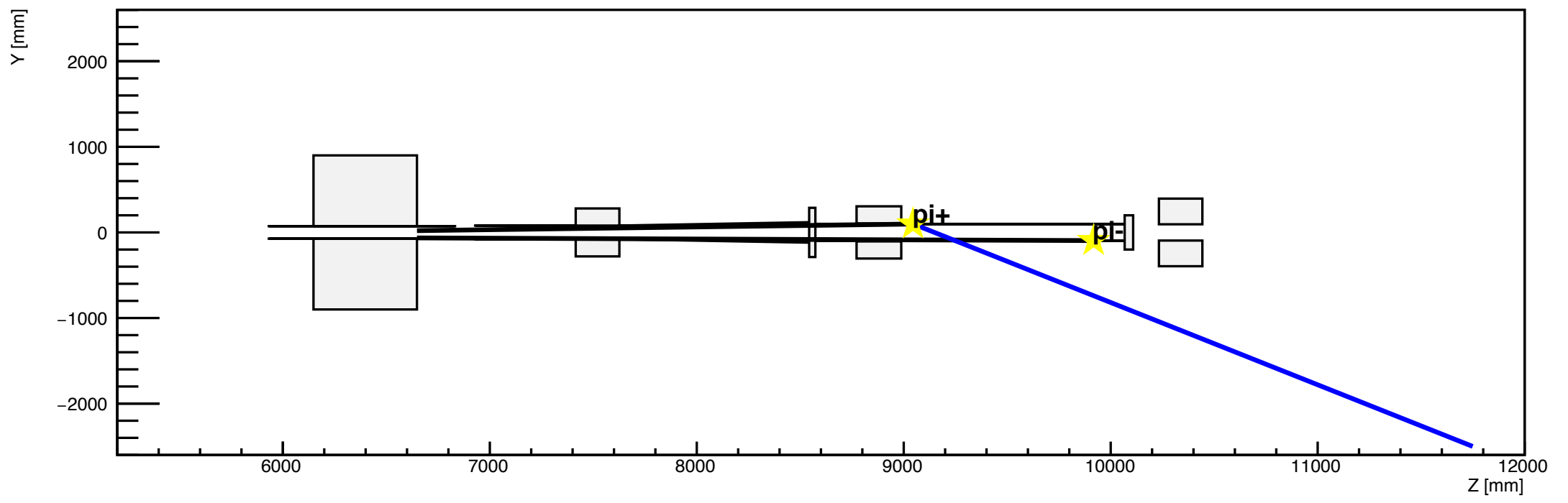

h2

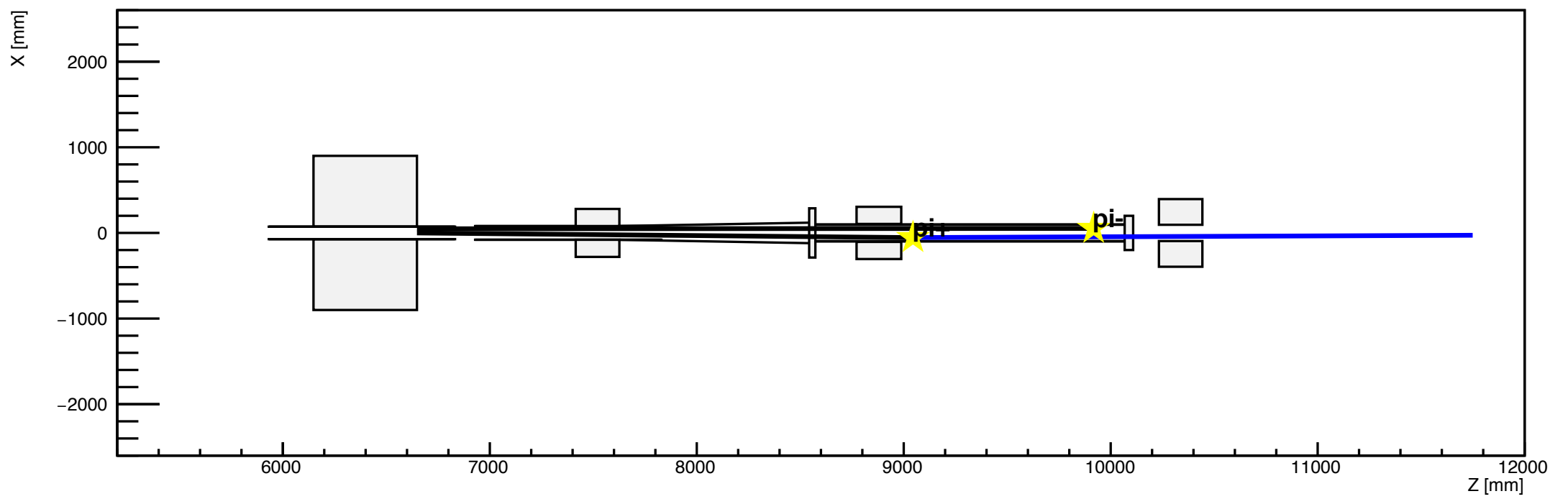

h1

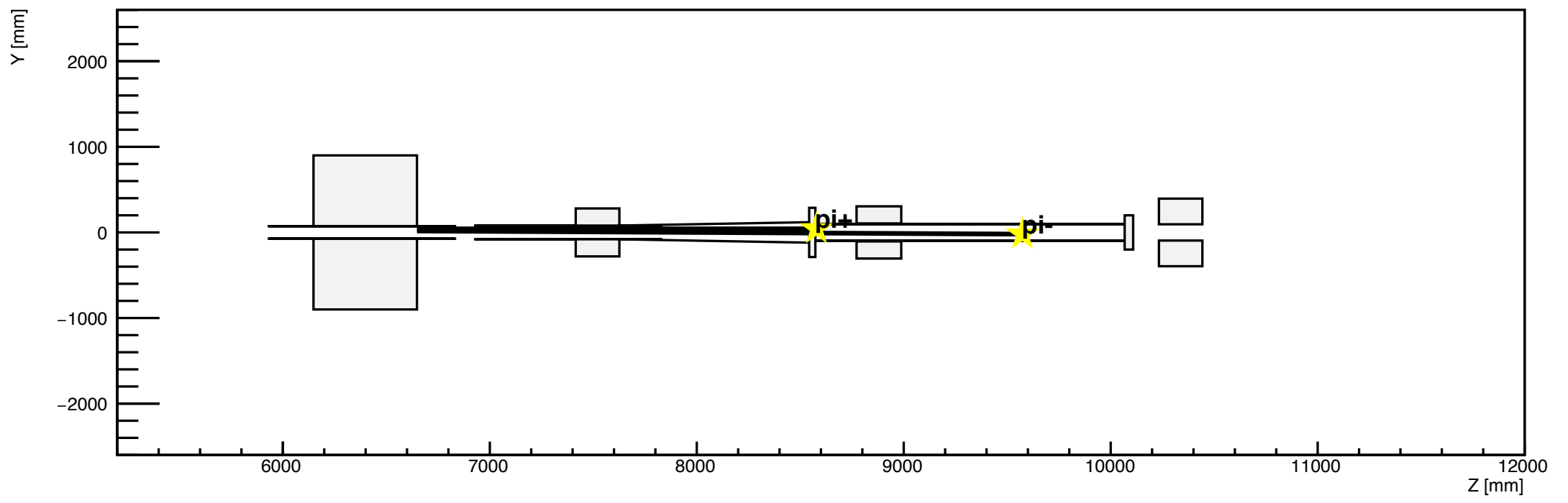

h2

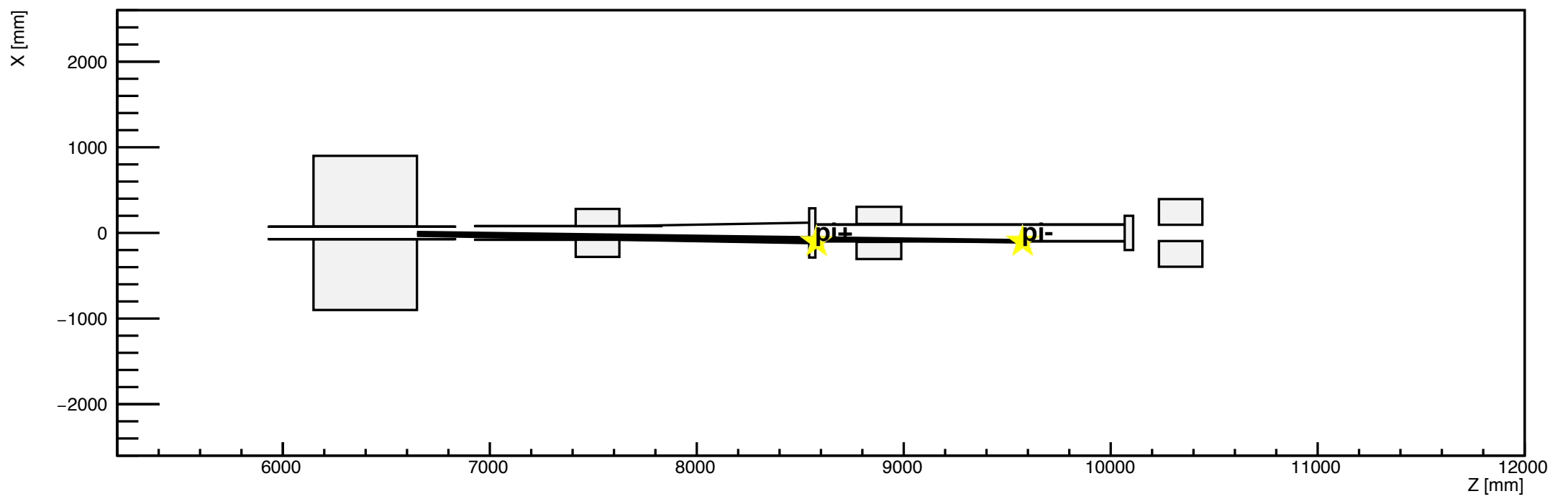

h1

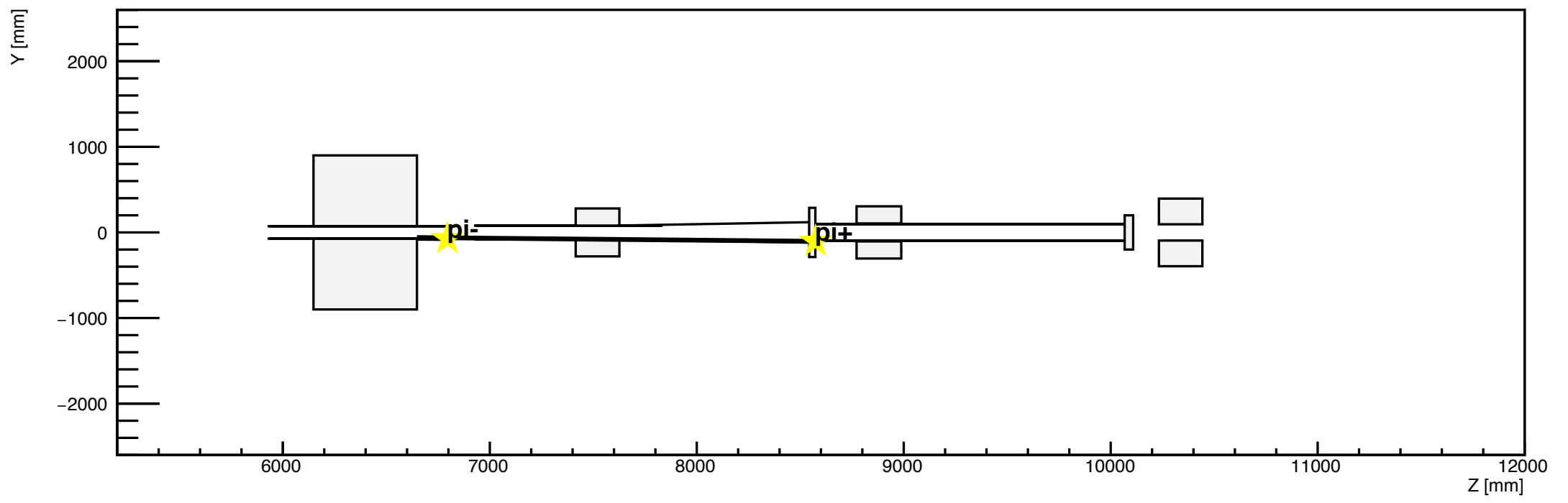

h2

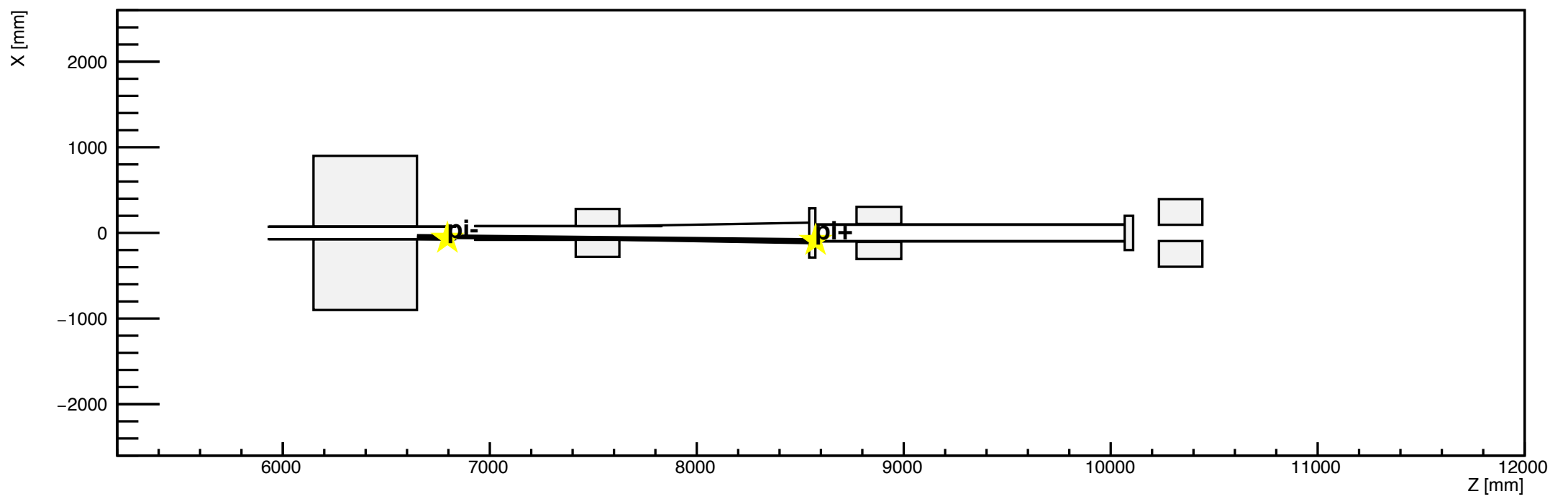

h1

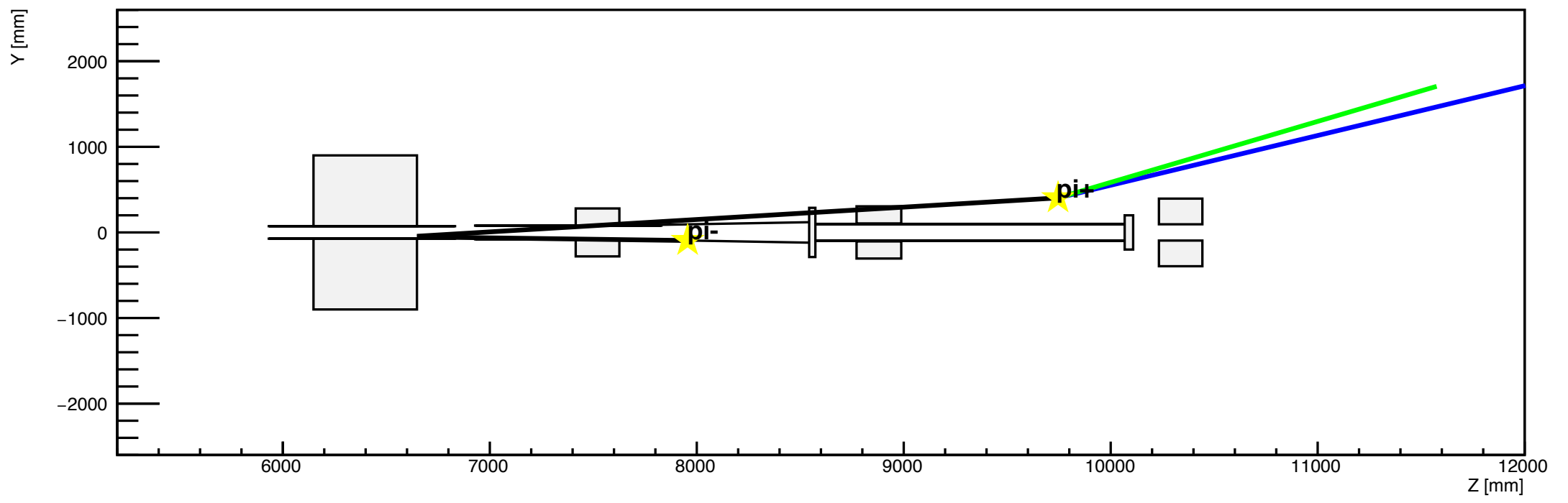

h2

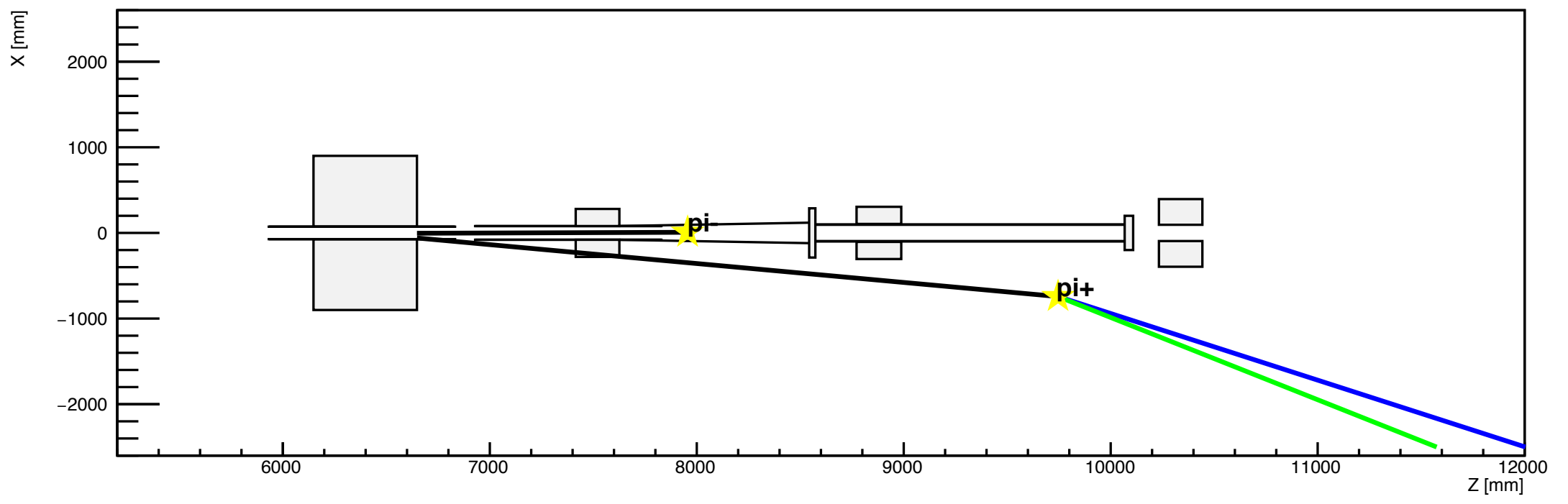

h1

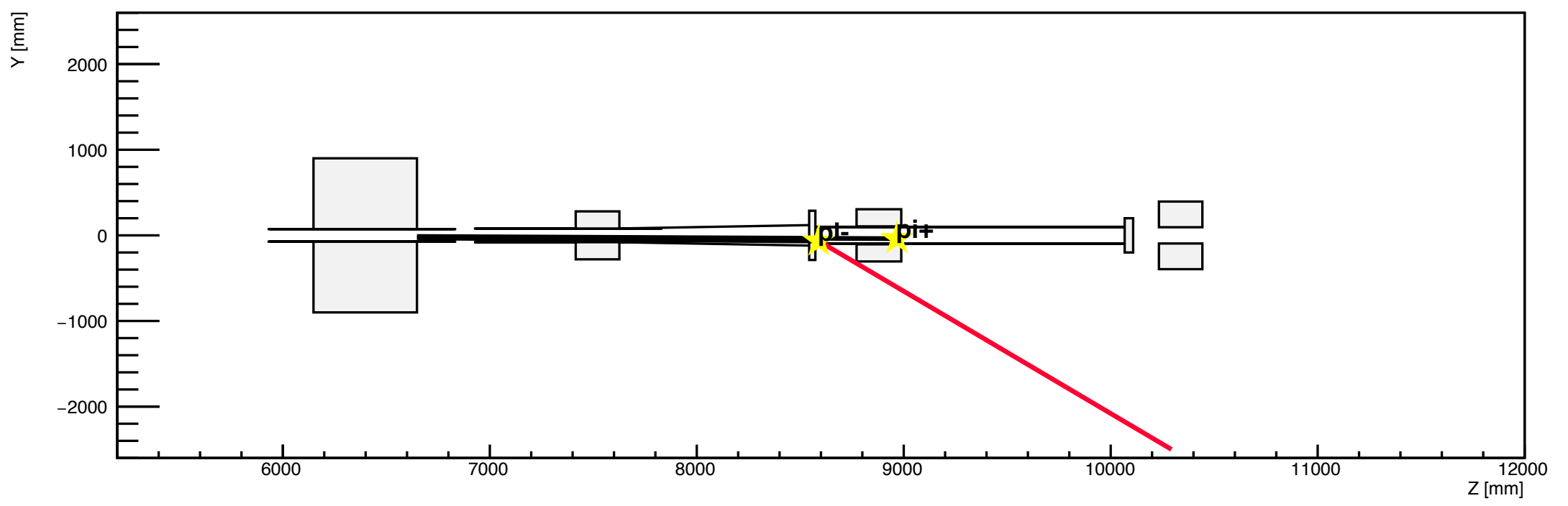

h2

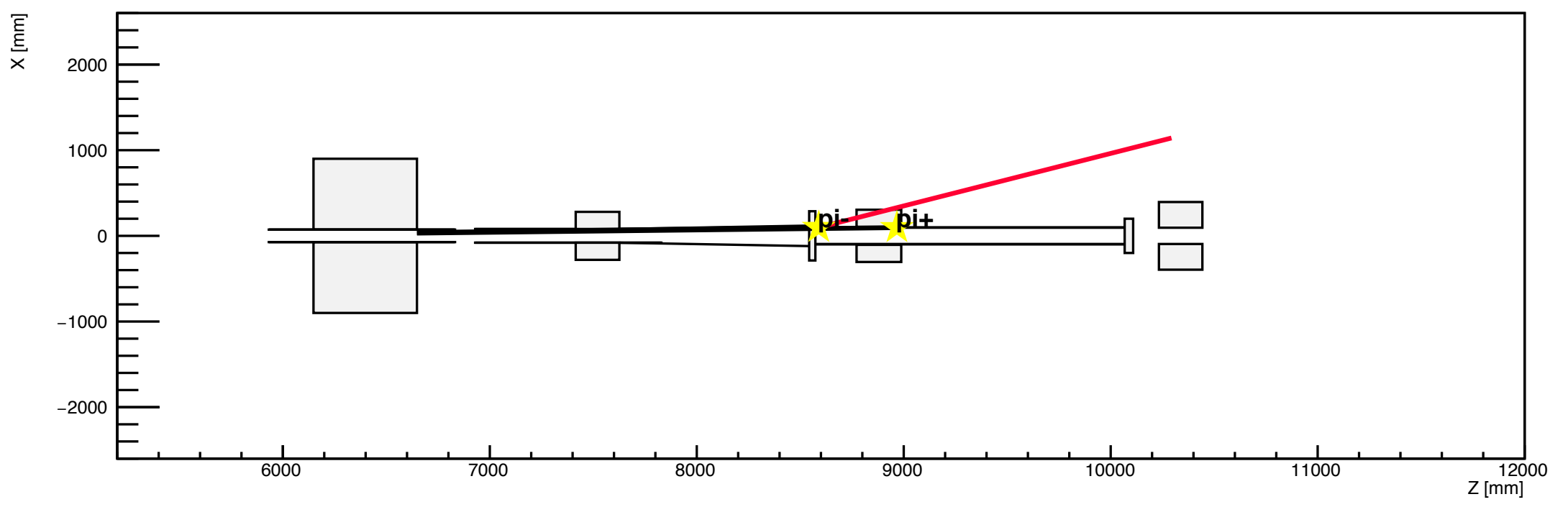

h1

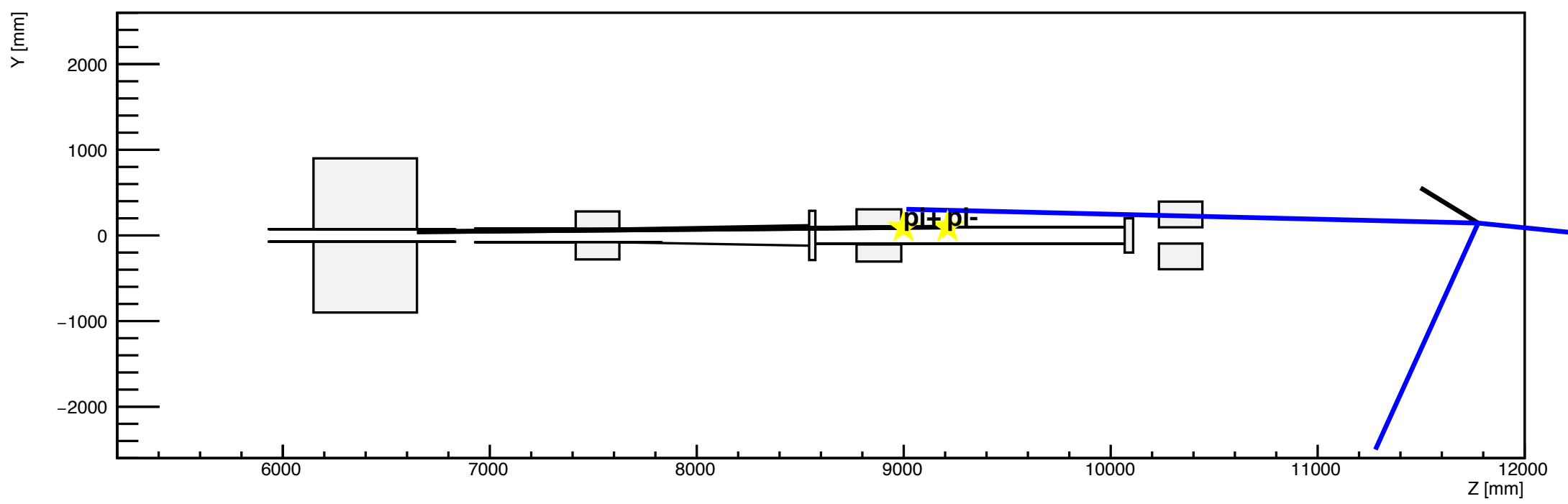

h2

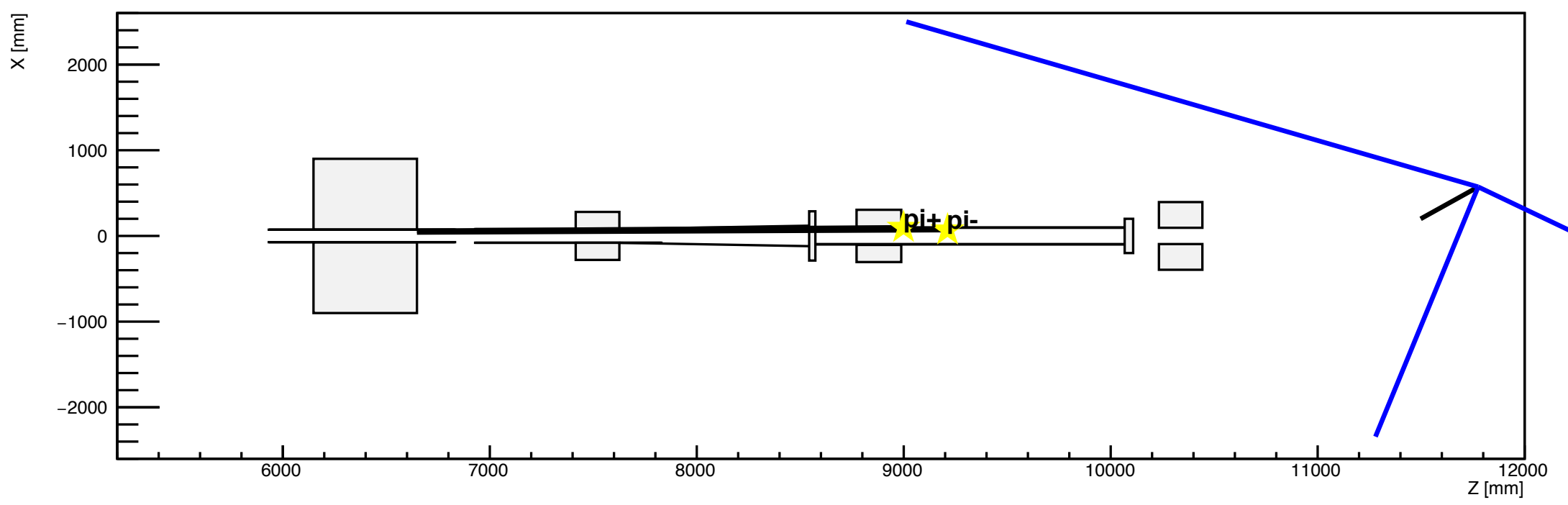

h1

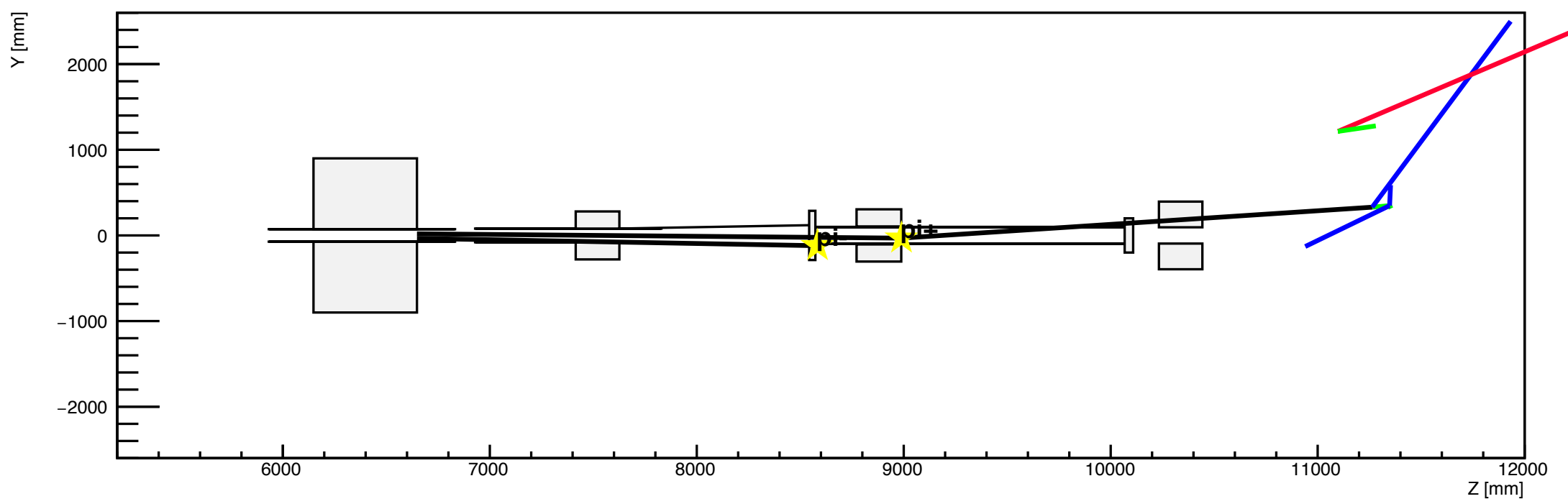

h2

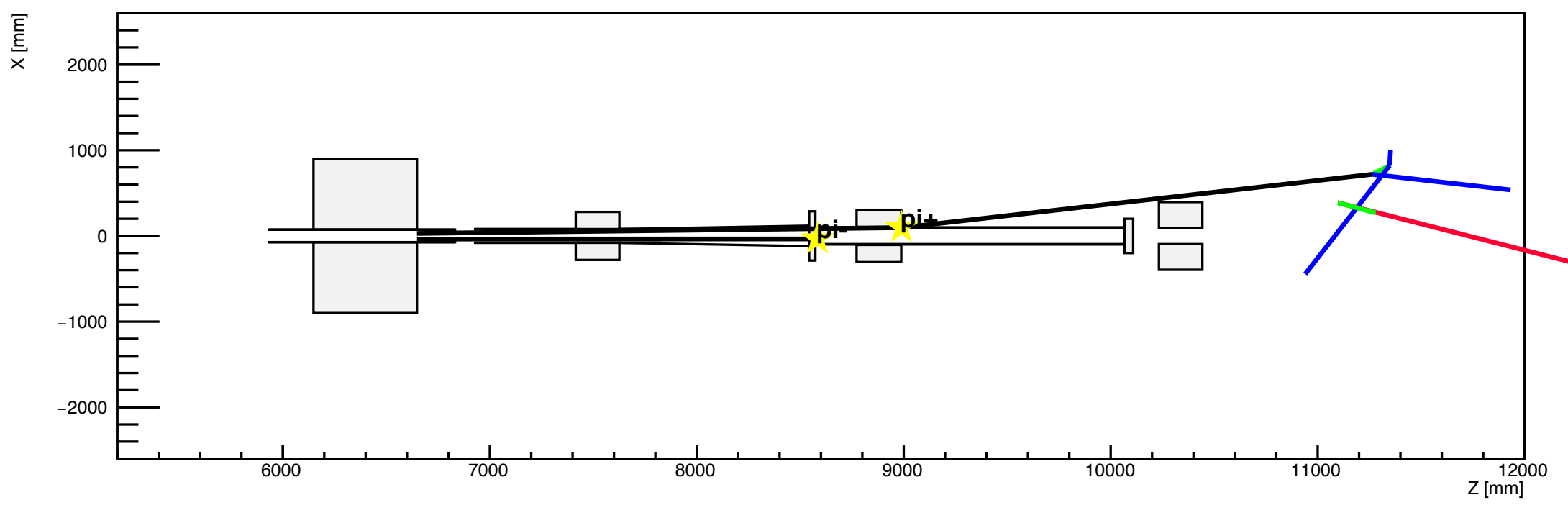

h1

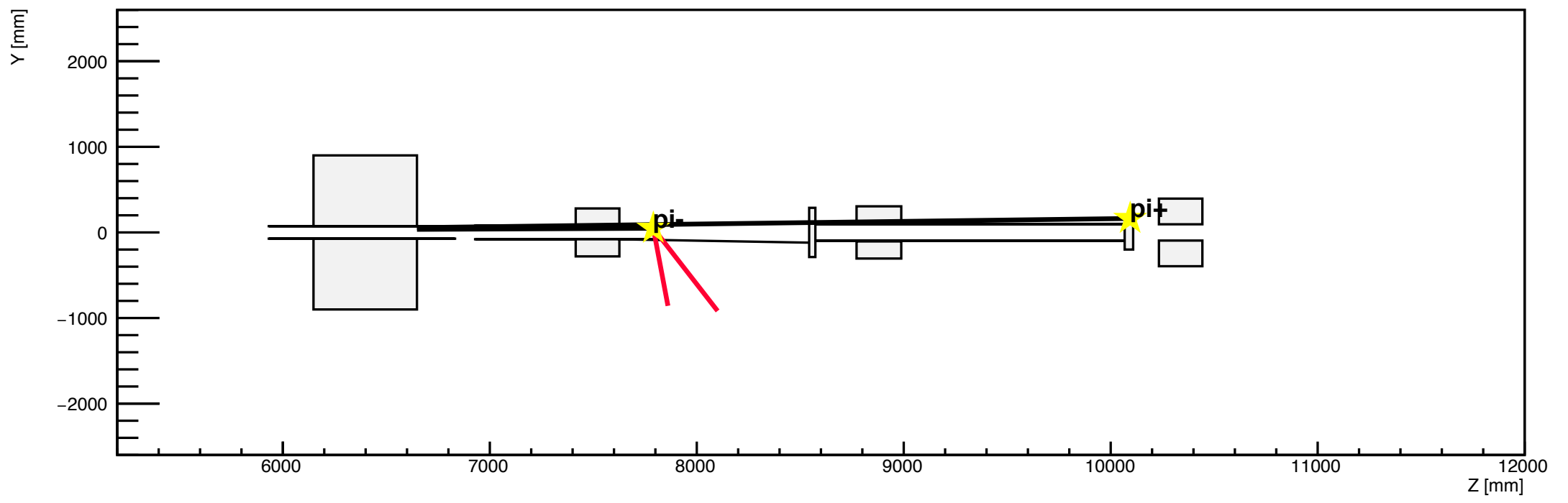

h2

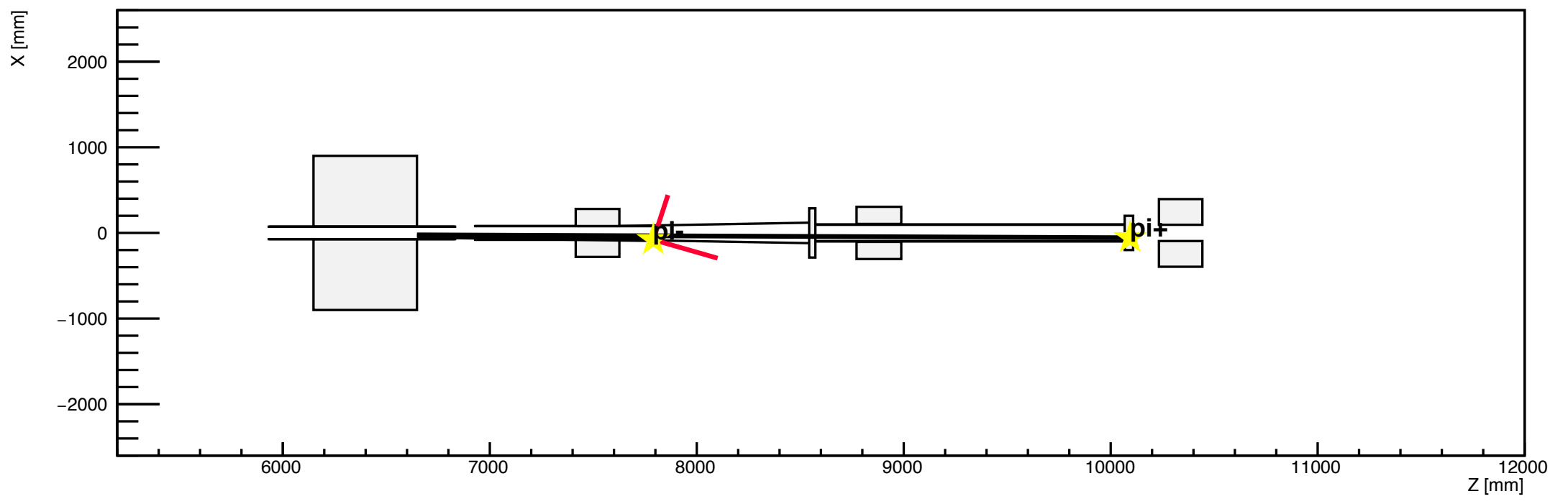

h1

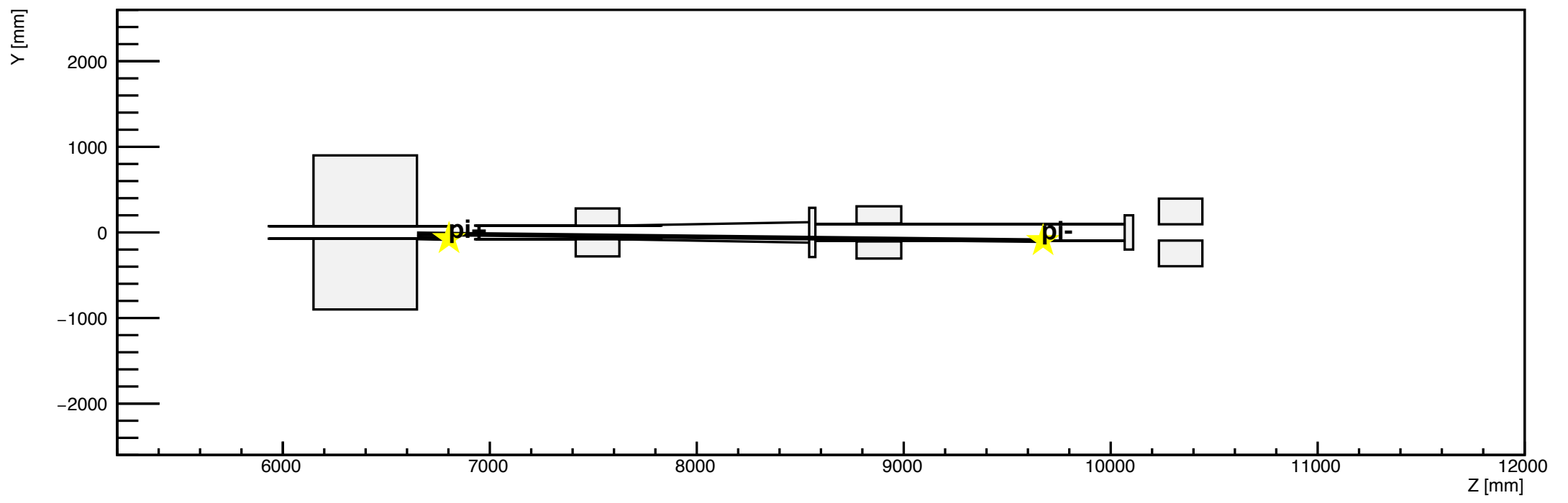

h2

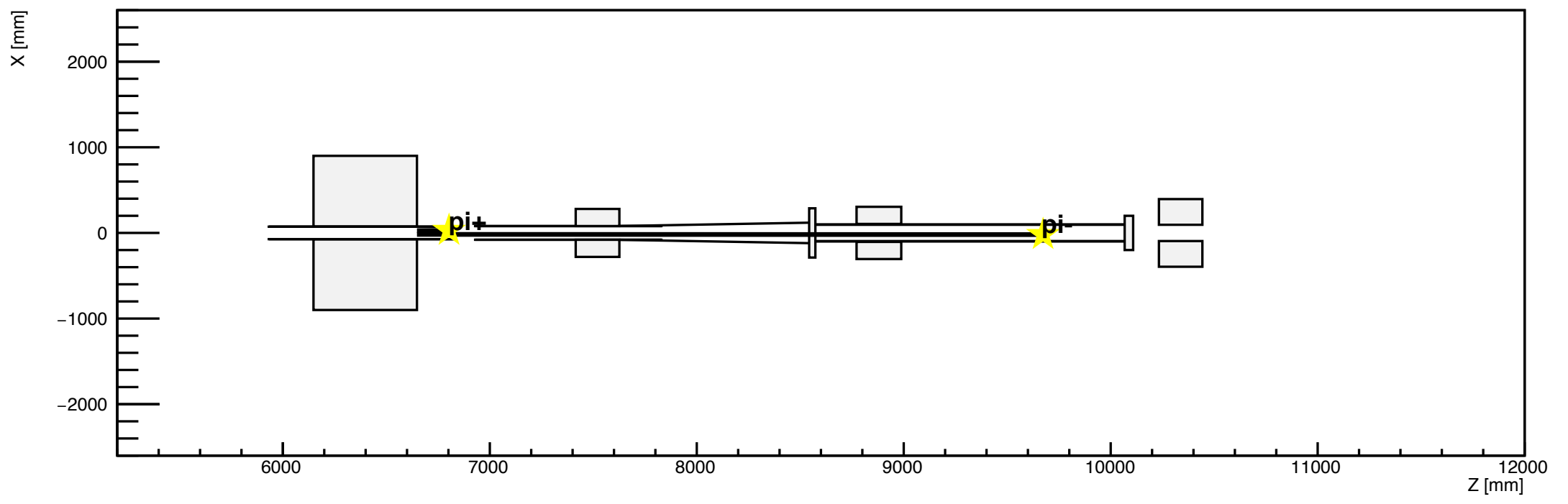

h1

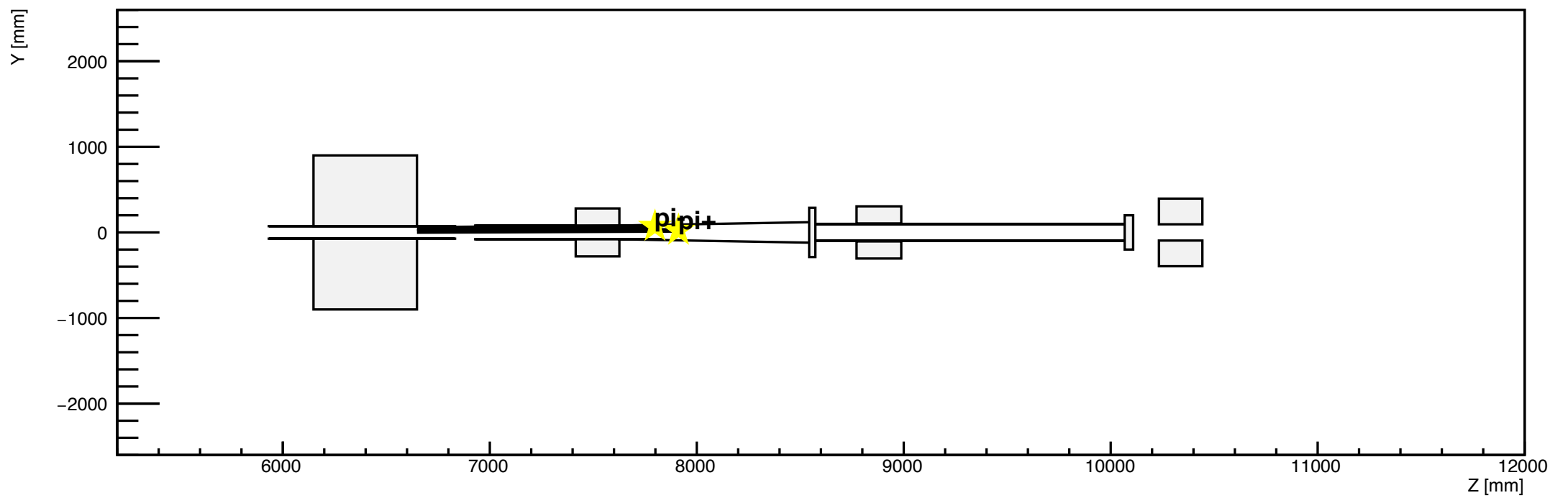

h2

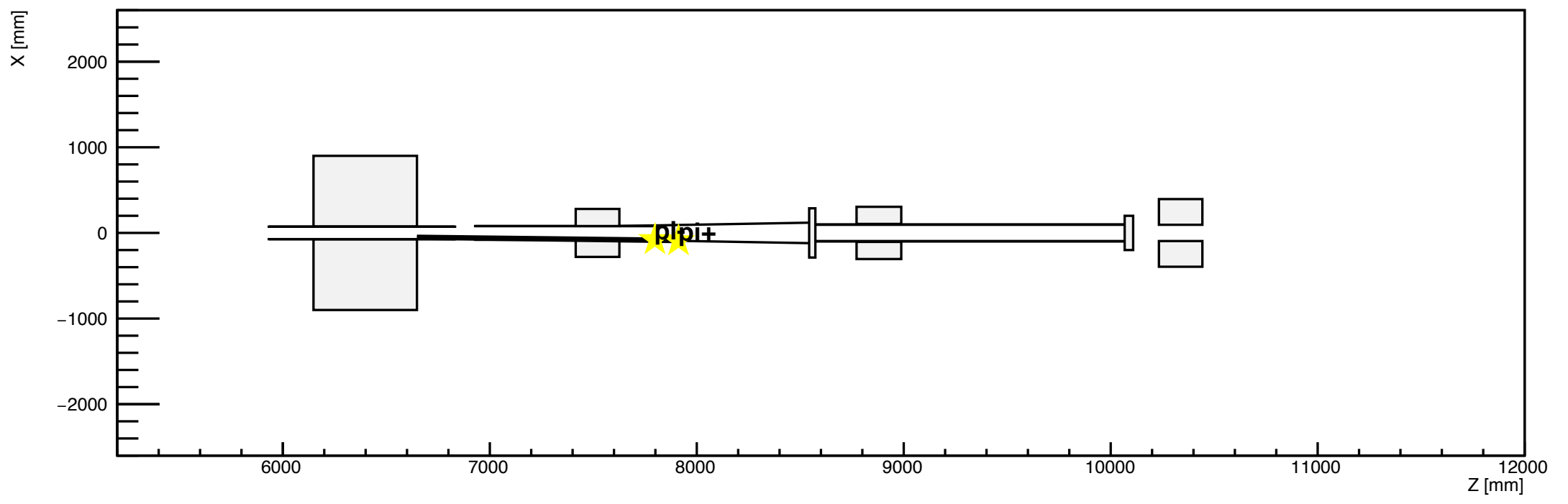

h1

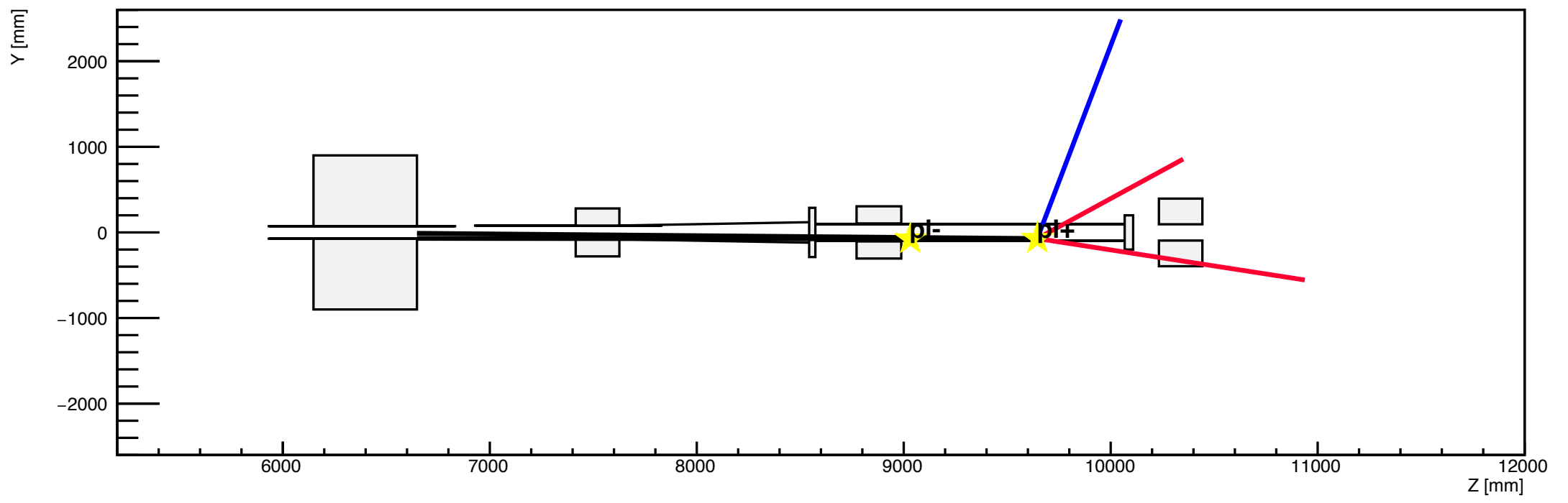

h2

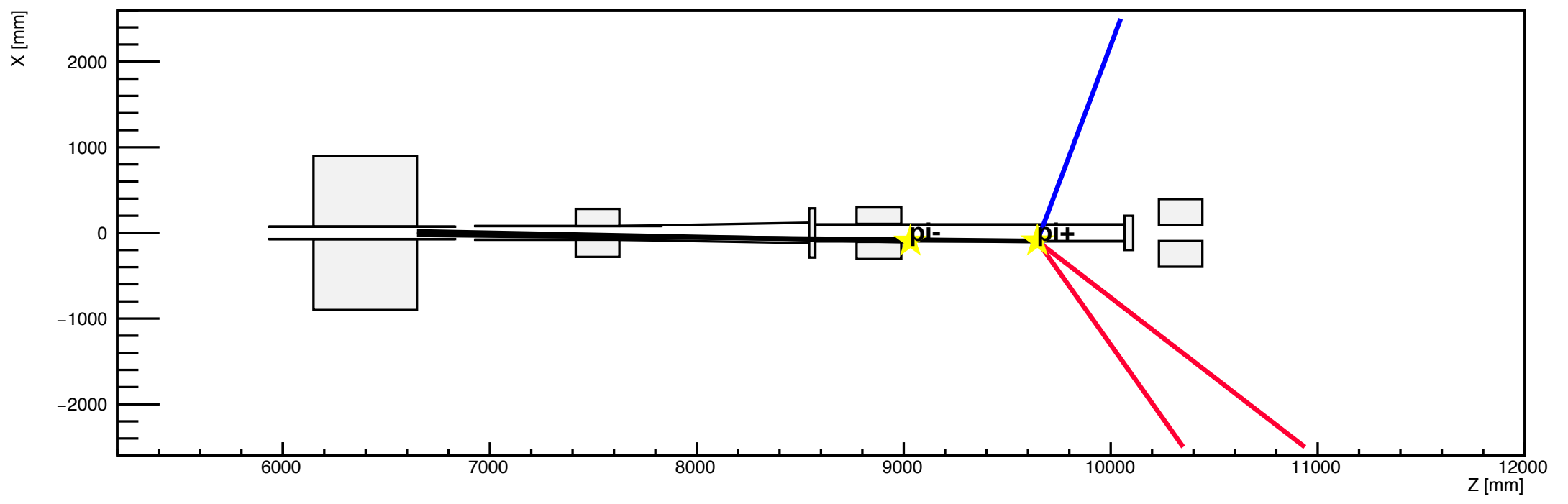

h1

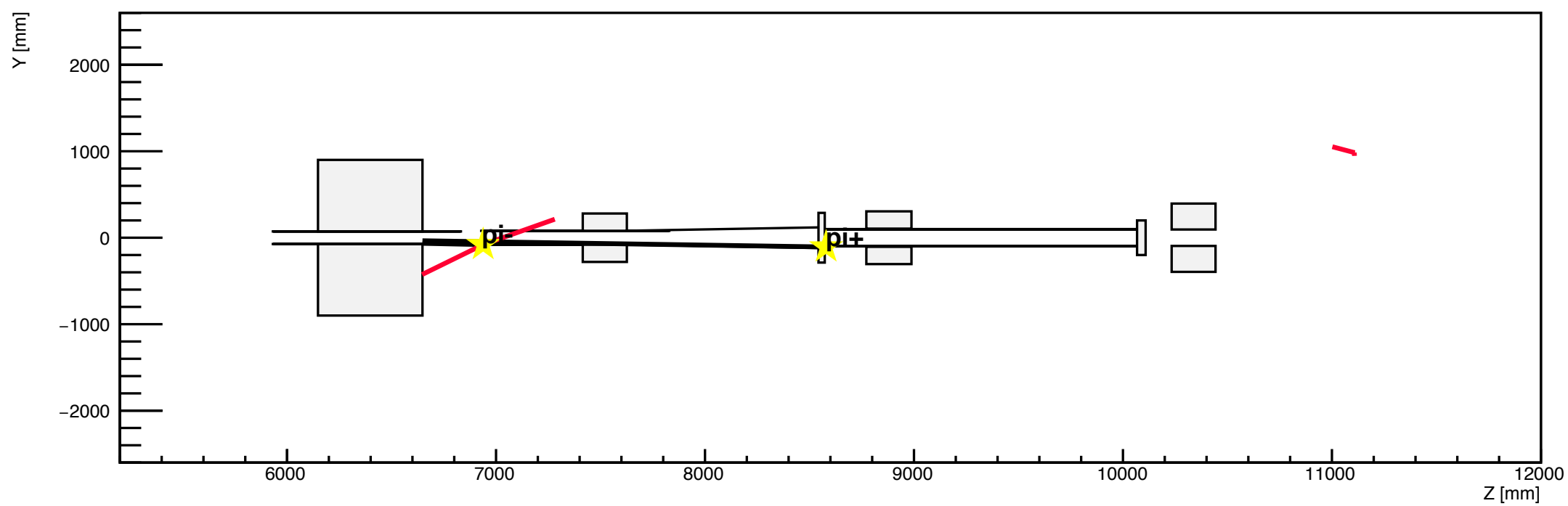

h2

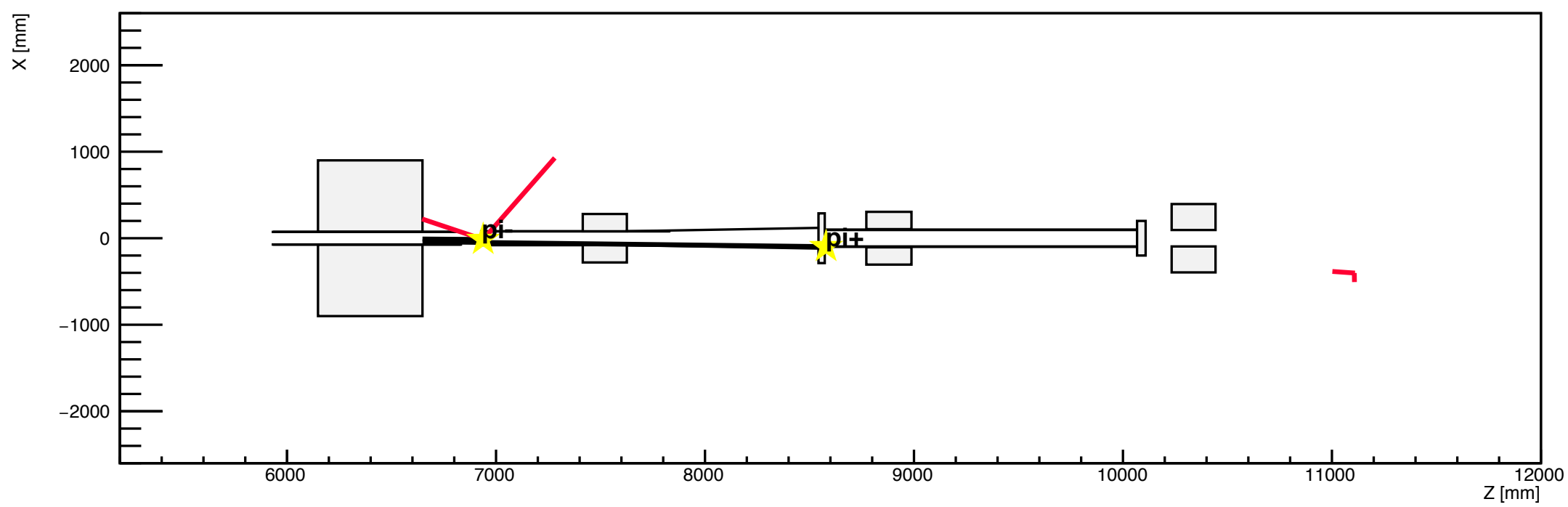

h1

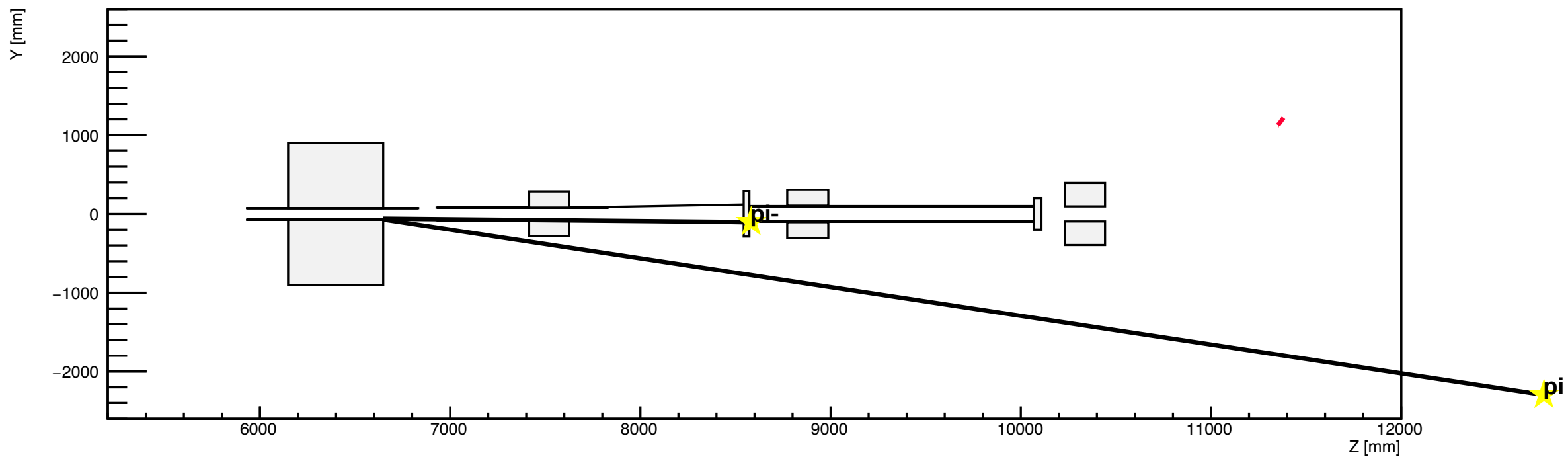

h2

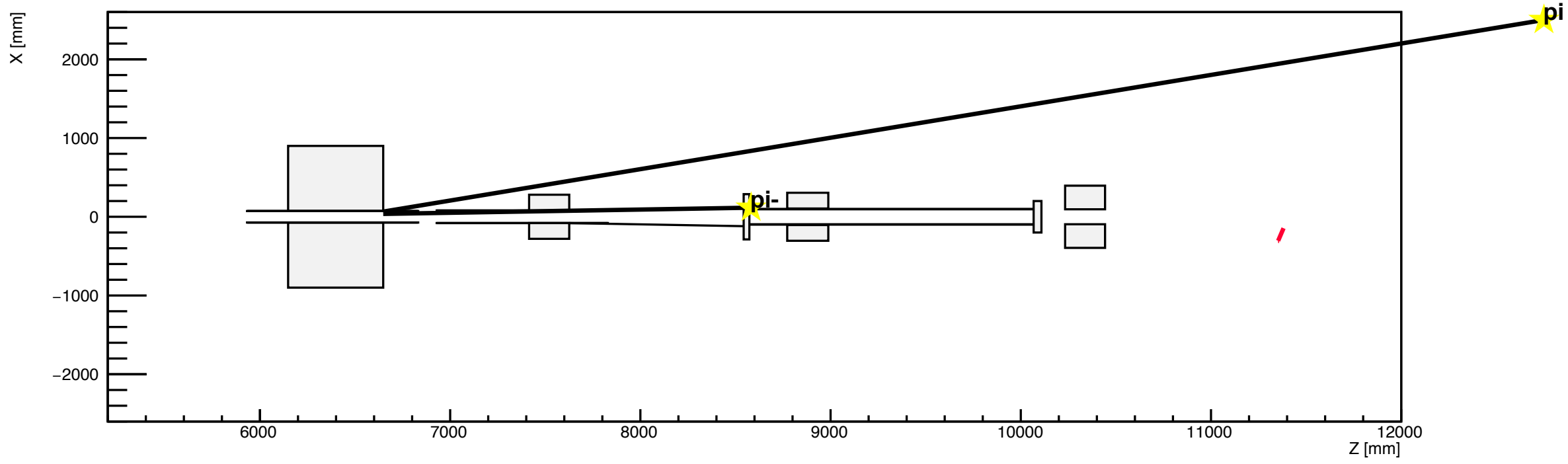

h1

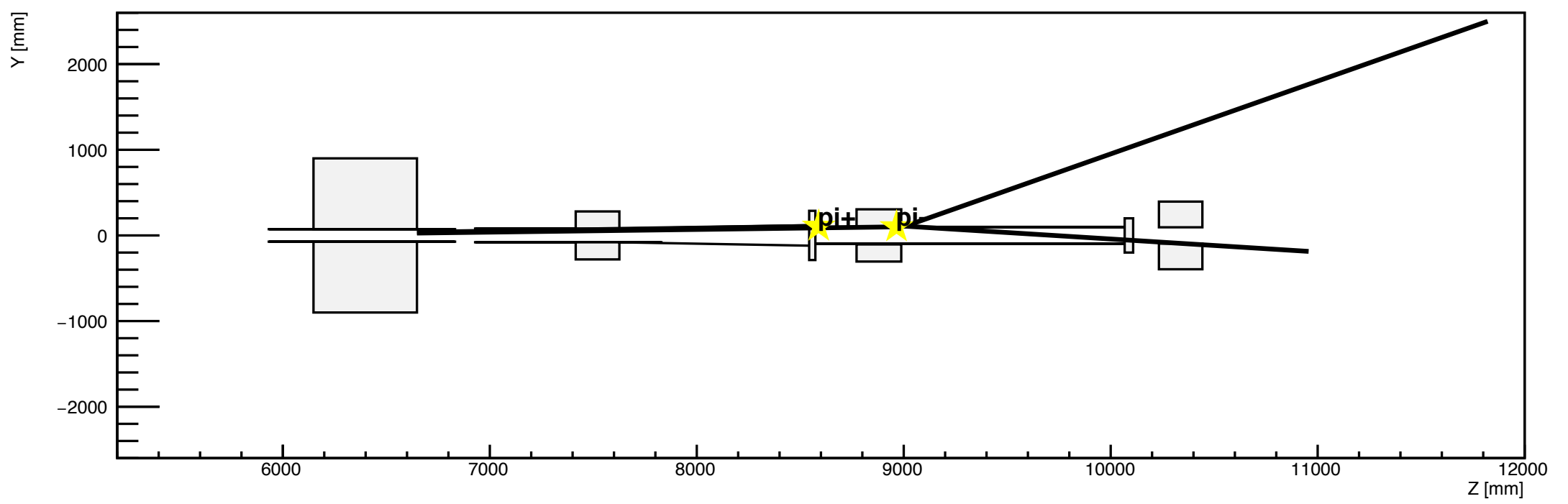

h2

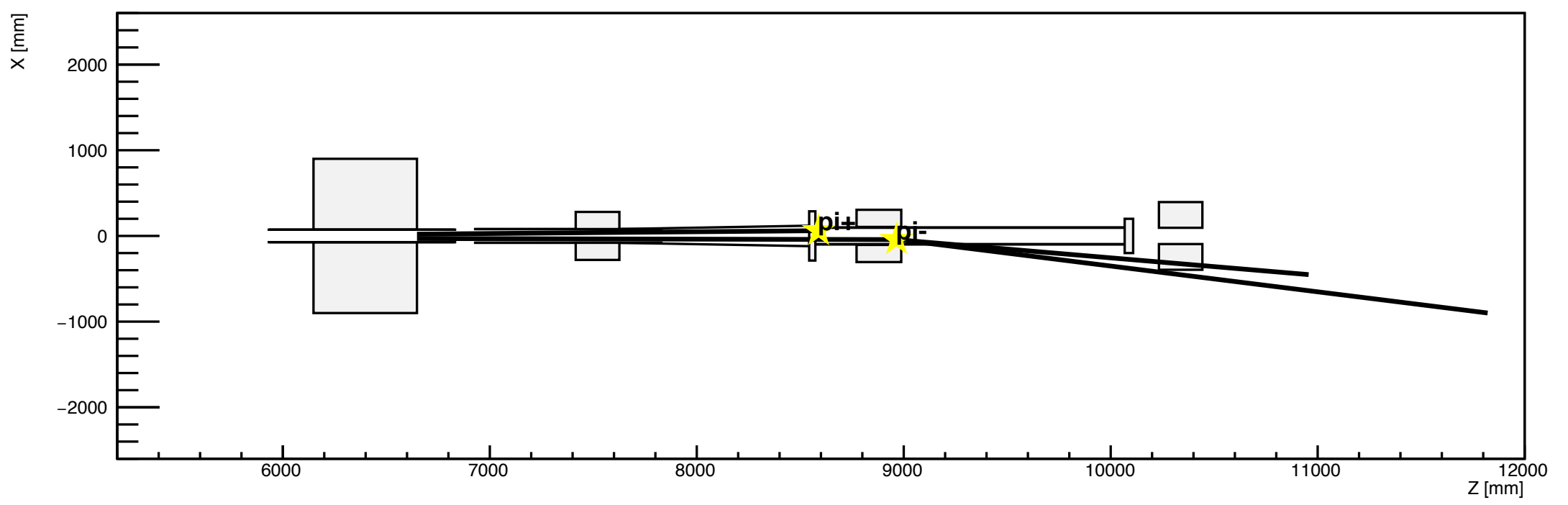

h1

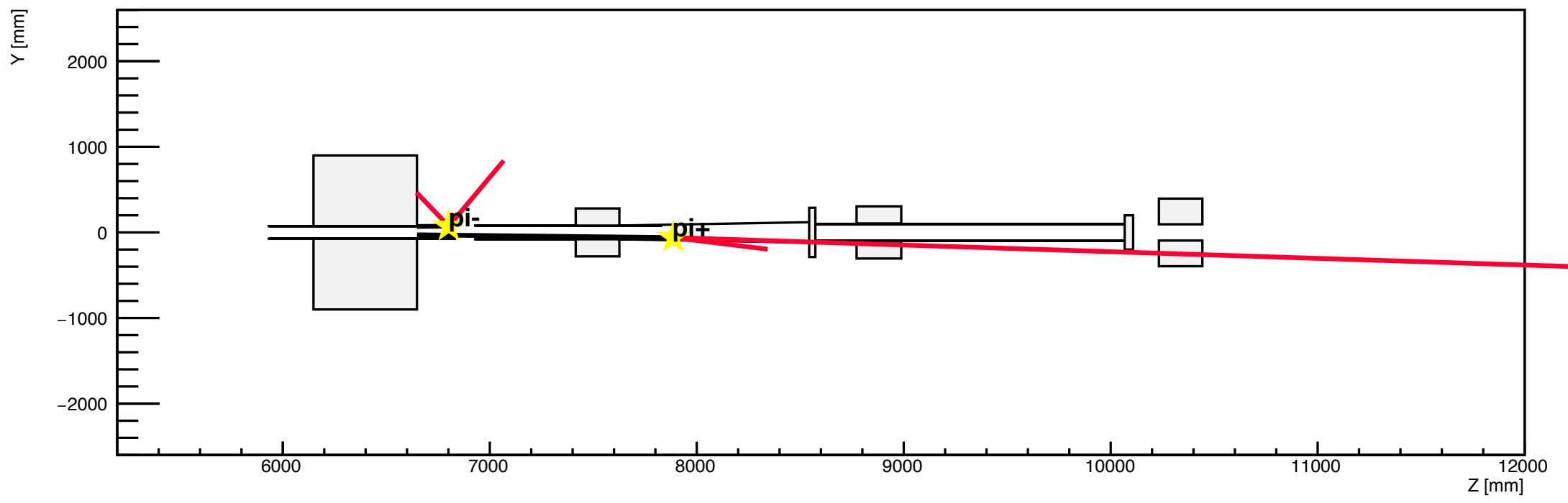

h2

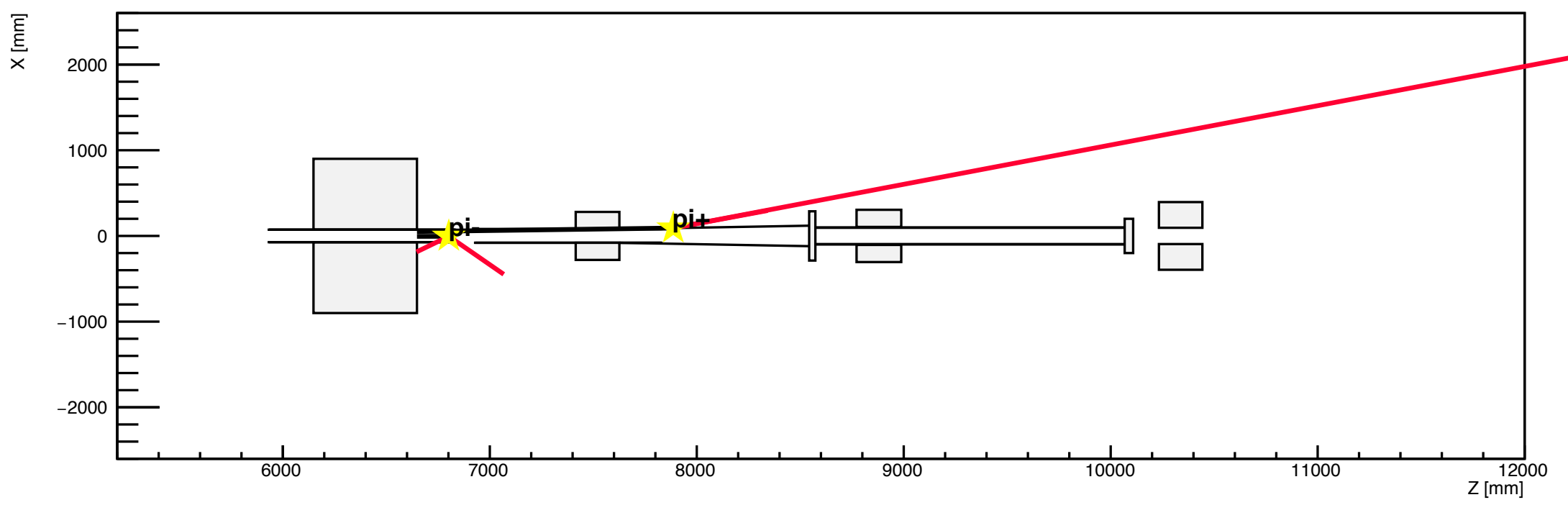

h1

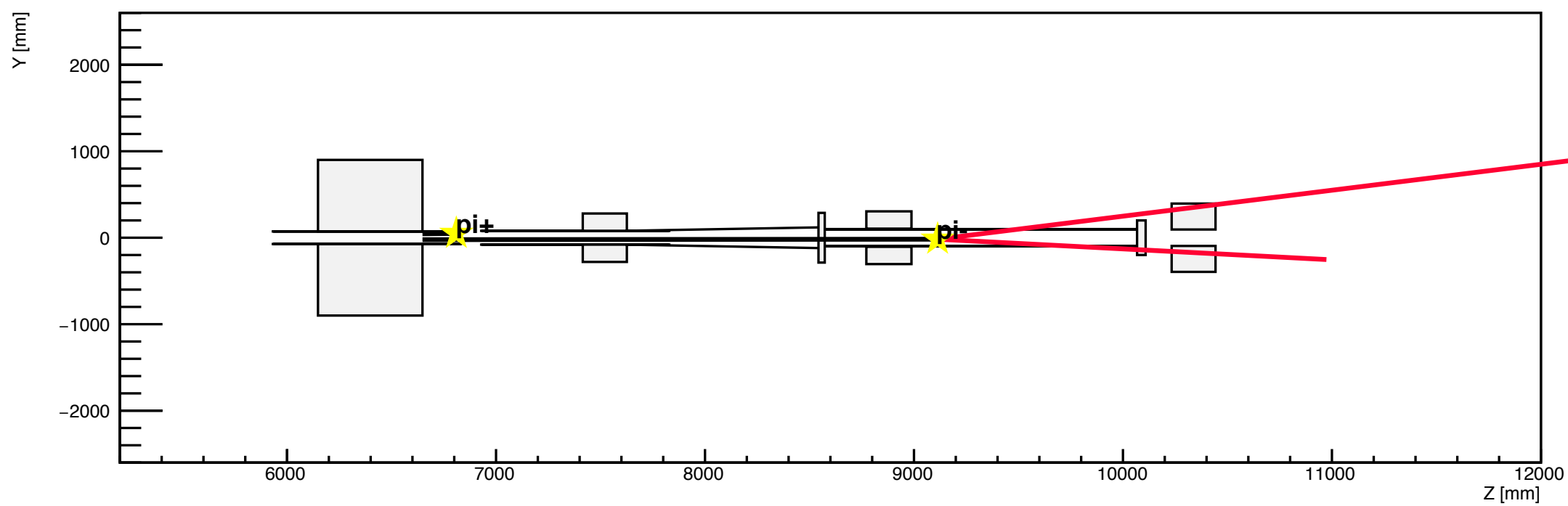

h2

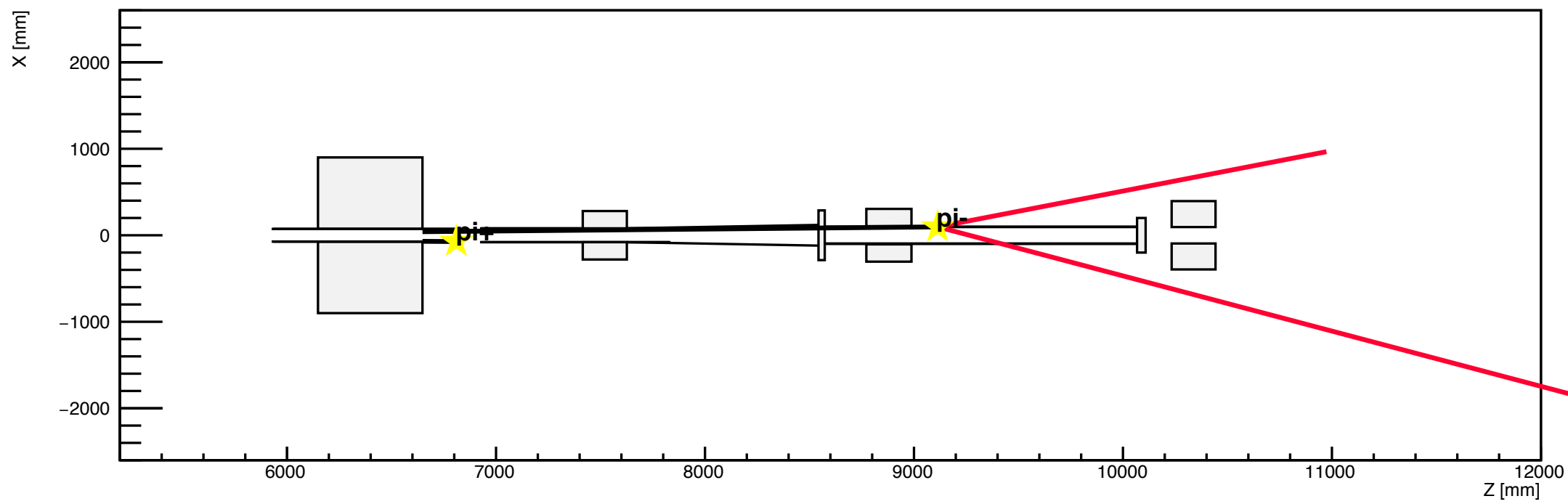

h1

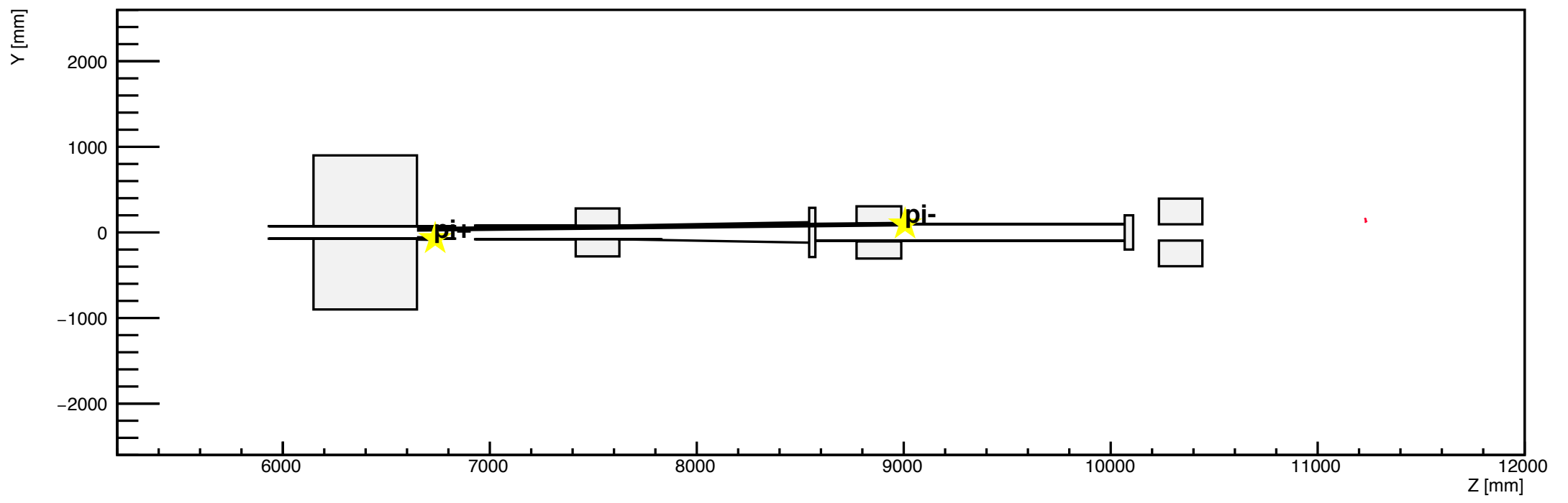

h2

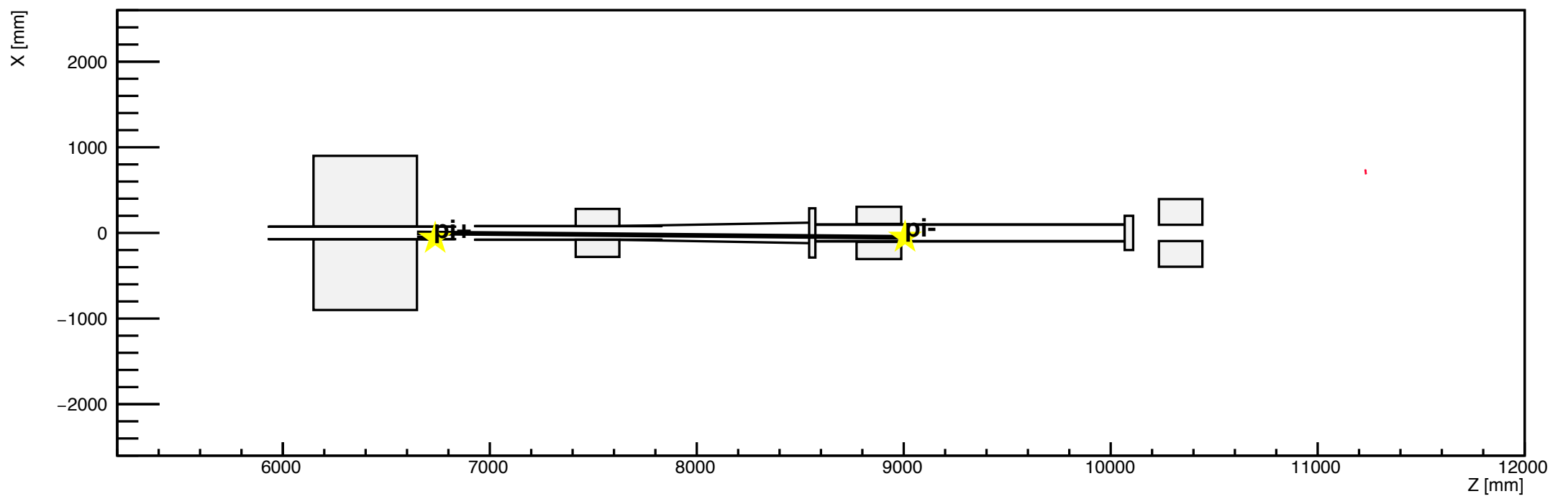

h1

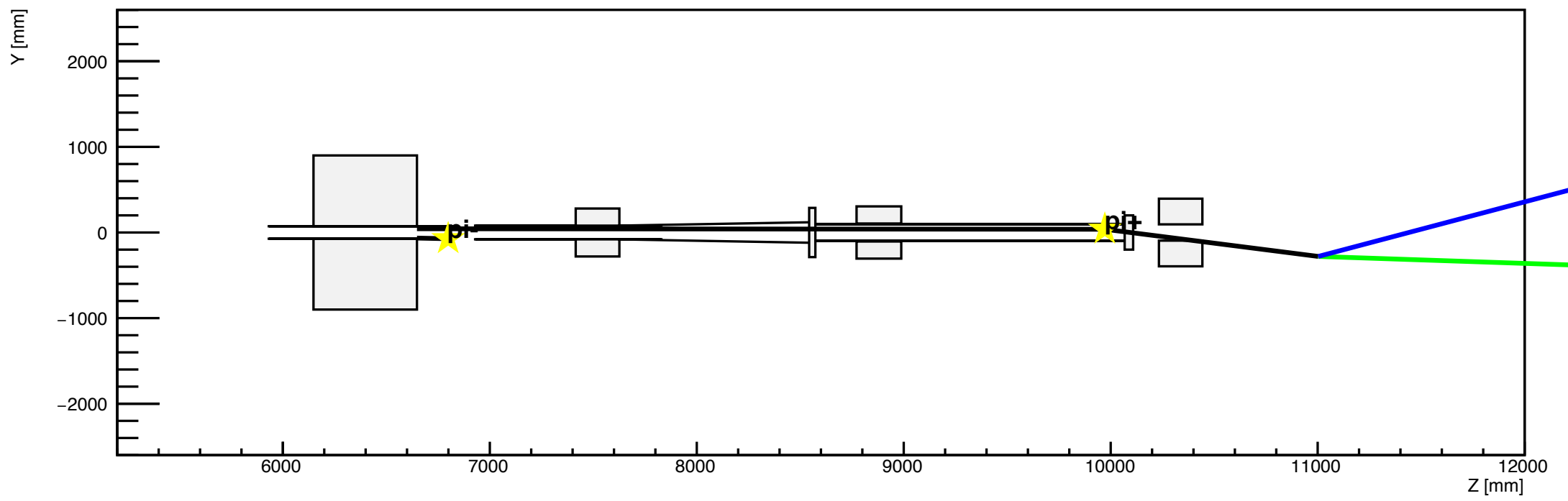

h2

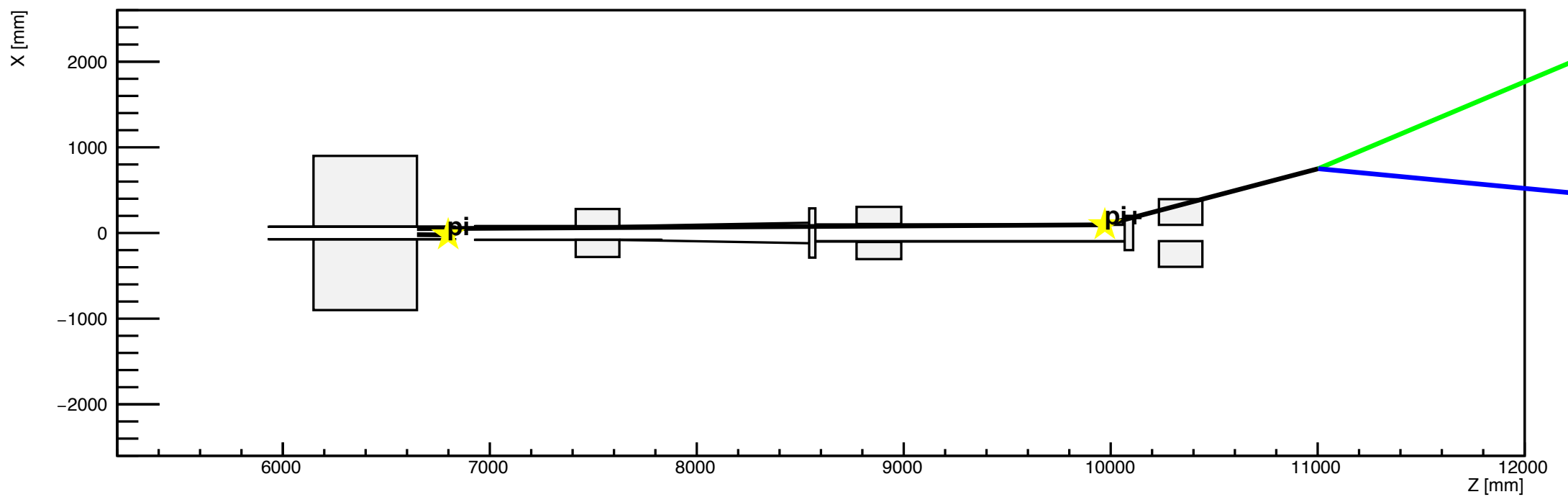

h1

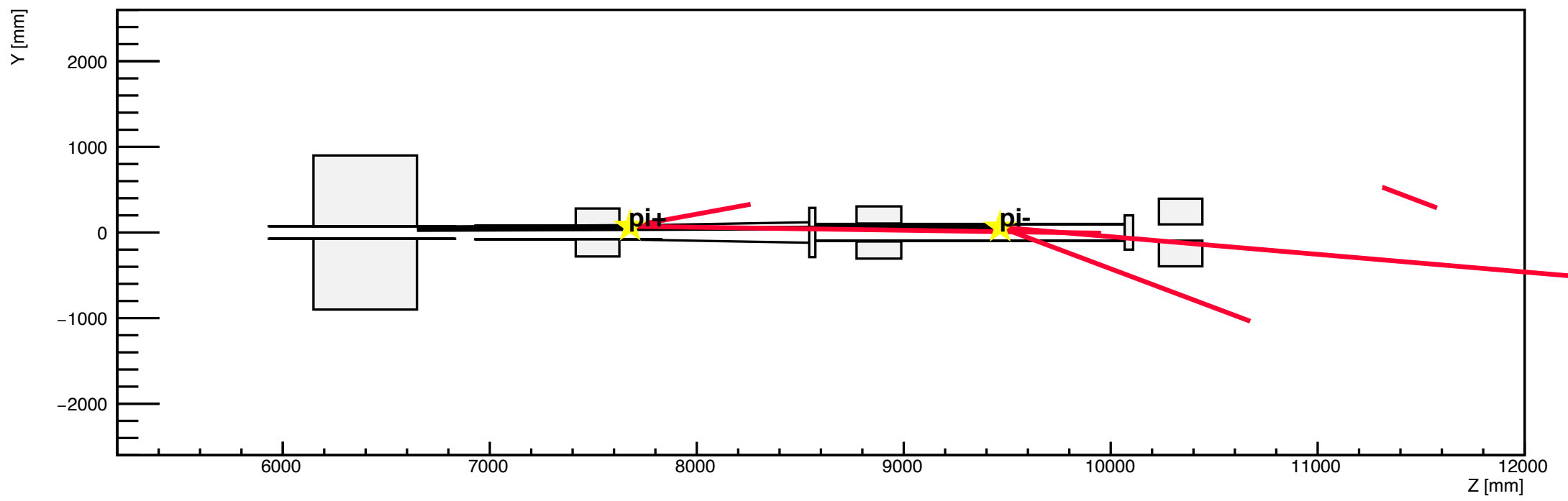

h2

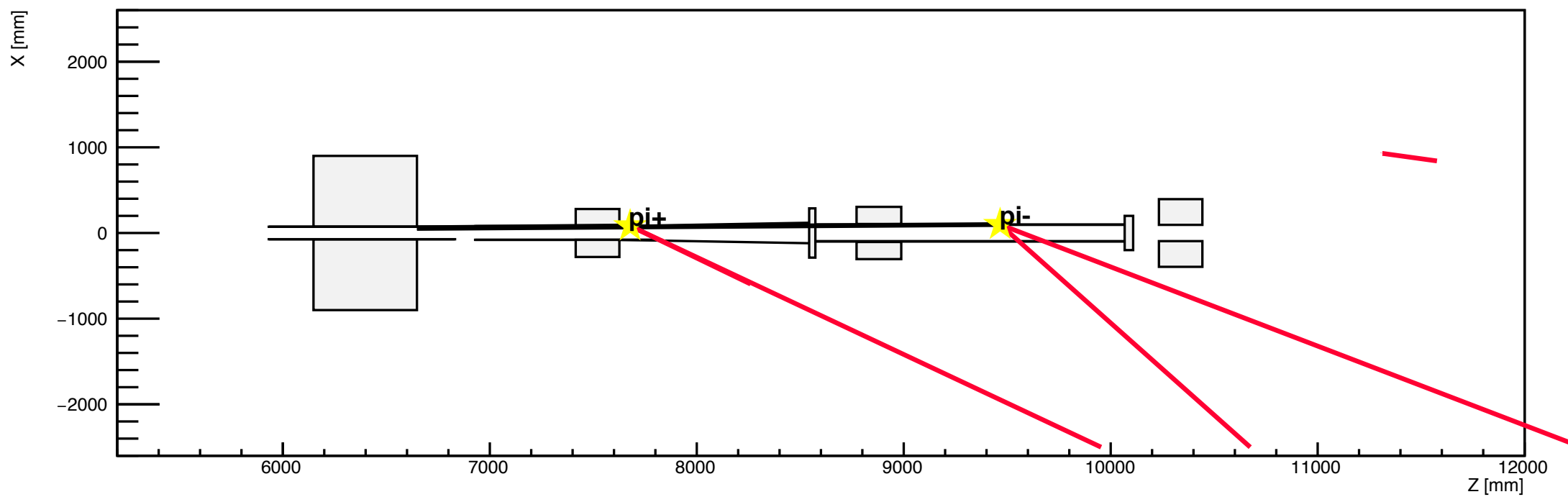

h1

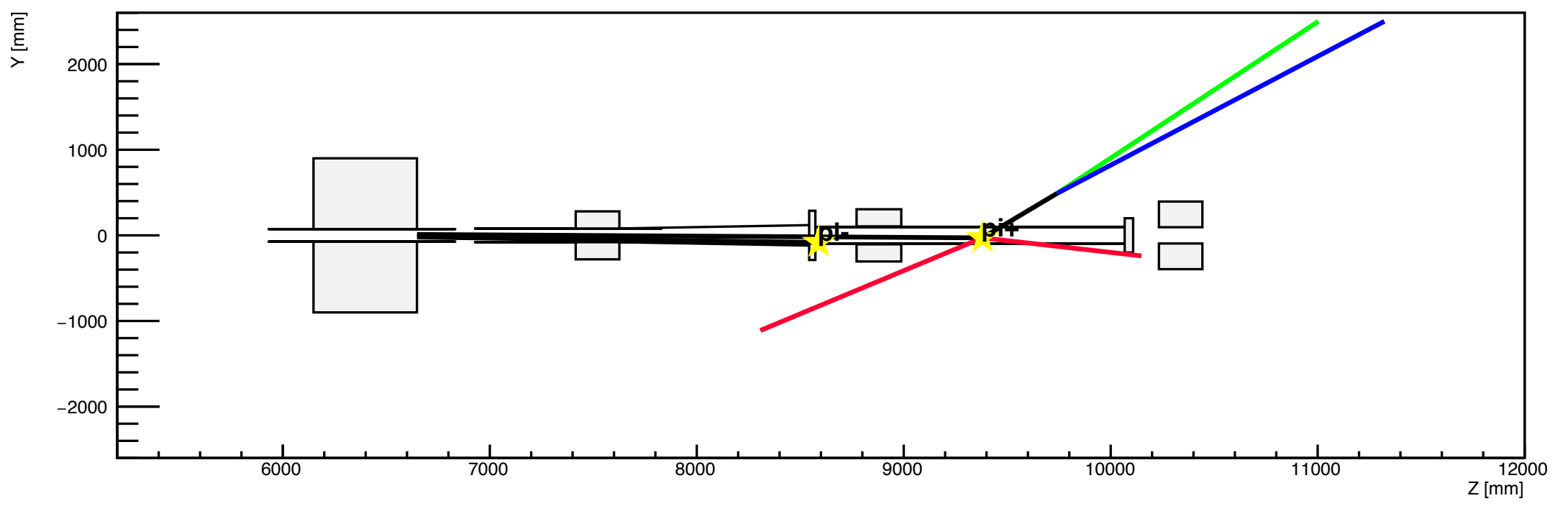

h2

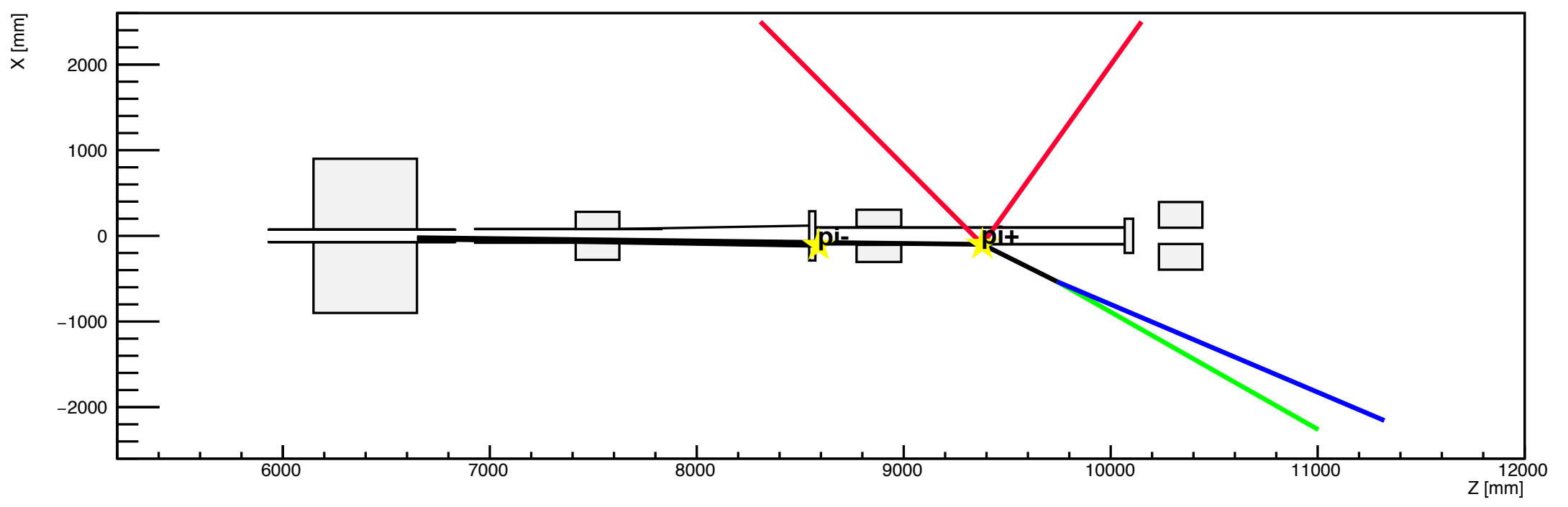

h1

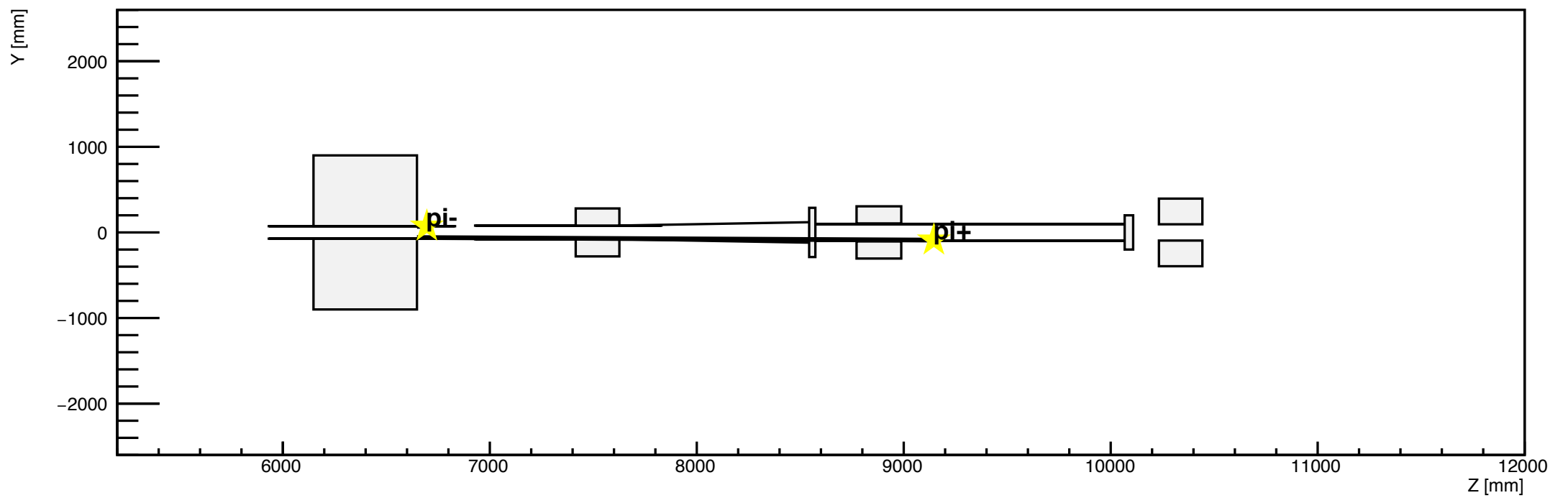

h2

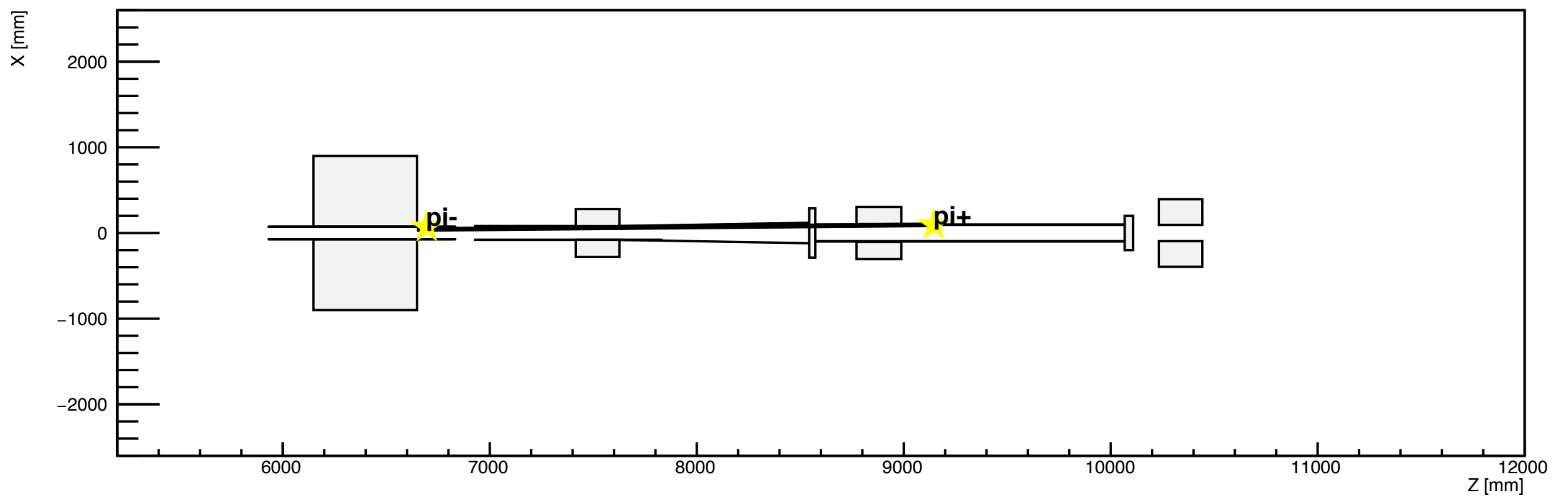

h1

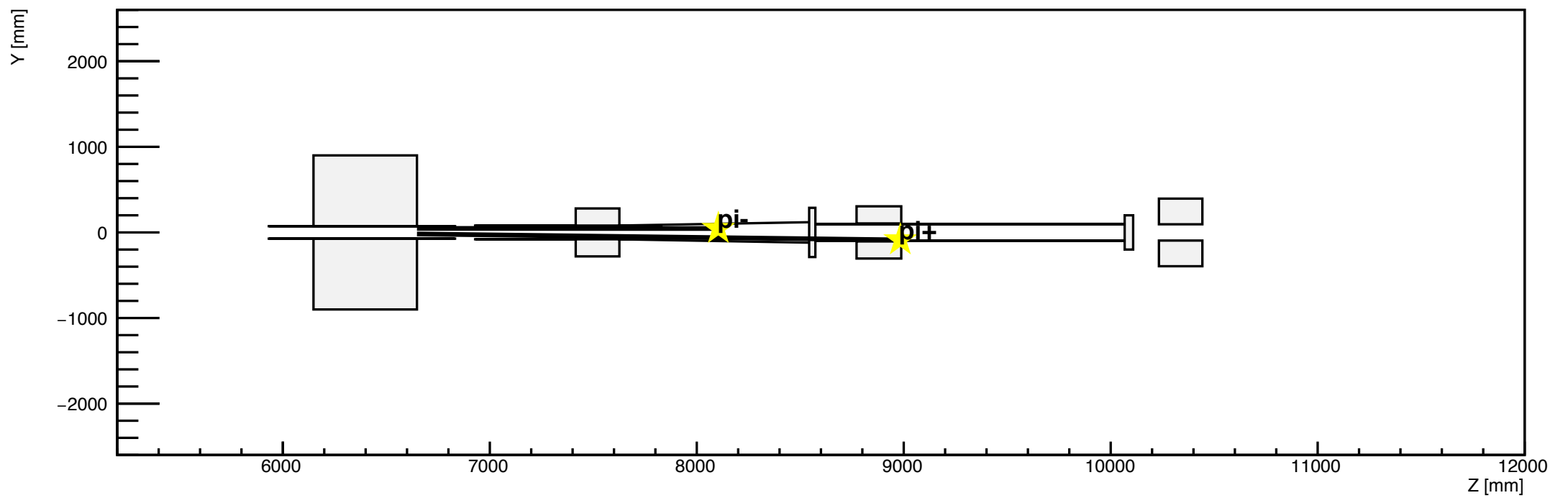

h2

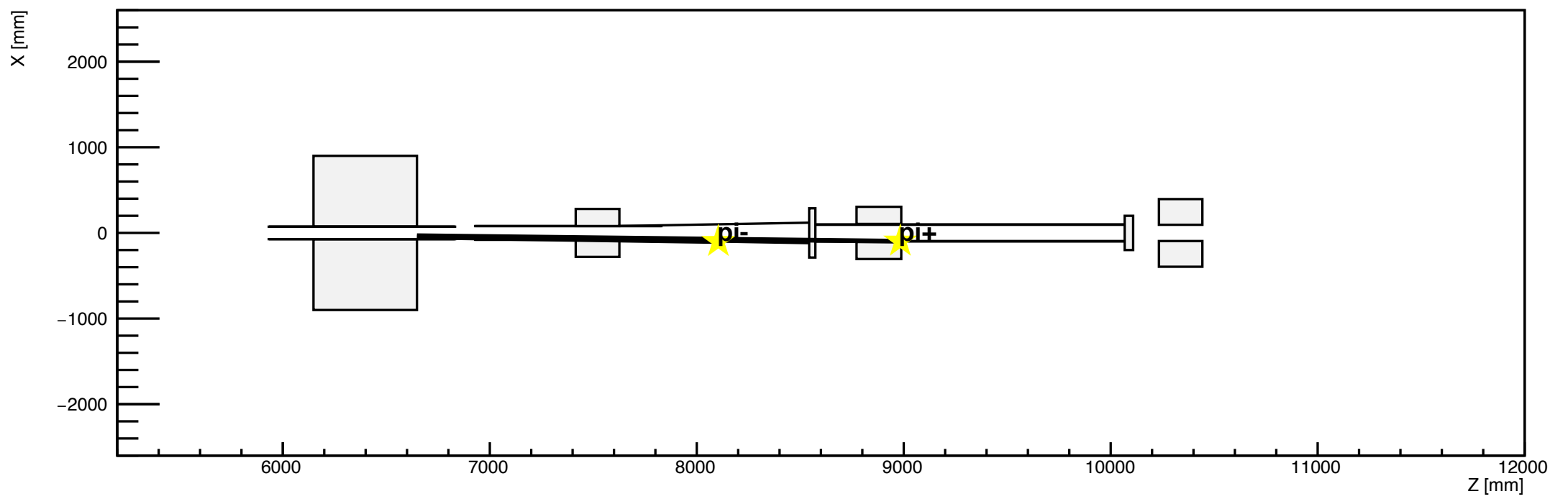

h1

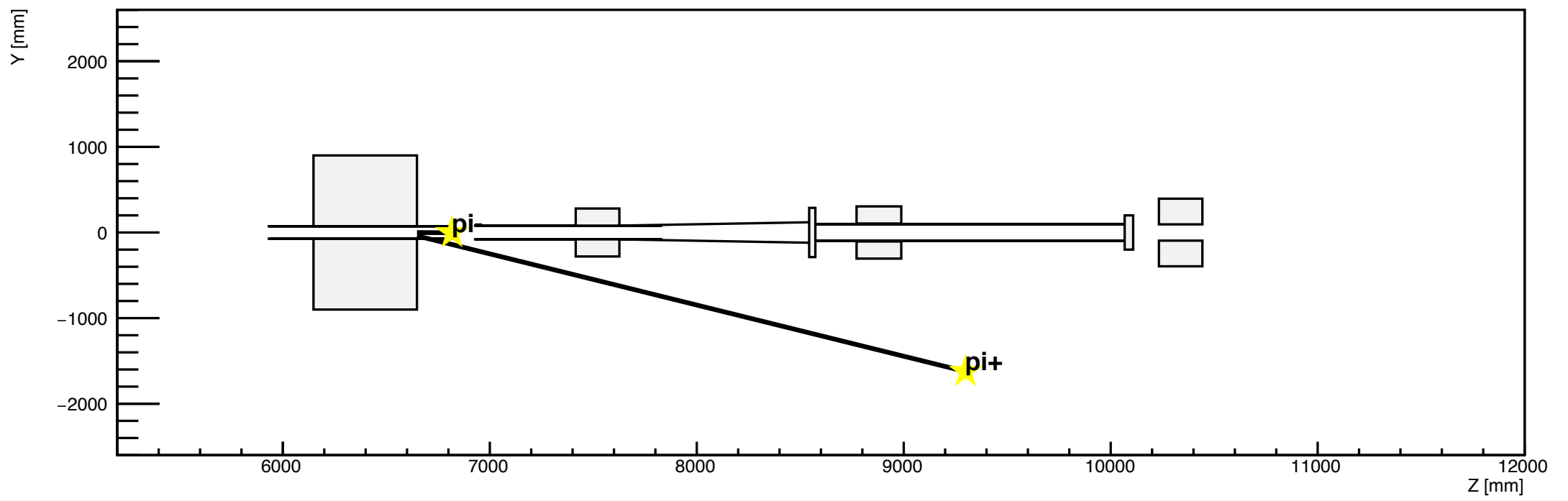

h2

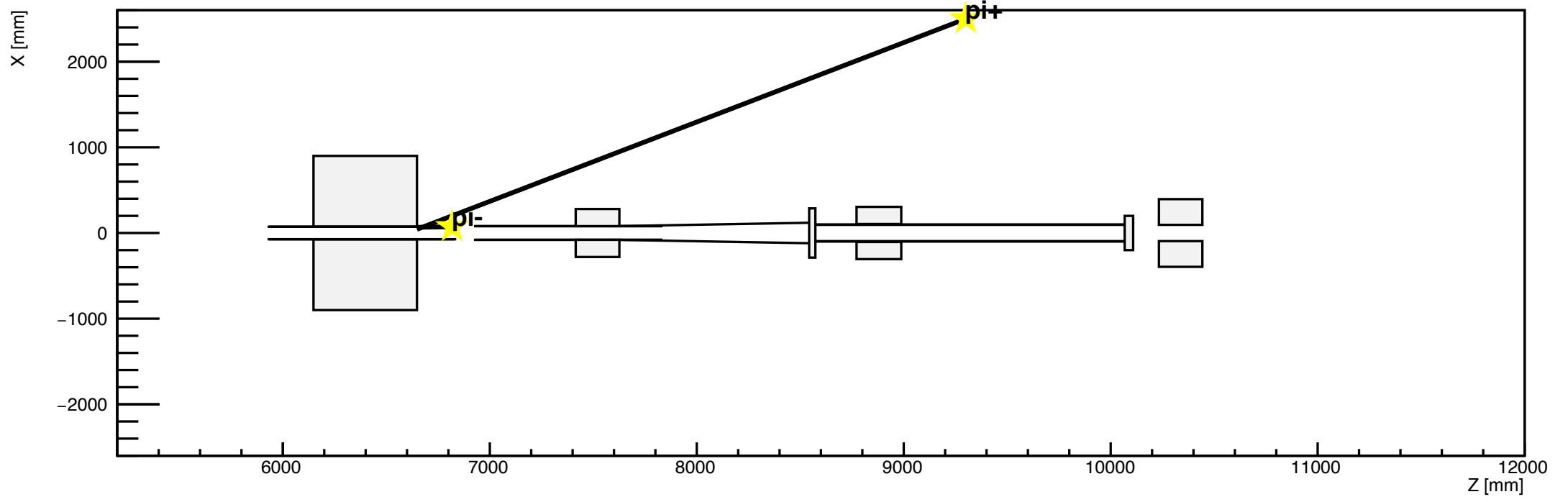

h1

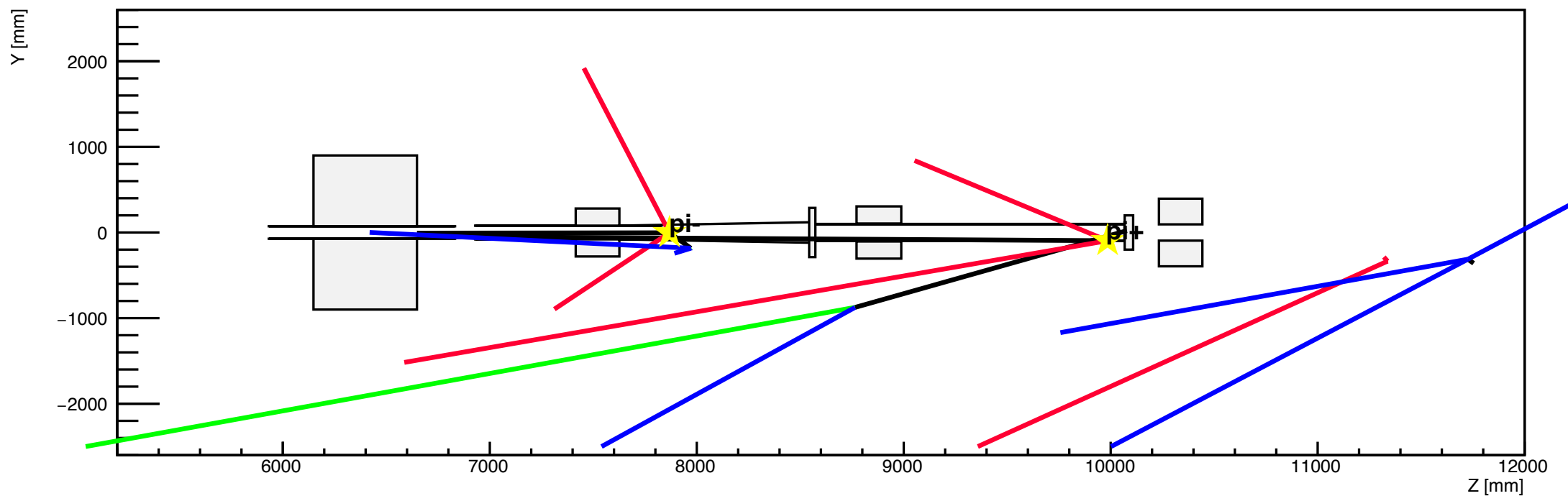

h2

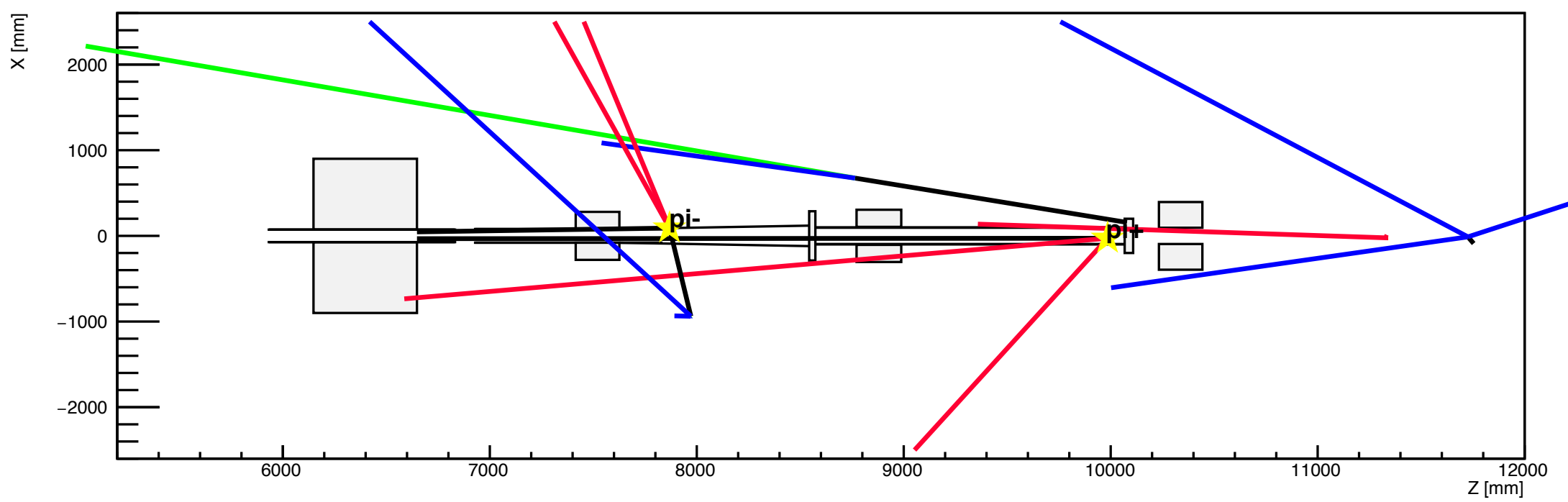

h1

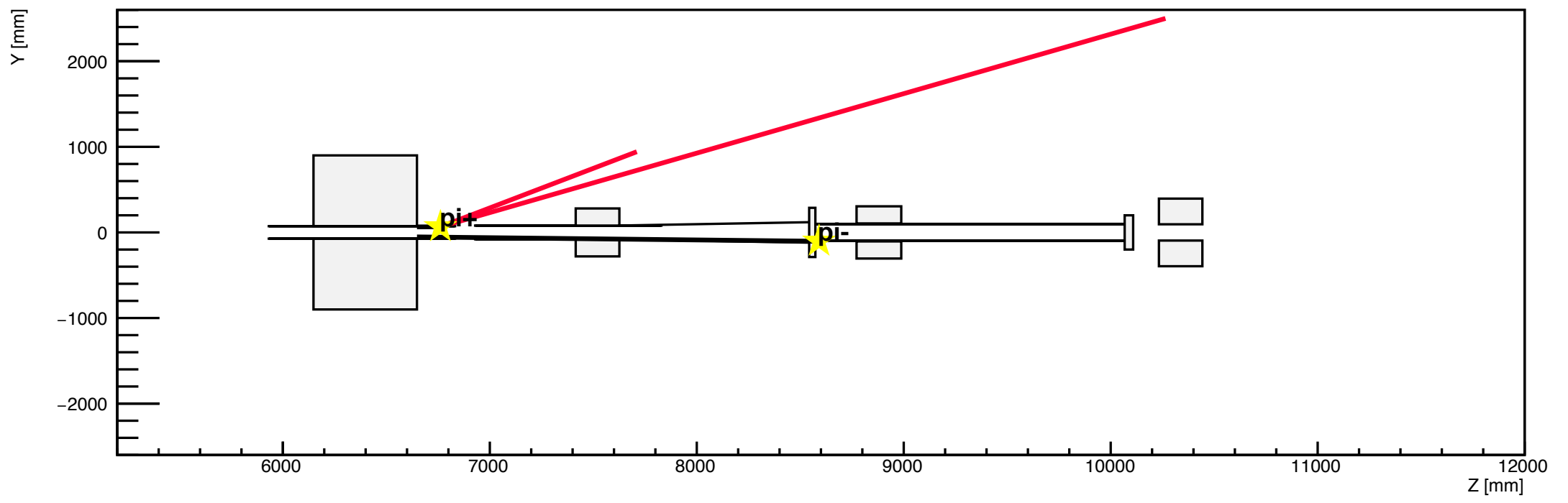

h2

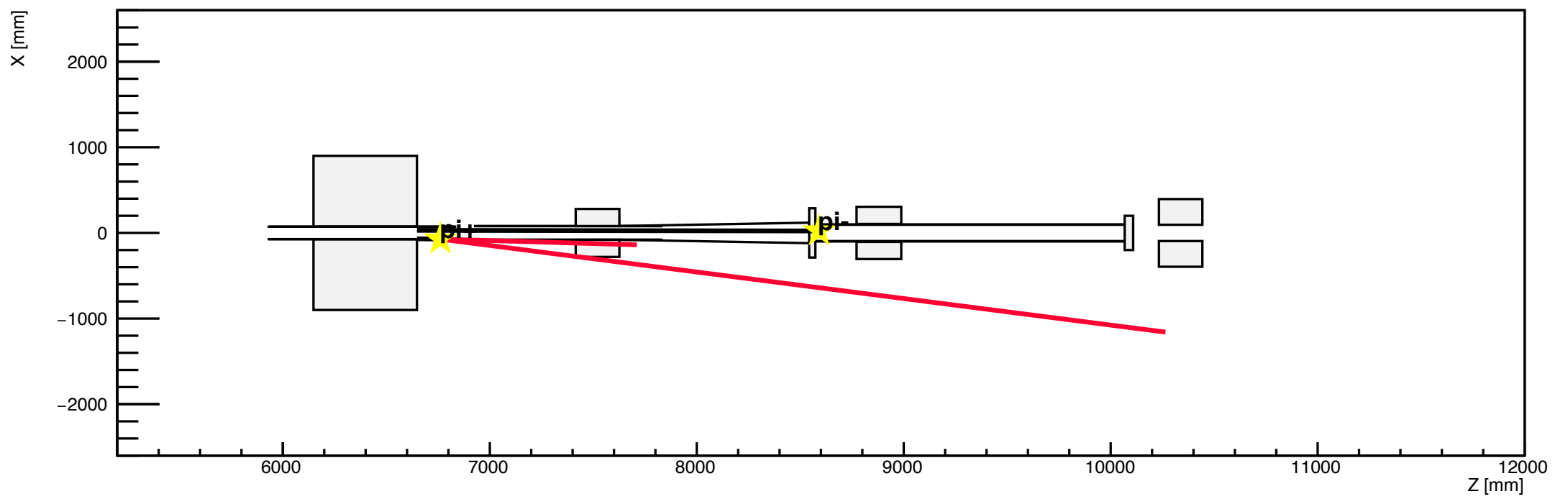

h1

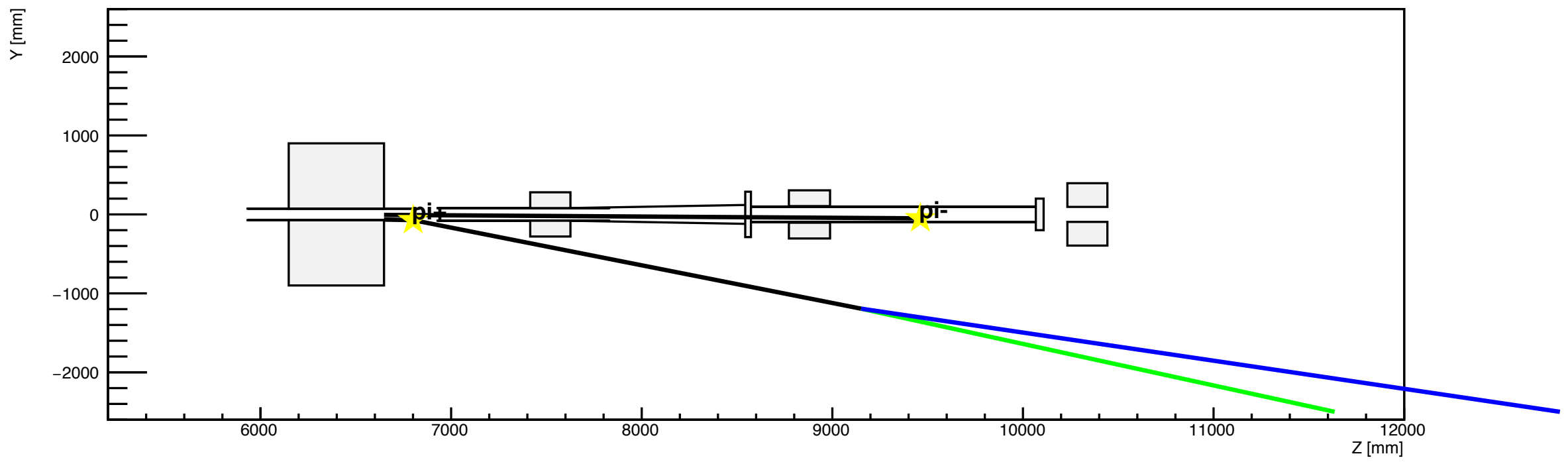

h2

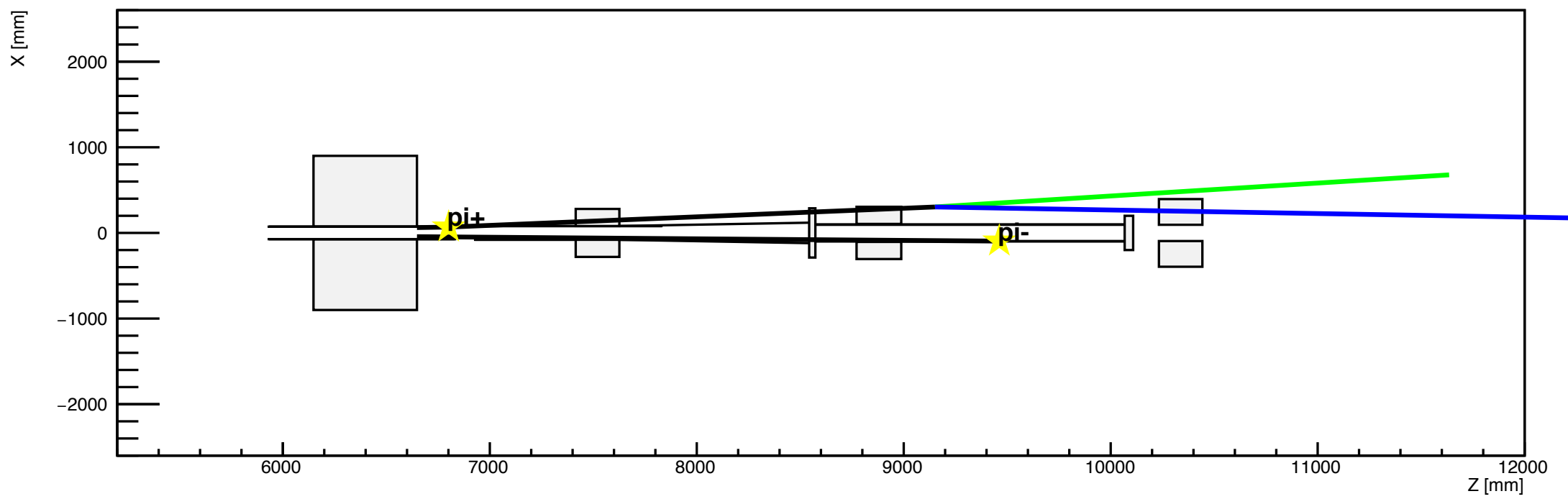

h1

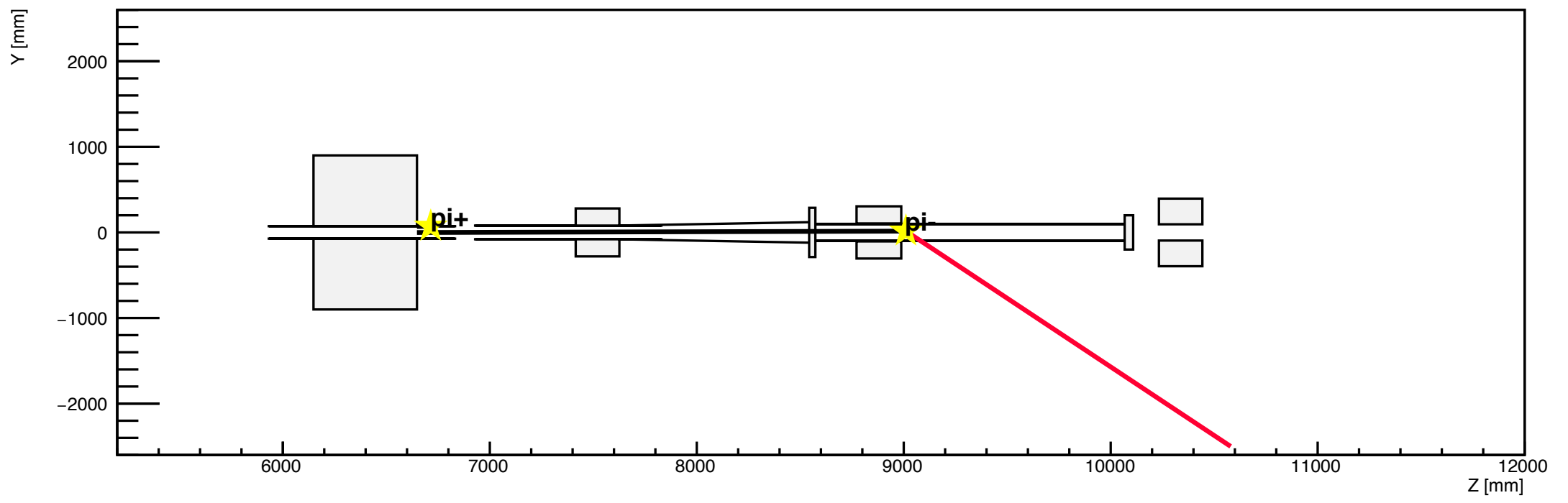

h2

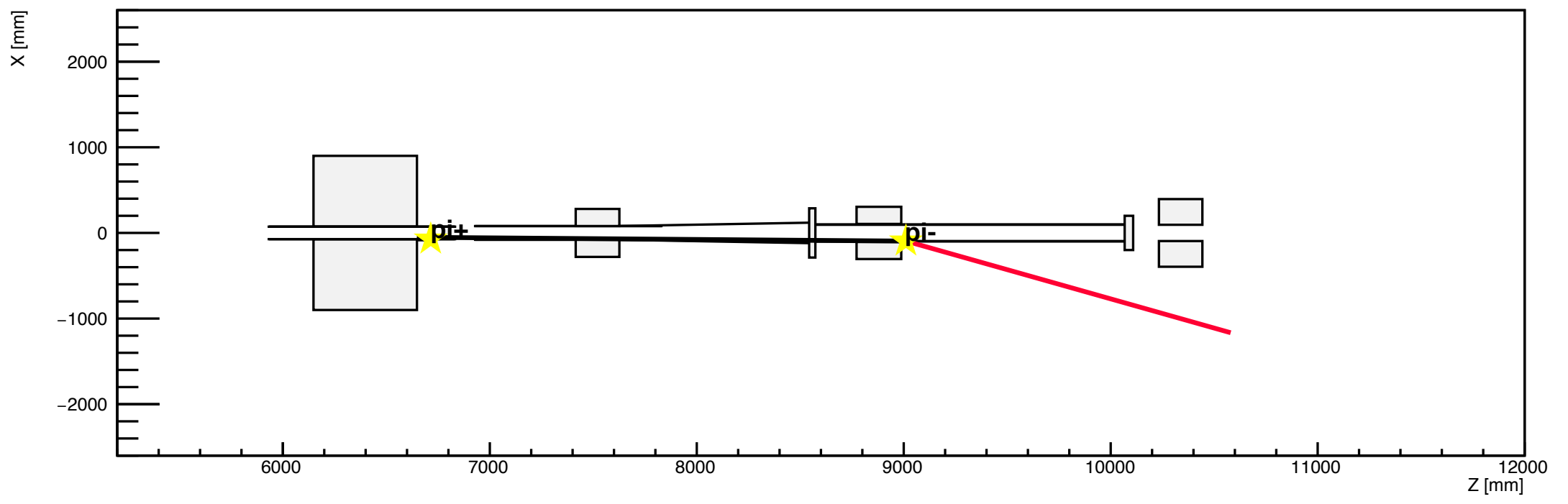

h1

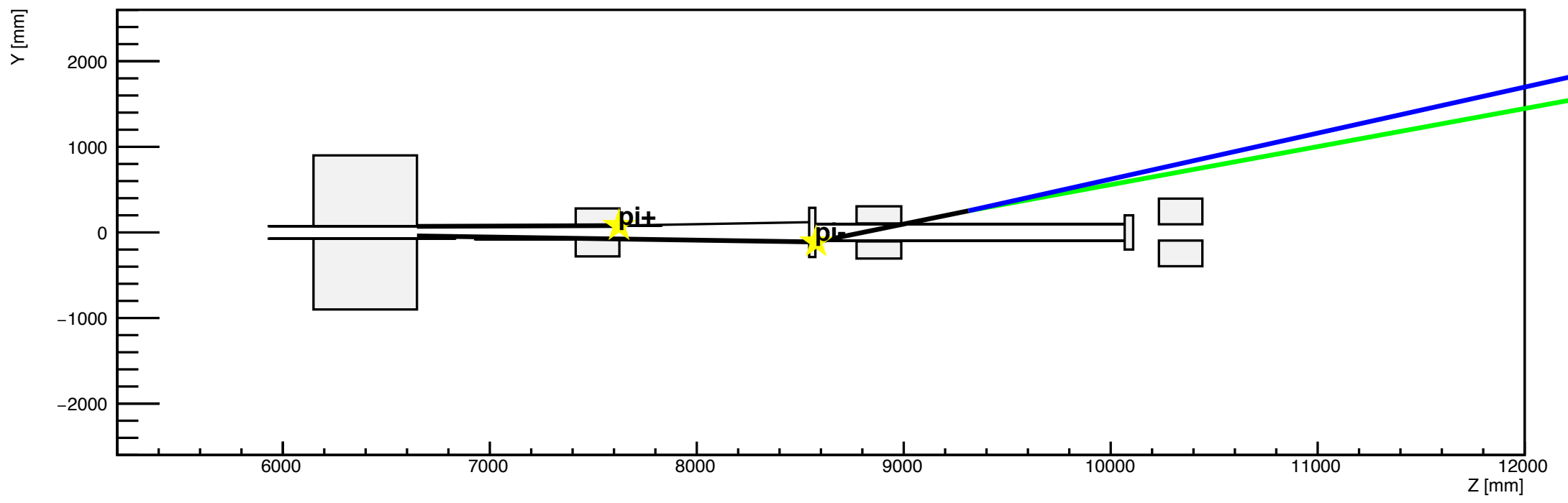

h2

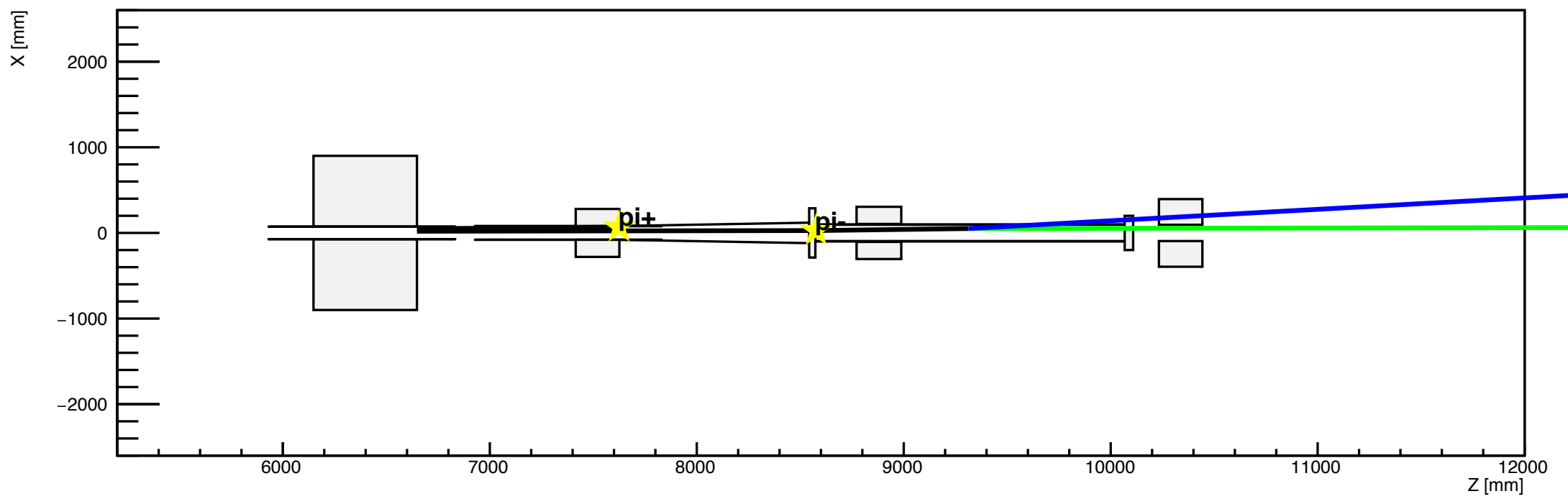

h1

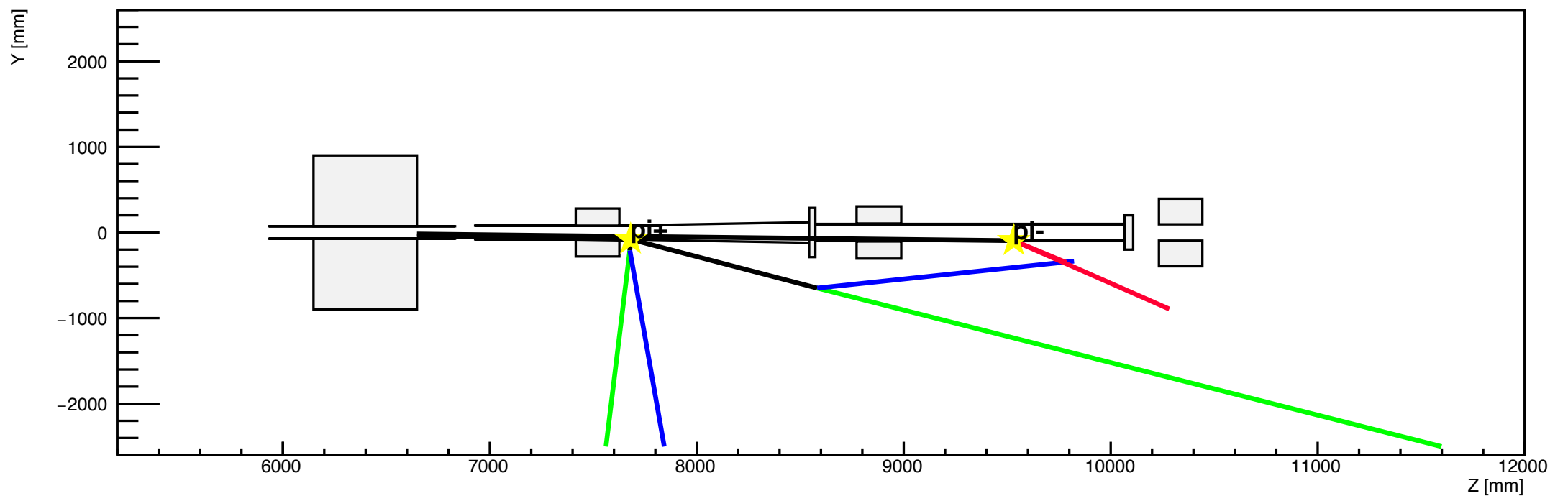

h2

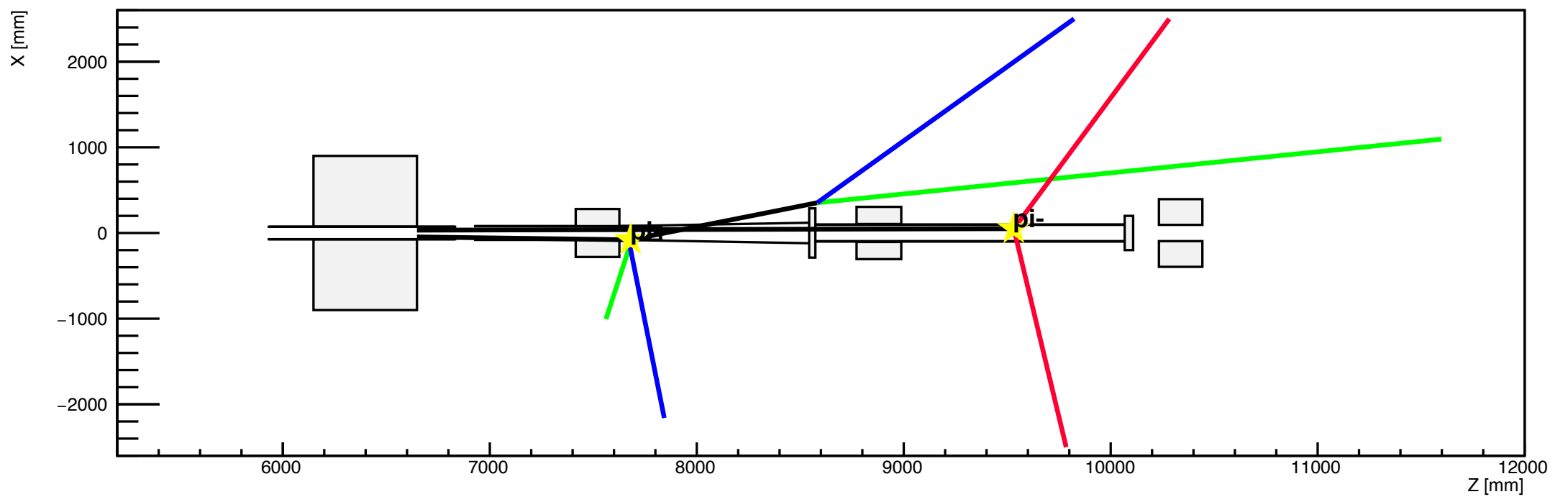

h1

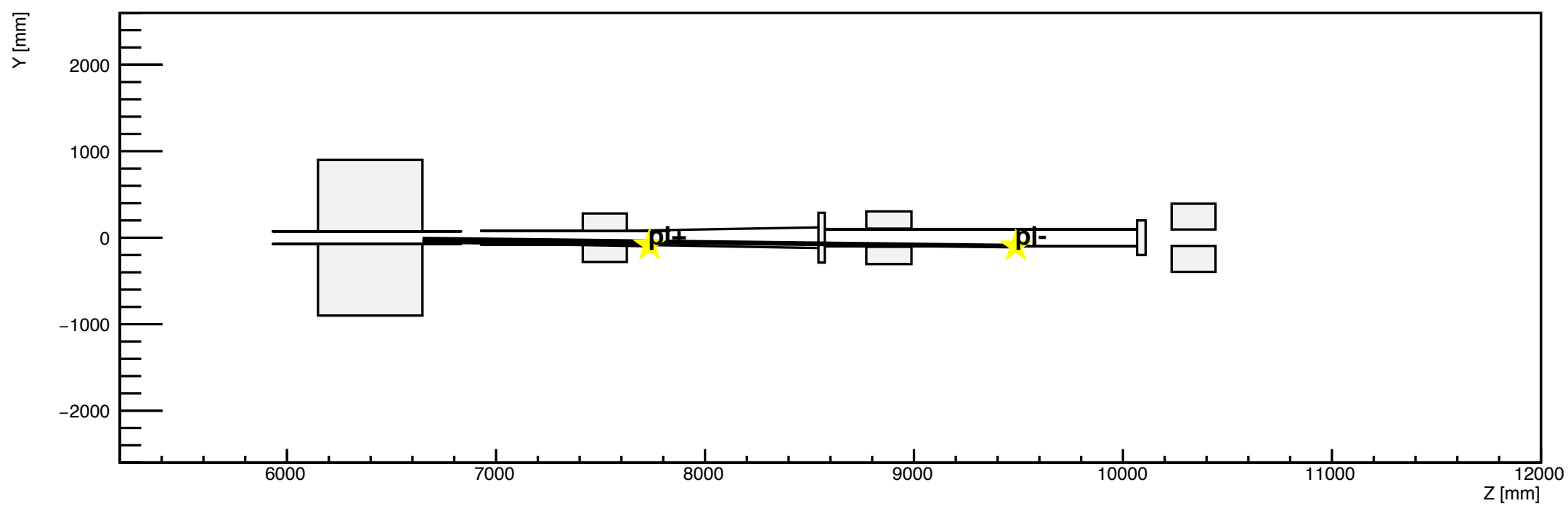

h2

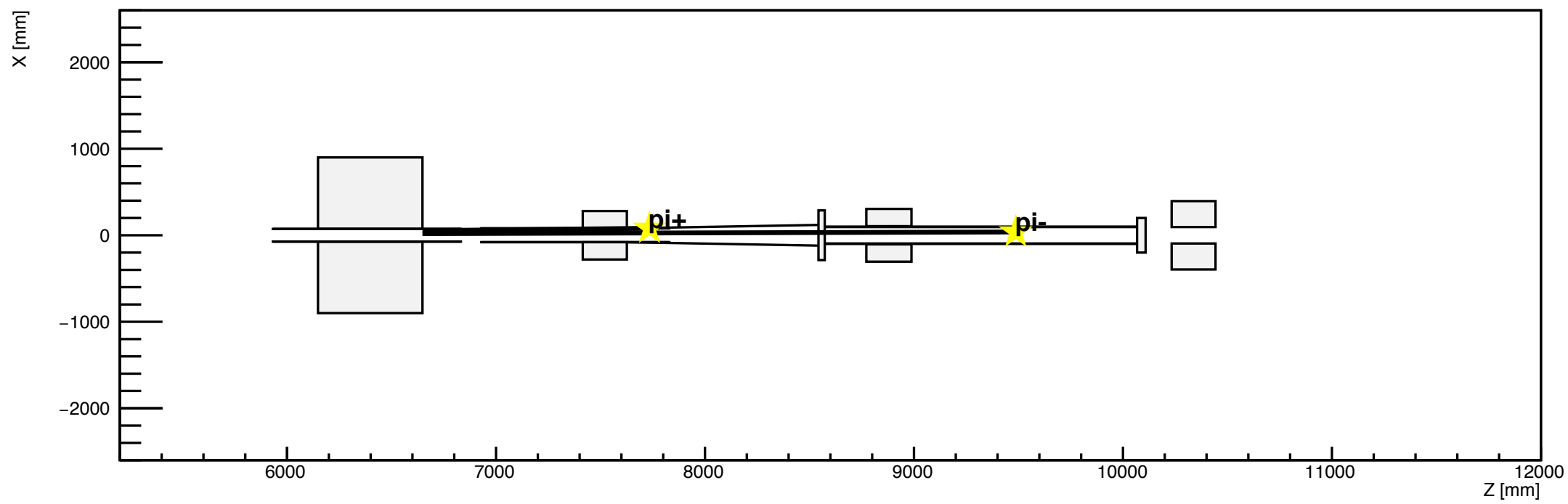

h1

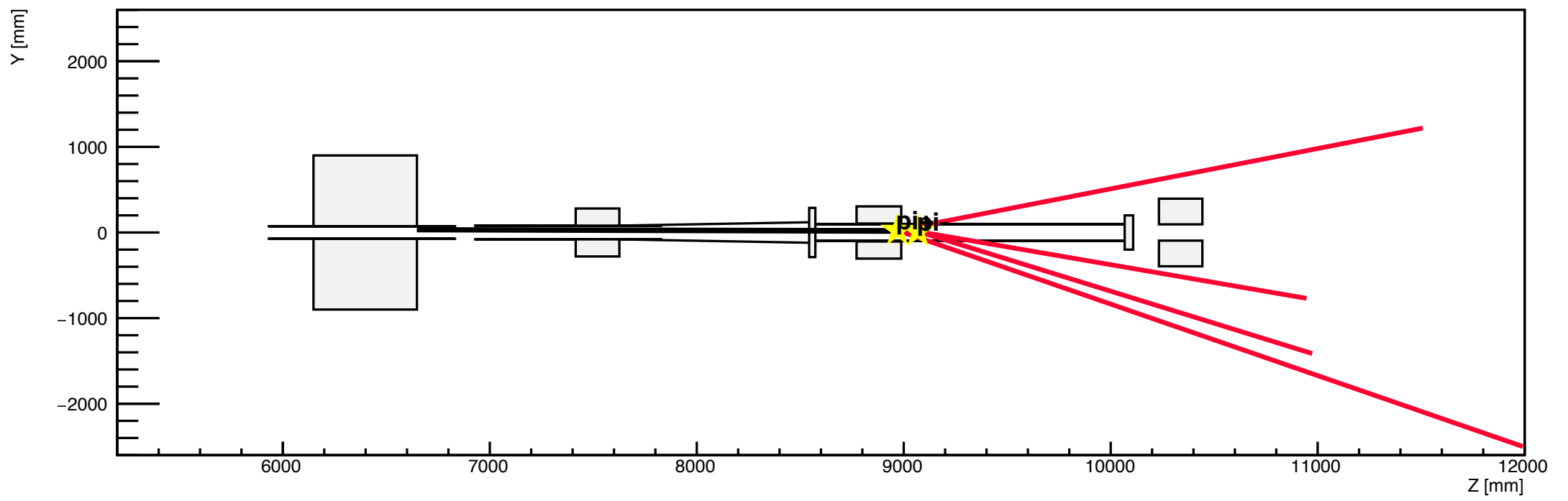

h2

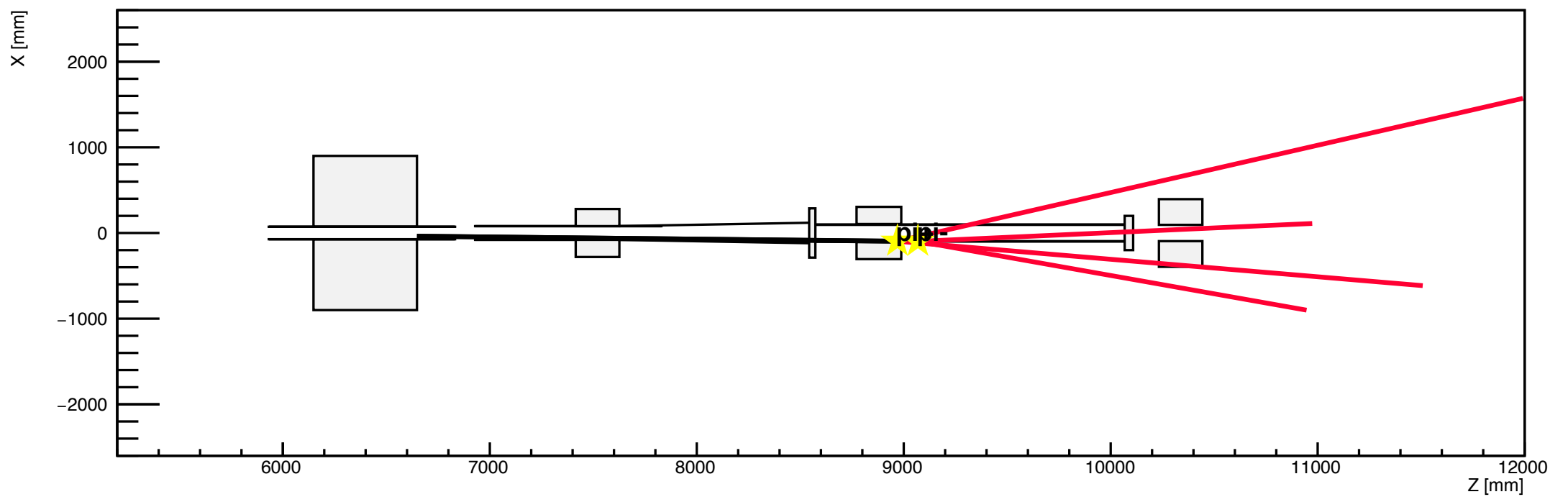

h1

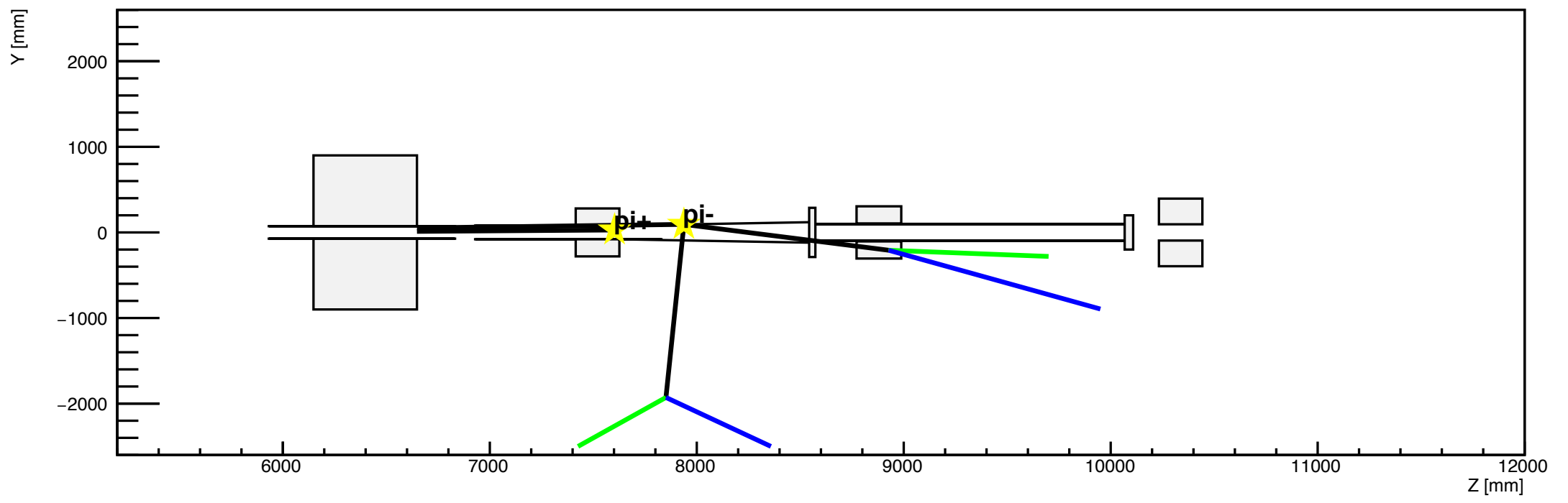

h2

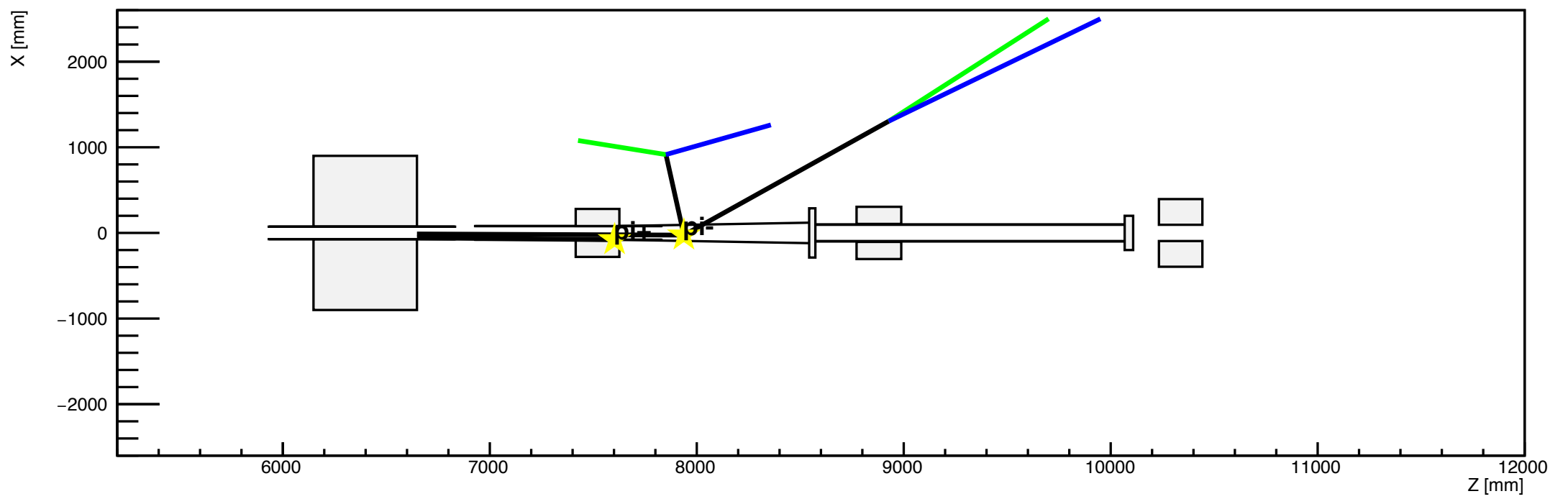

h1

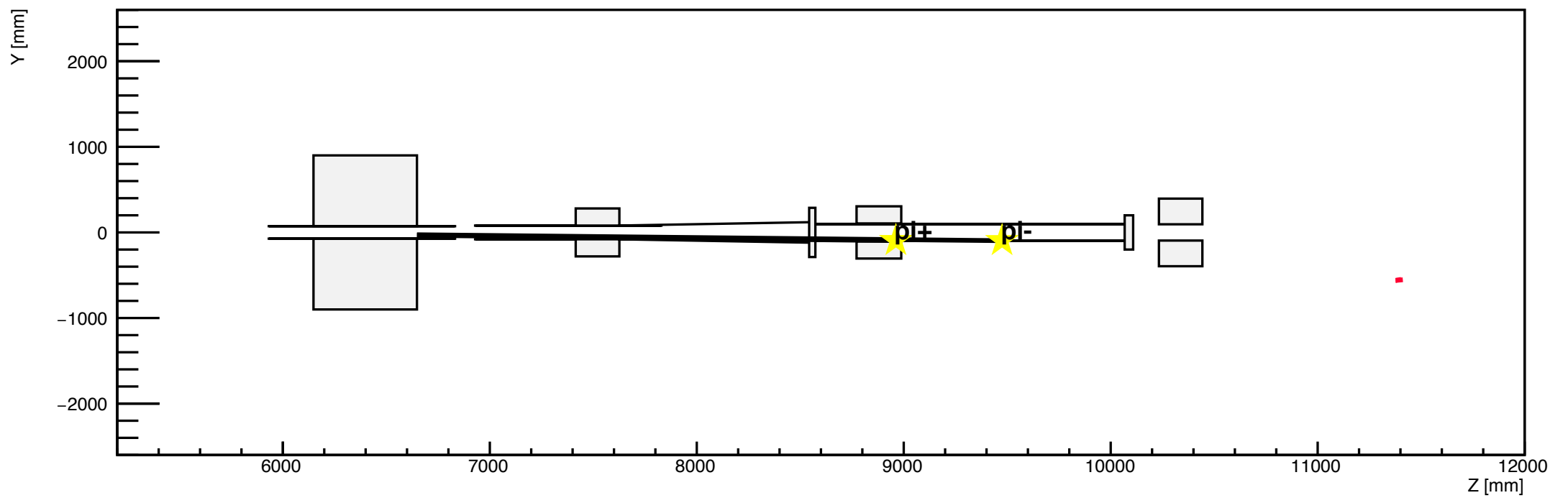

h2

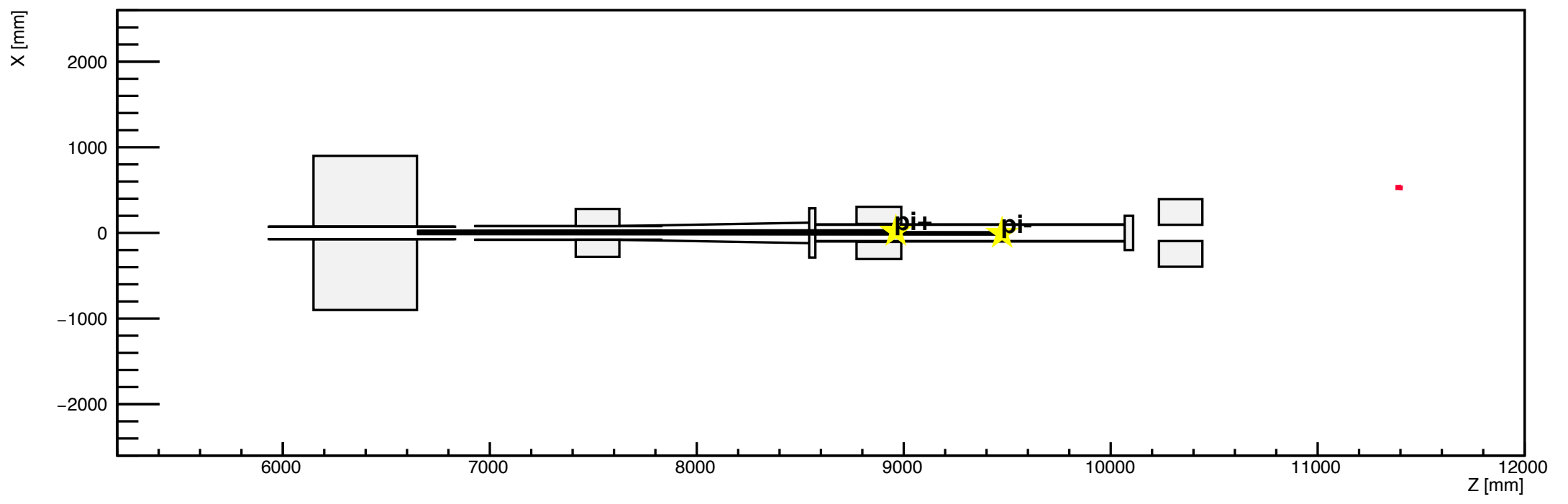

h1

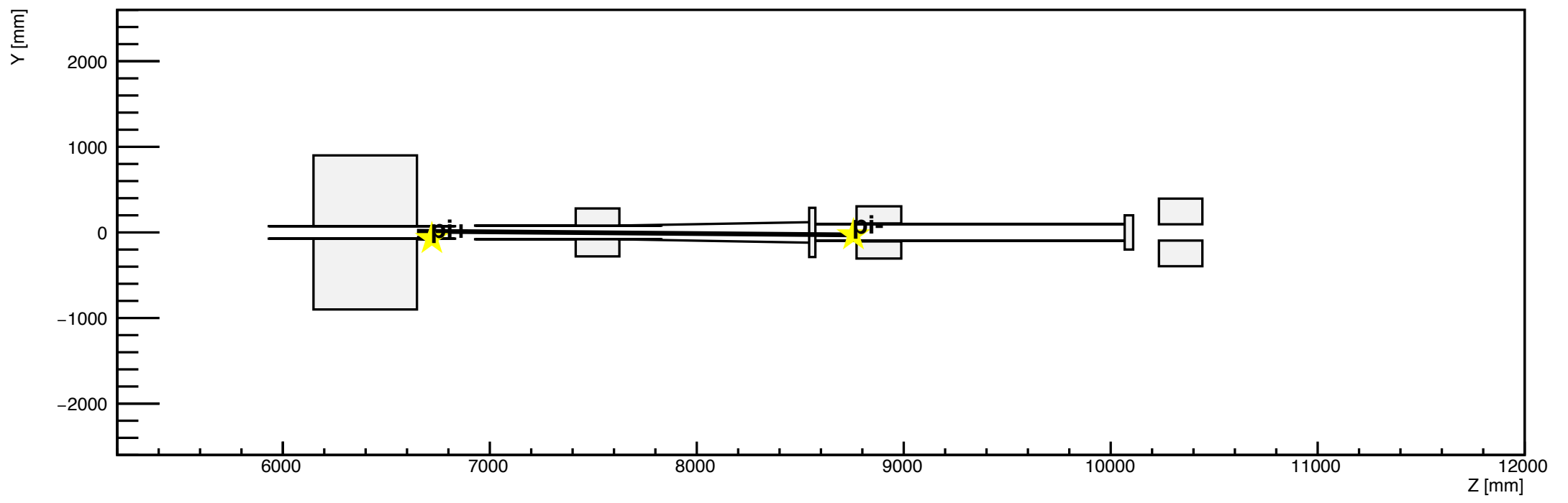

h2

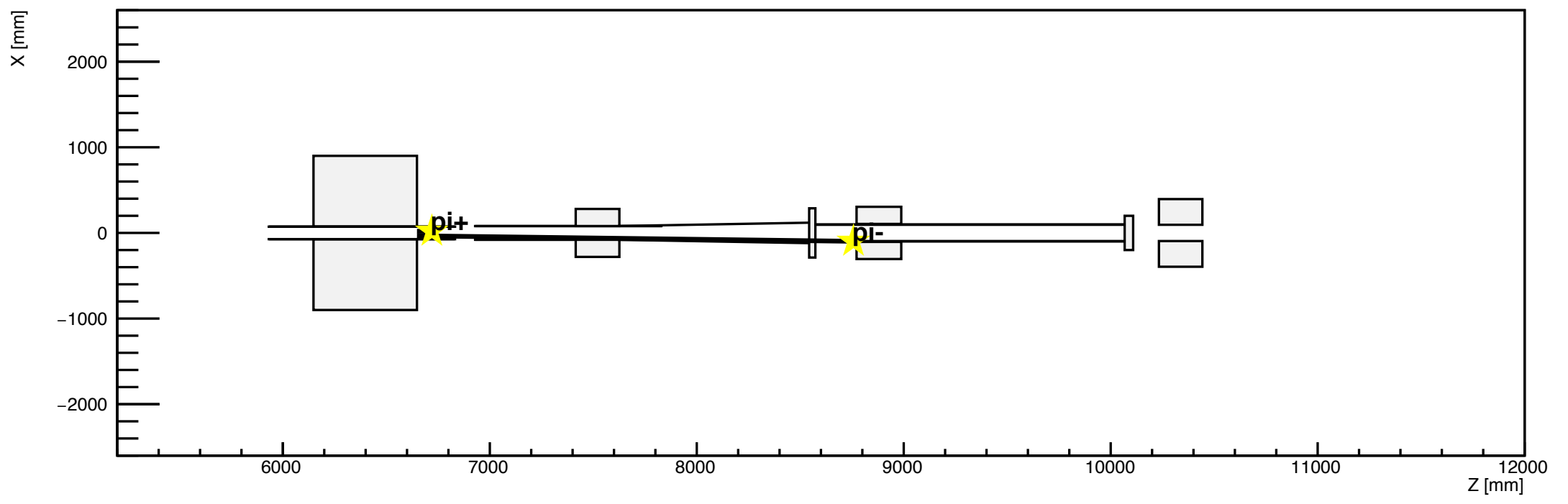

h1

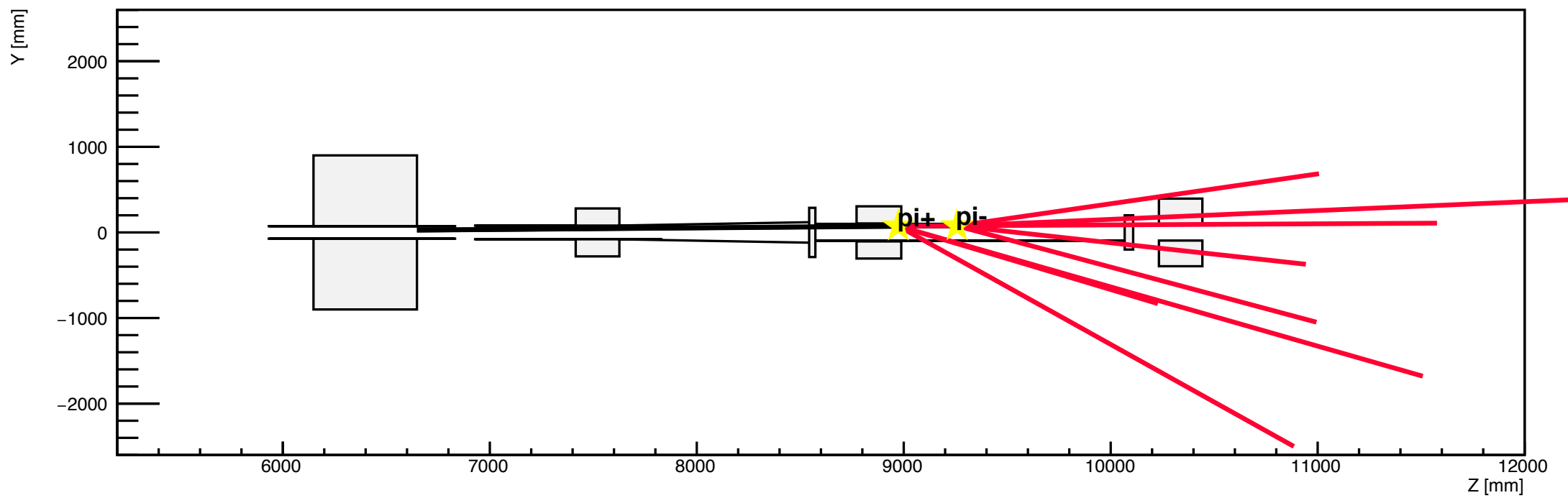

h2

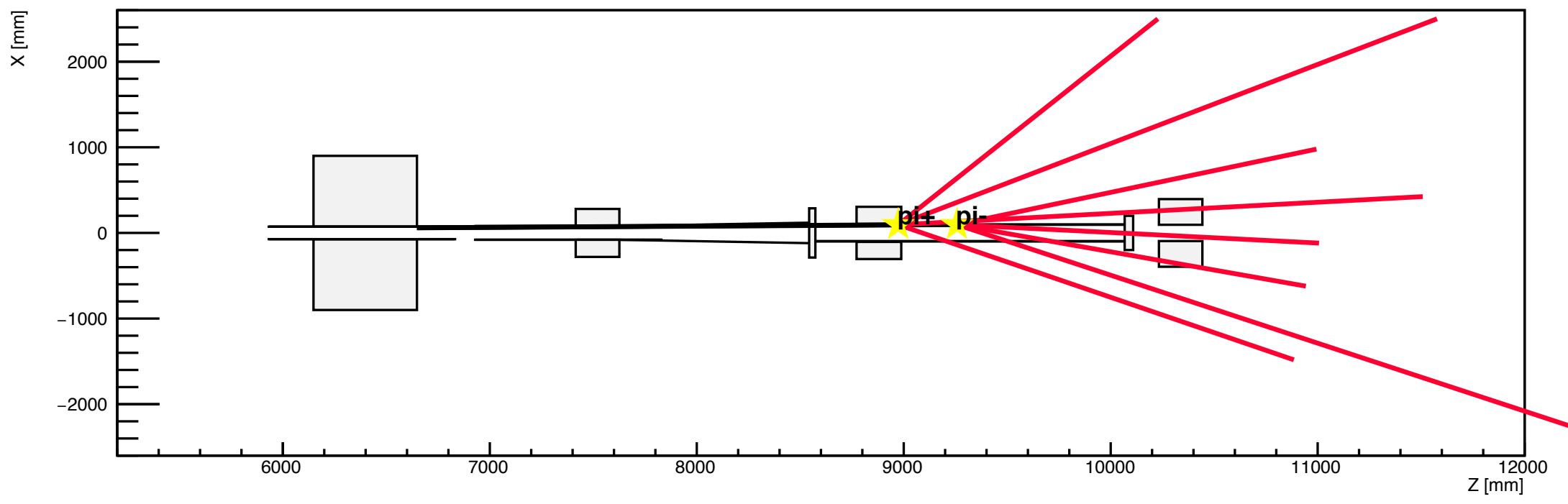

h1

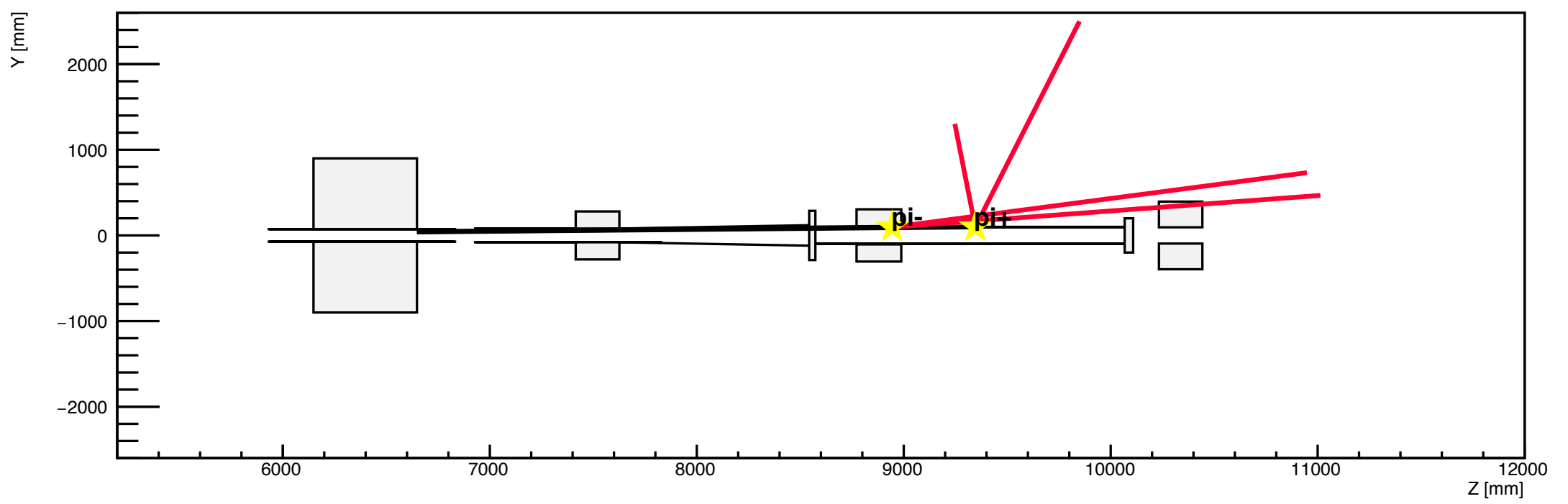

h2

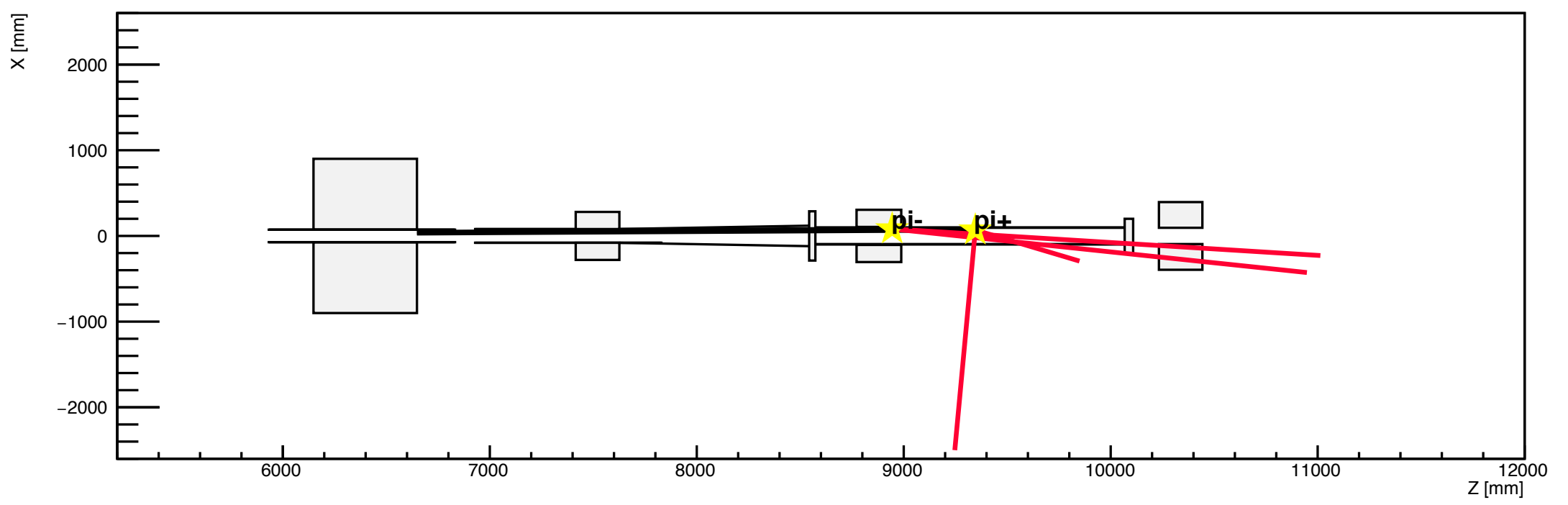

h1

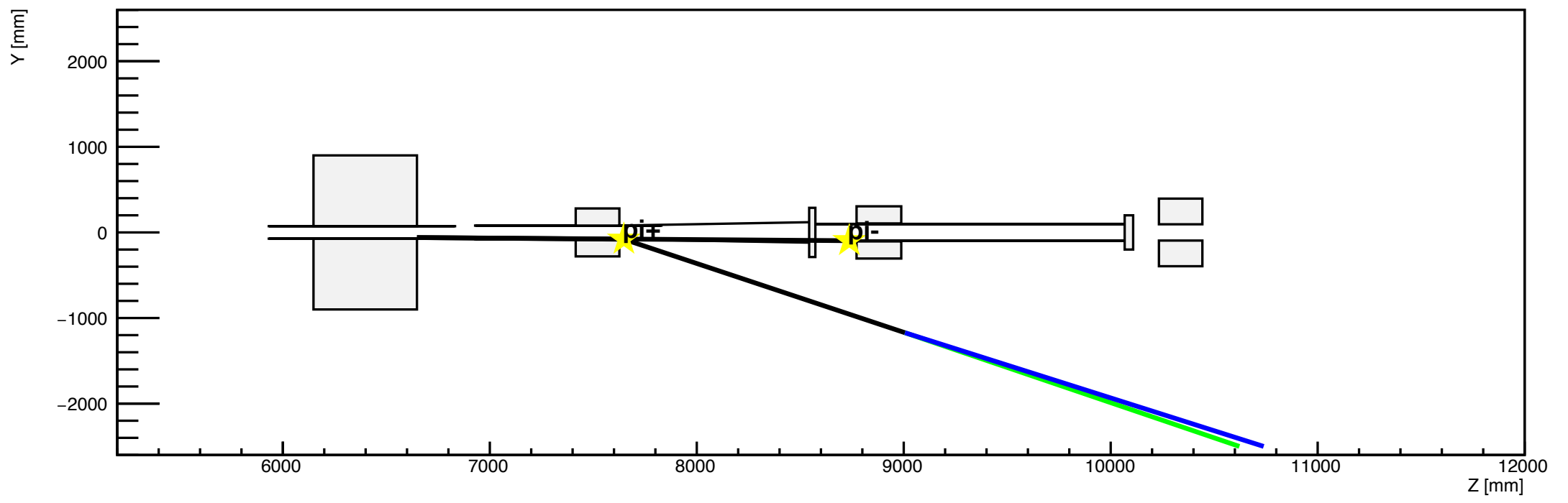

h2

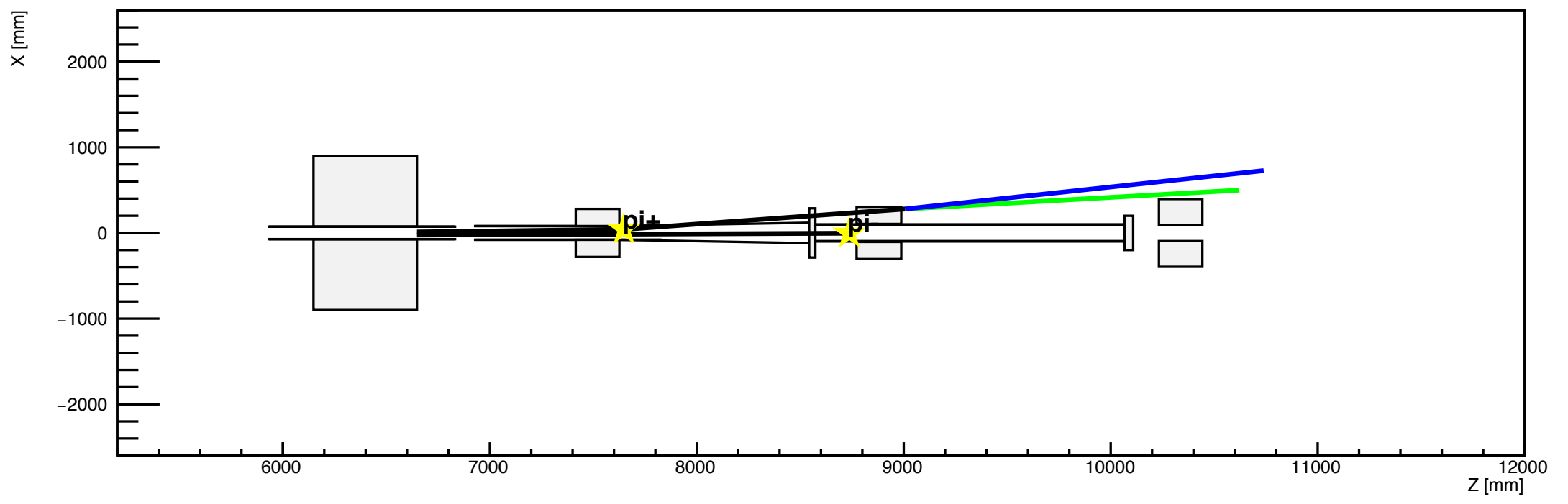

h1

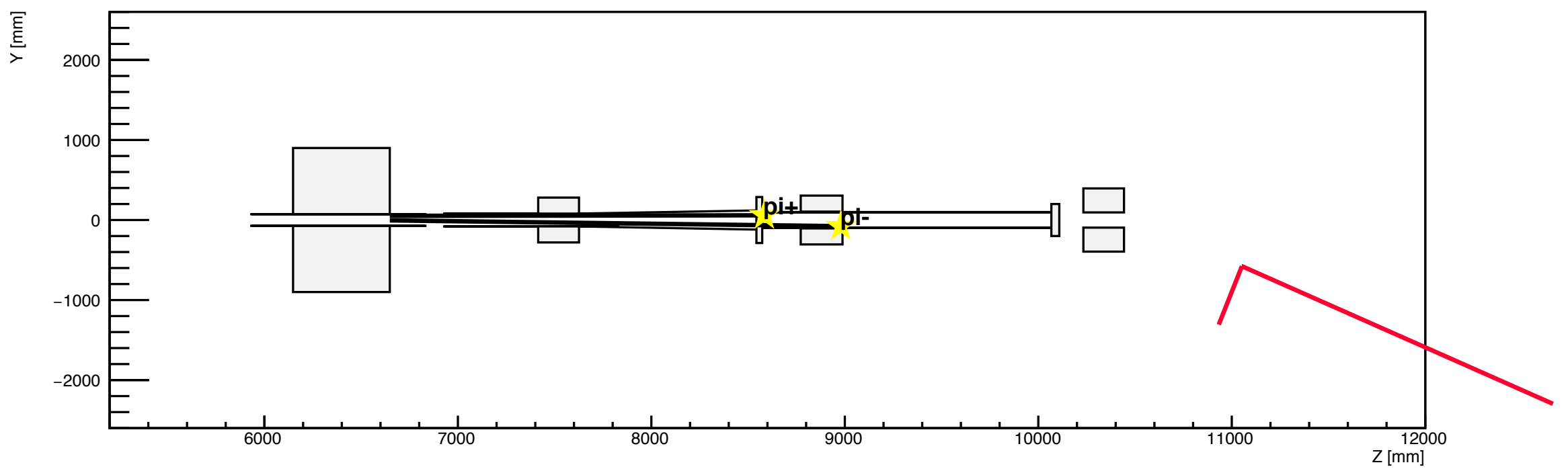

h2

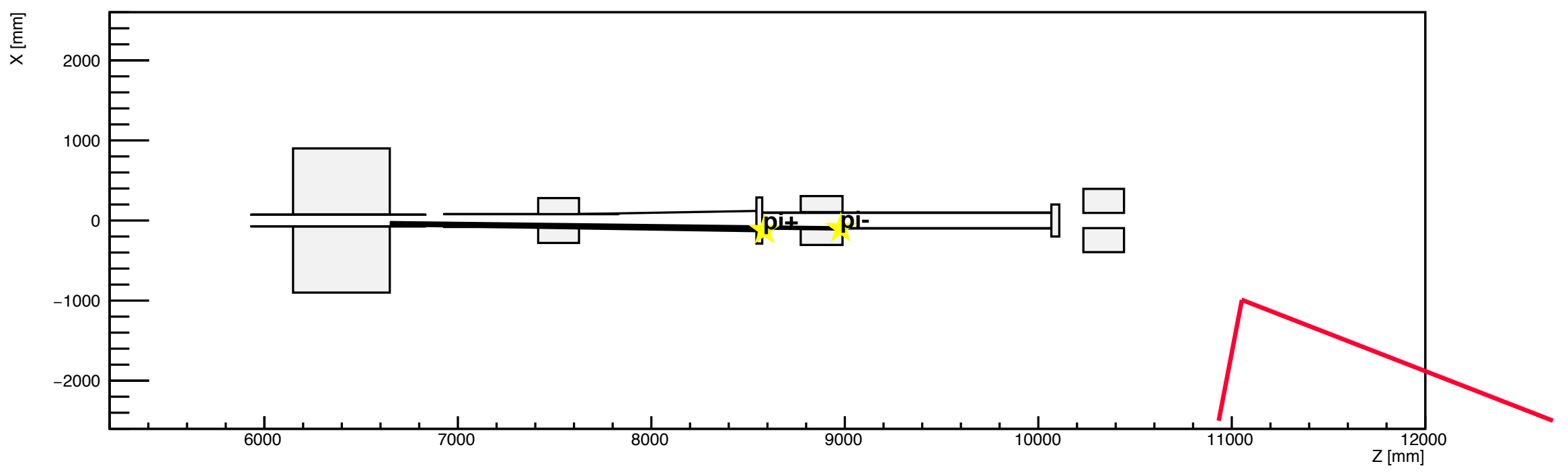

h1

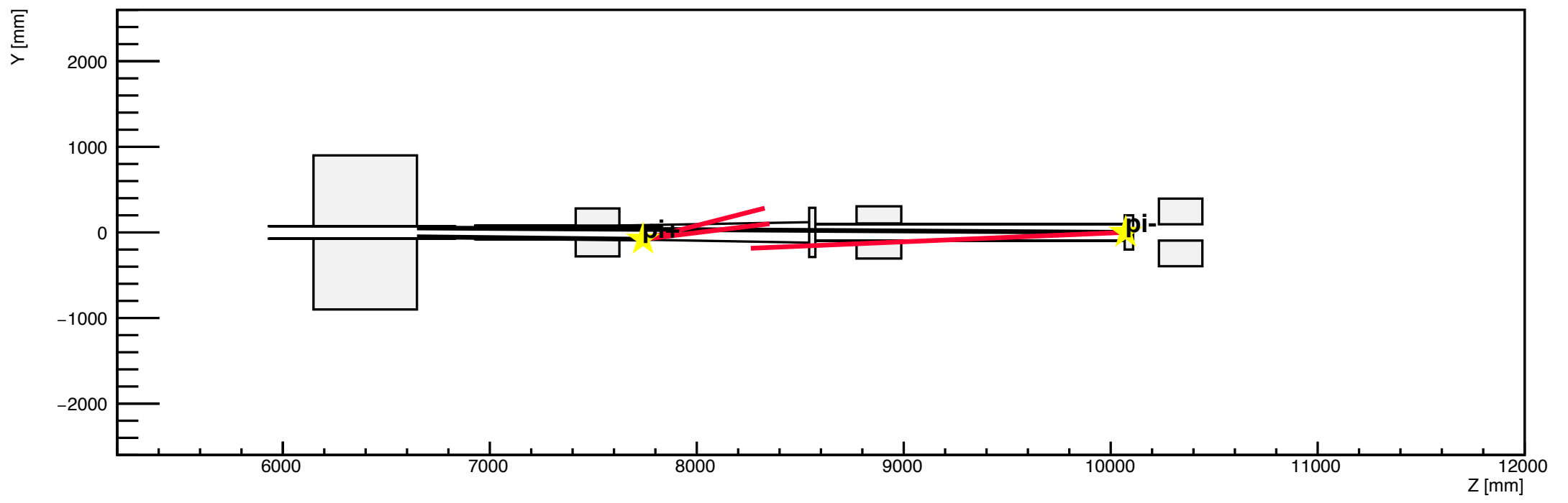

h2

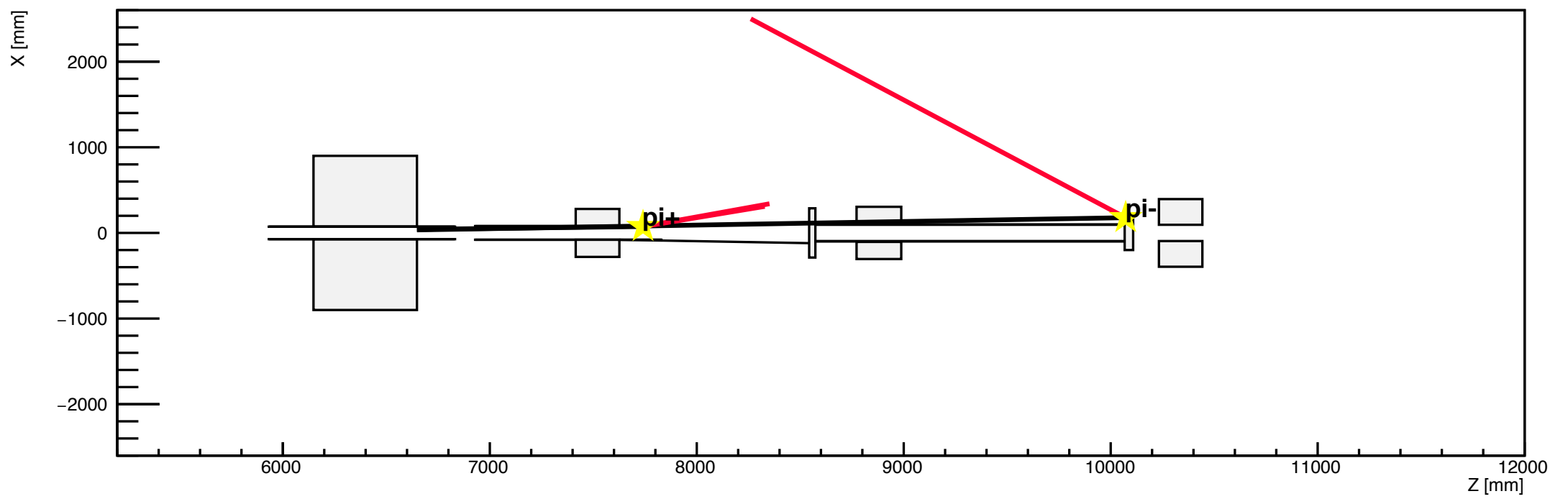

h1

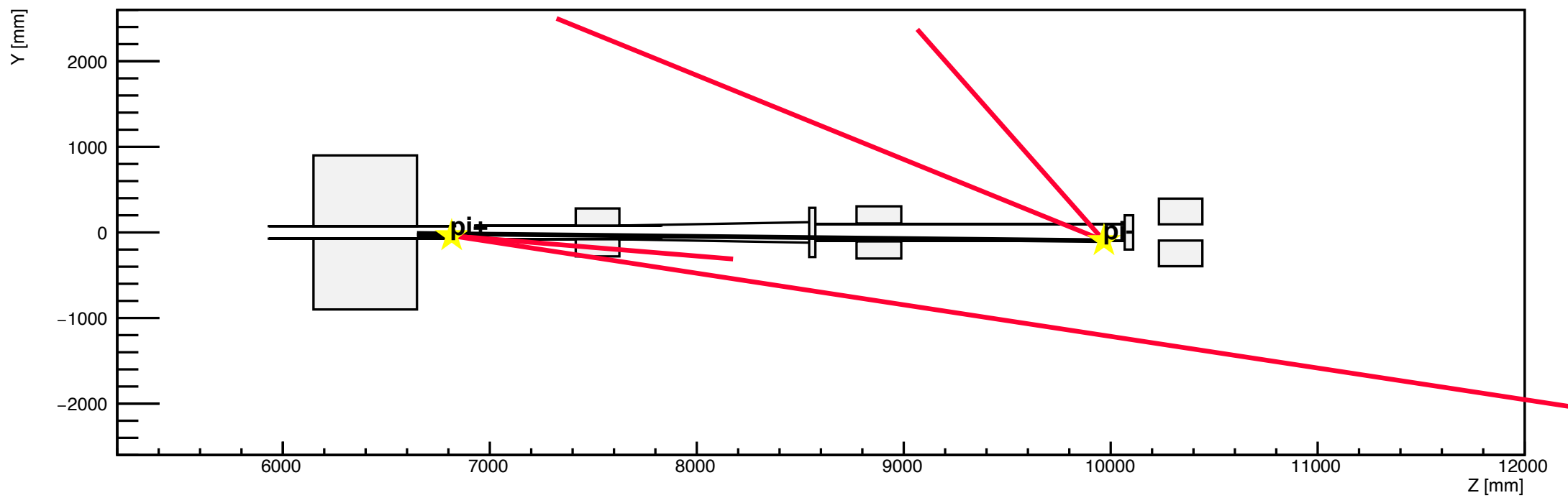

h2

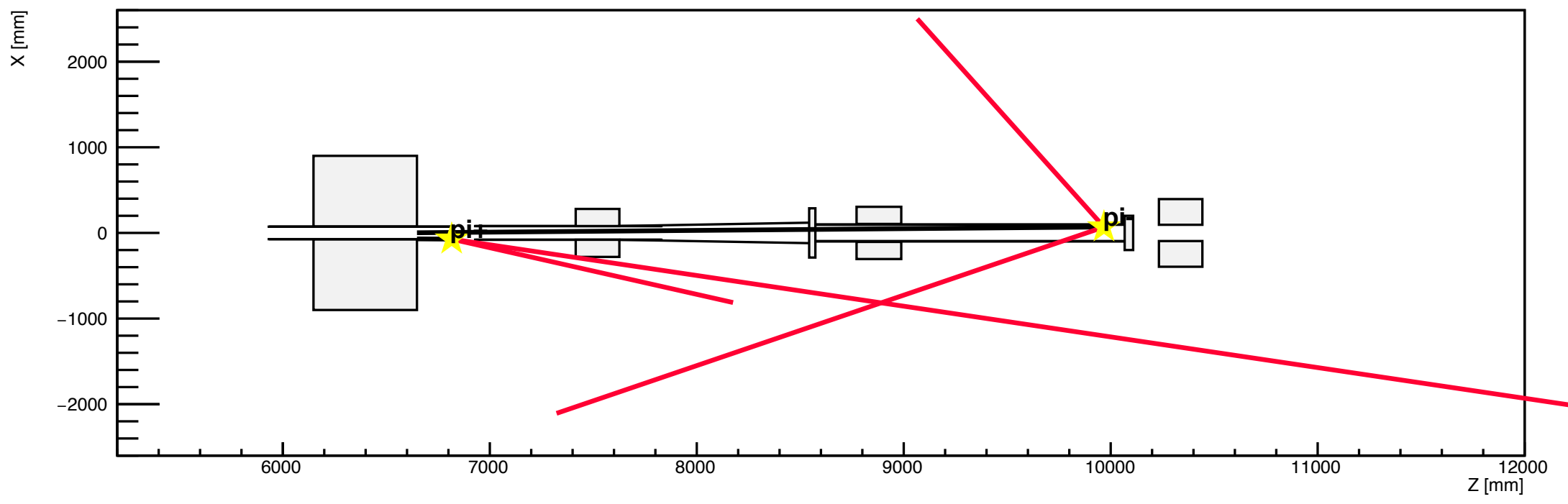

h1

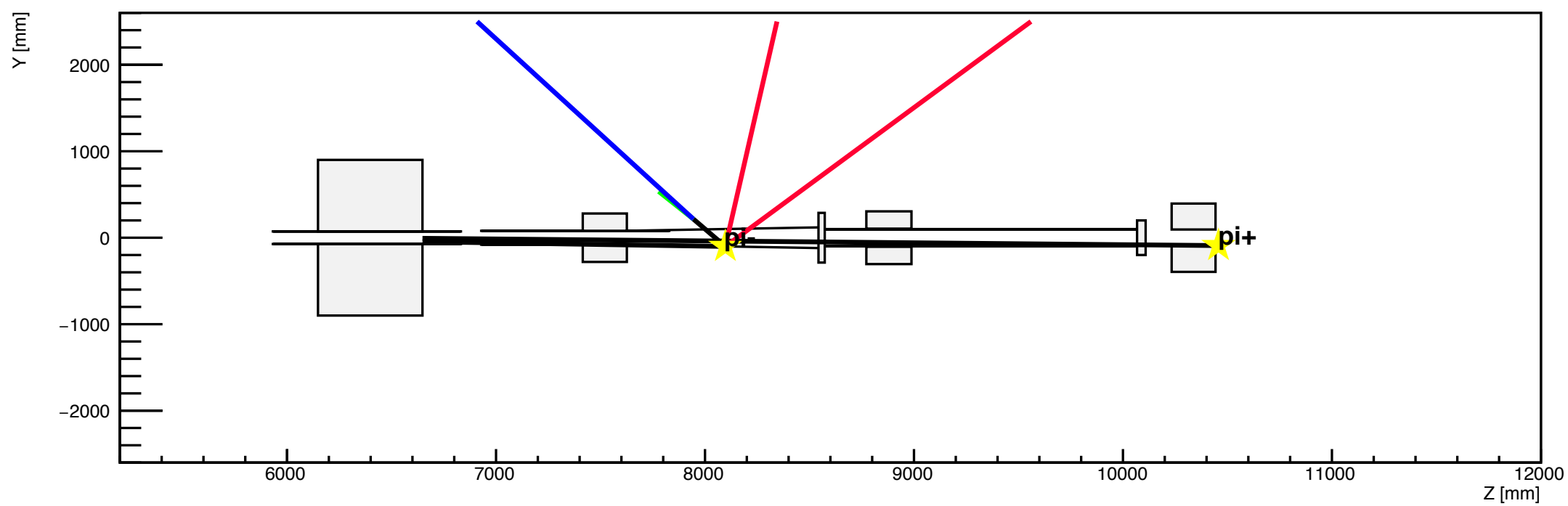

h2

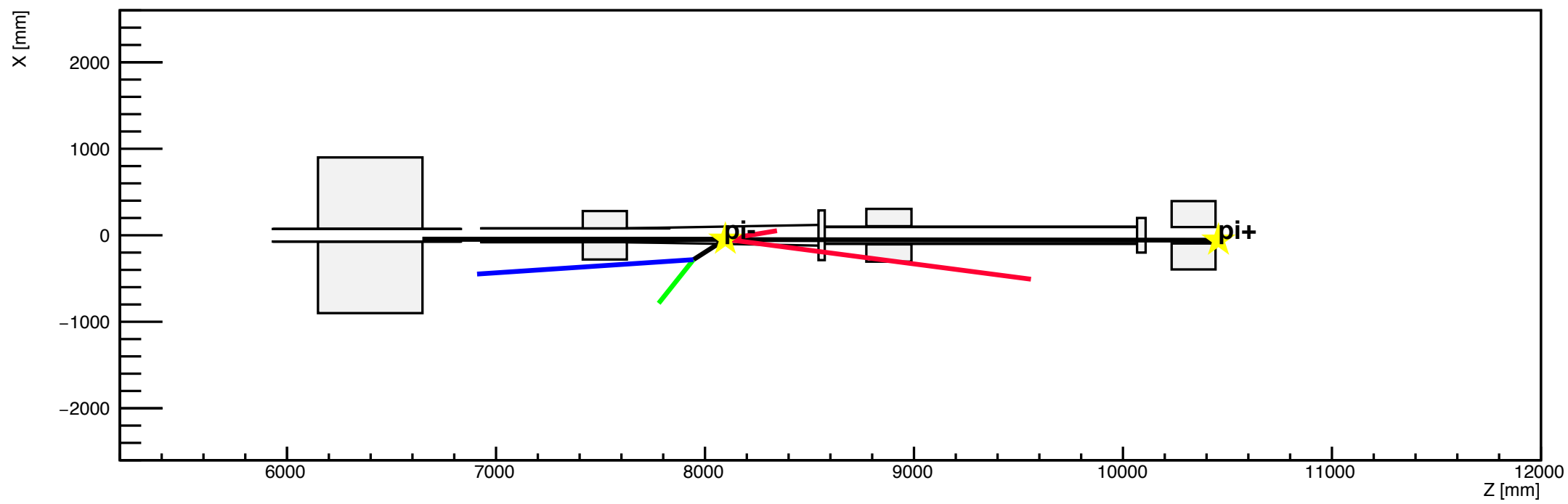

h1

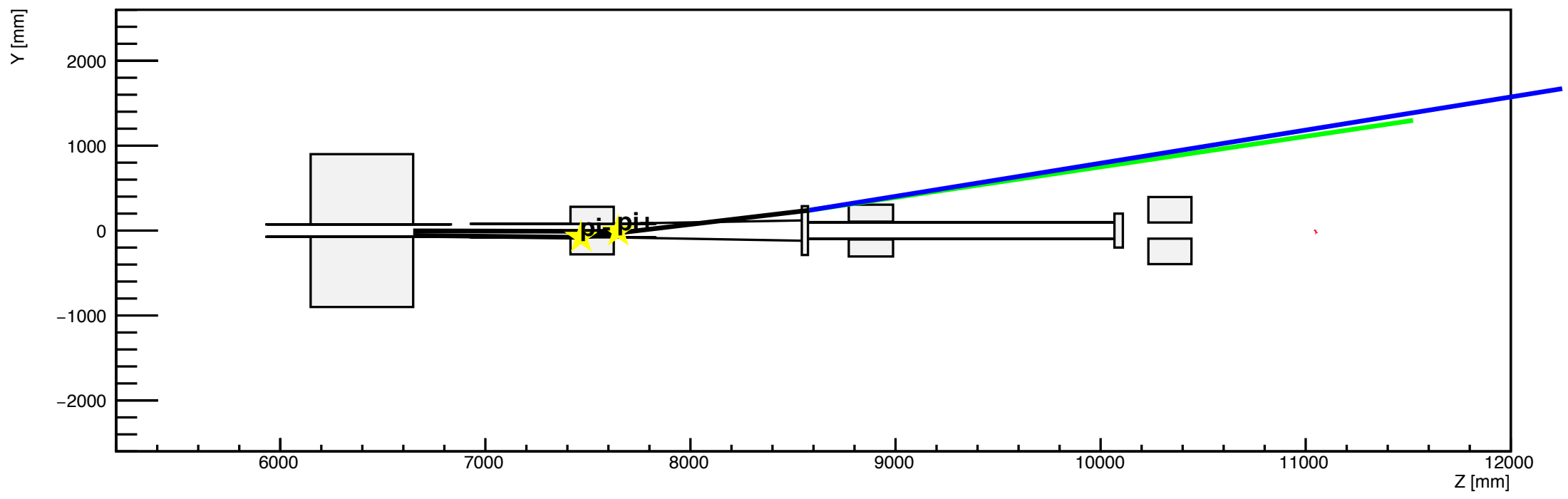

h2

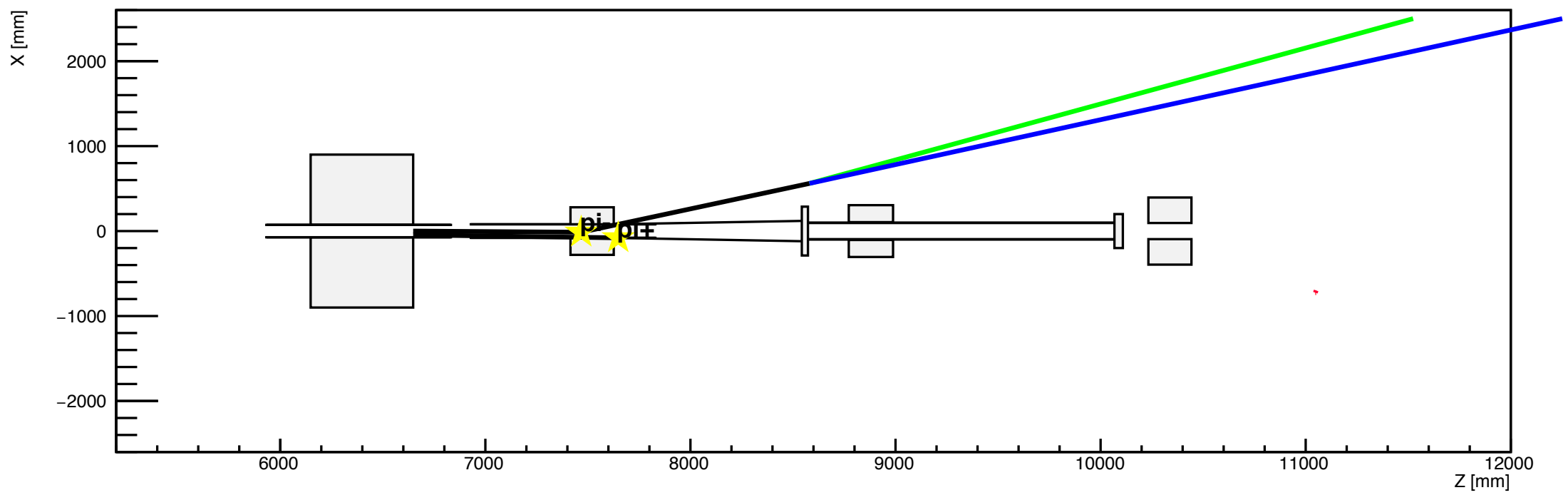

h1

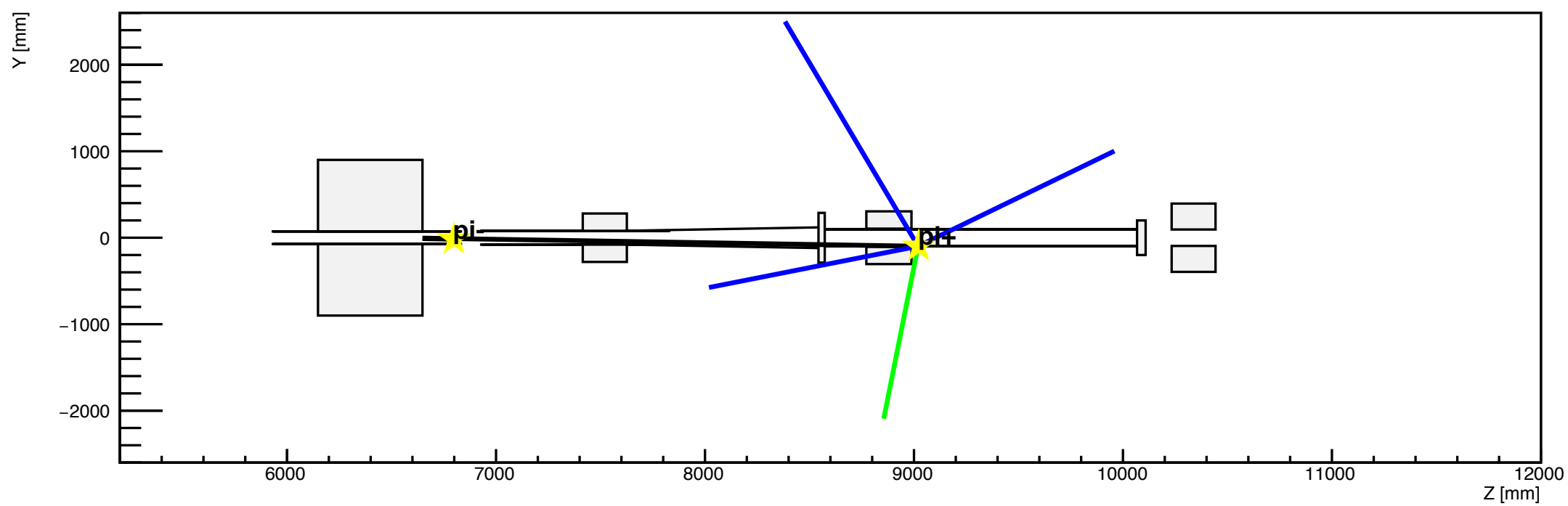

h2

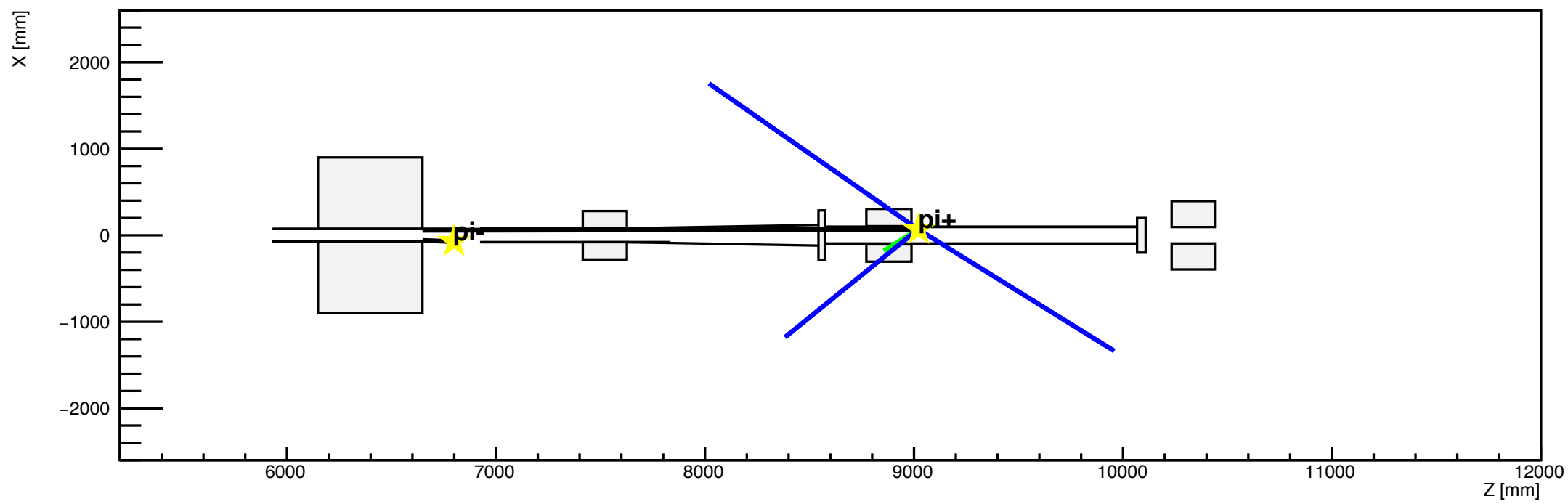

h1

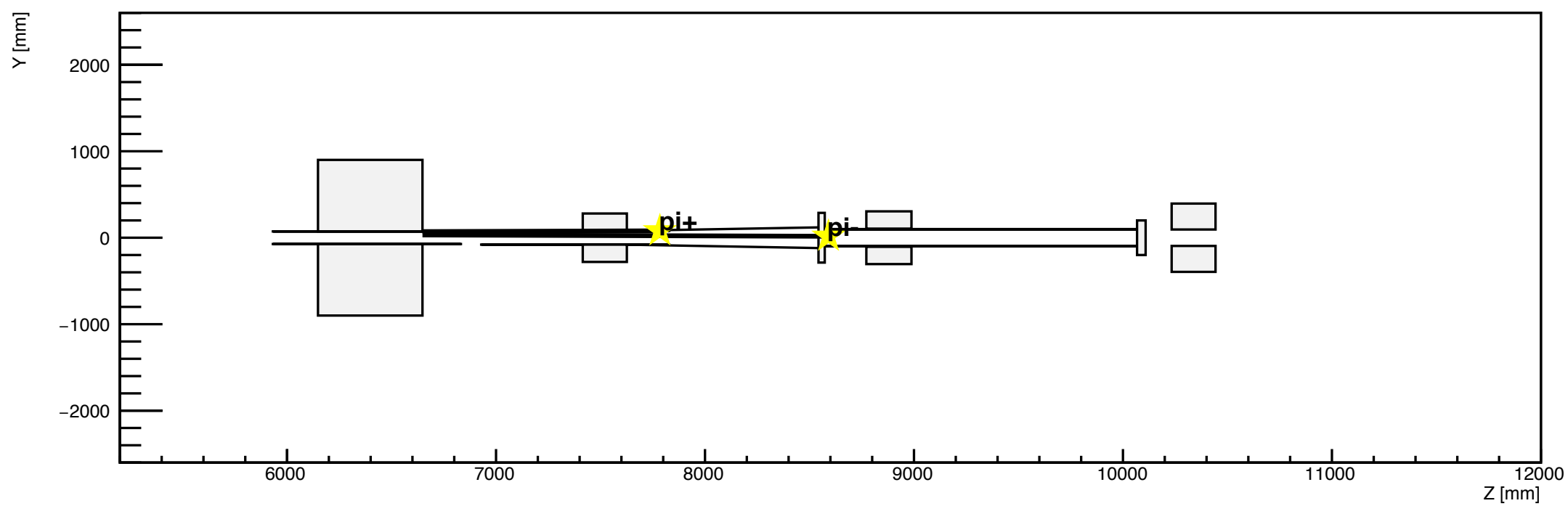

h2

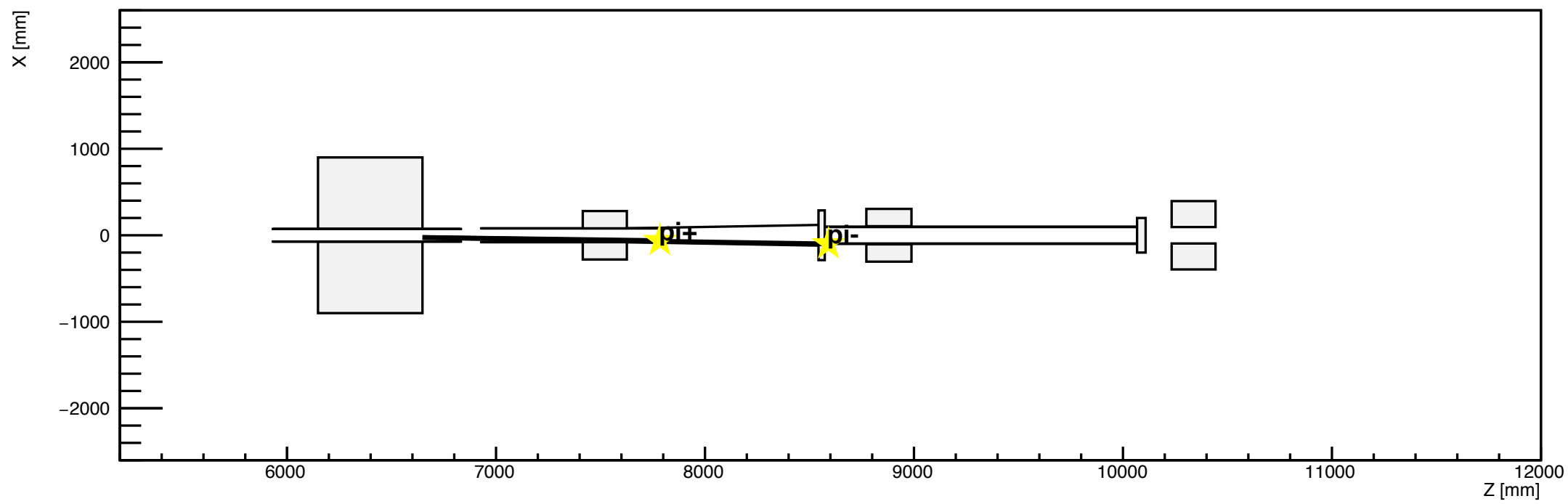

h1

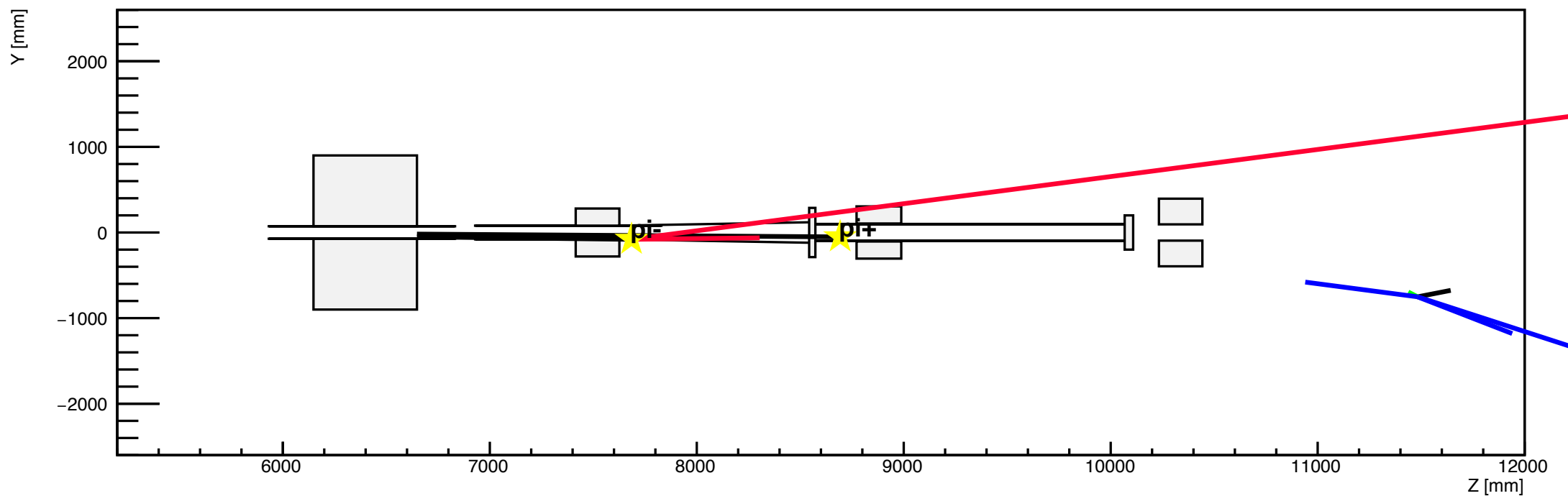

h2

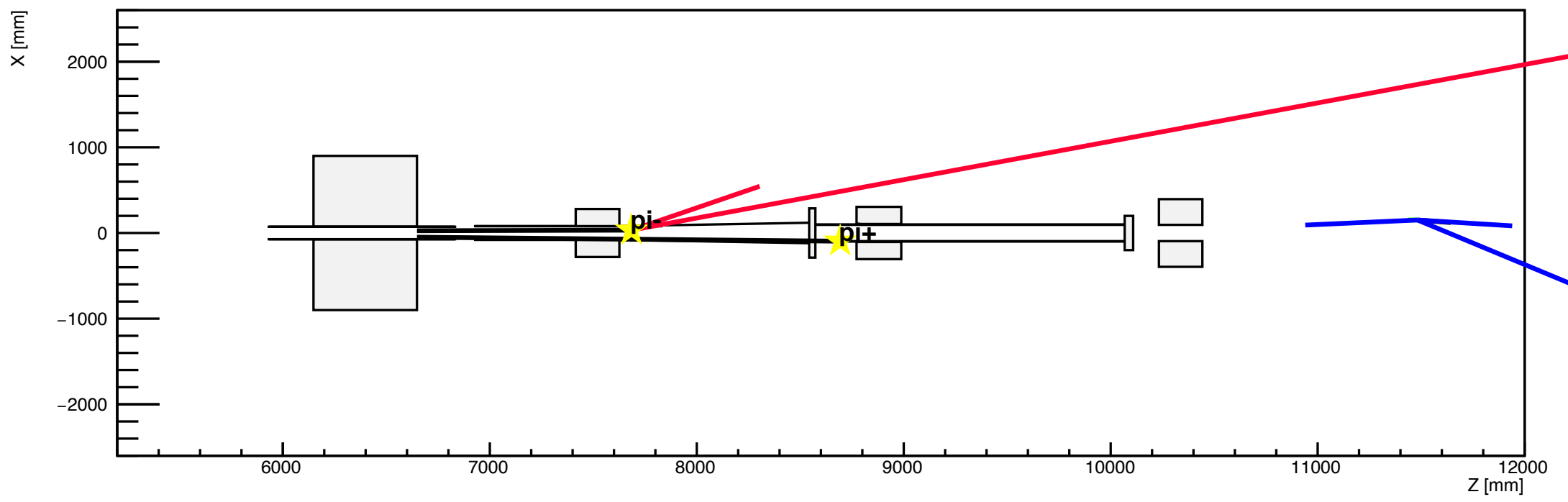

h1

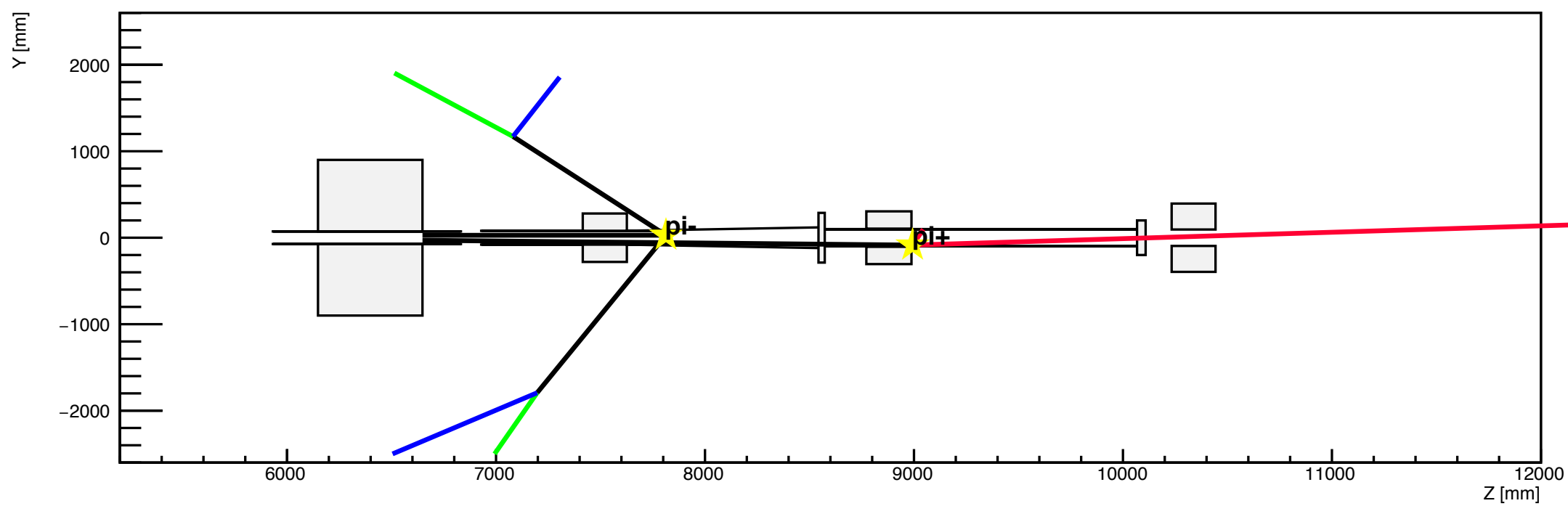

h2

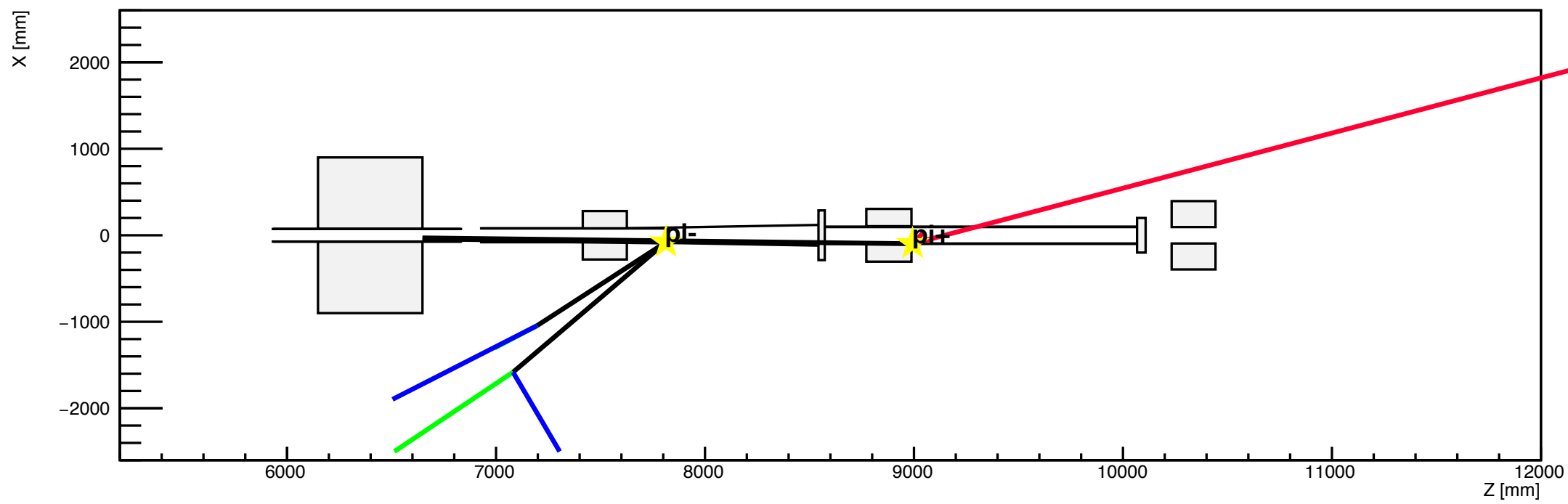

h1

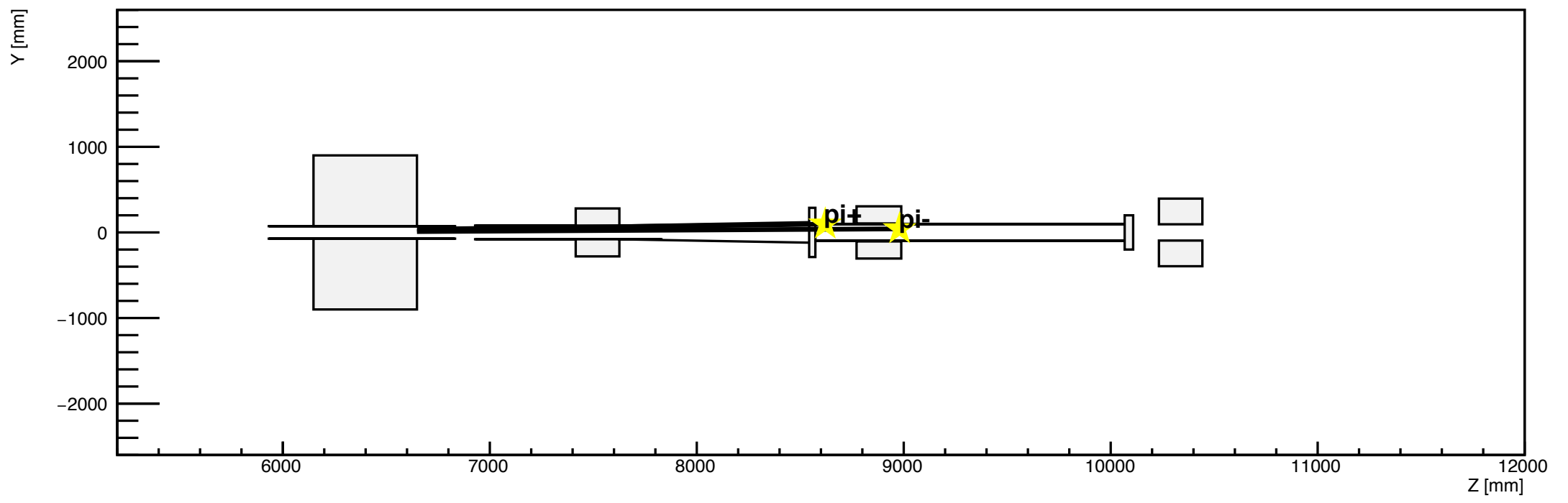

h2

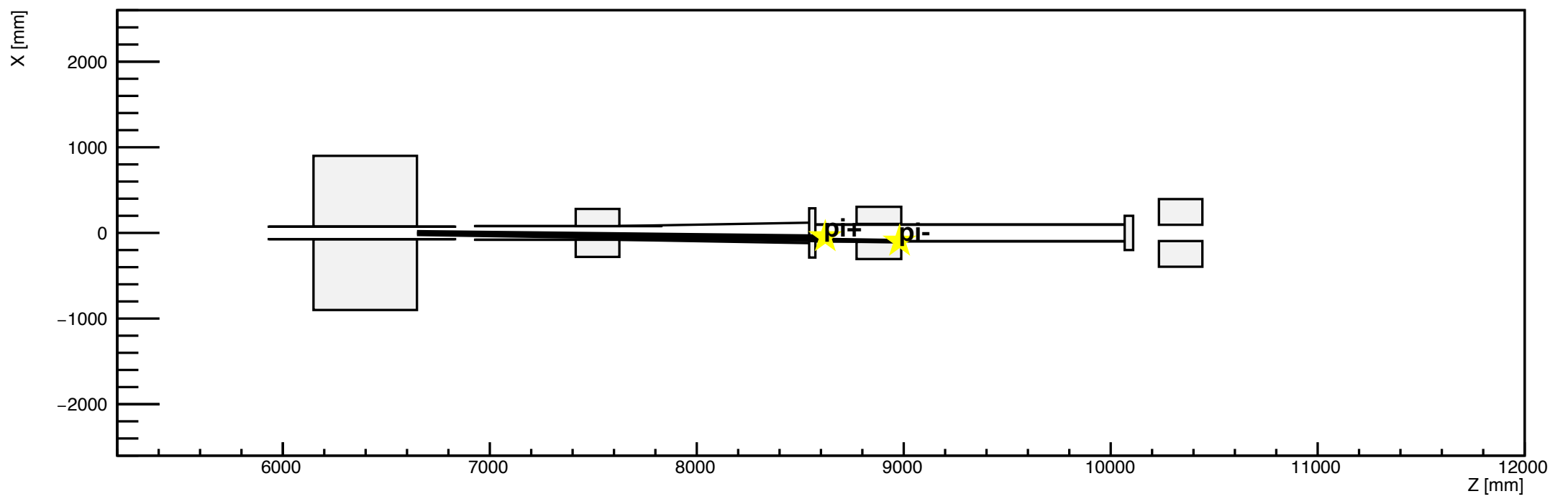

h1

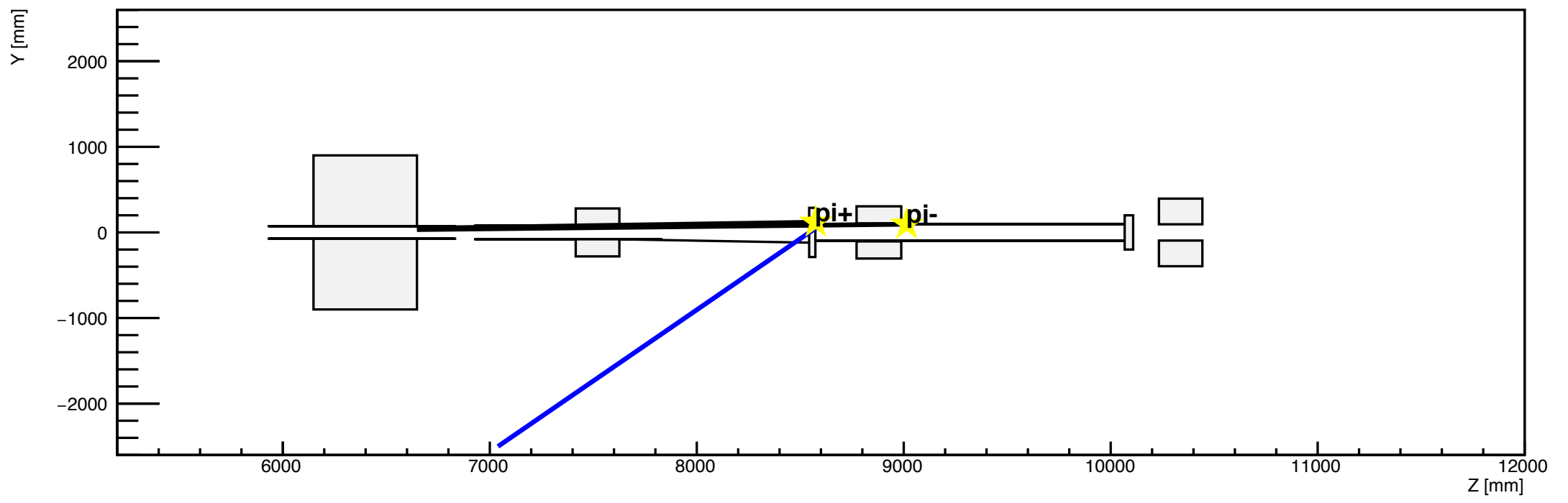

h2

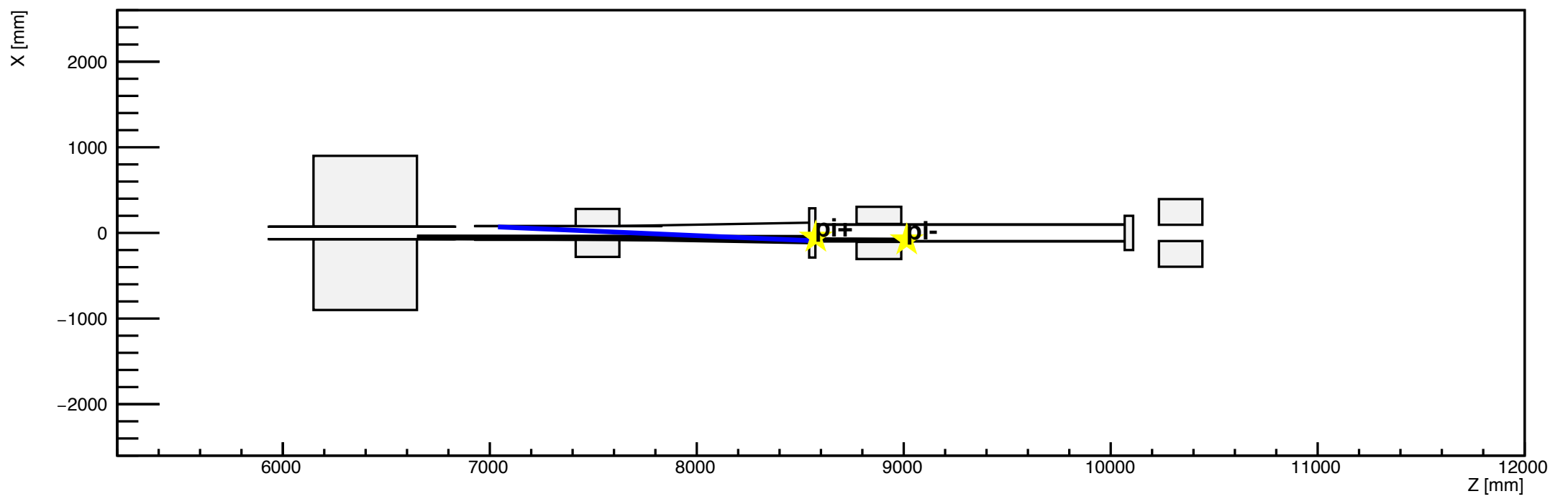

h1

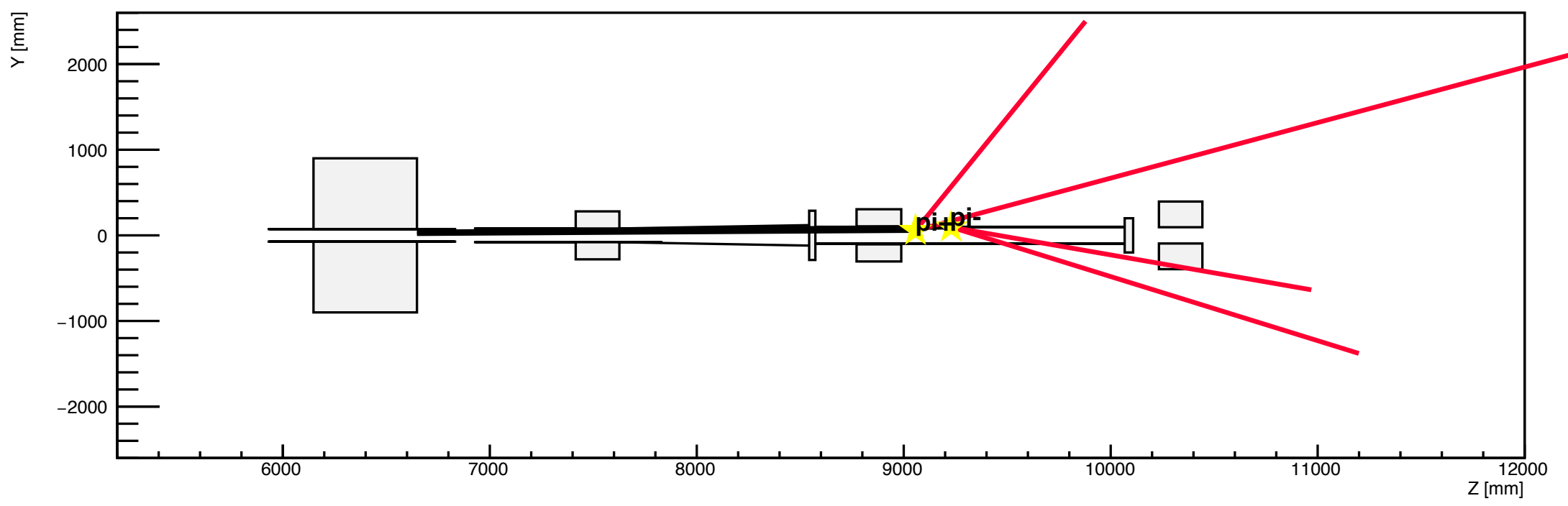

h2

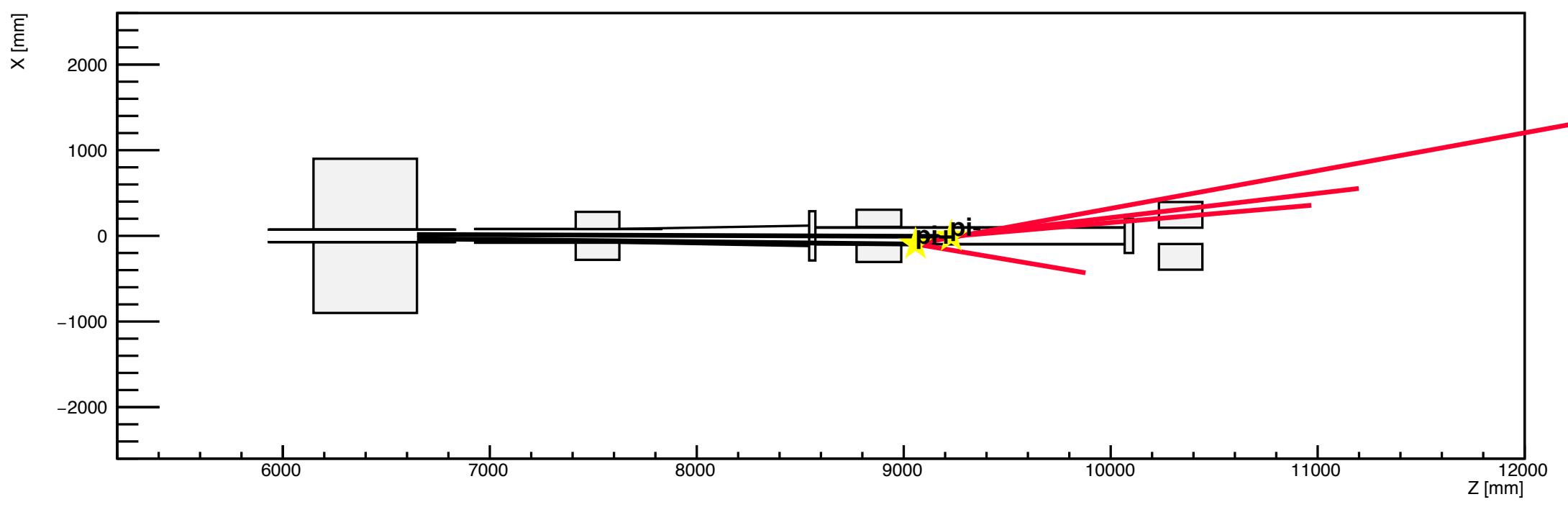

h1

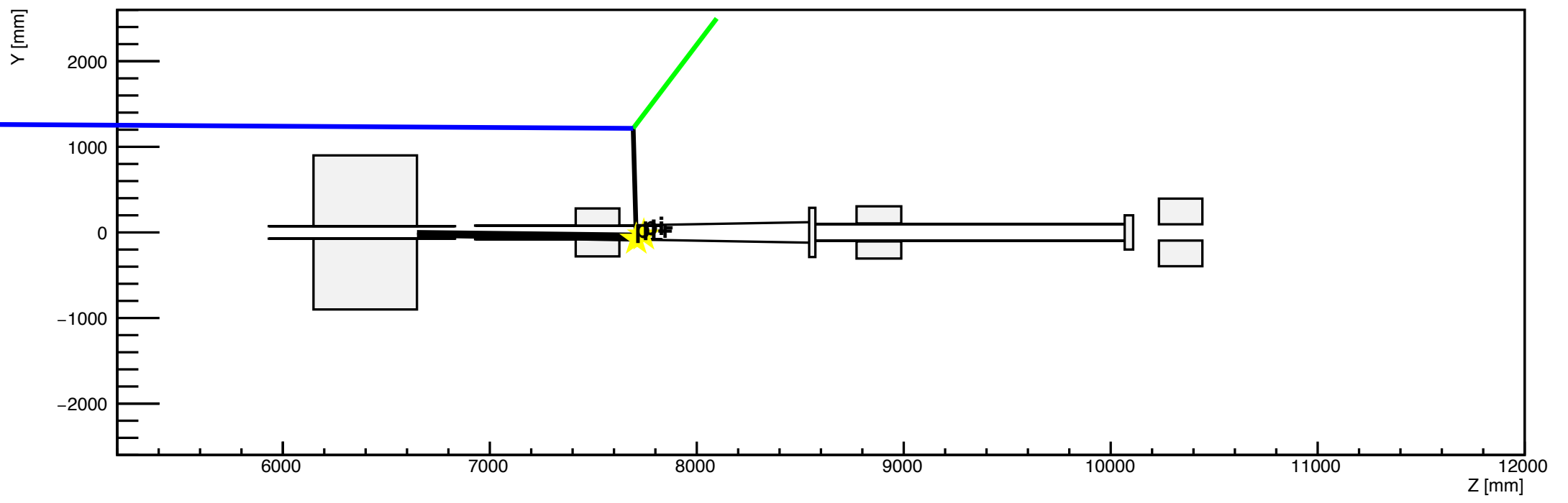

h2

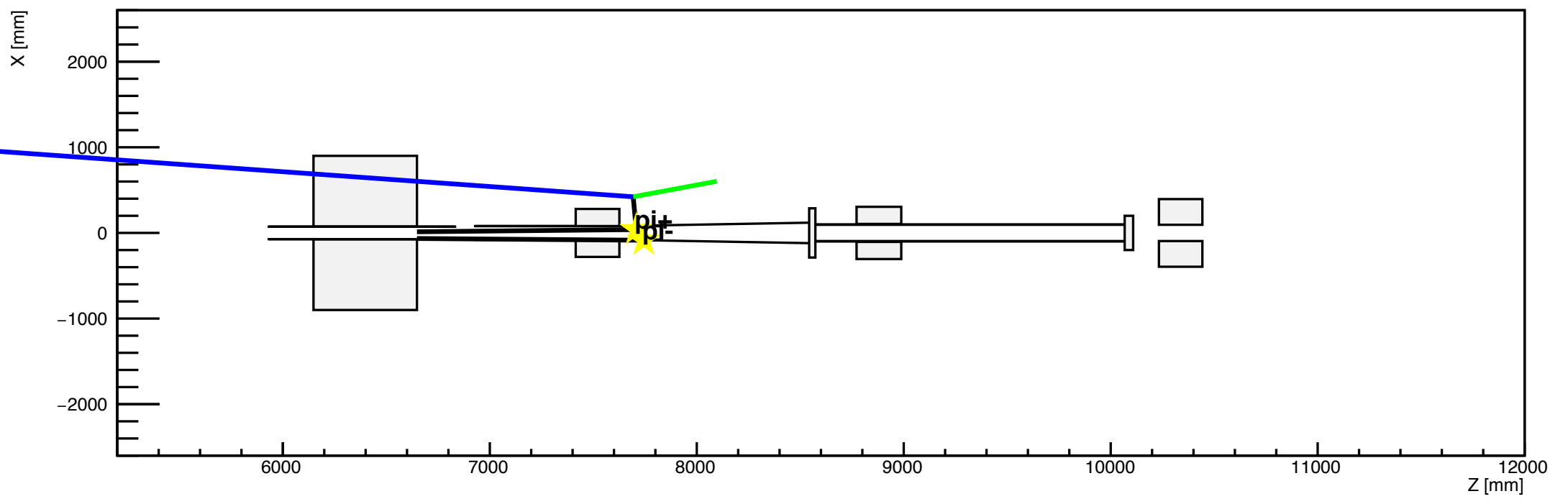

h1

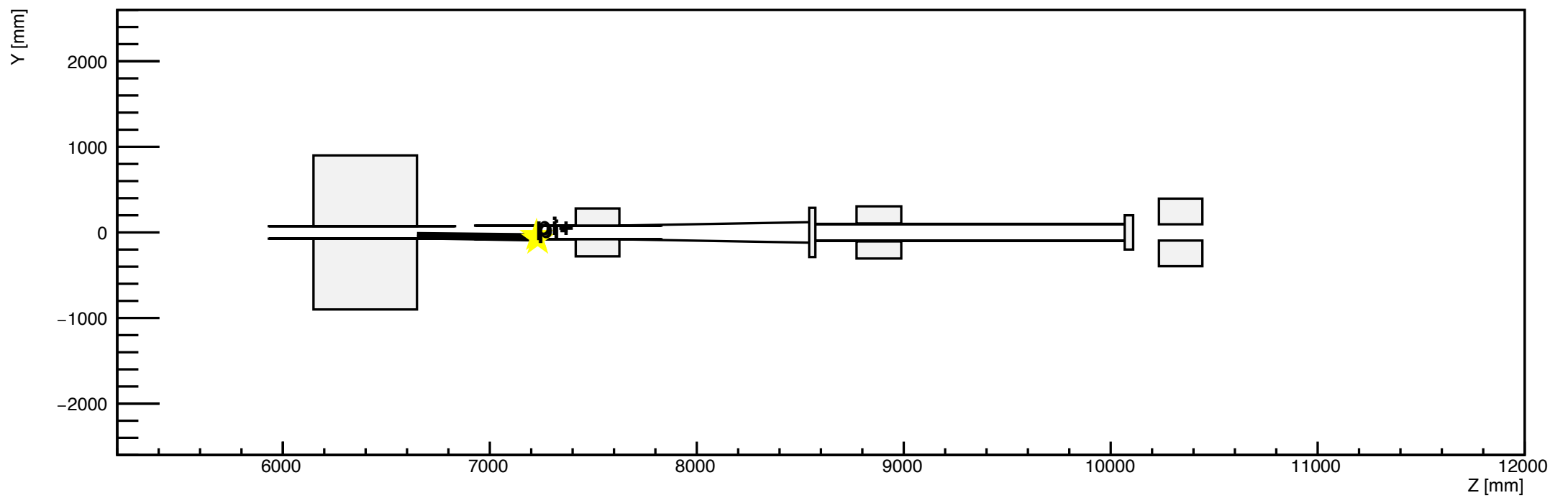

h2

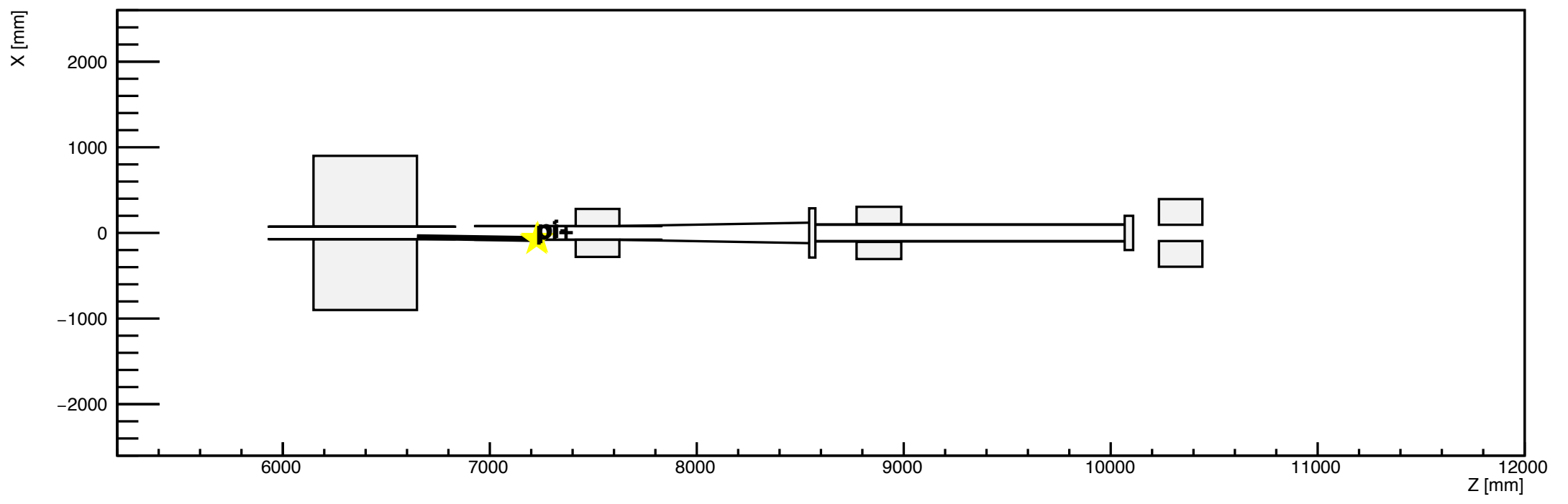

h1

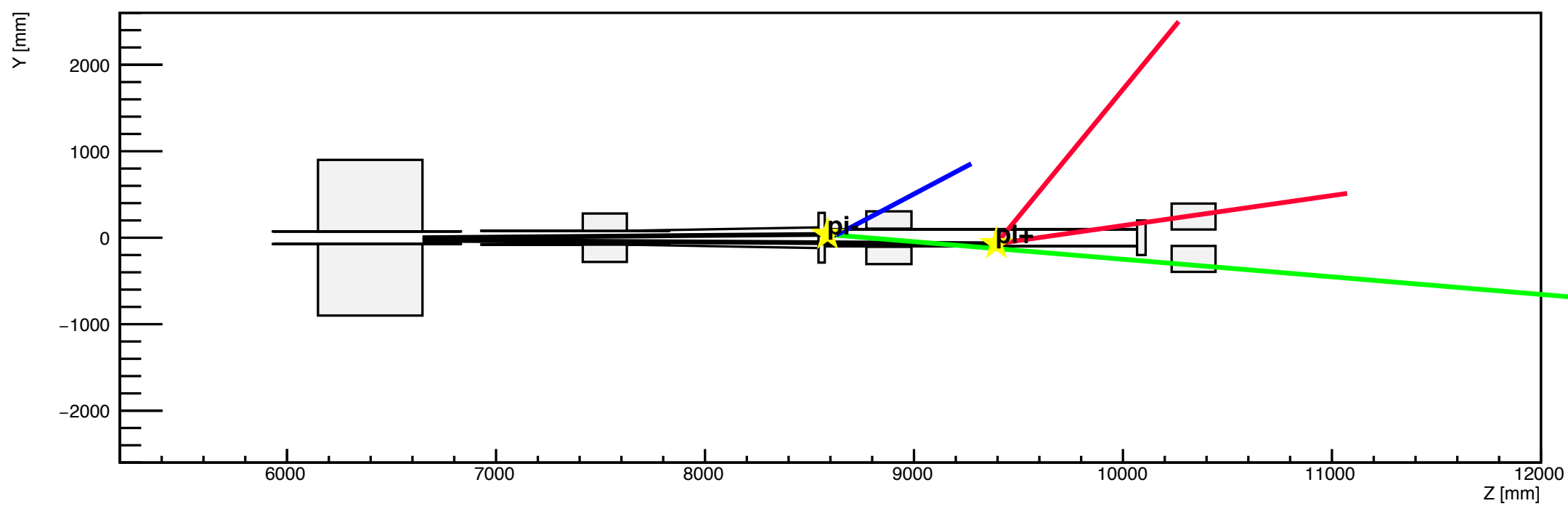

h2

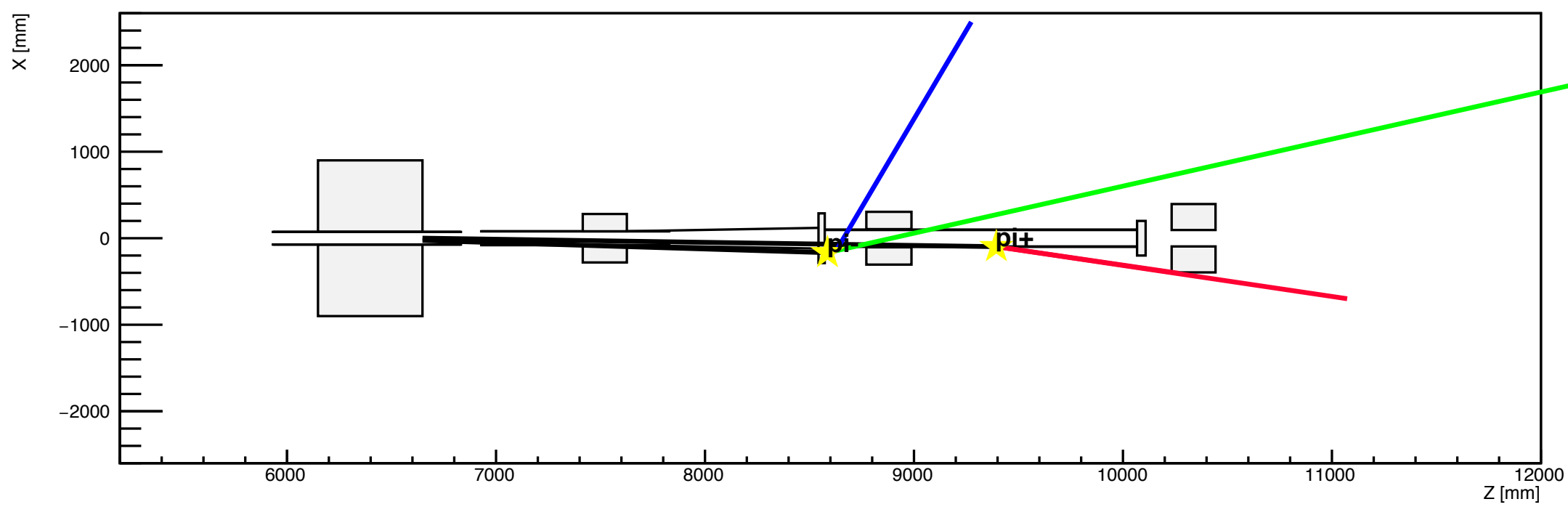

h1

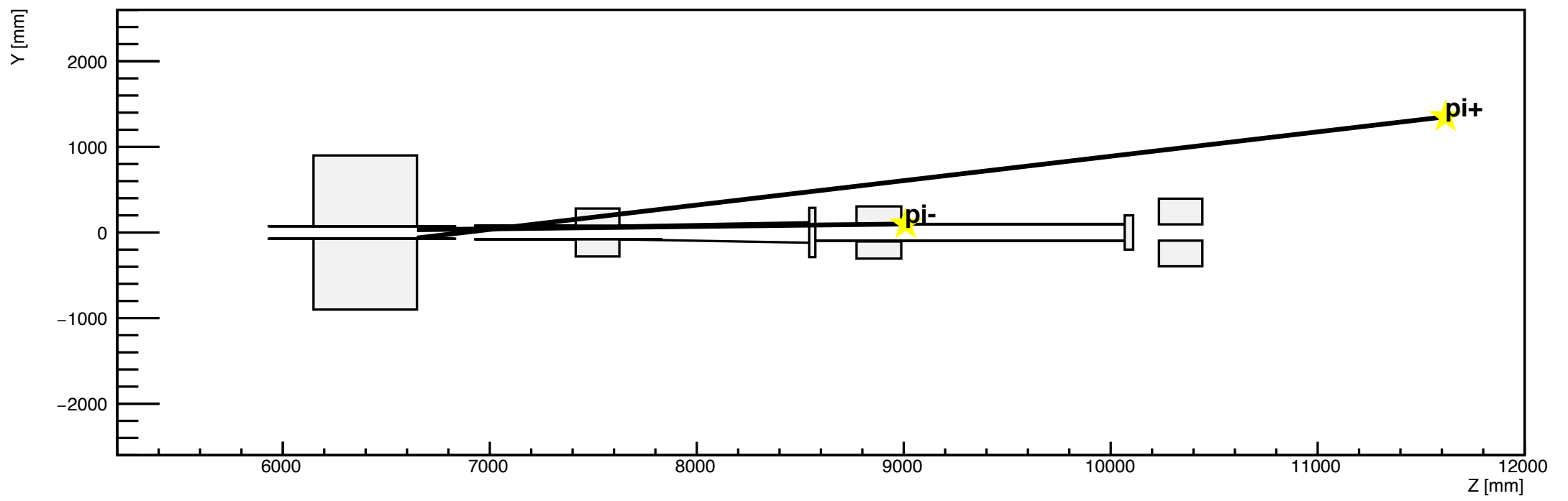

h2

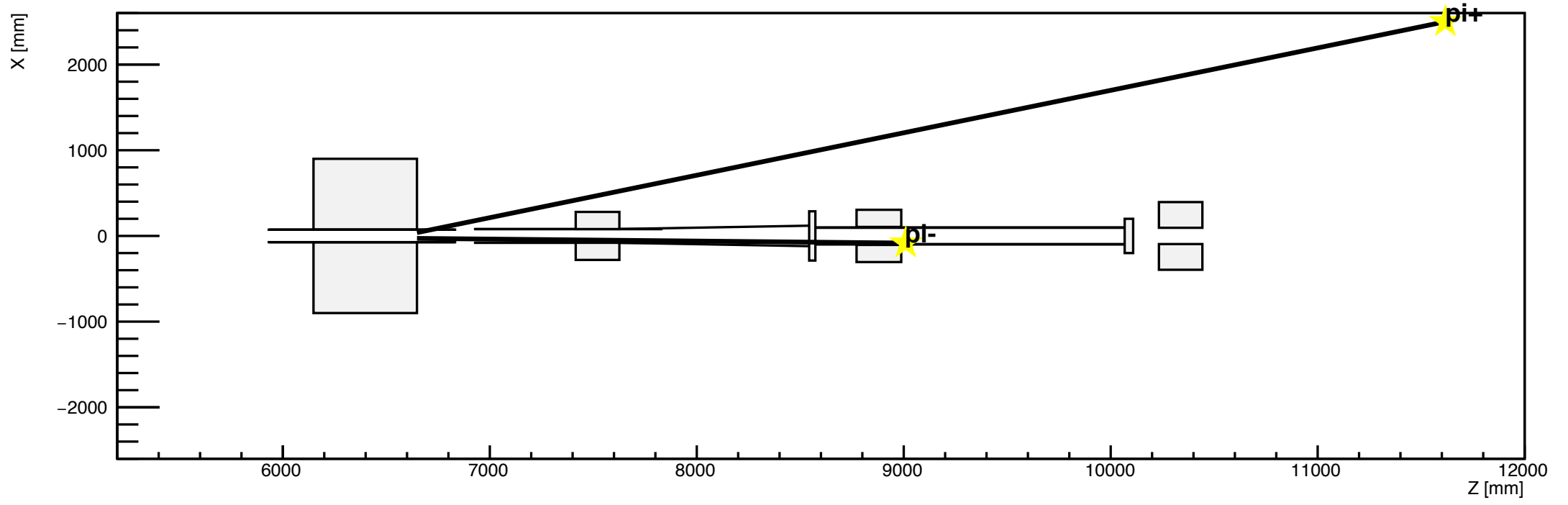

h1

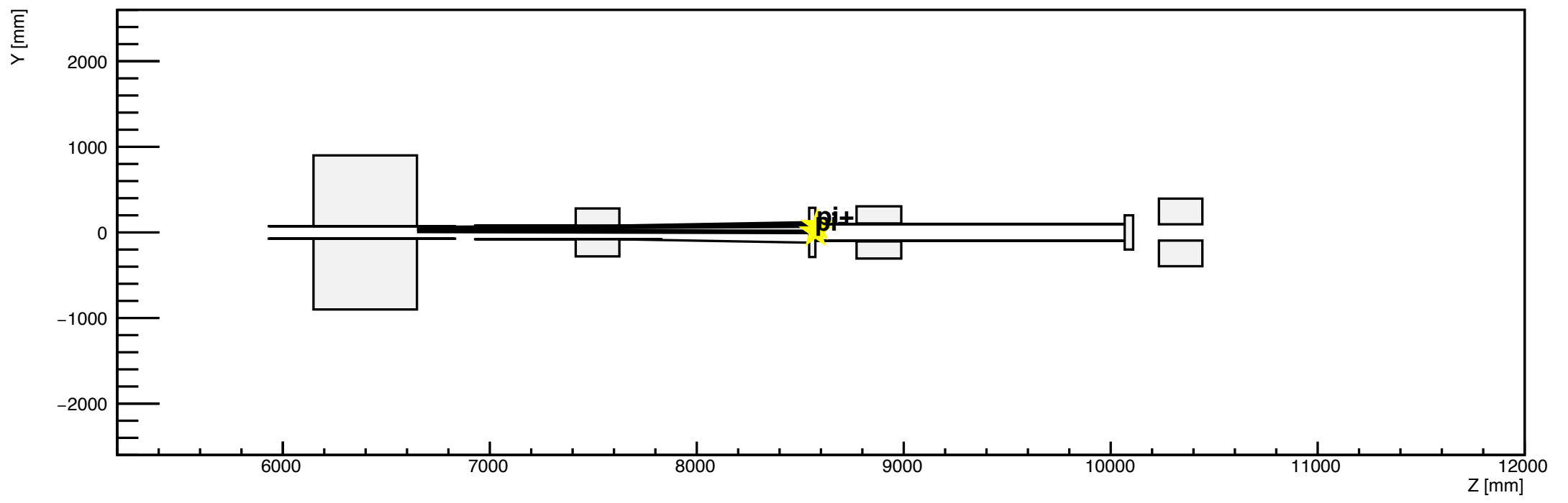

h2

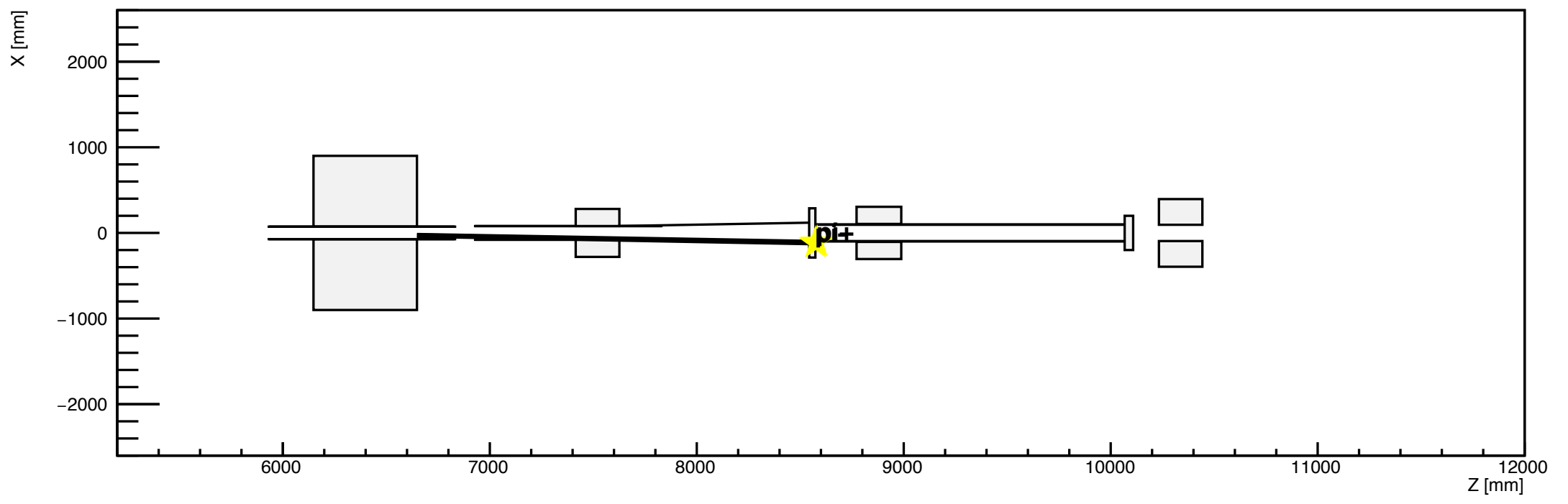

h1

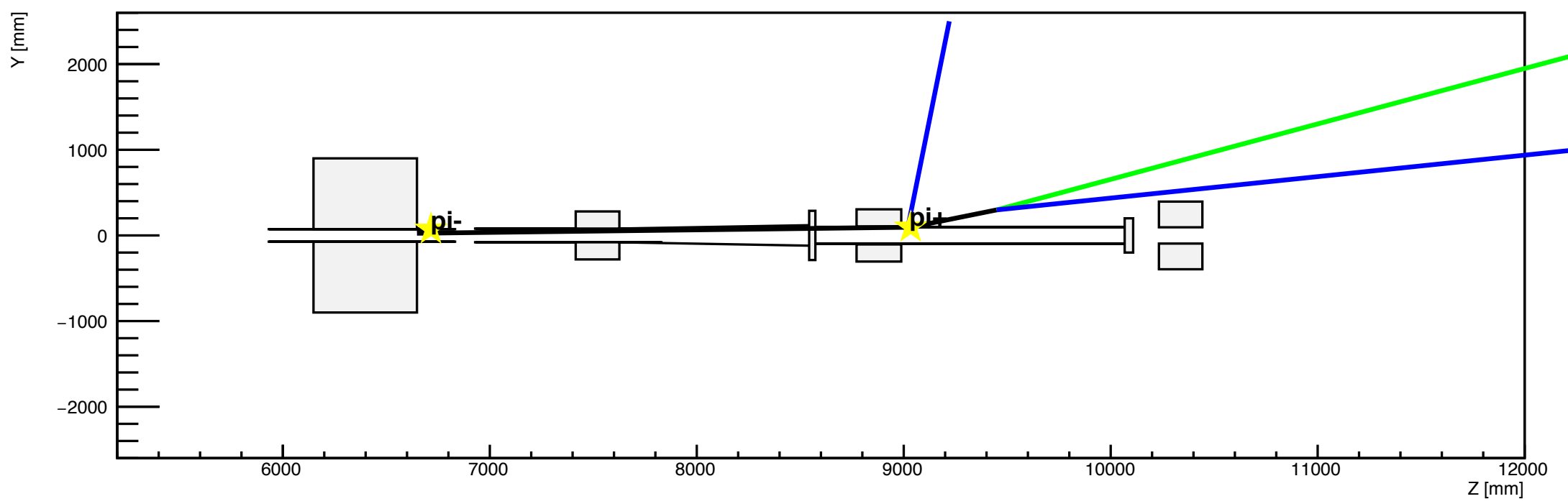

h2

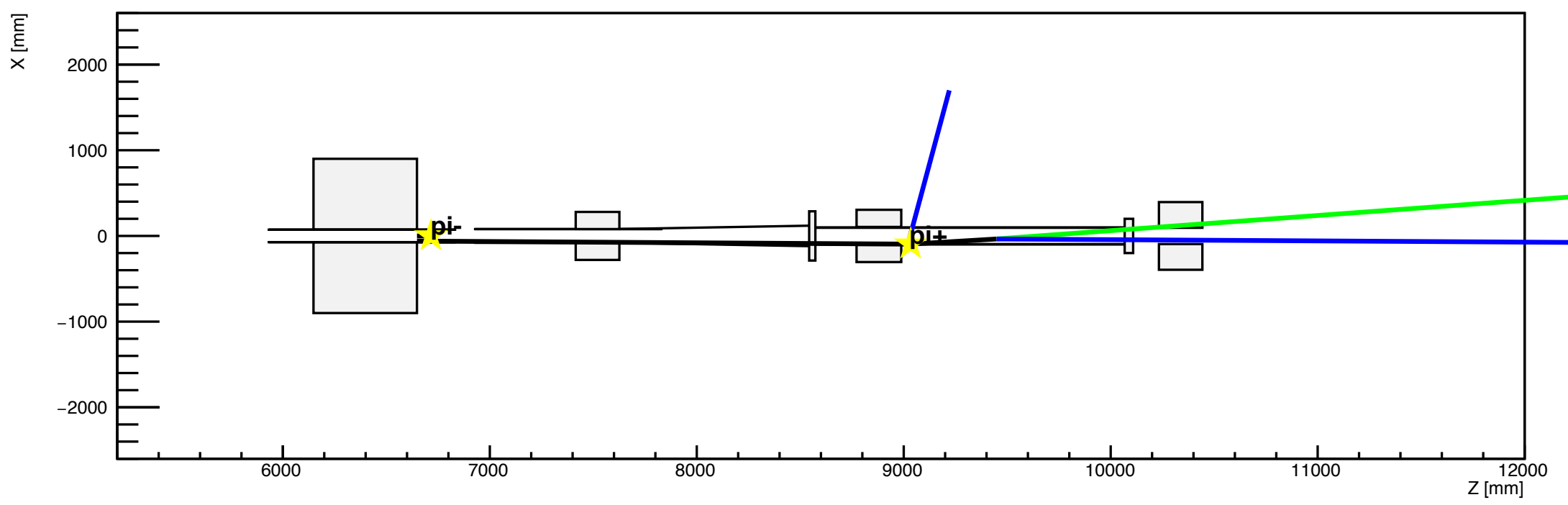

h1

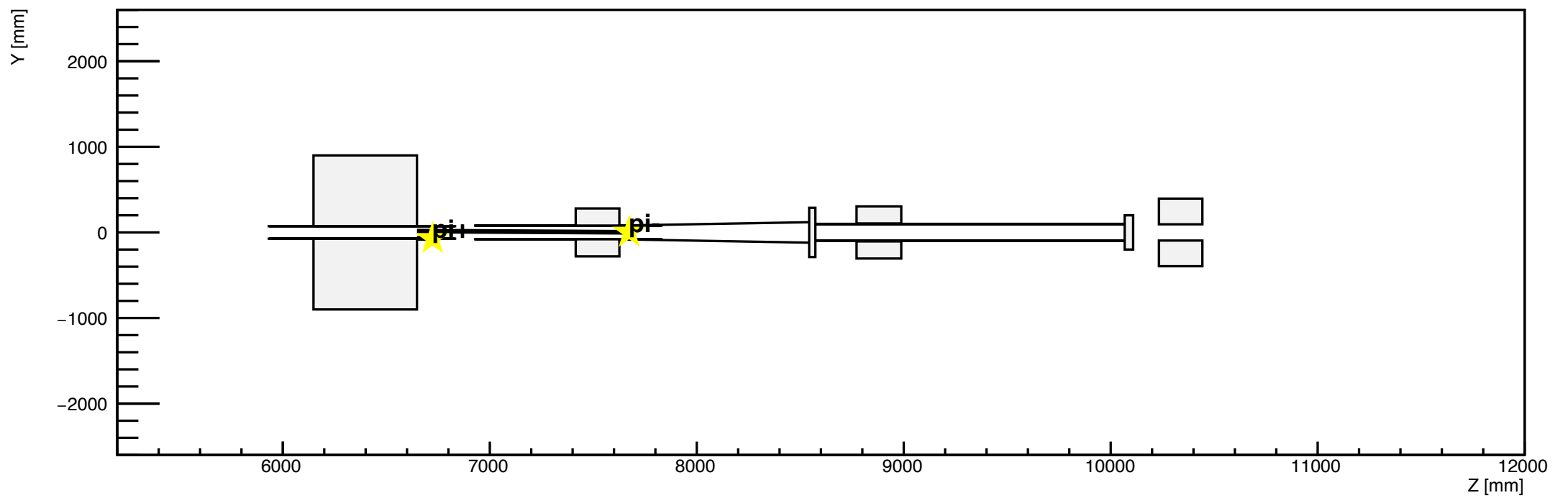

h2

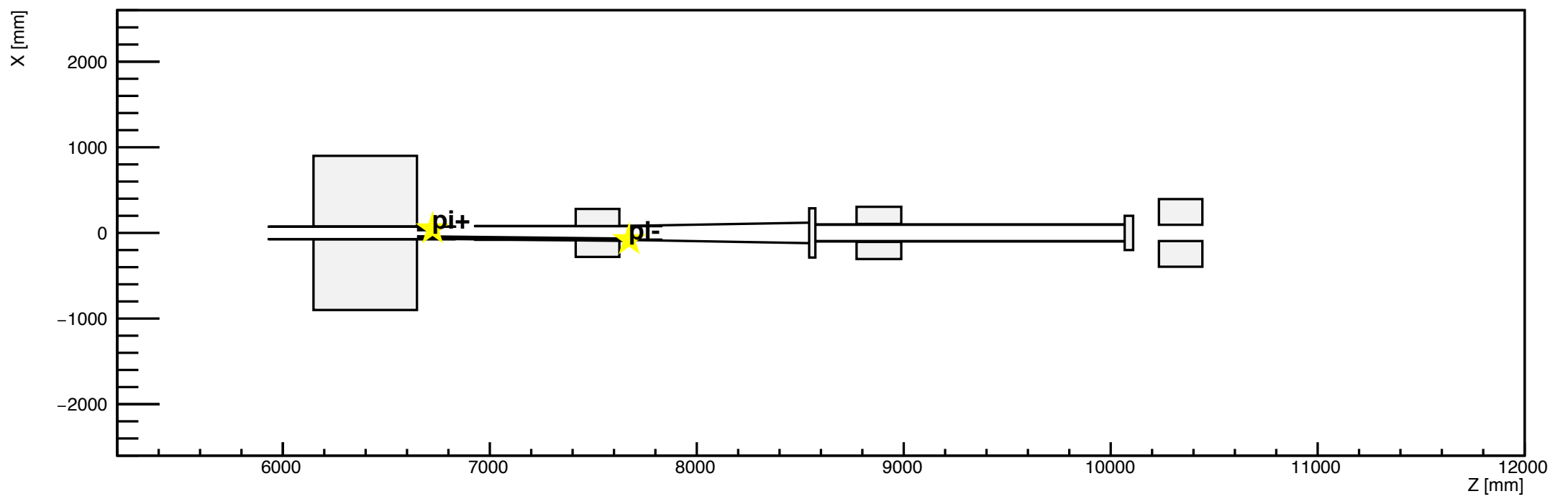

h1

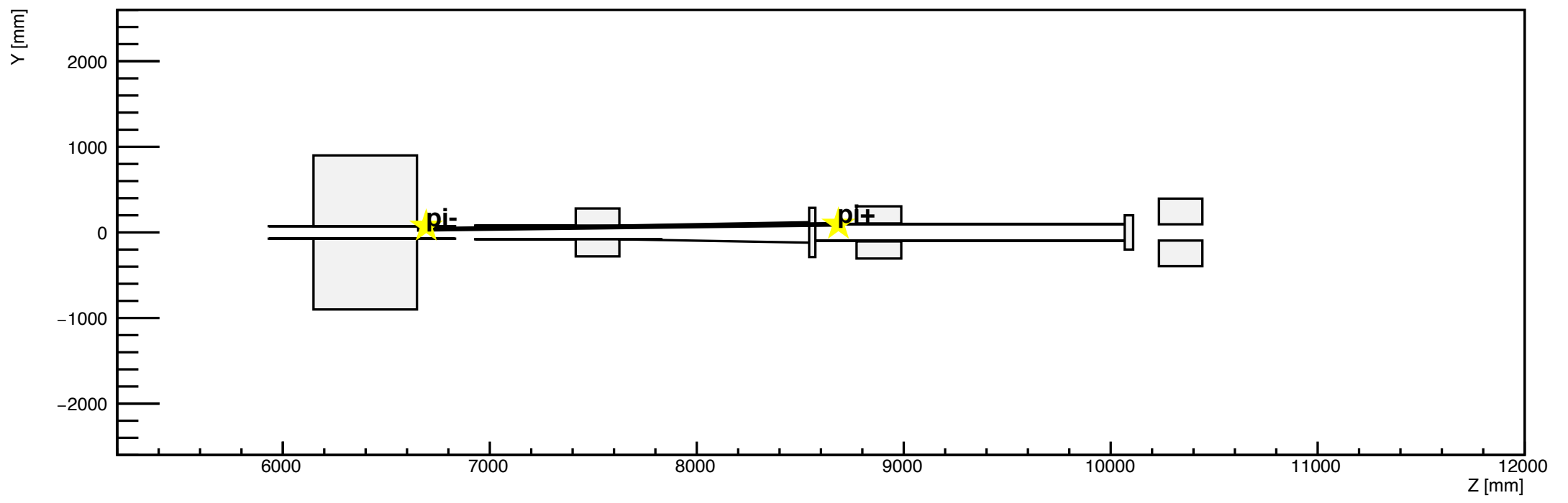

h2

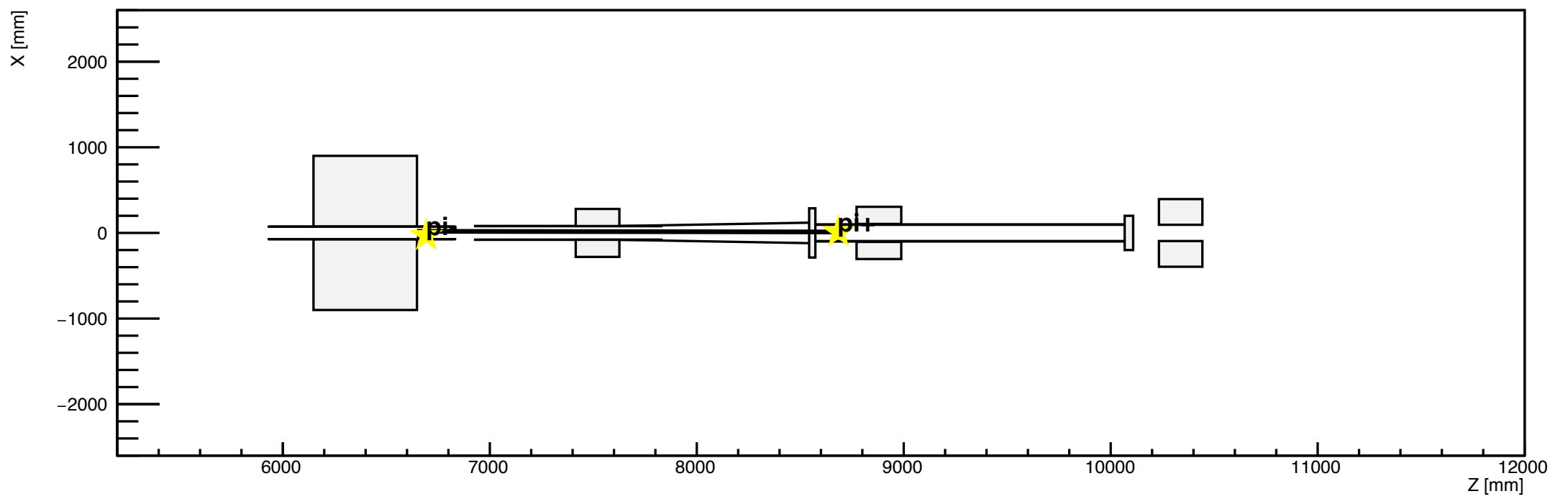

h1

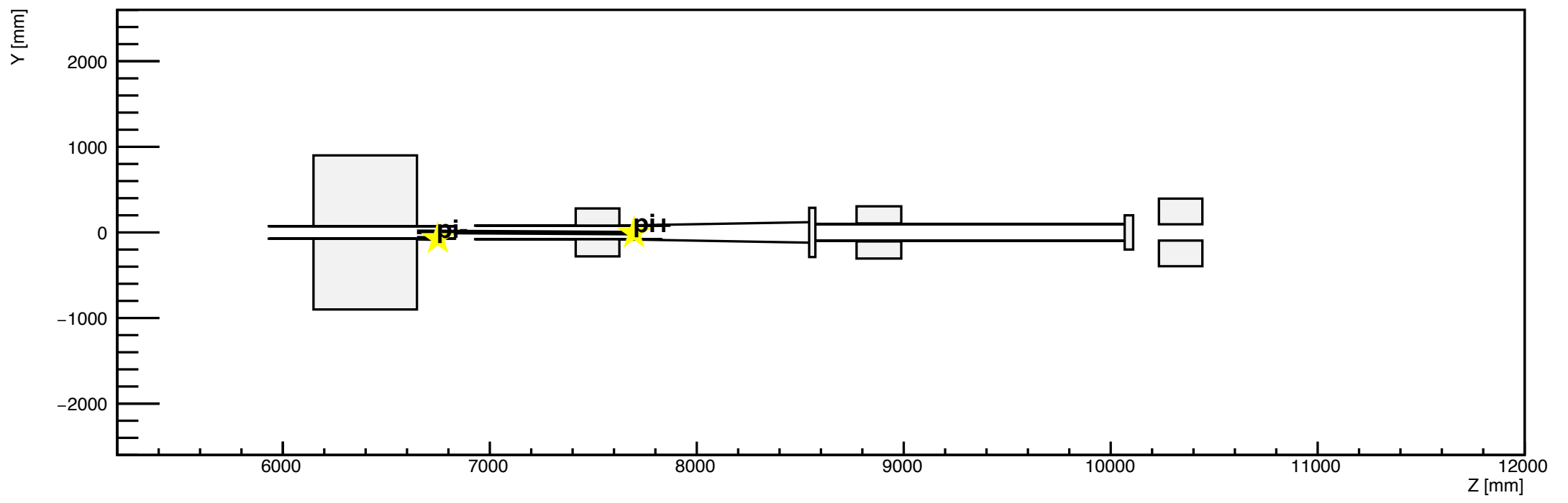

h2

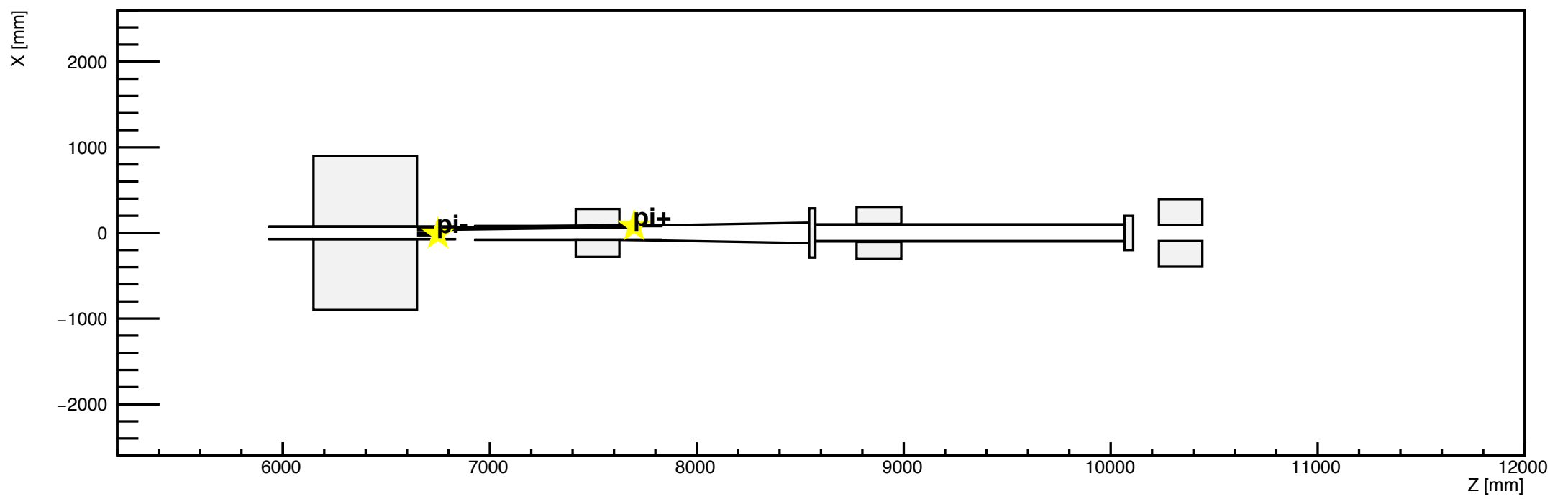

h1

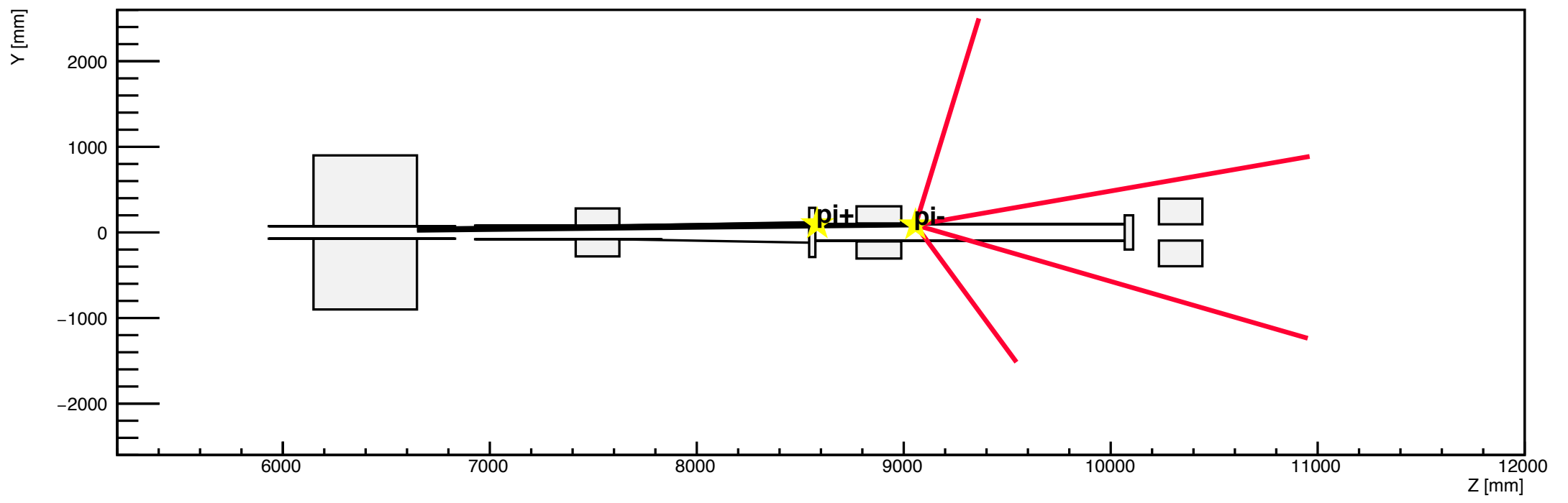

h2

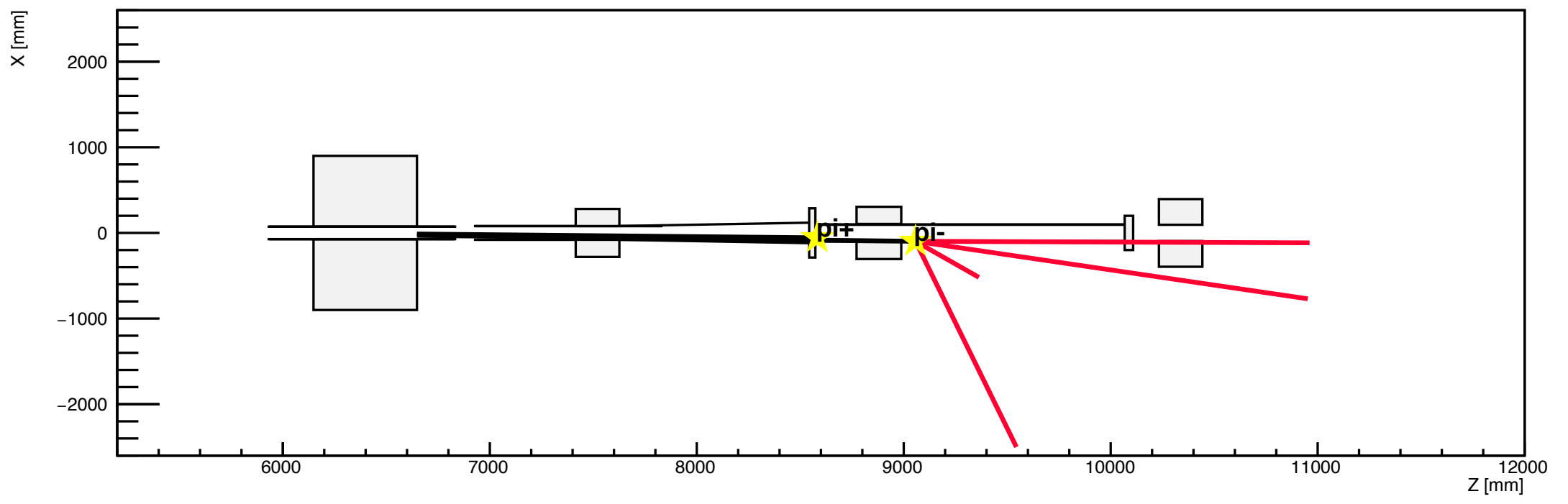

h1

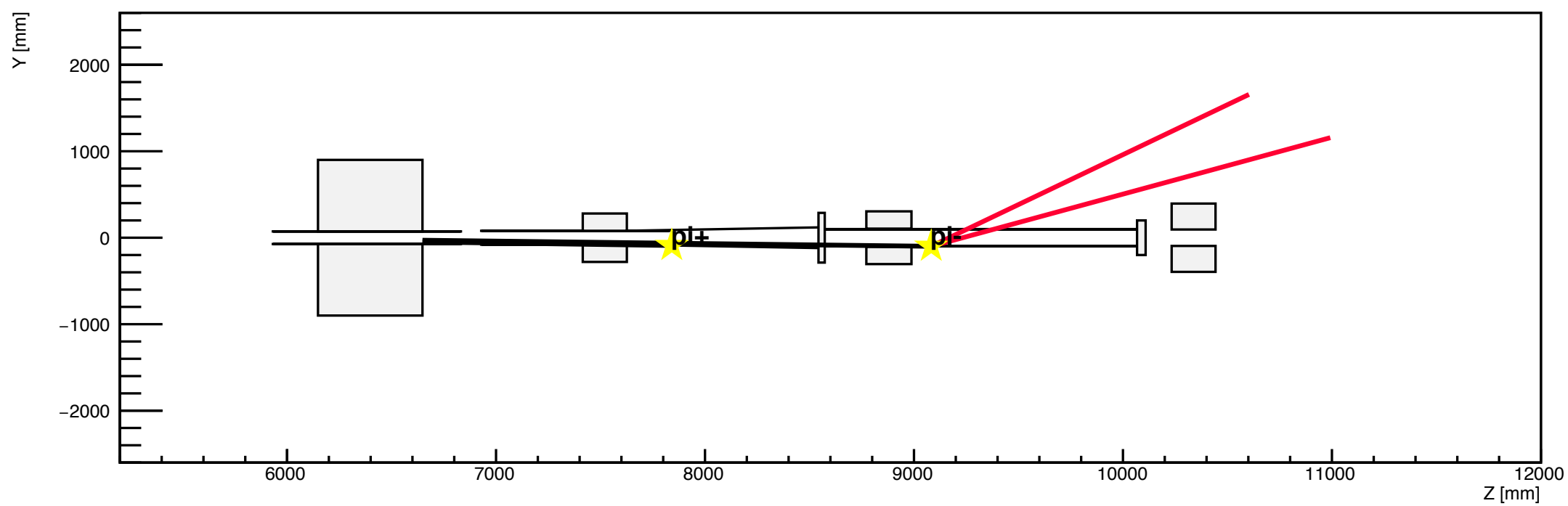

h2

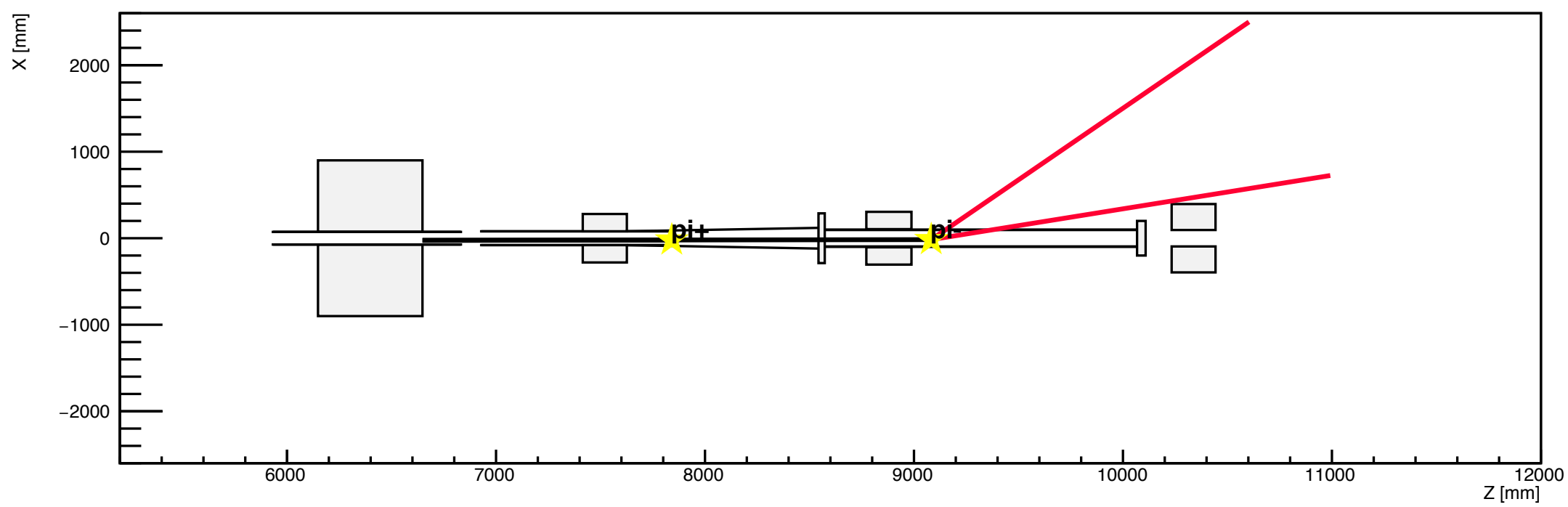

h1

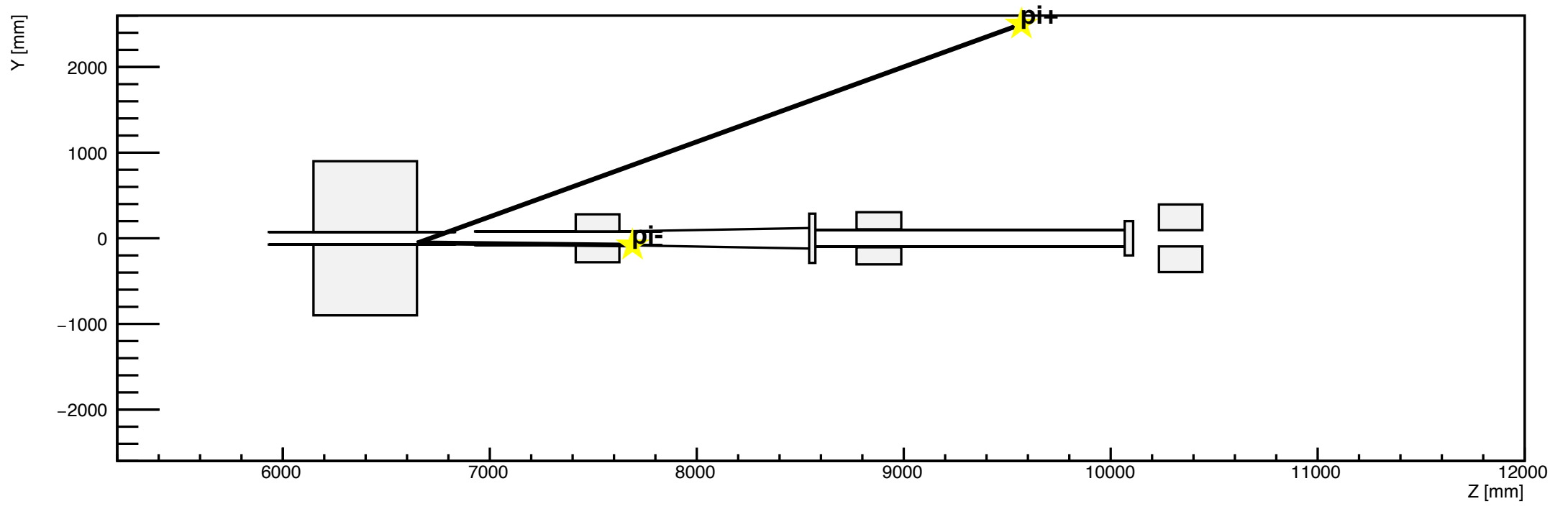

h2

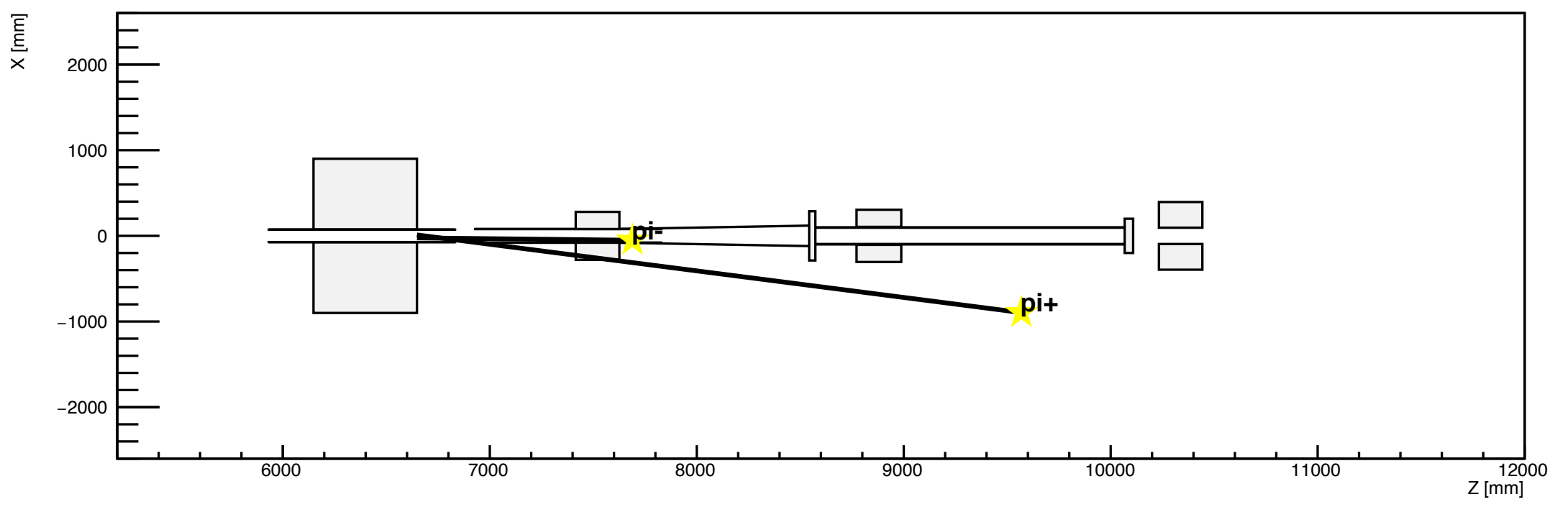

h1

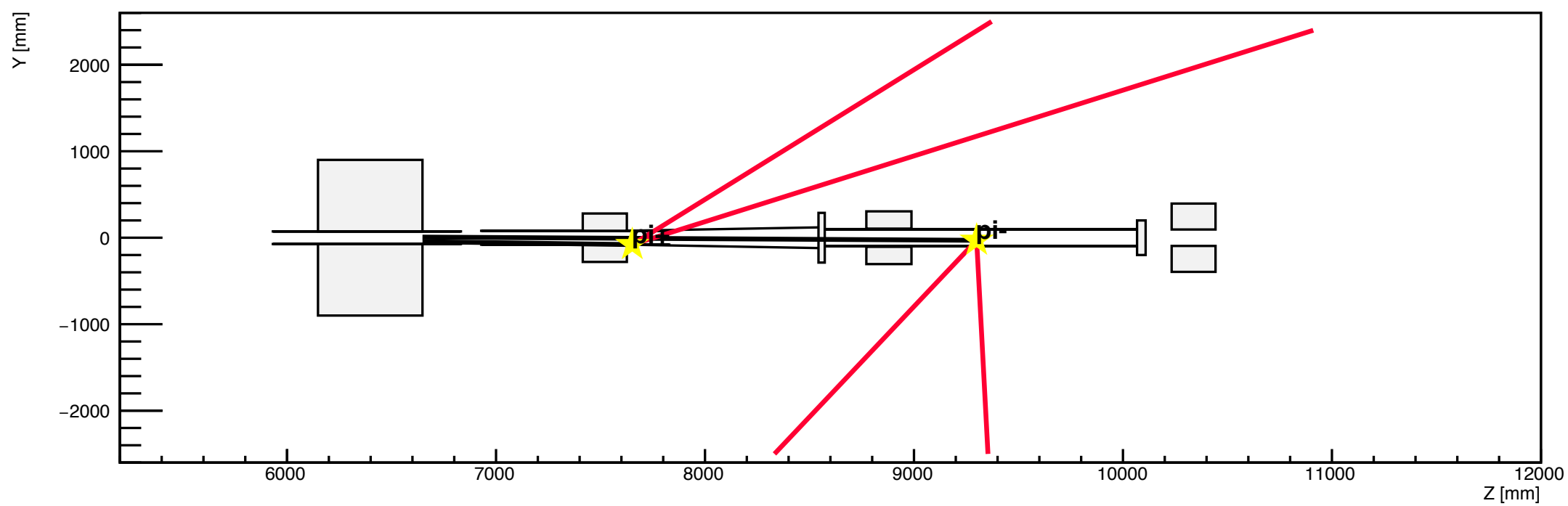

h2

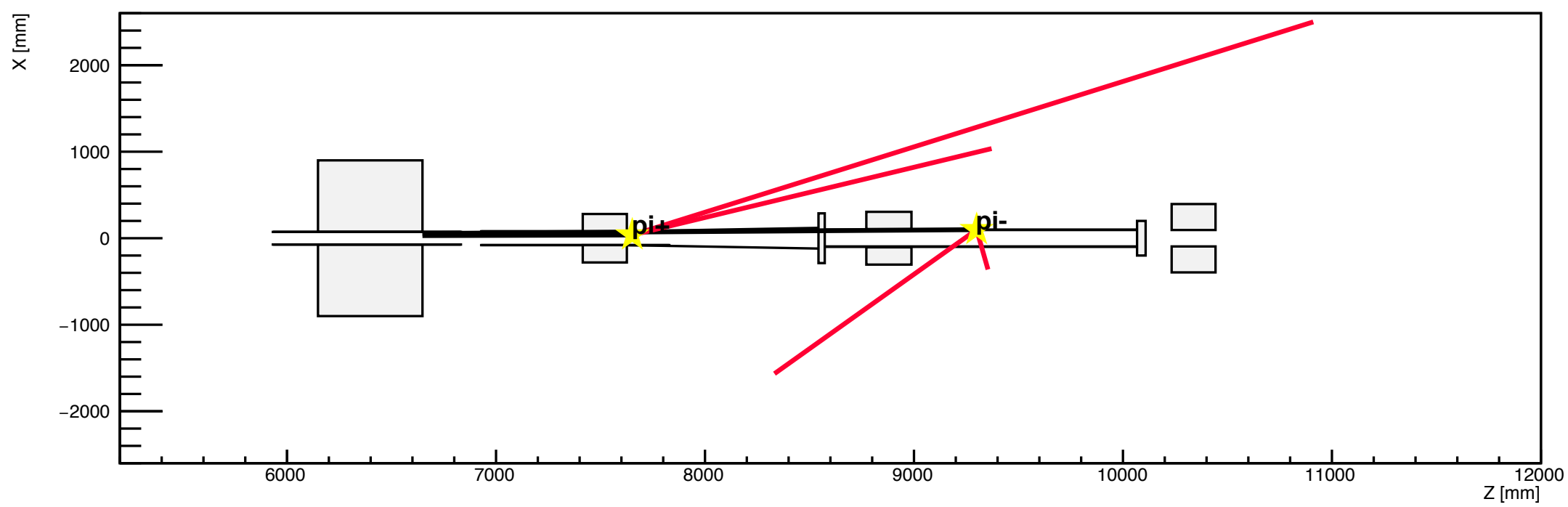

h1

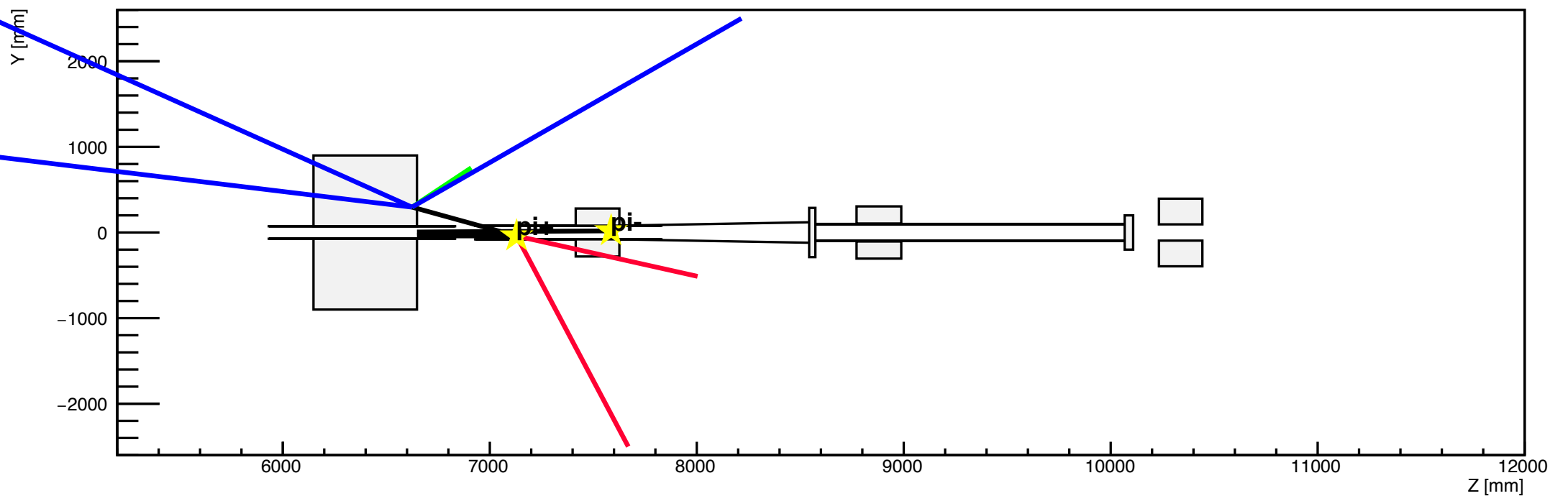

h2

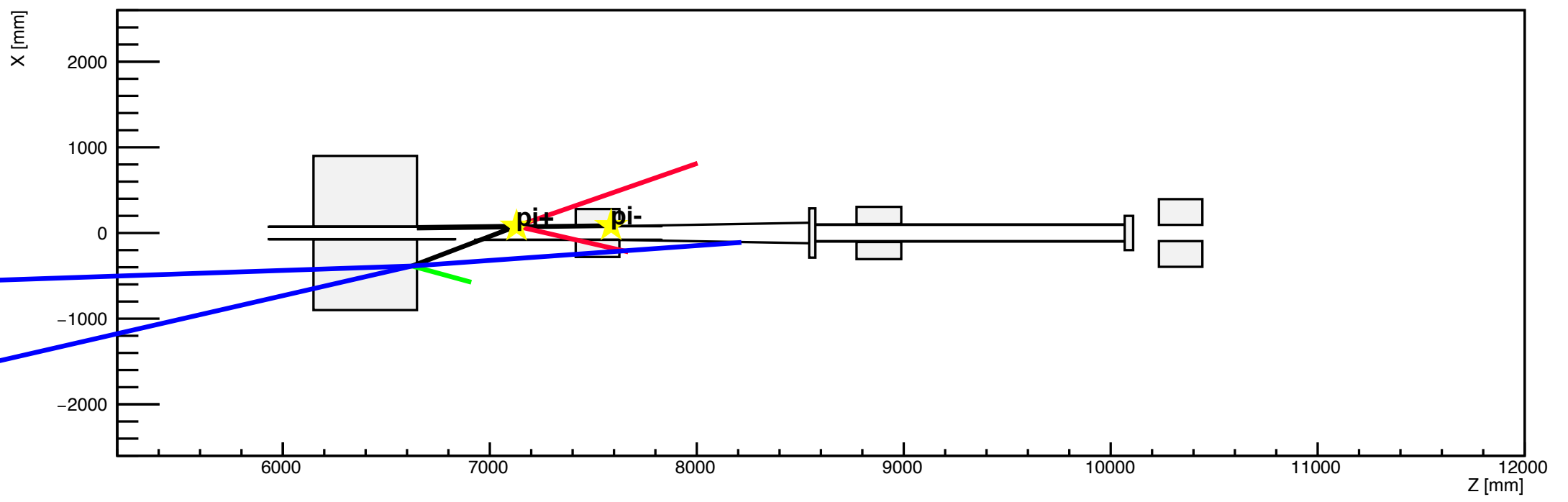

h1

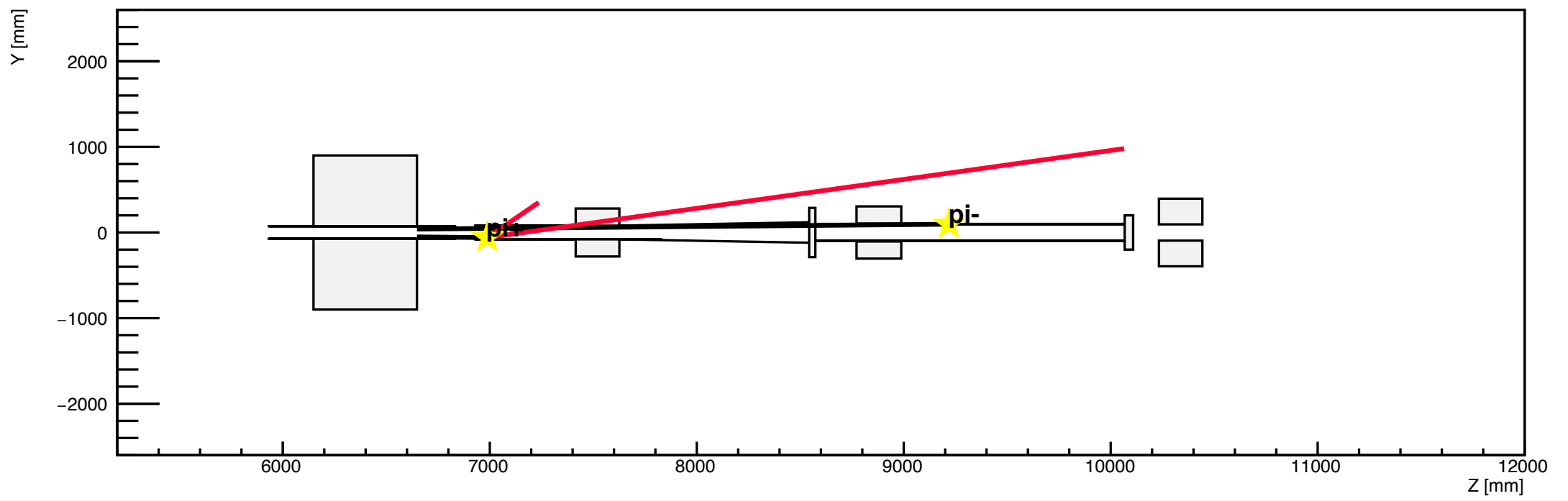

h2

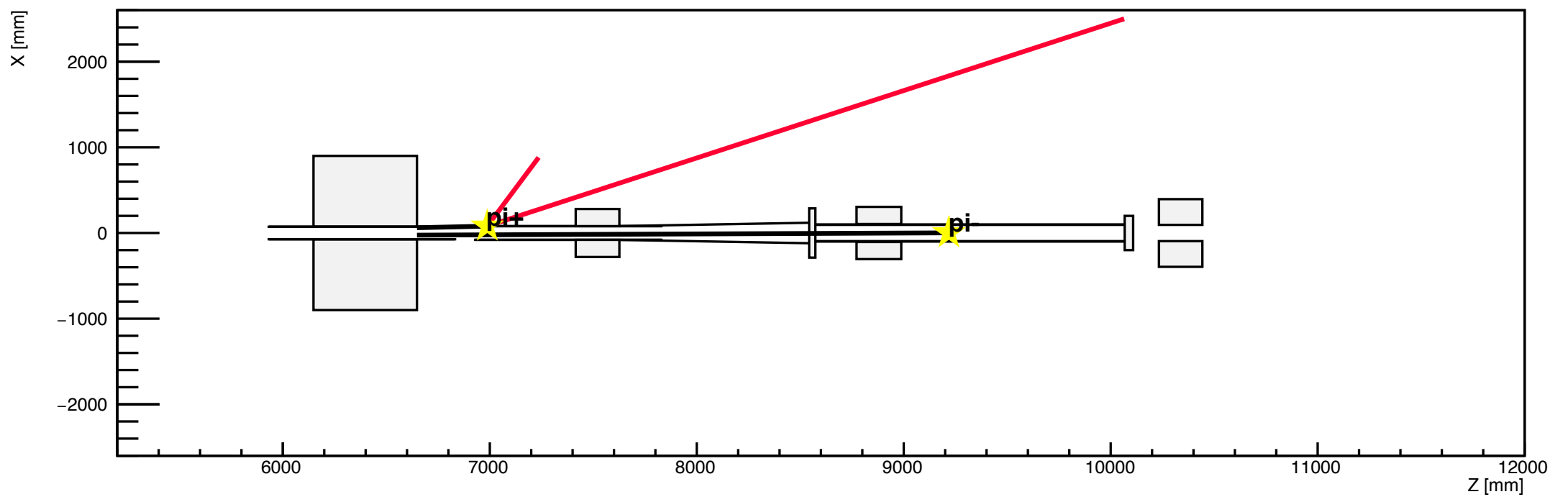

h1

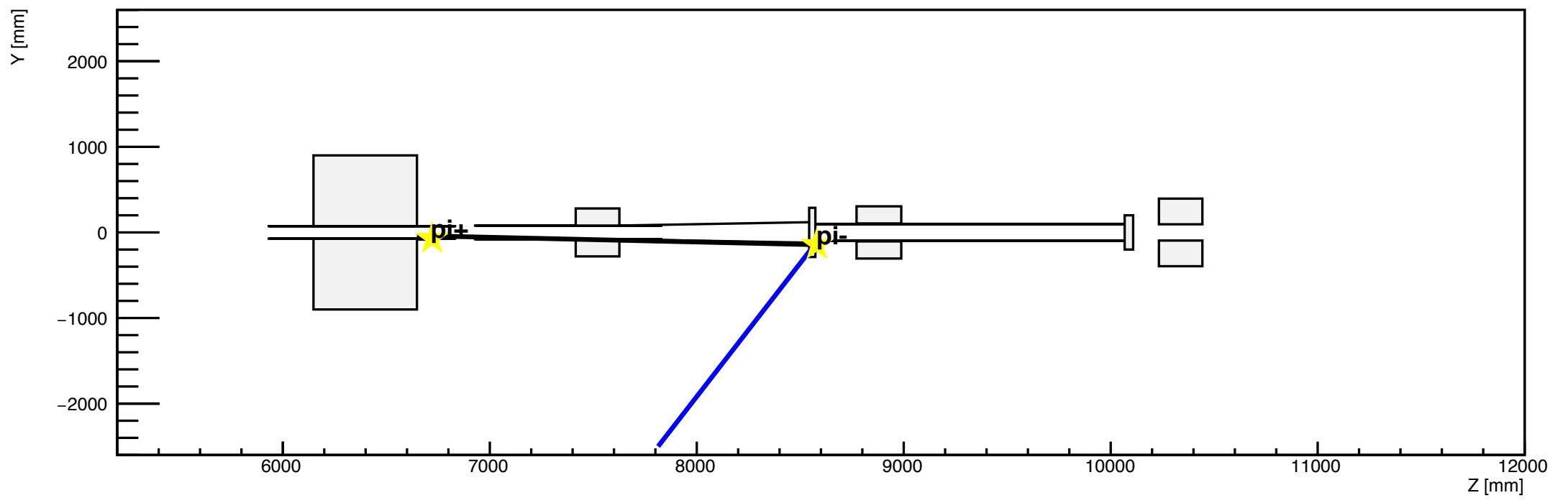

h2

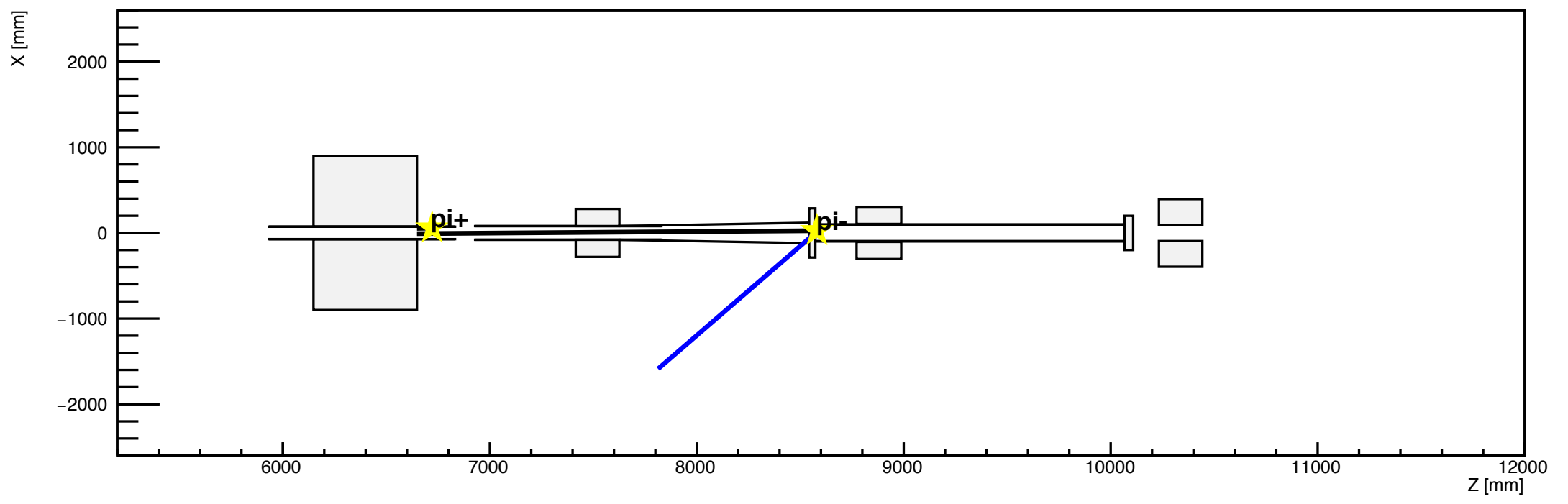

h1

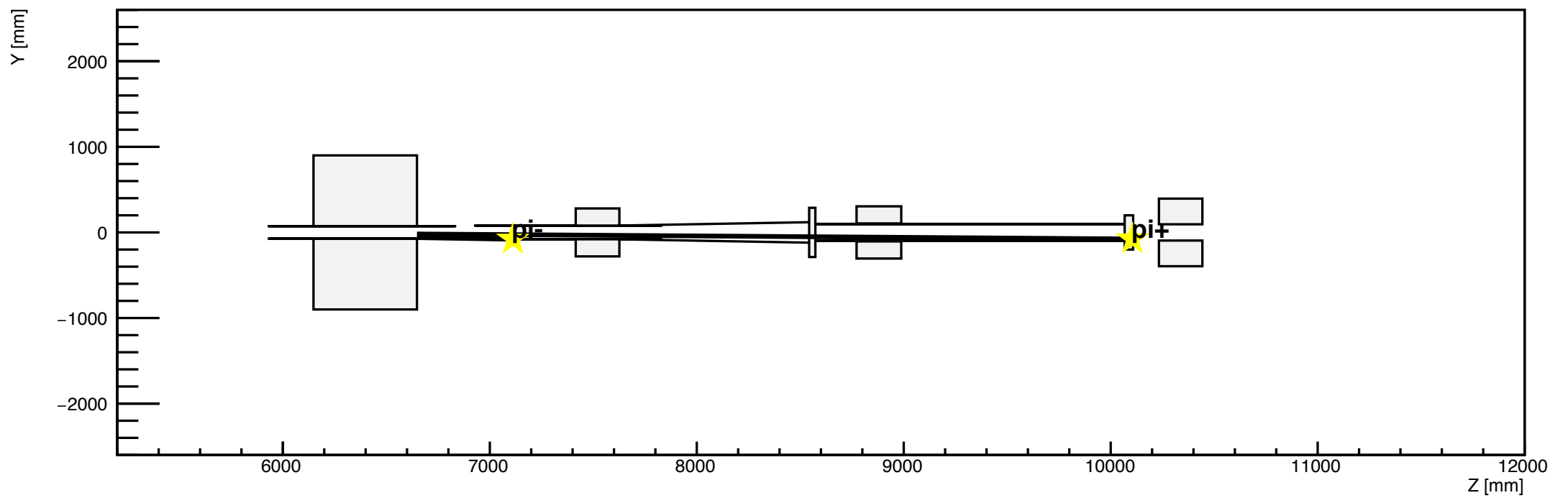

h2

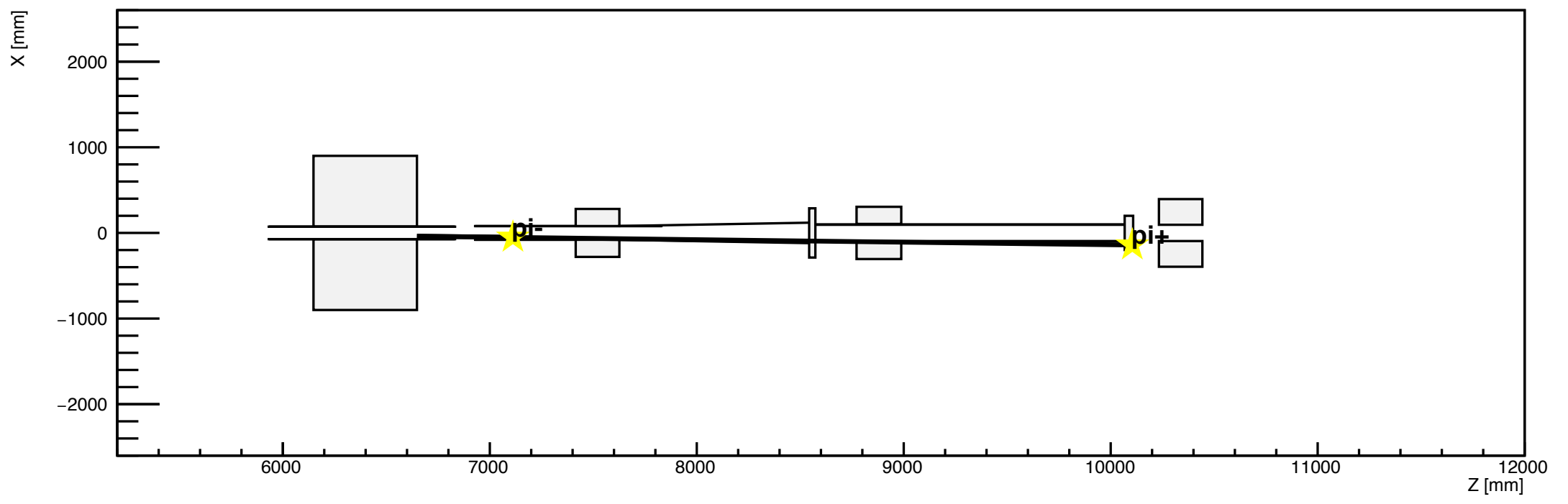

h1

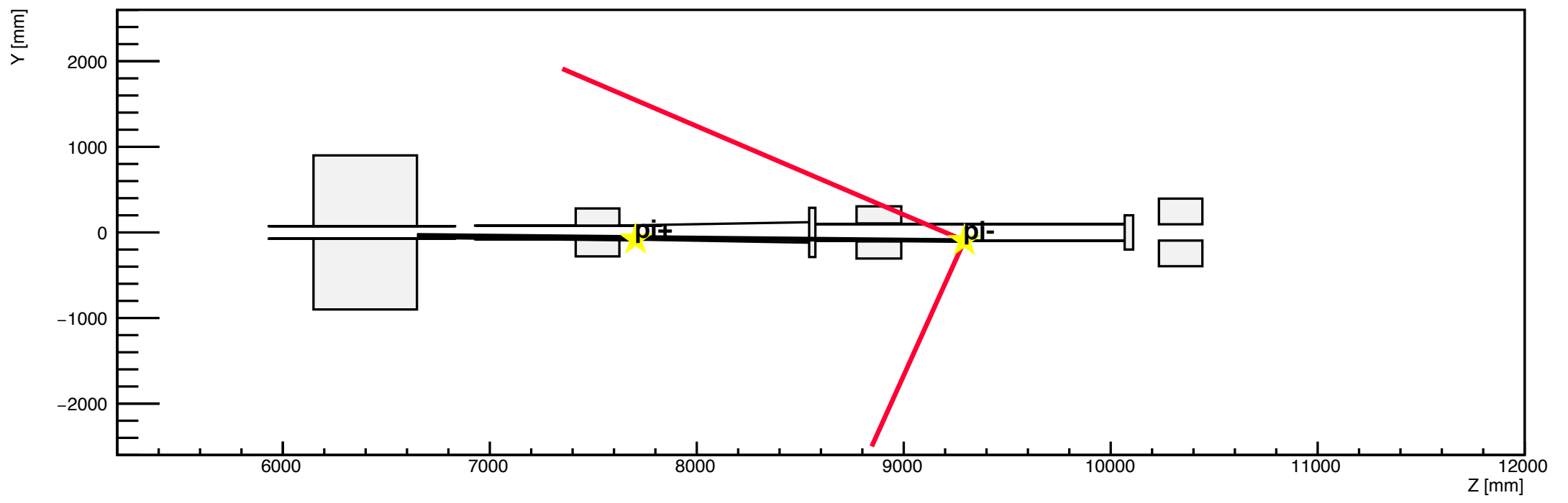

h2

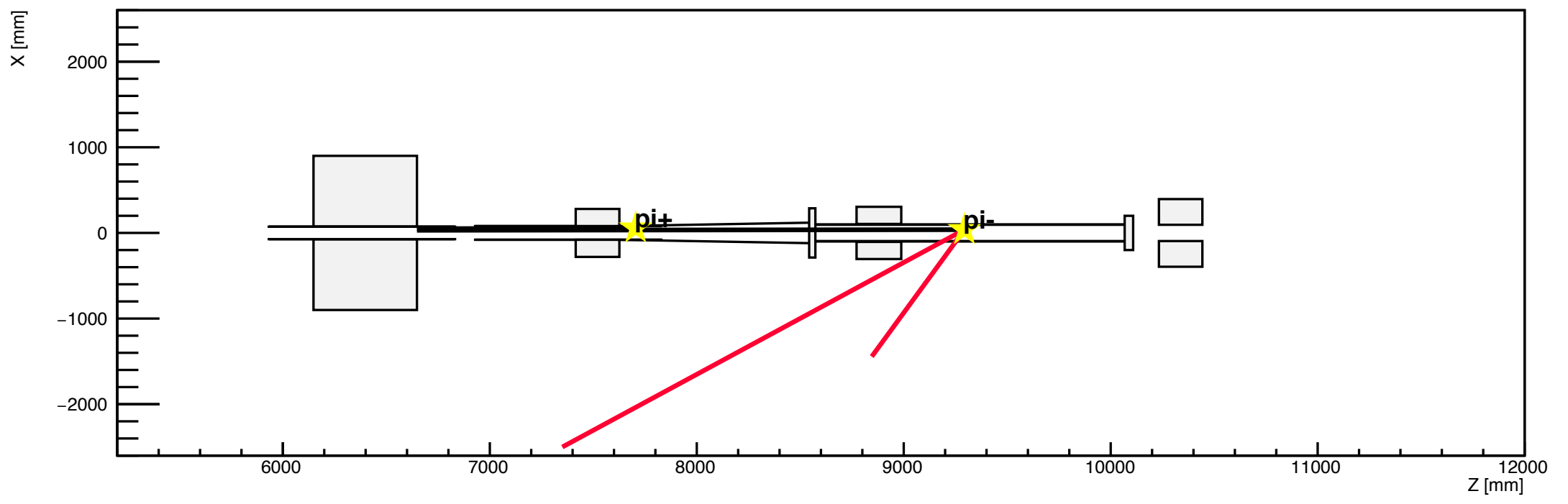

h1

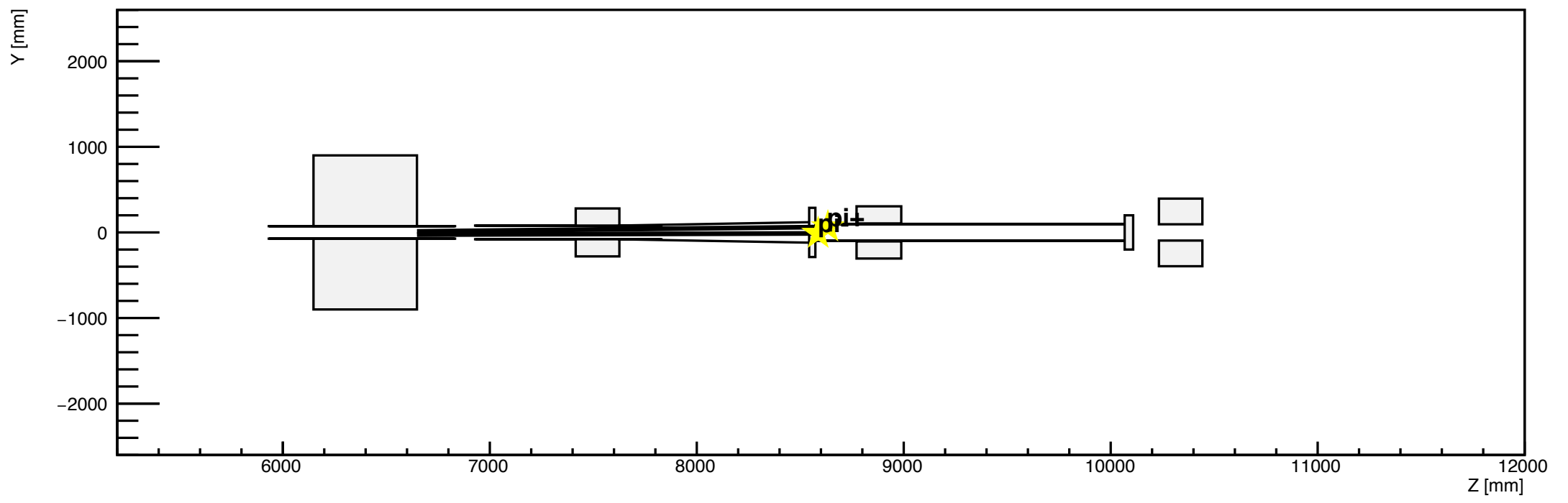

h2

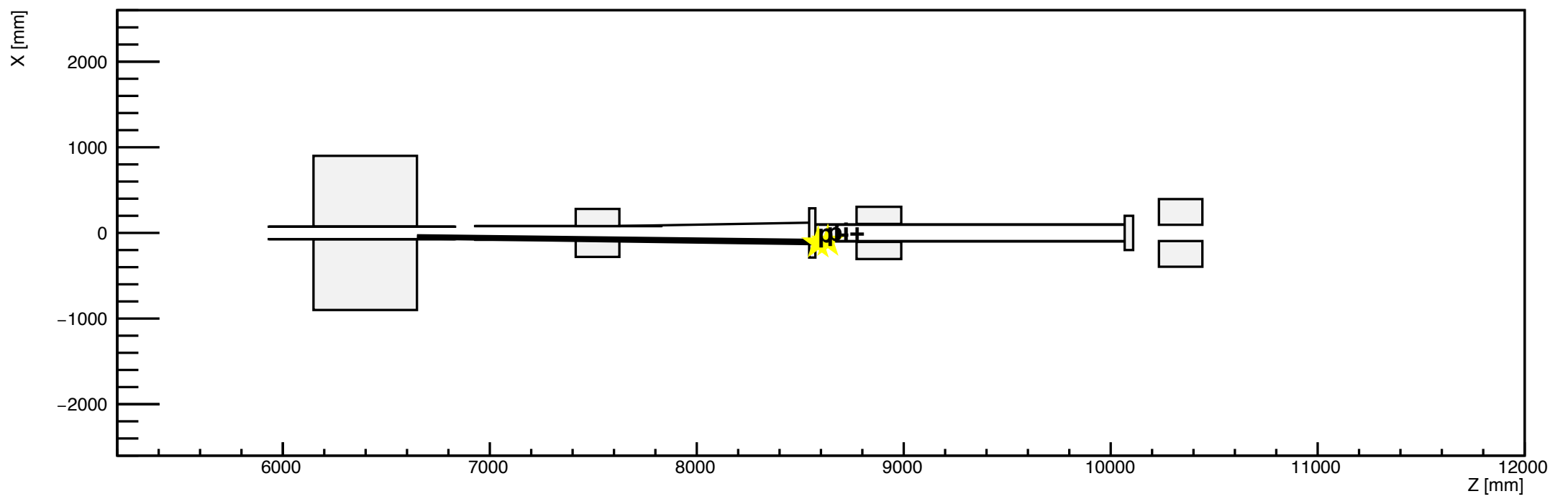

h1

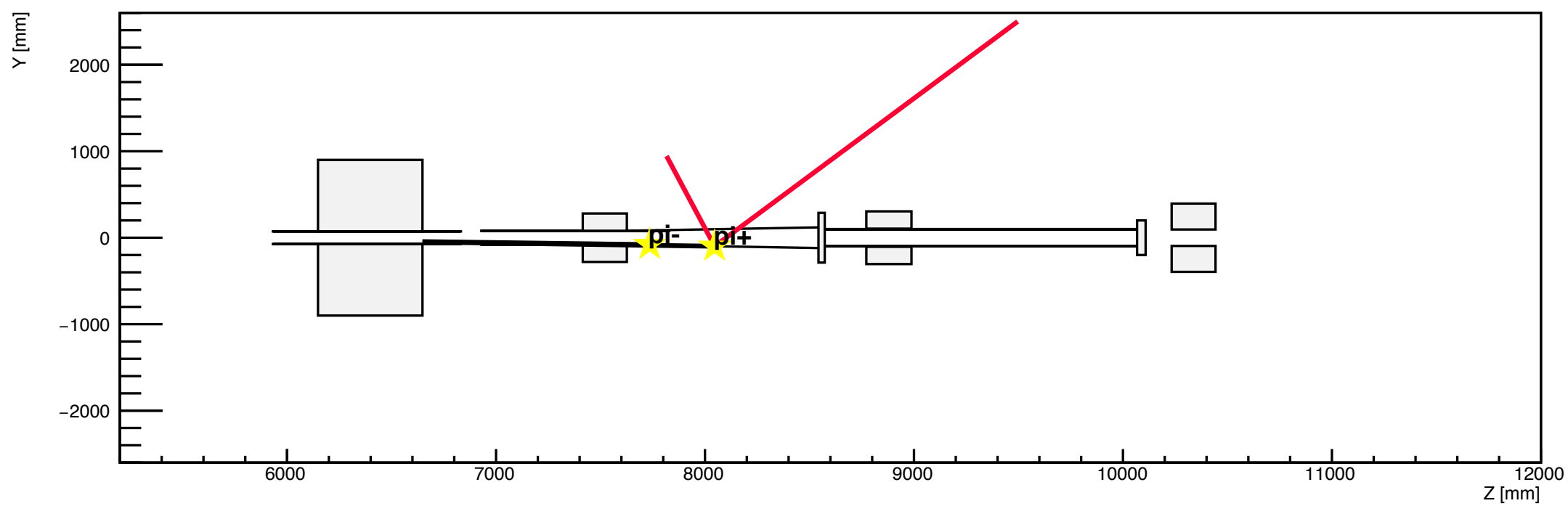

h2

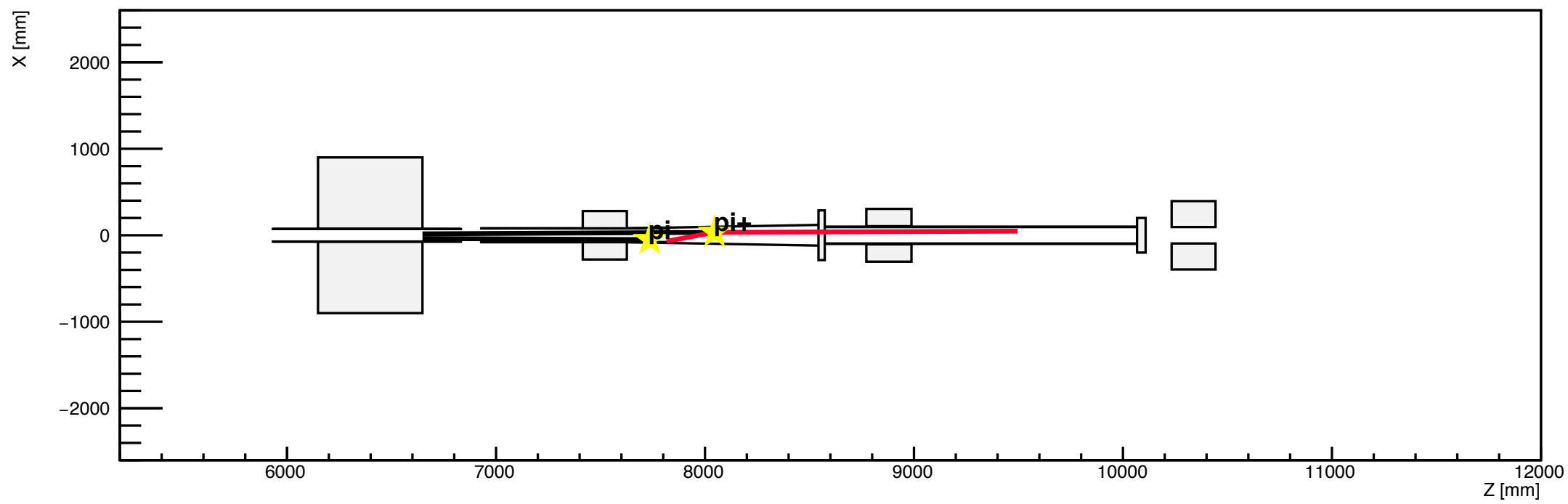

h1

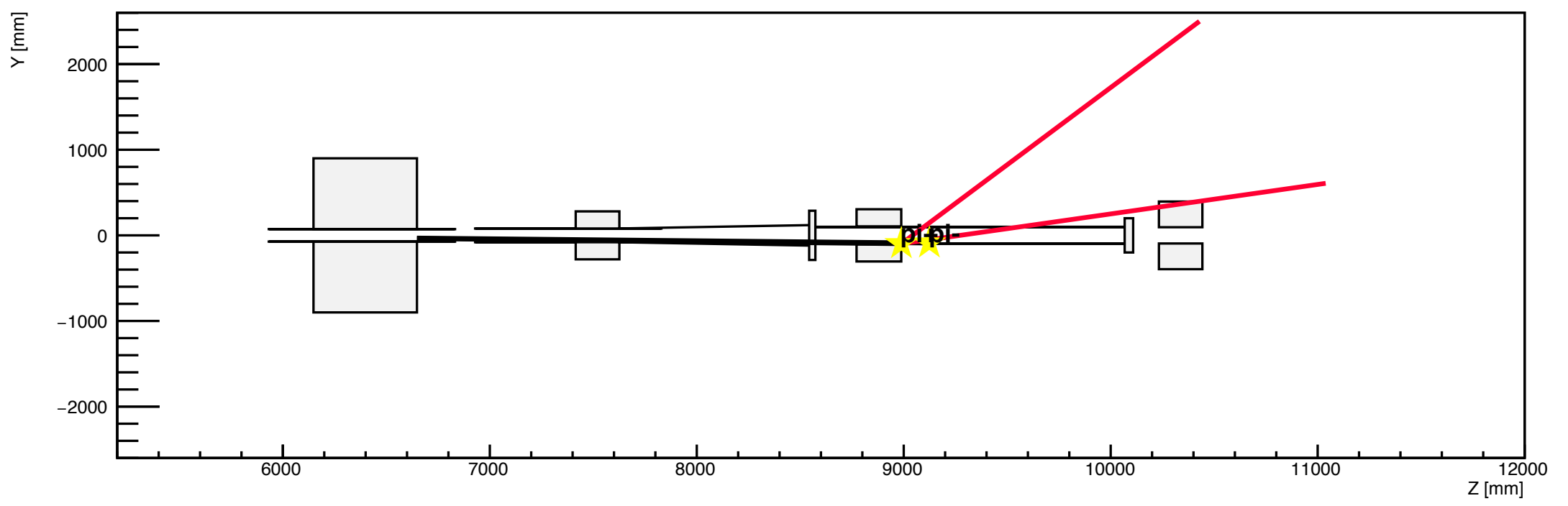

h2

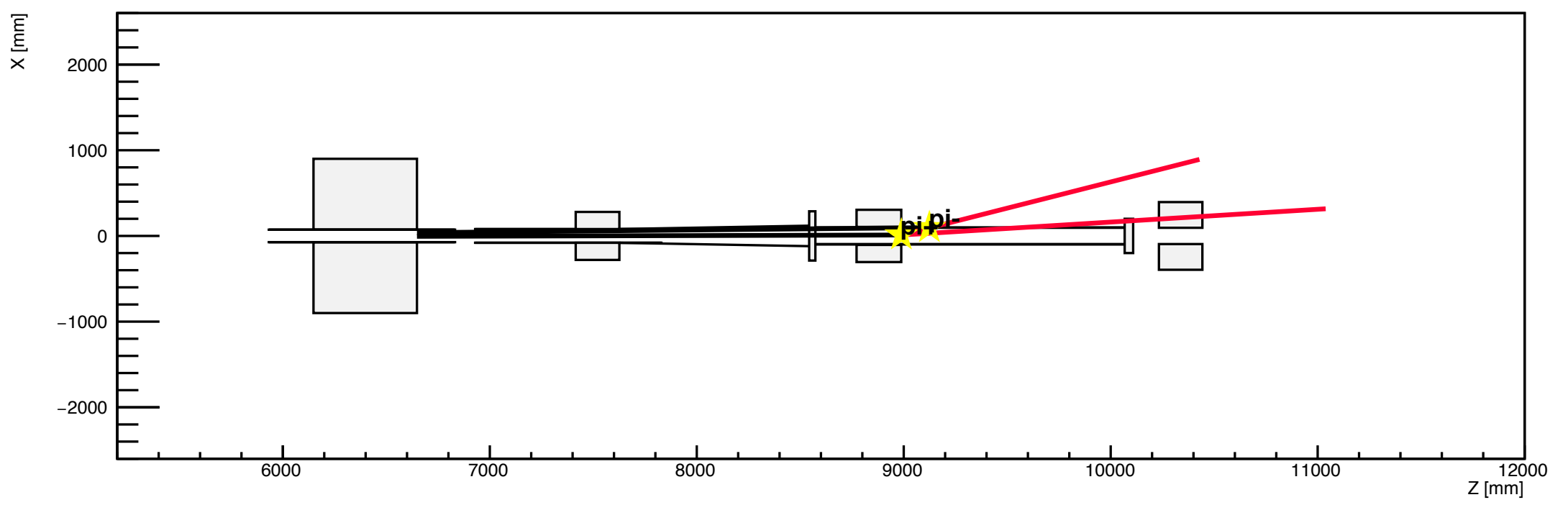

h1

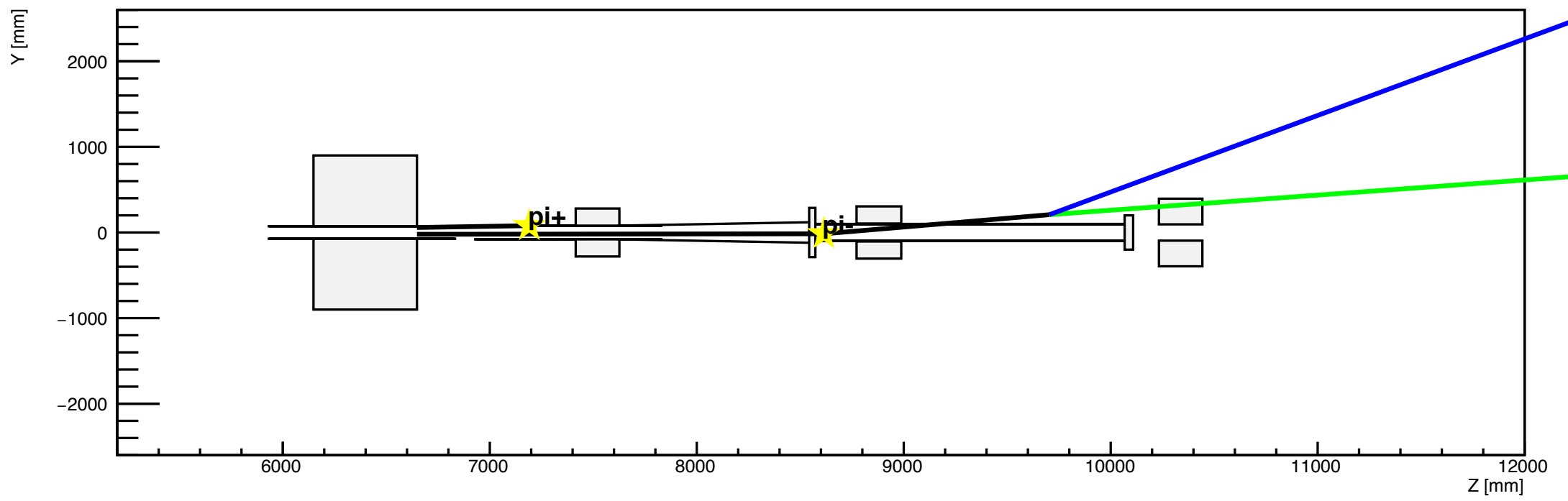

h2

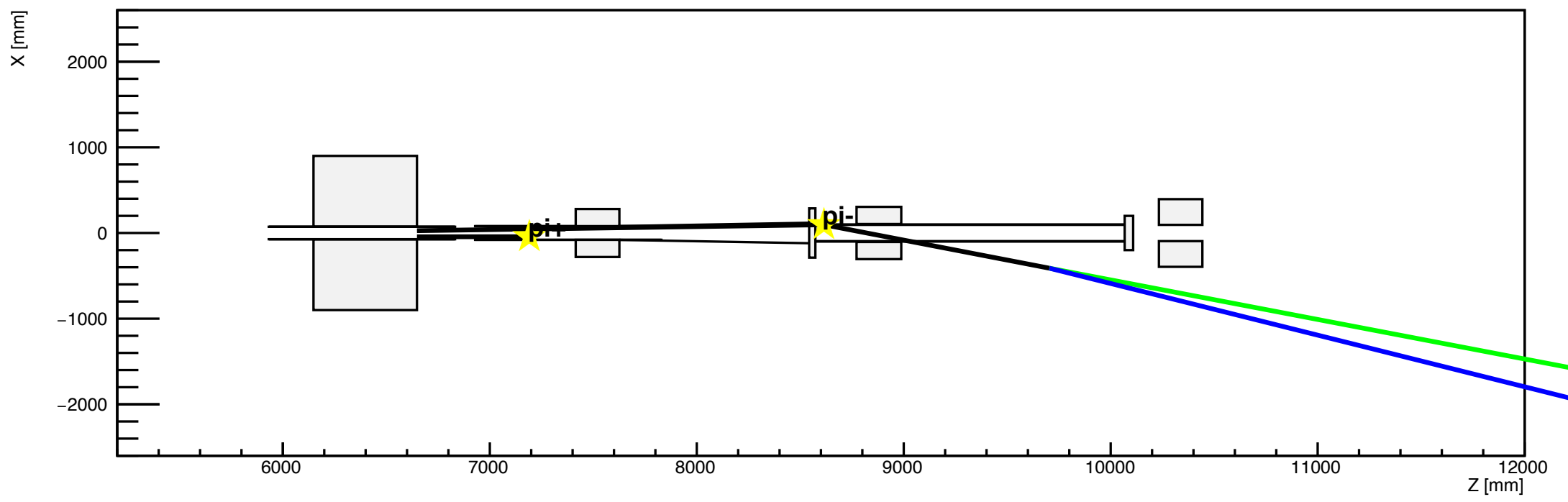

h1

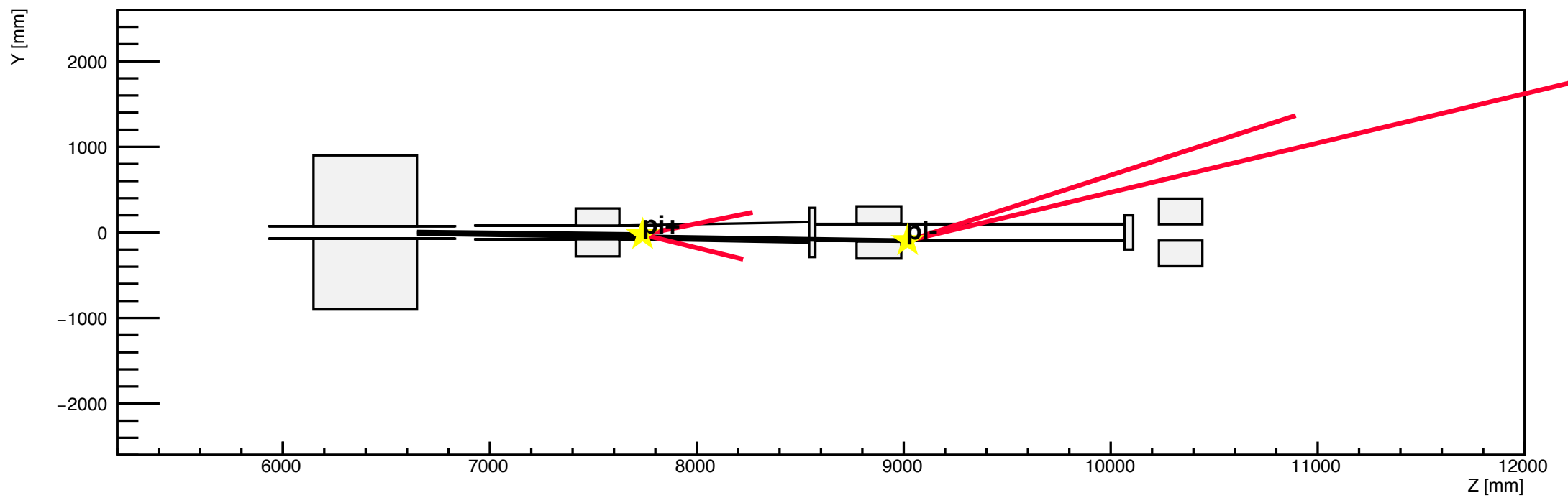

h2

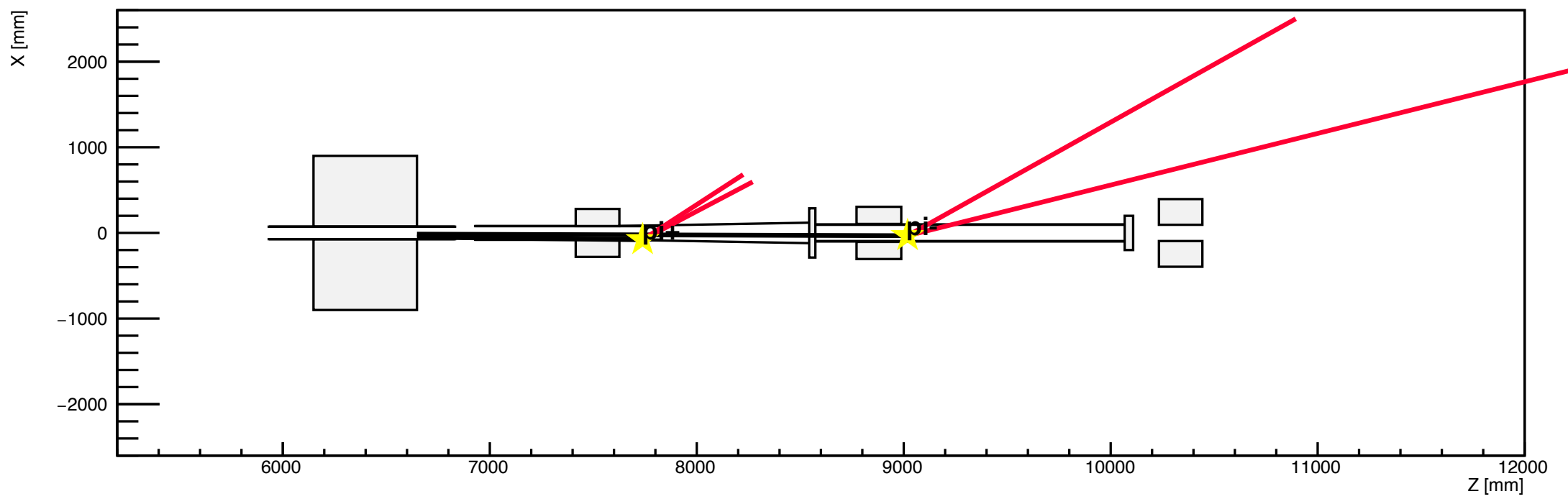

h1

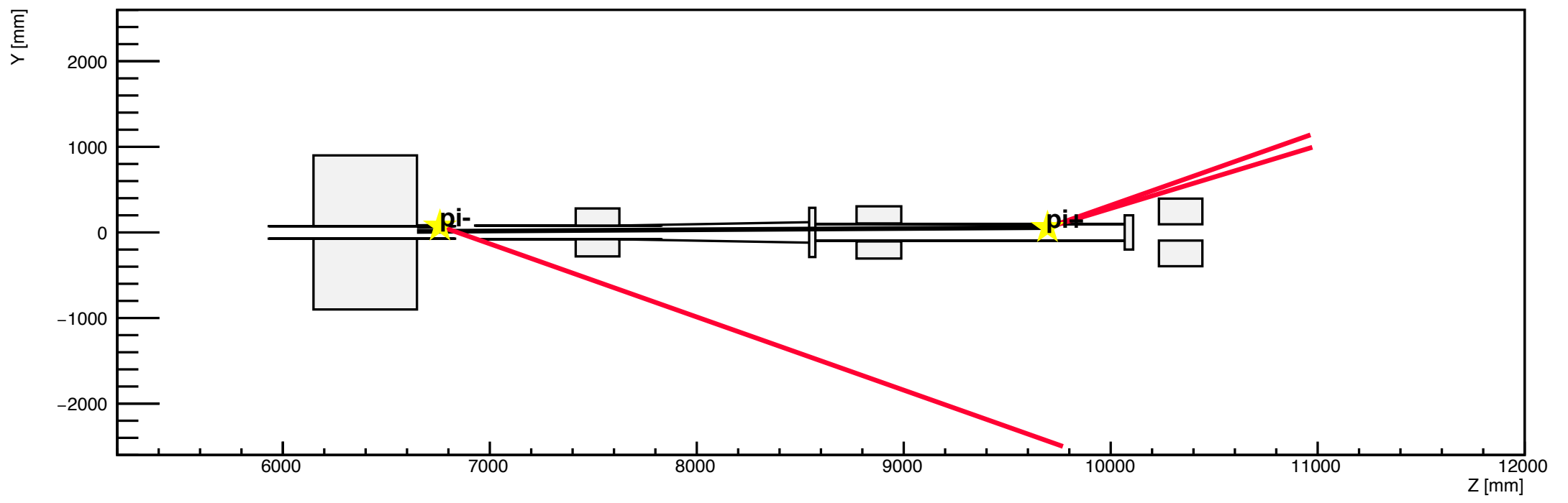

h2

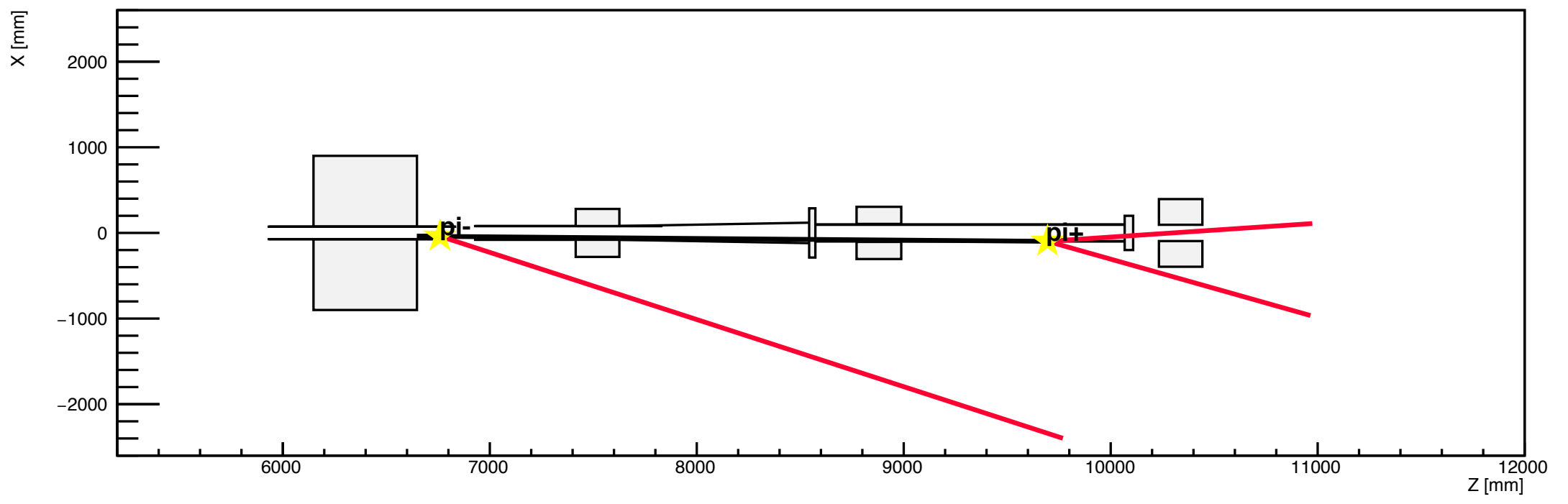

h1

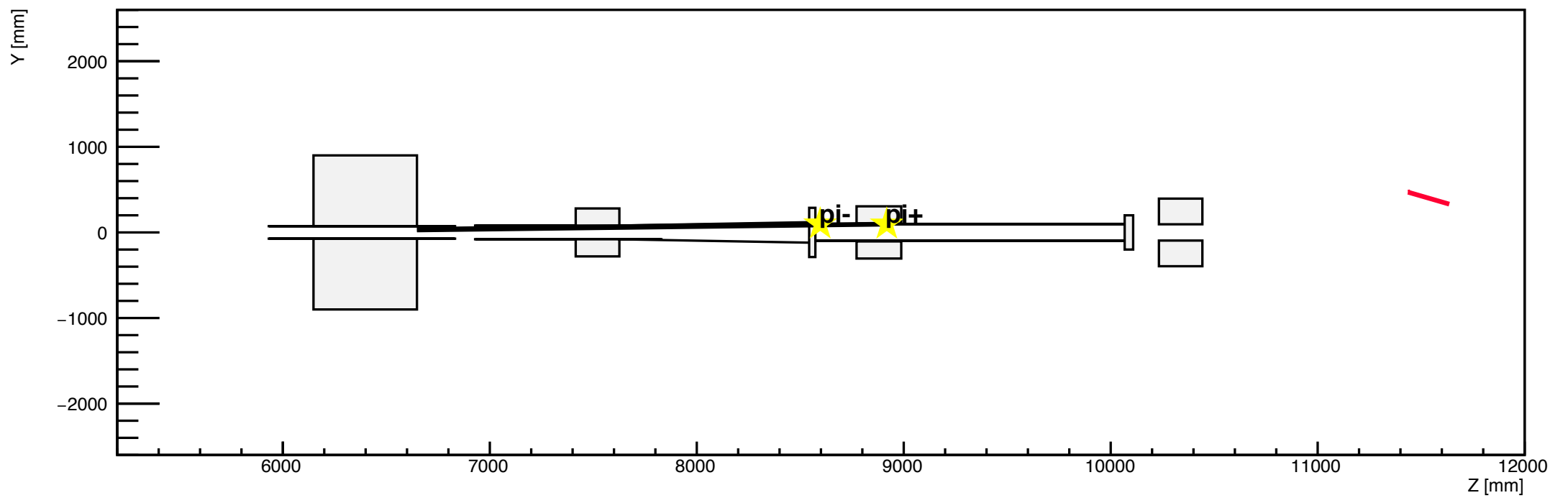

h2

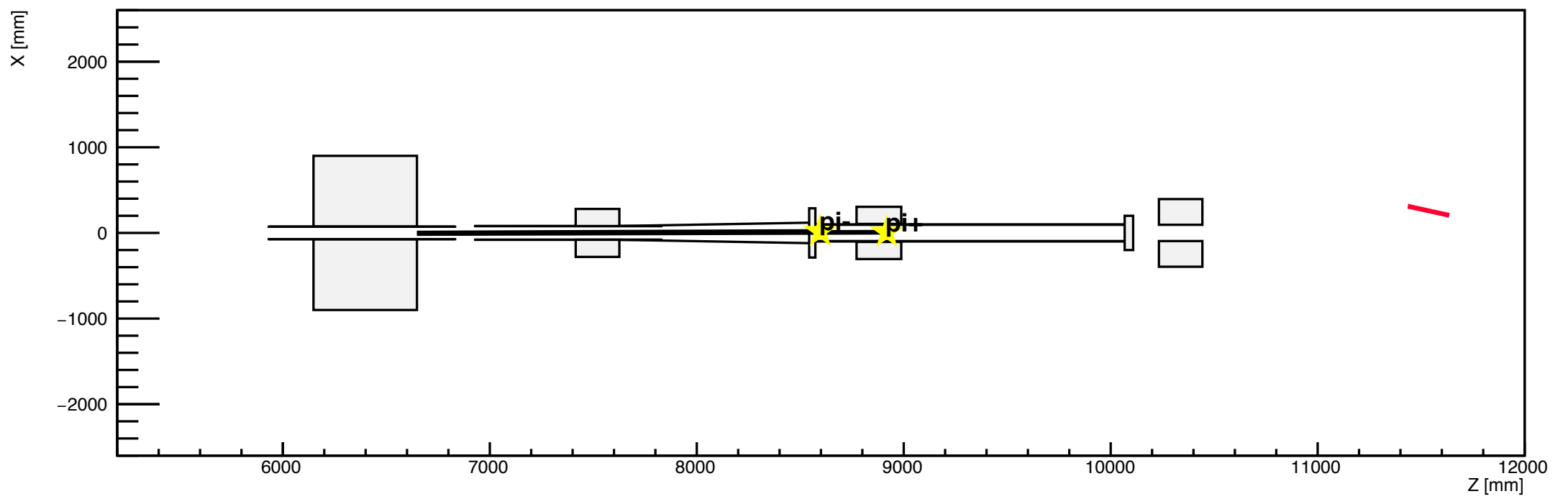

h1

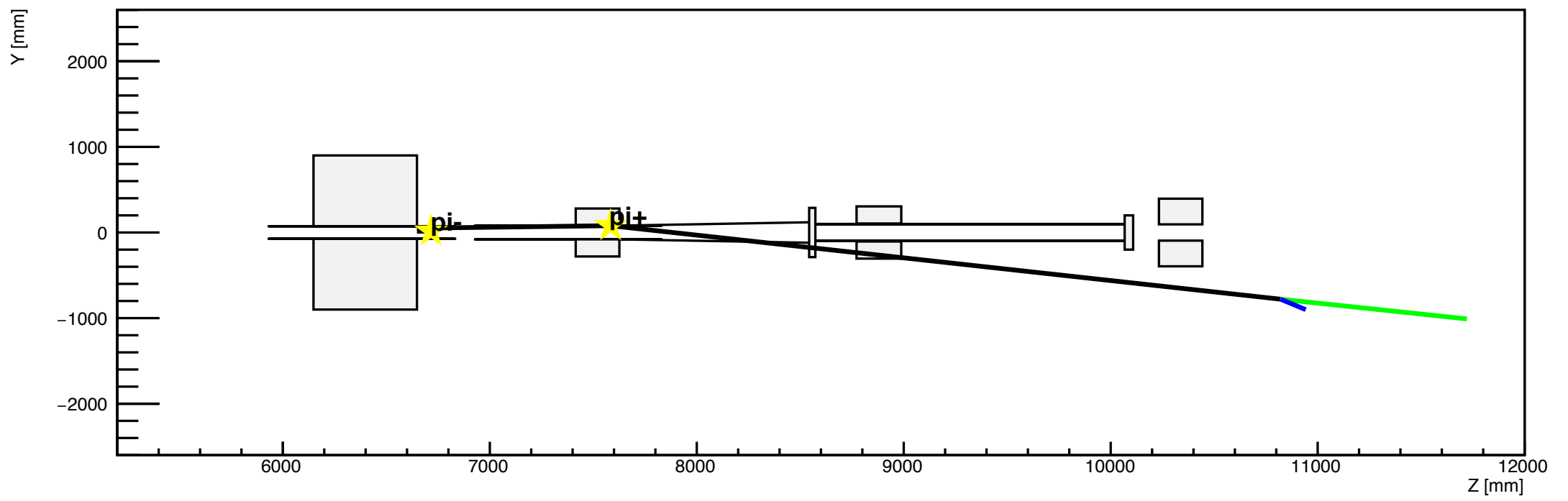

h2

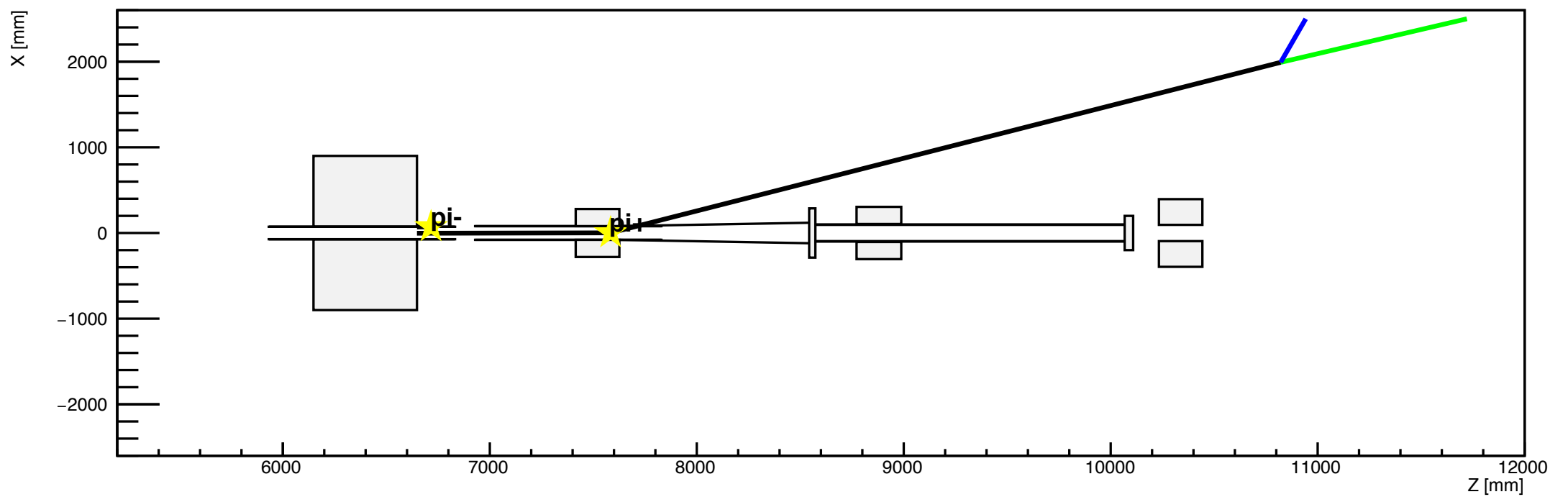

h1

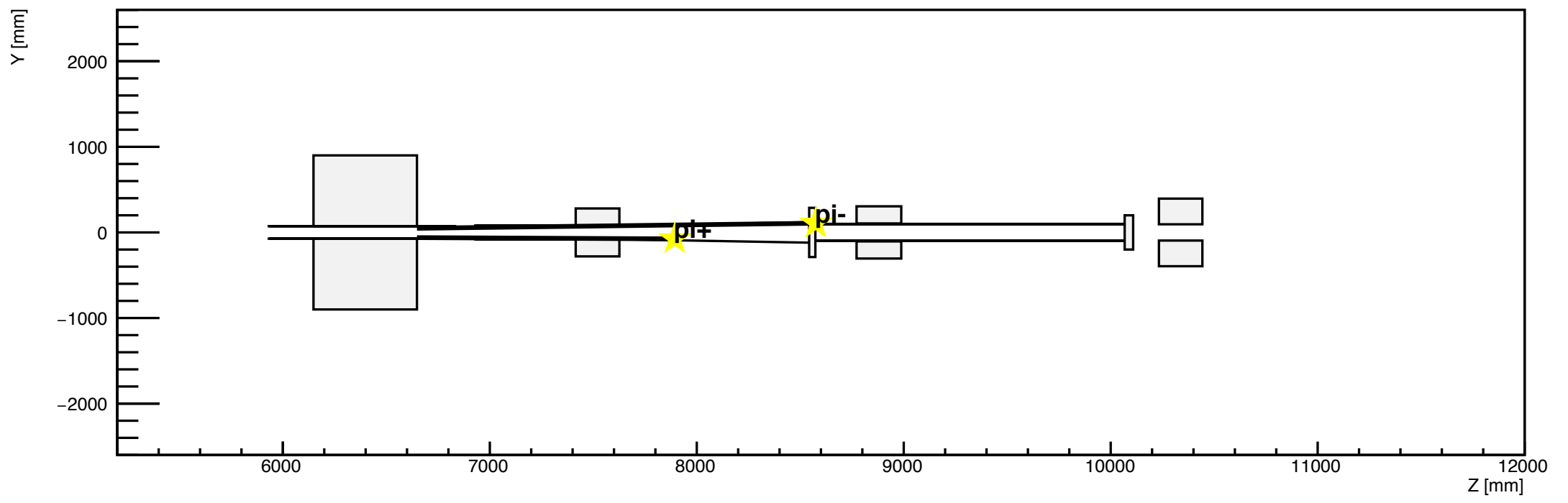

h2

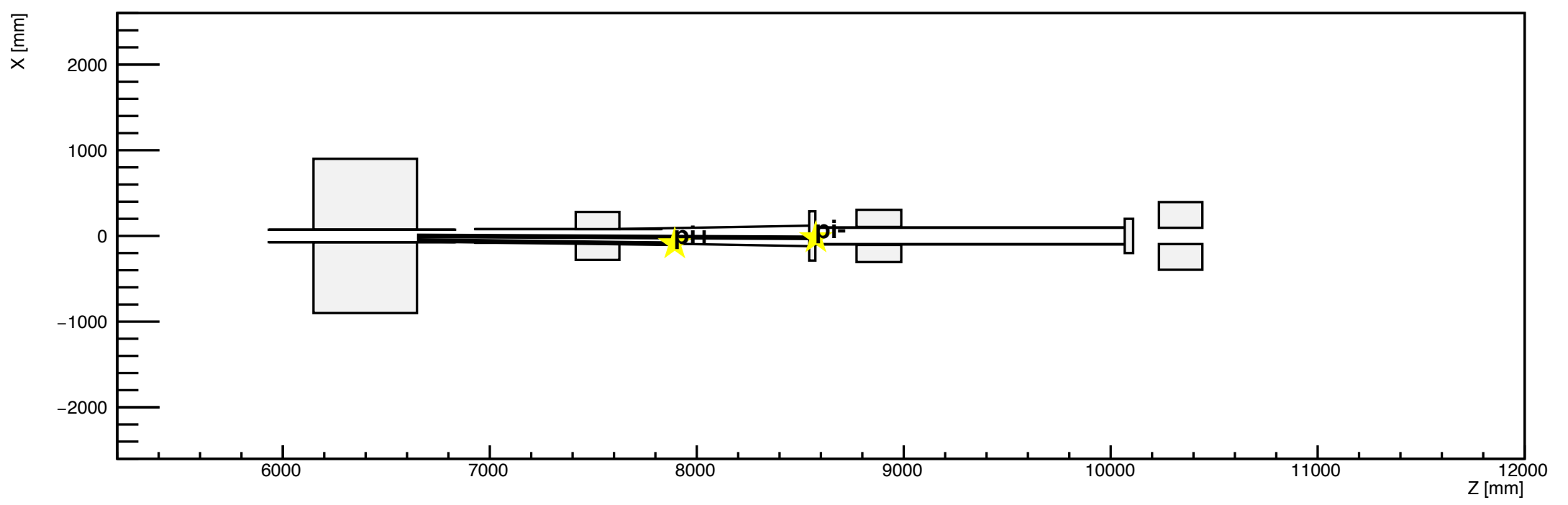

h1

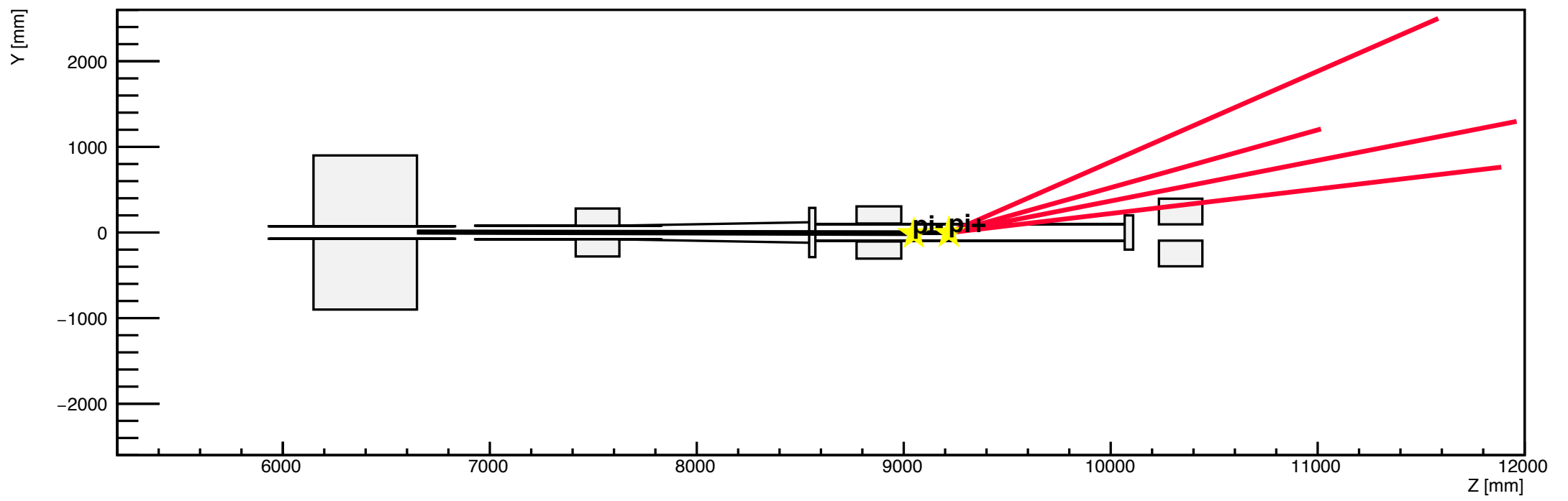

h2

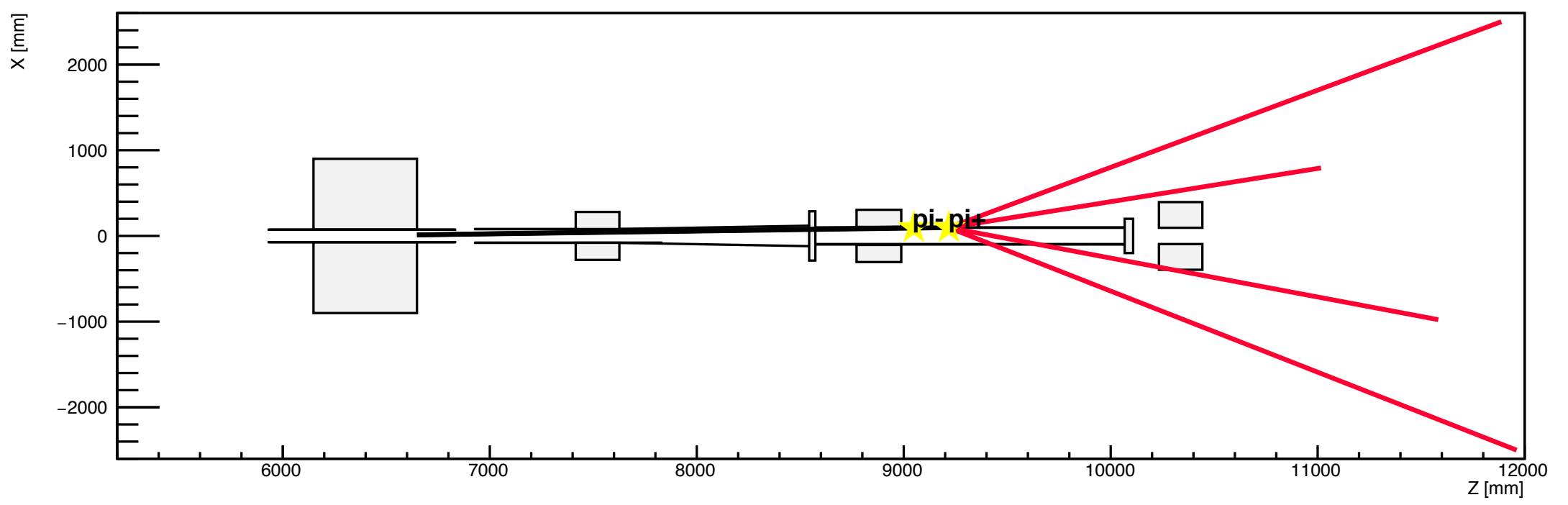

h1

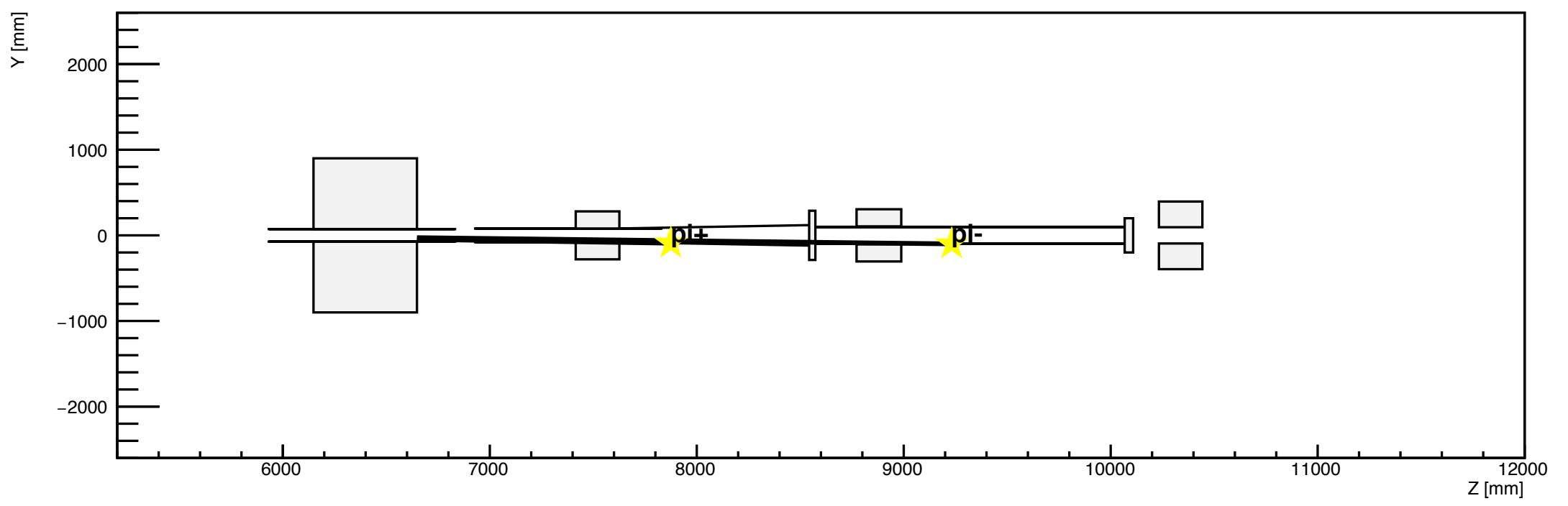

h2

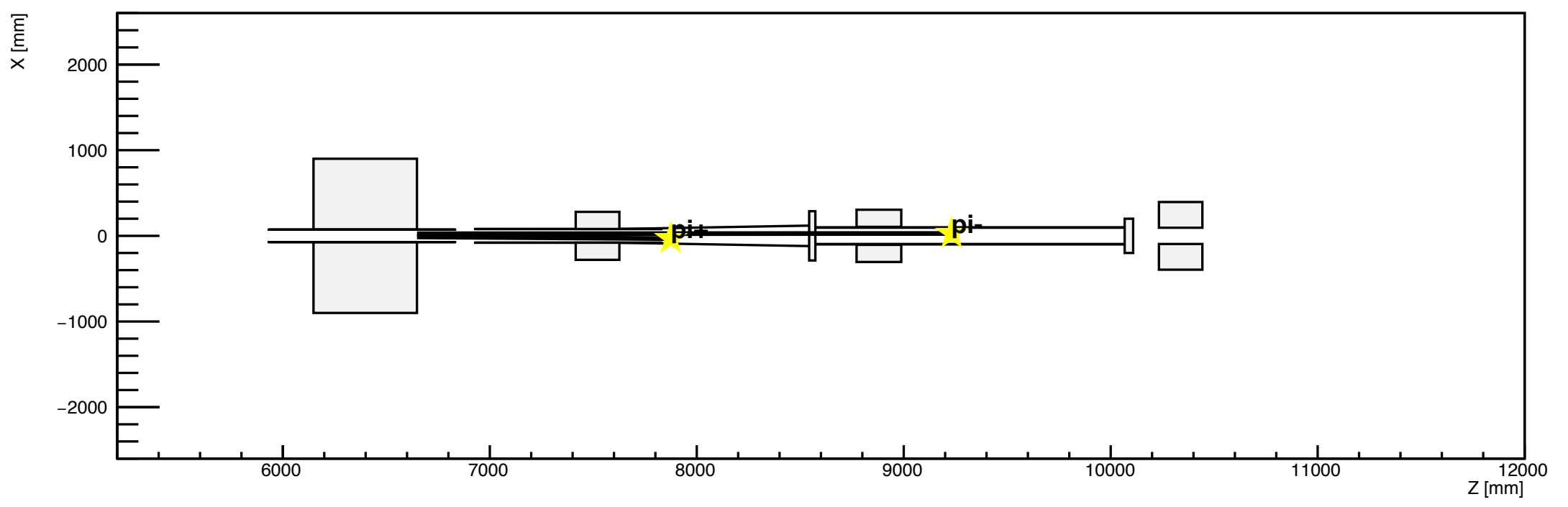

h1

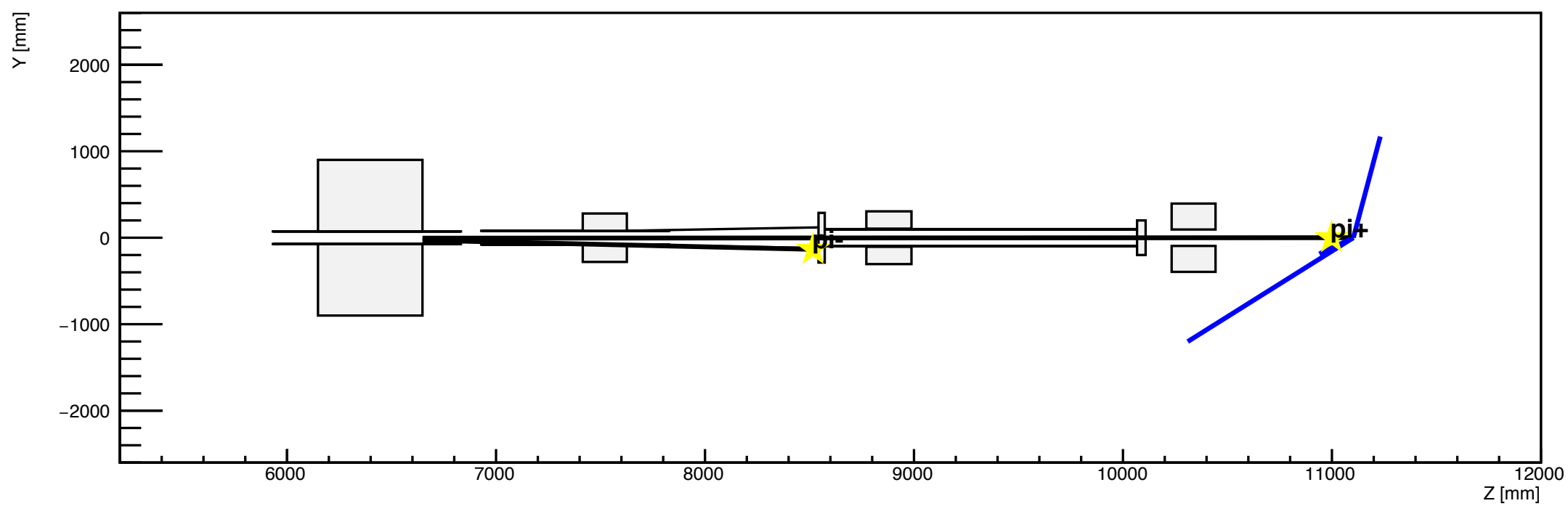

h2

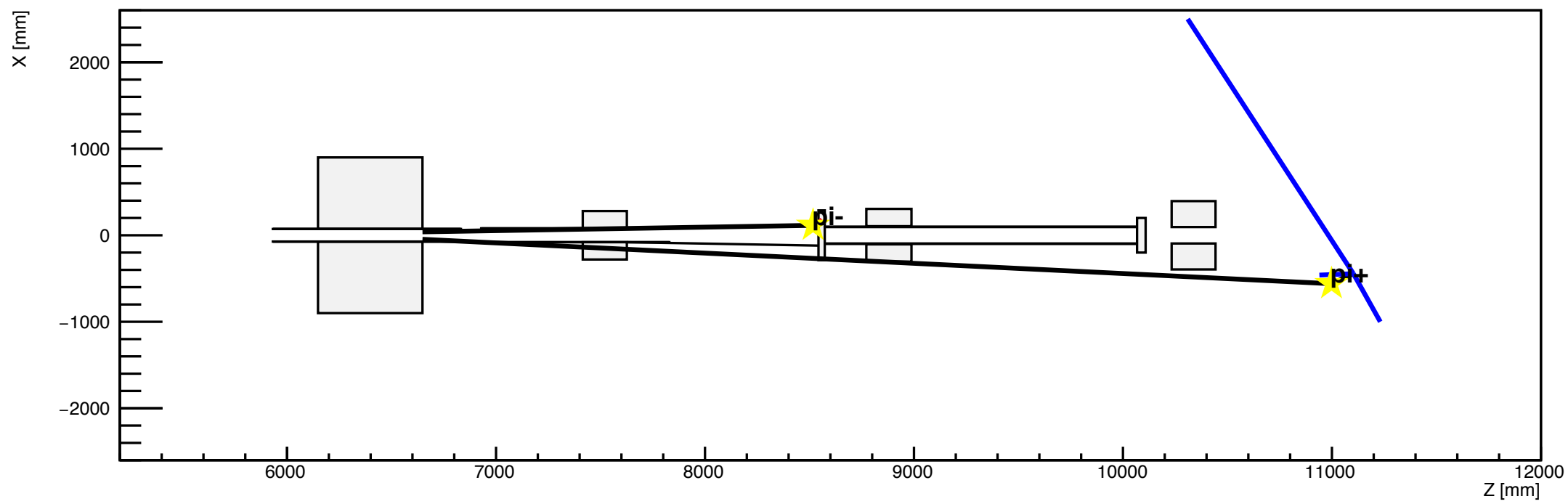

h1

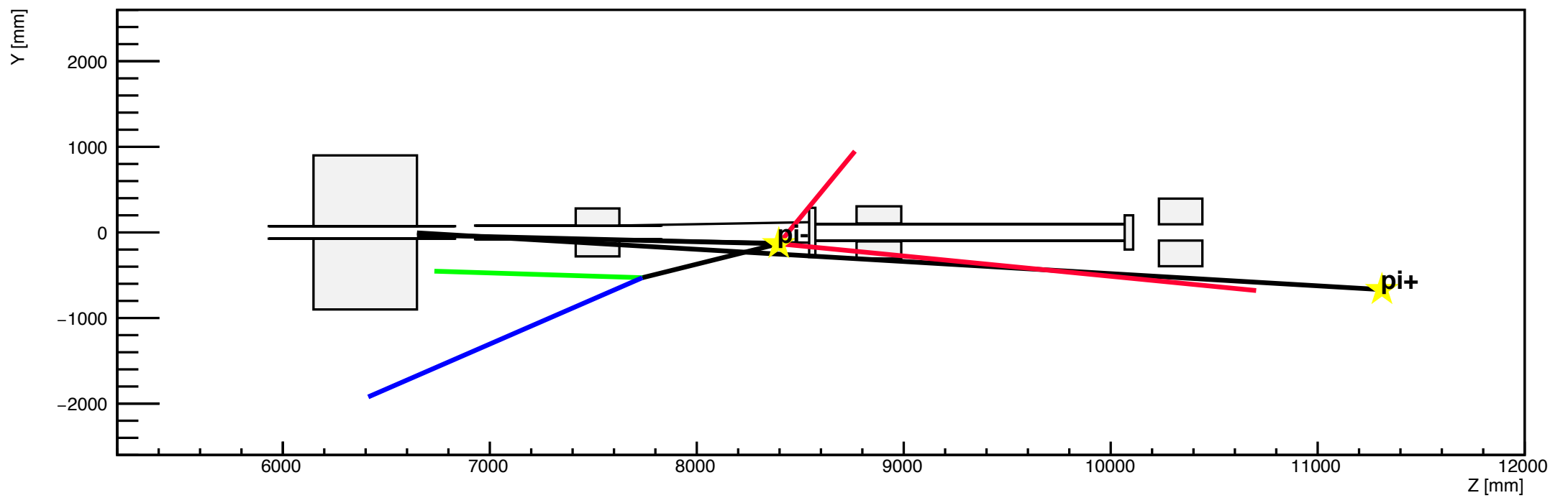

h2

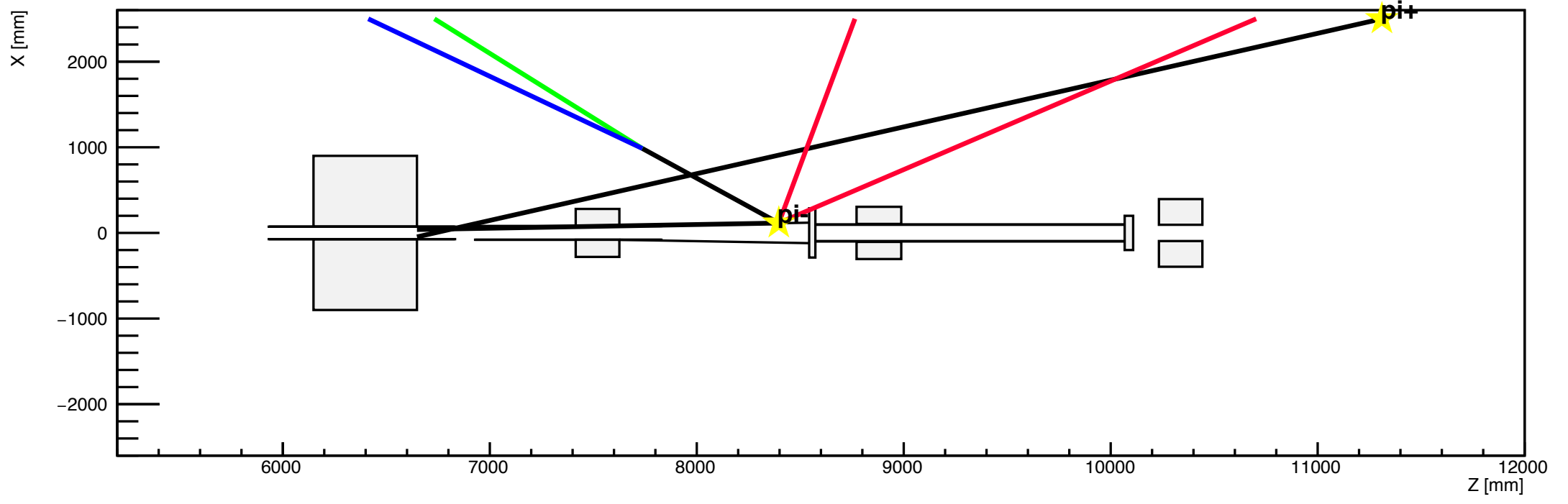

h1

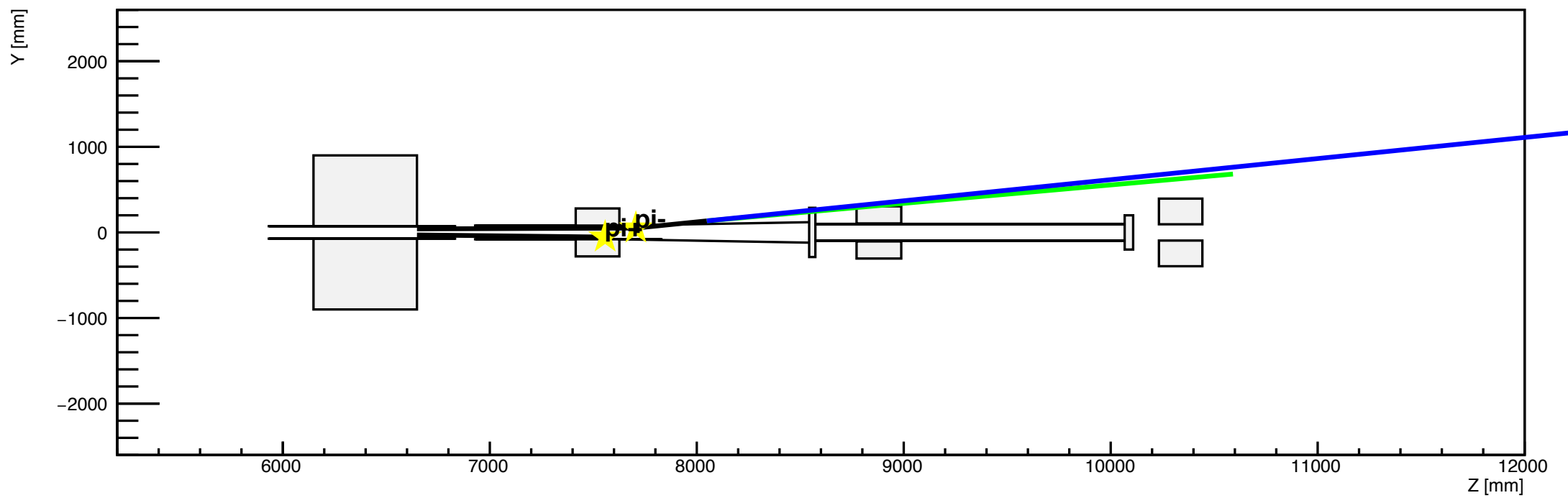

h2

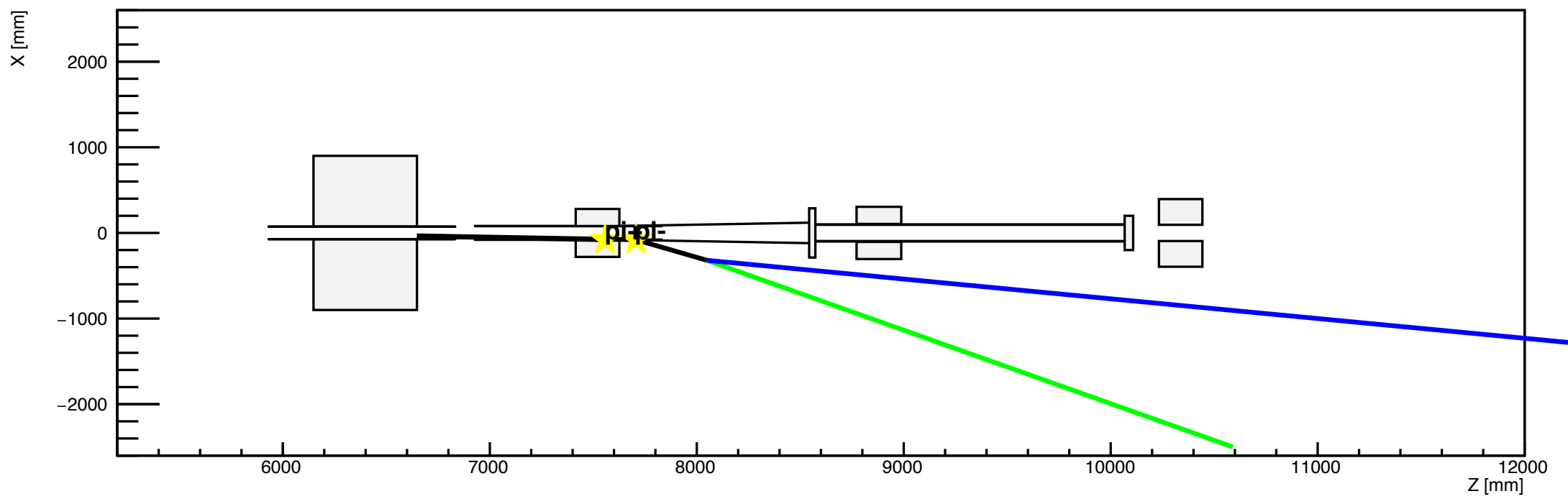

h1

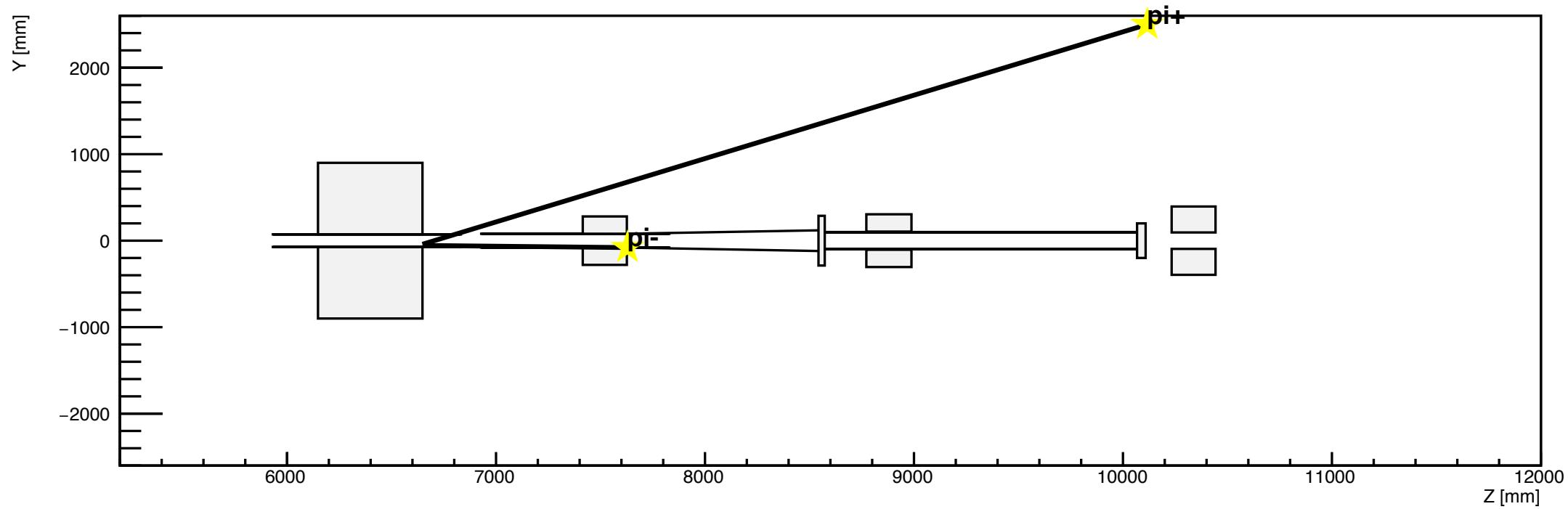

h2

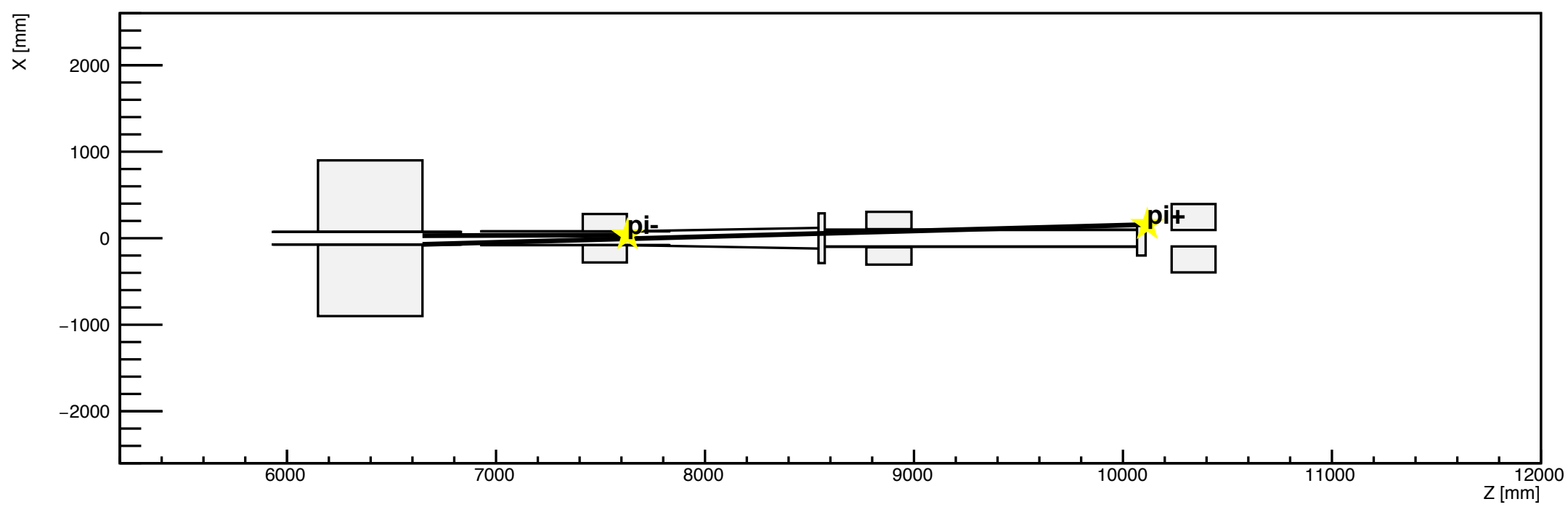

h1

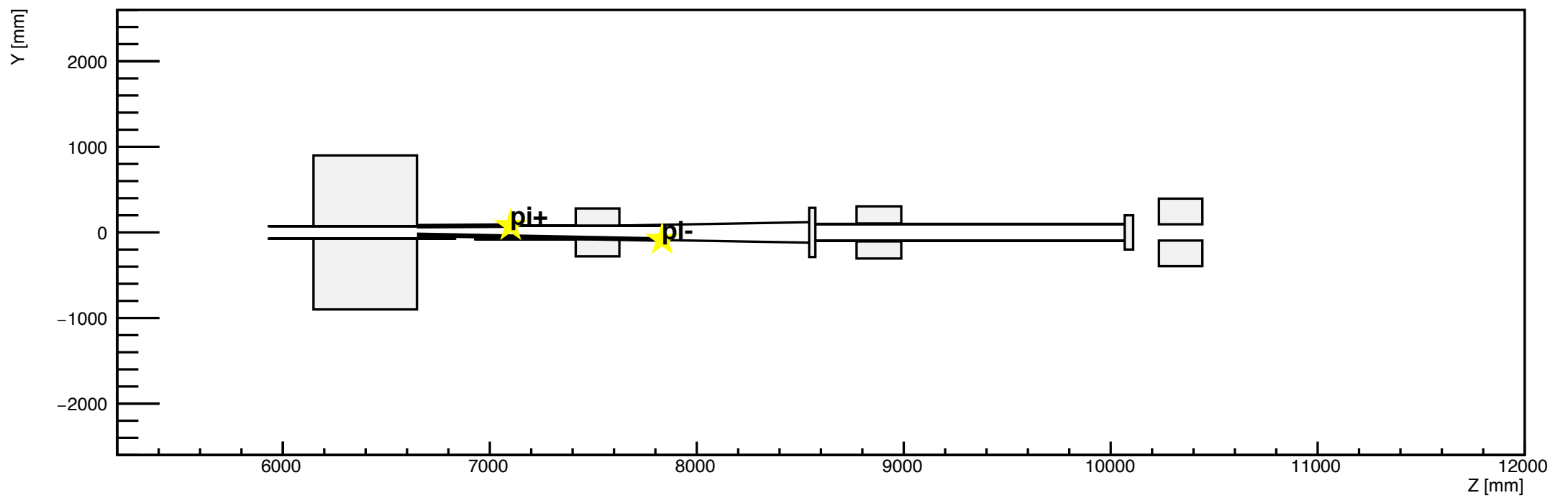

h2

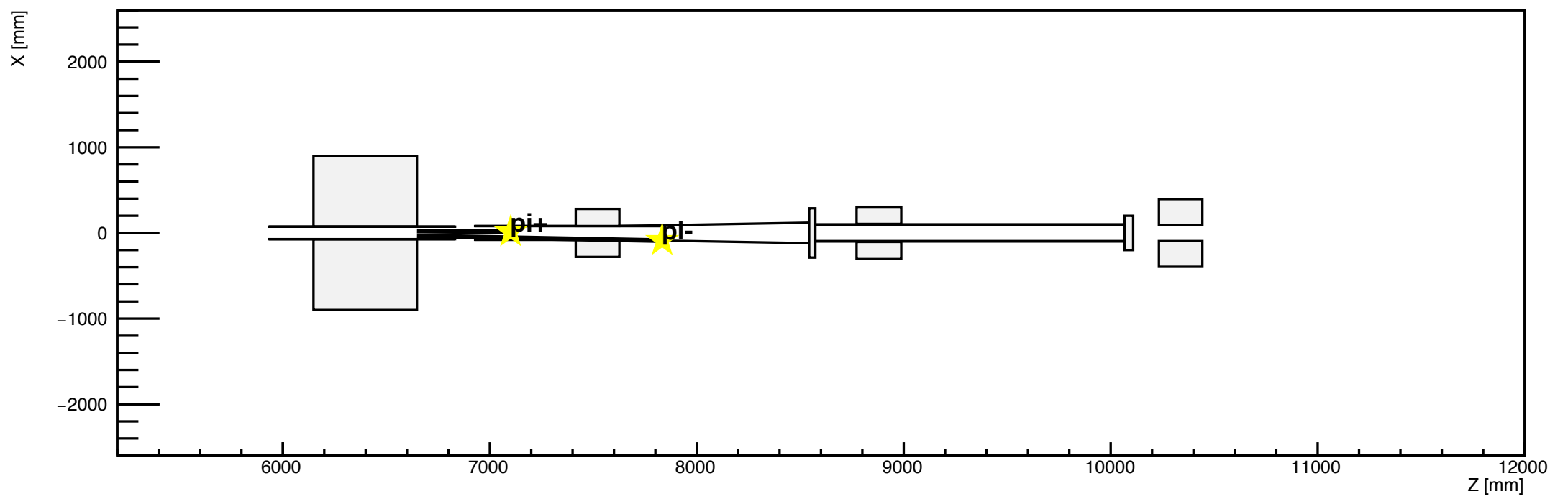

h1

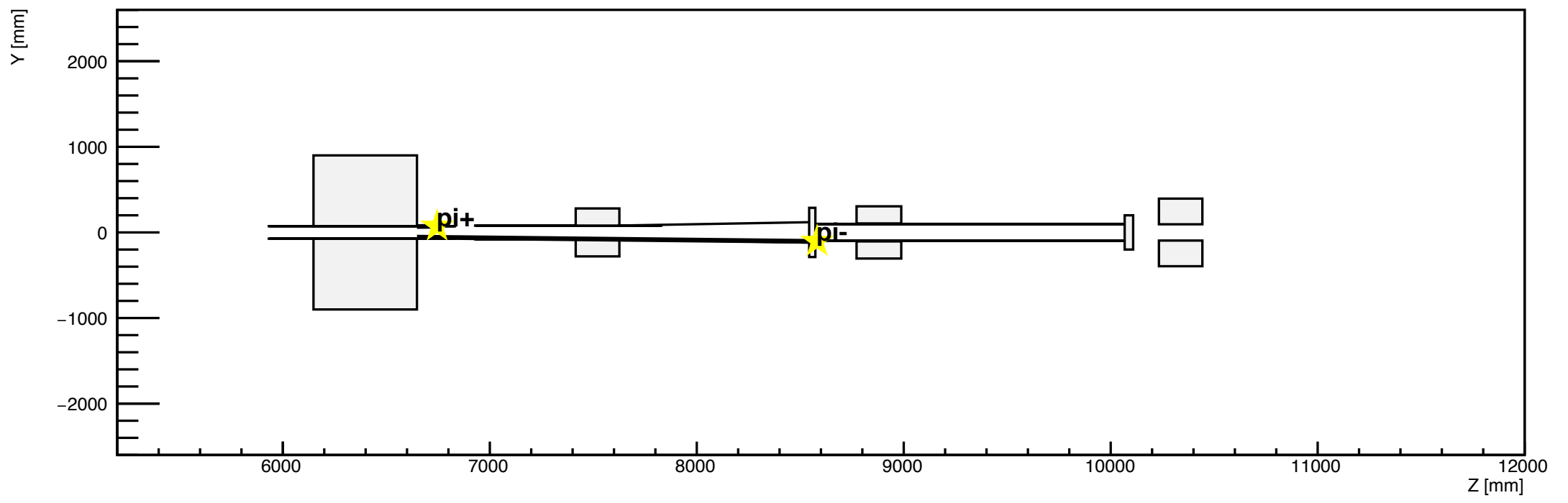

h2

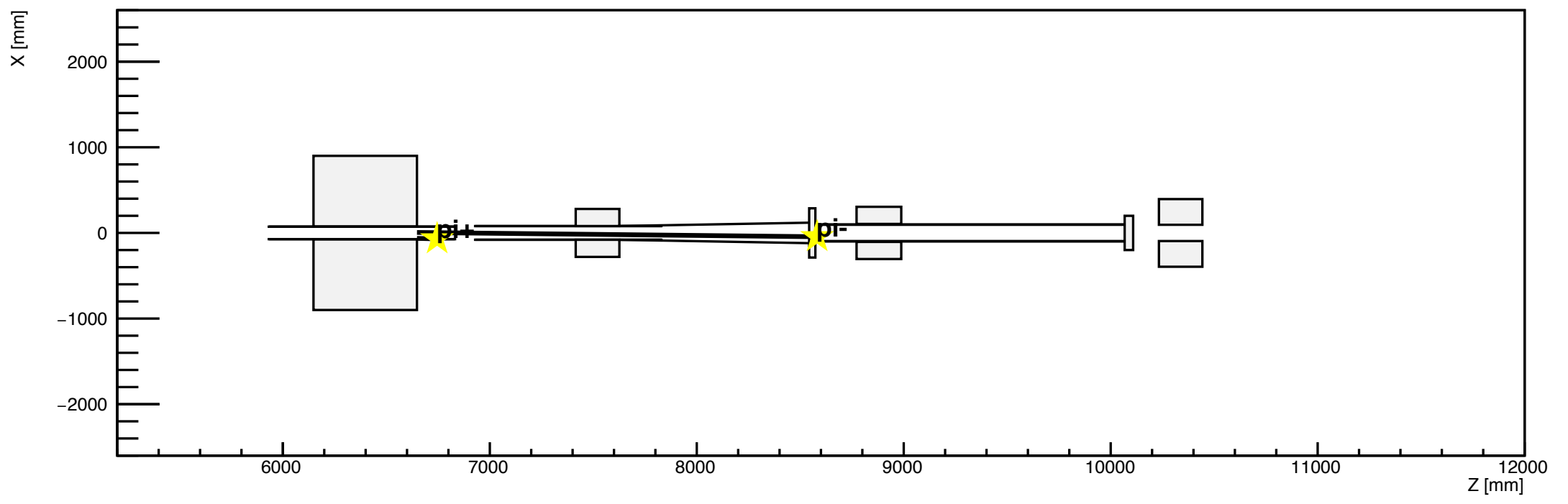

h1

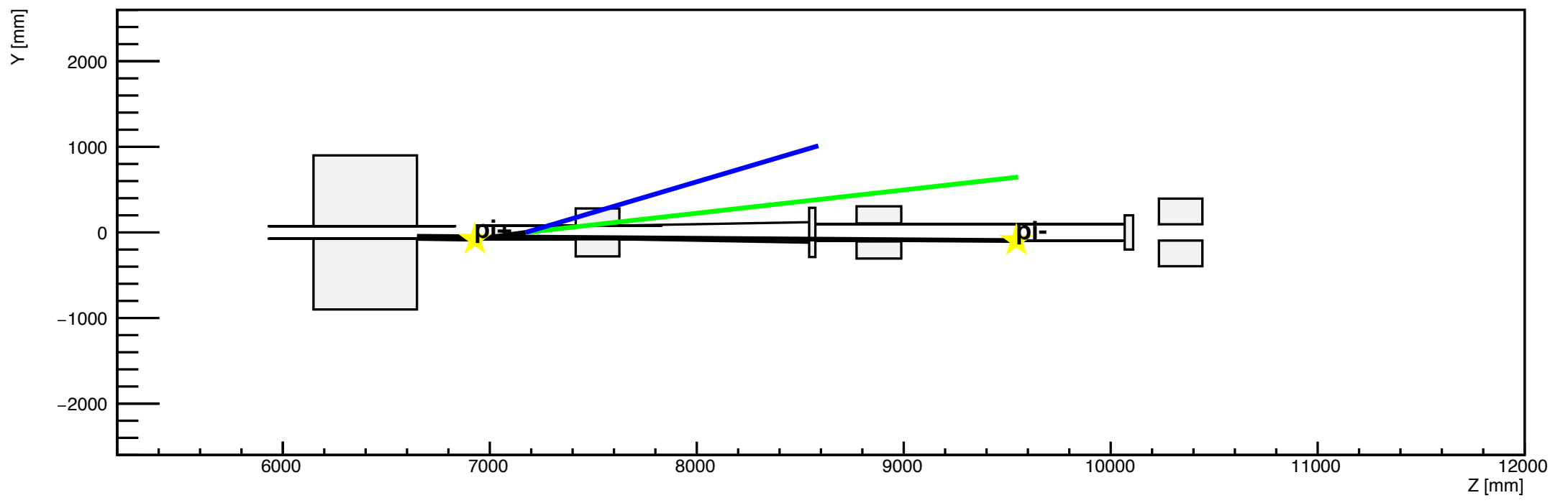

h2

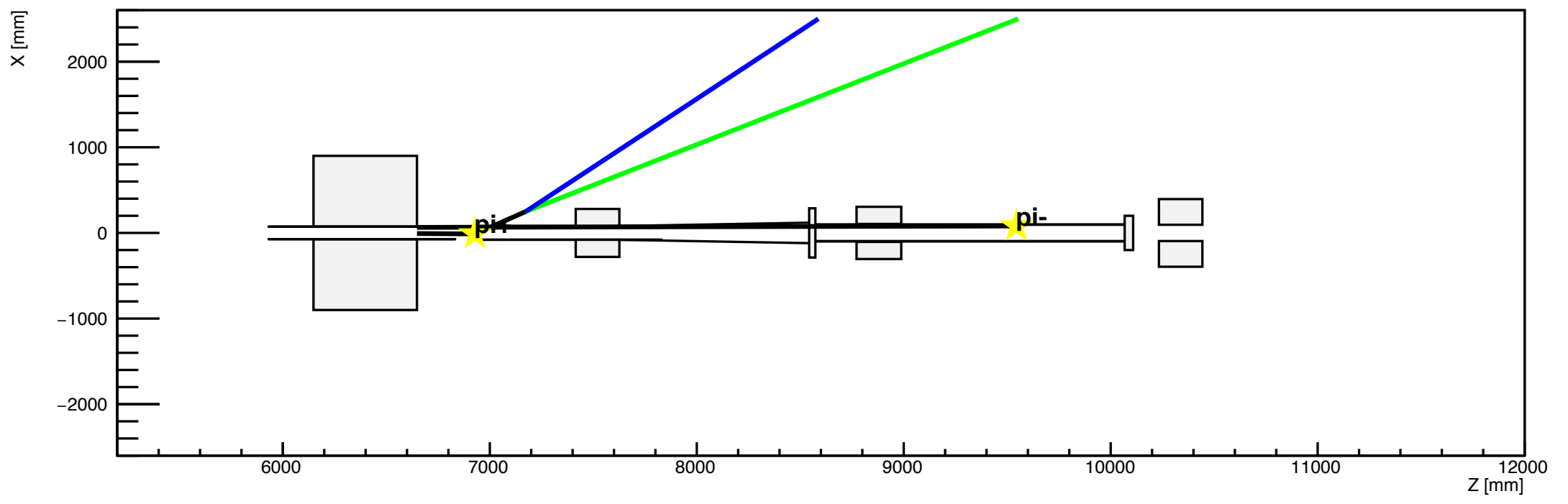

h1

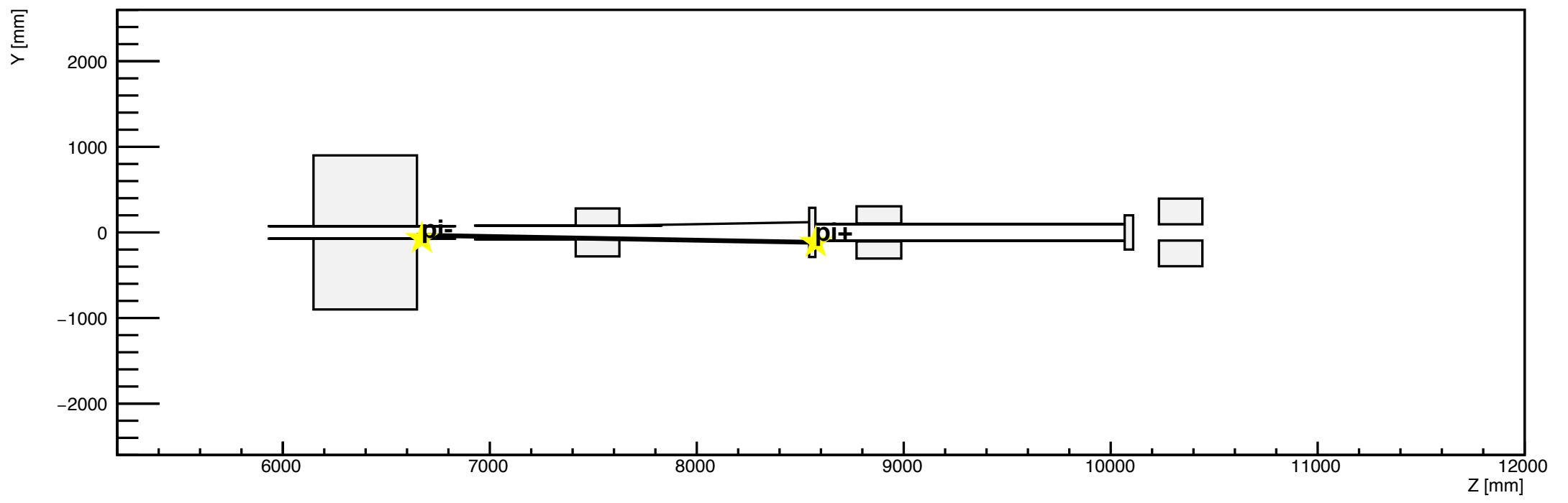

h2

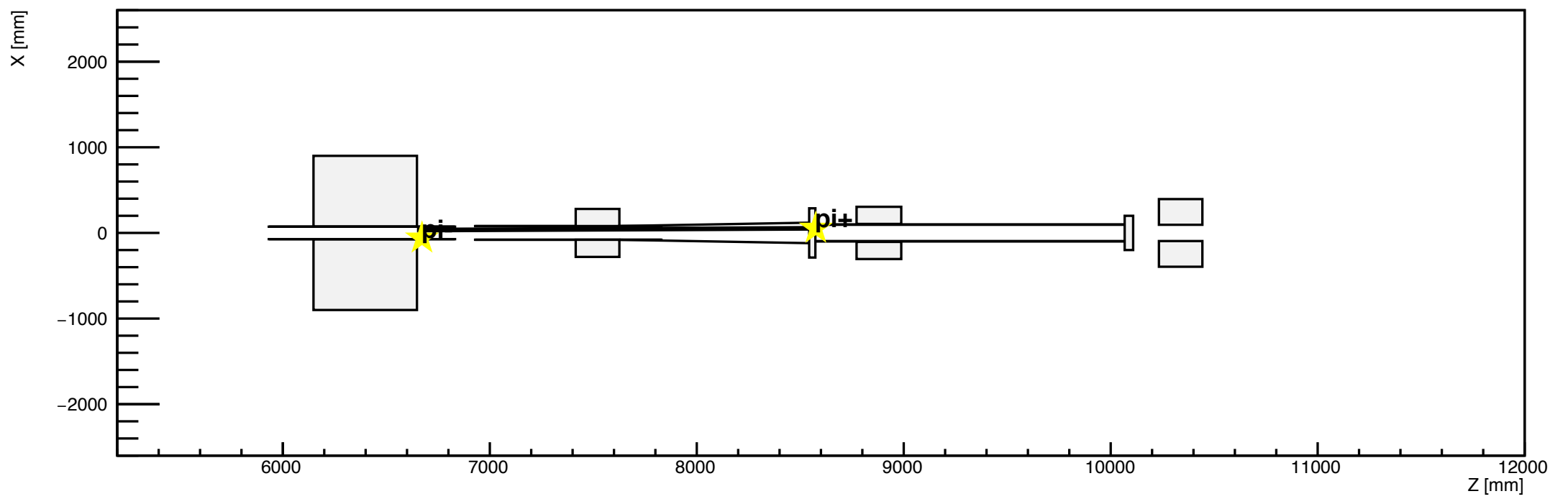

h1

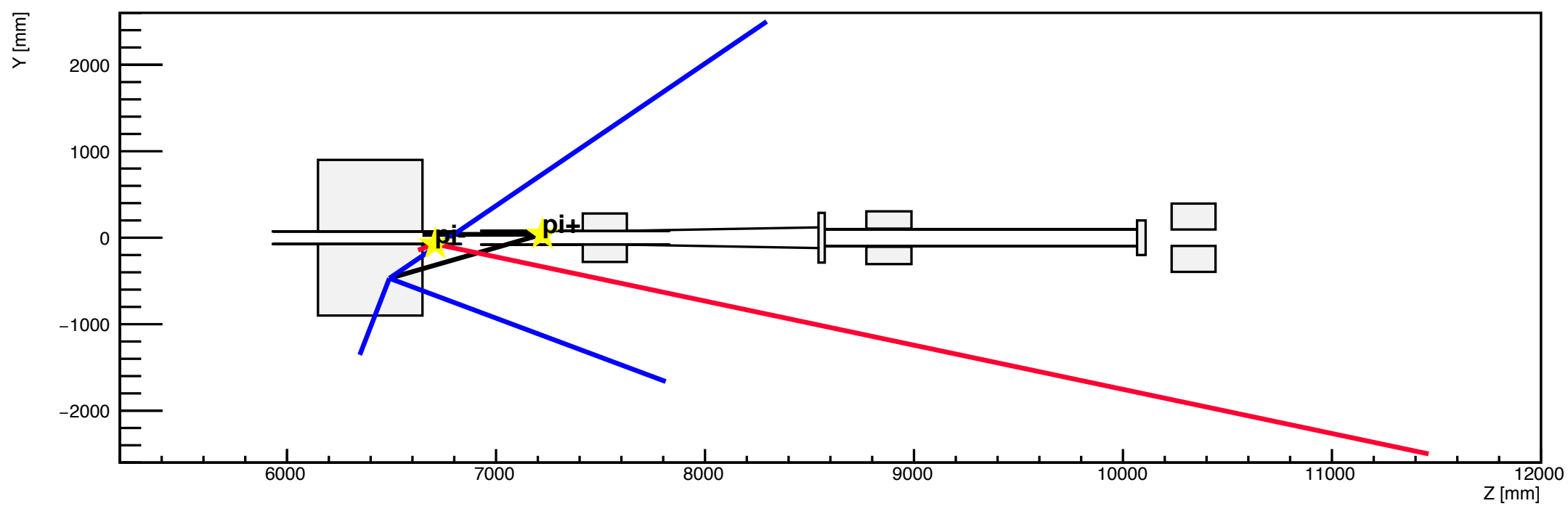

h2

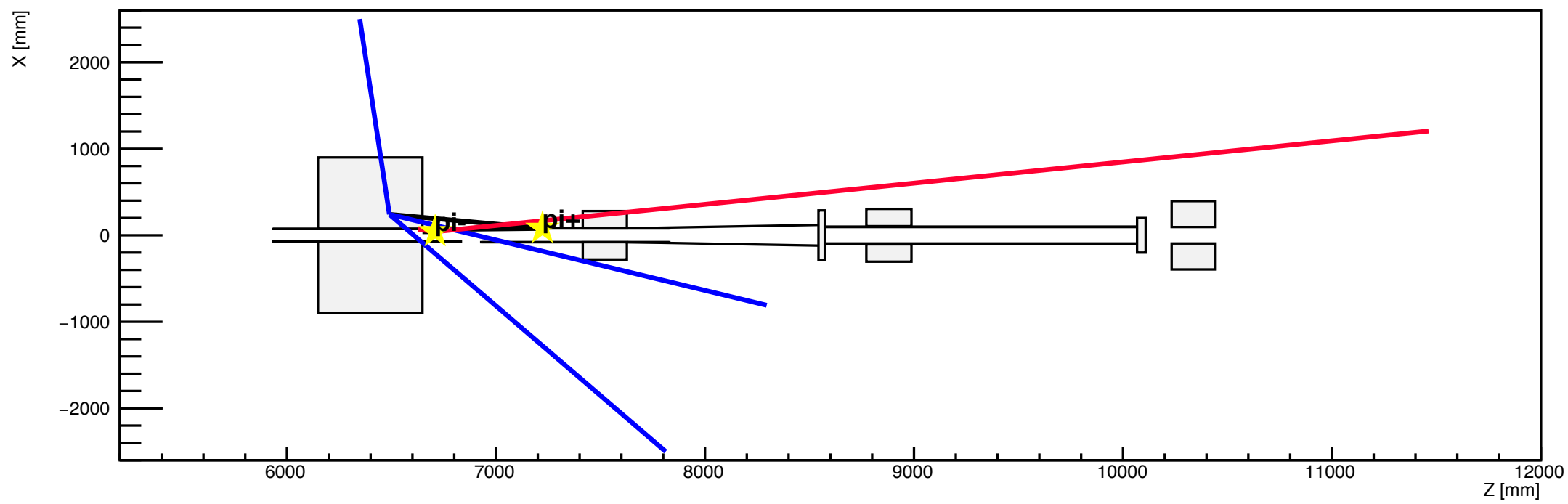

h1

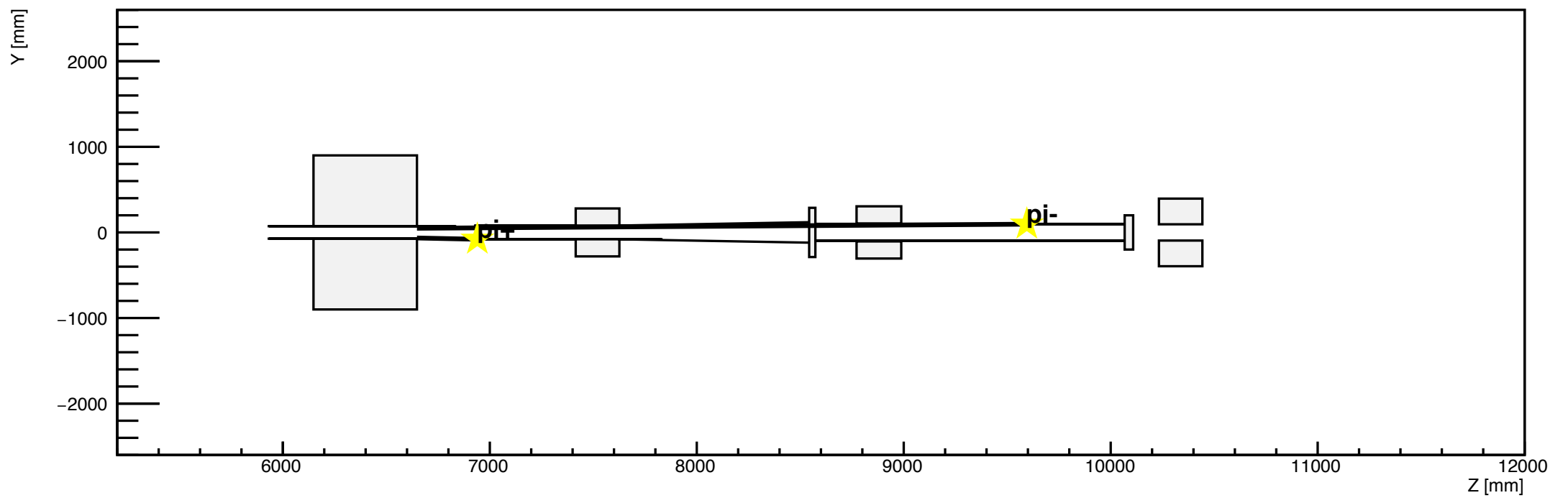

h2

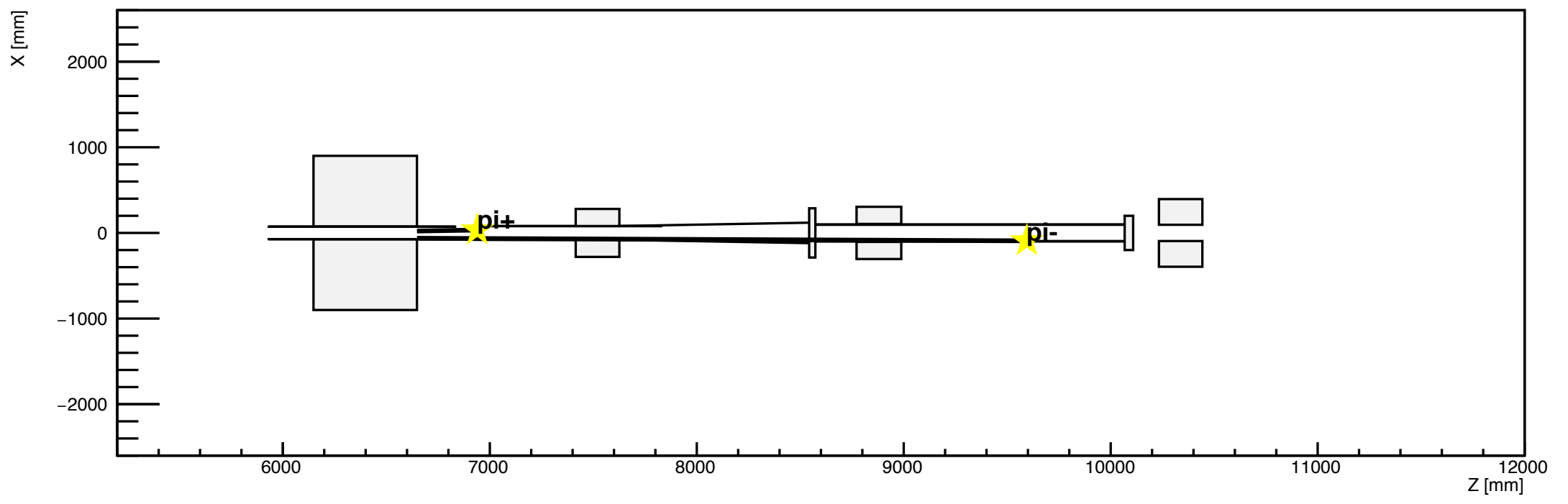

h1

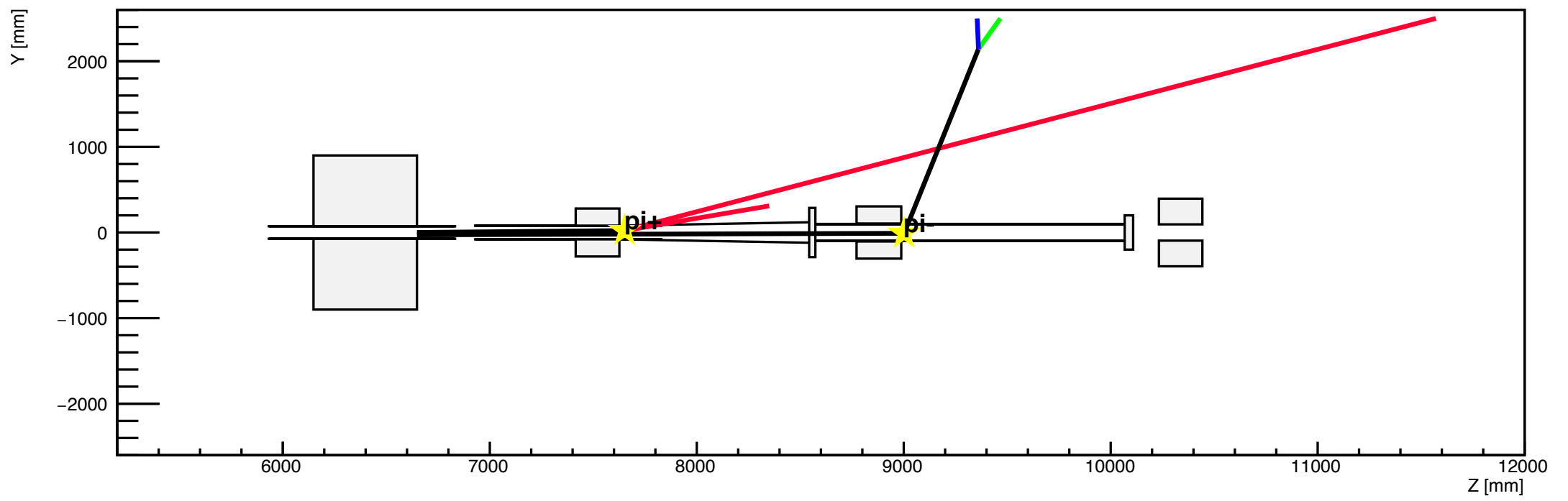

h2

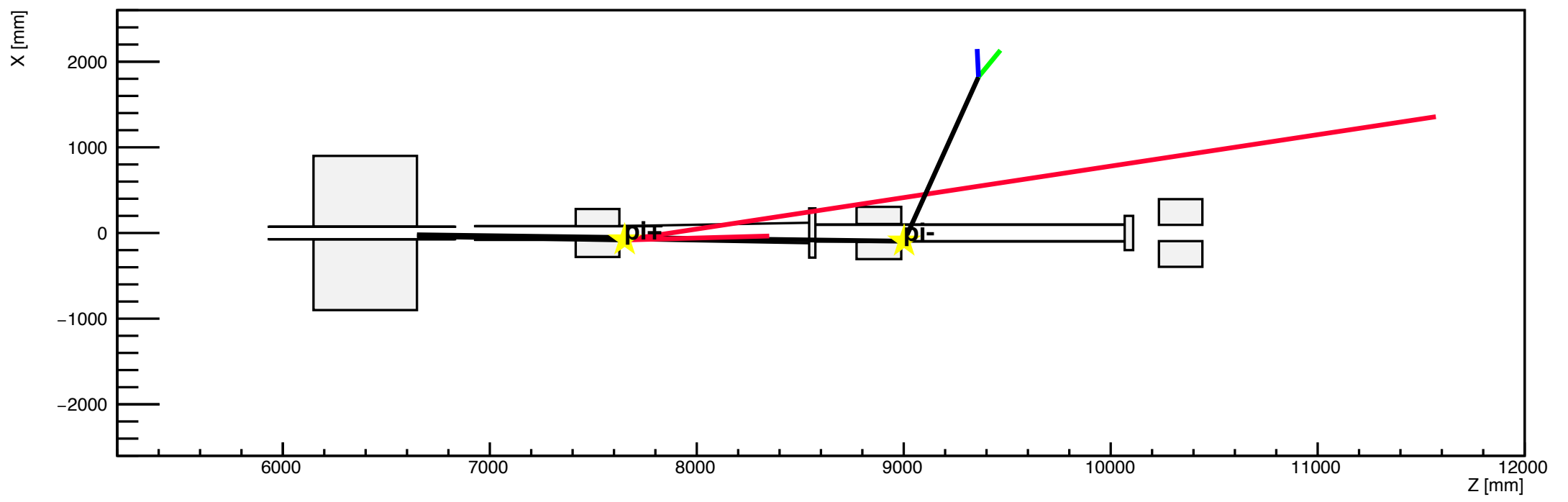

h1

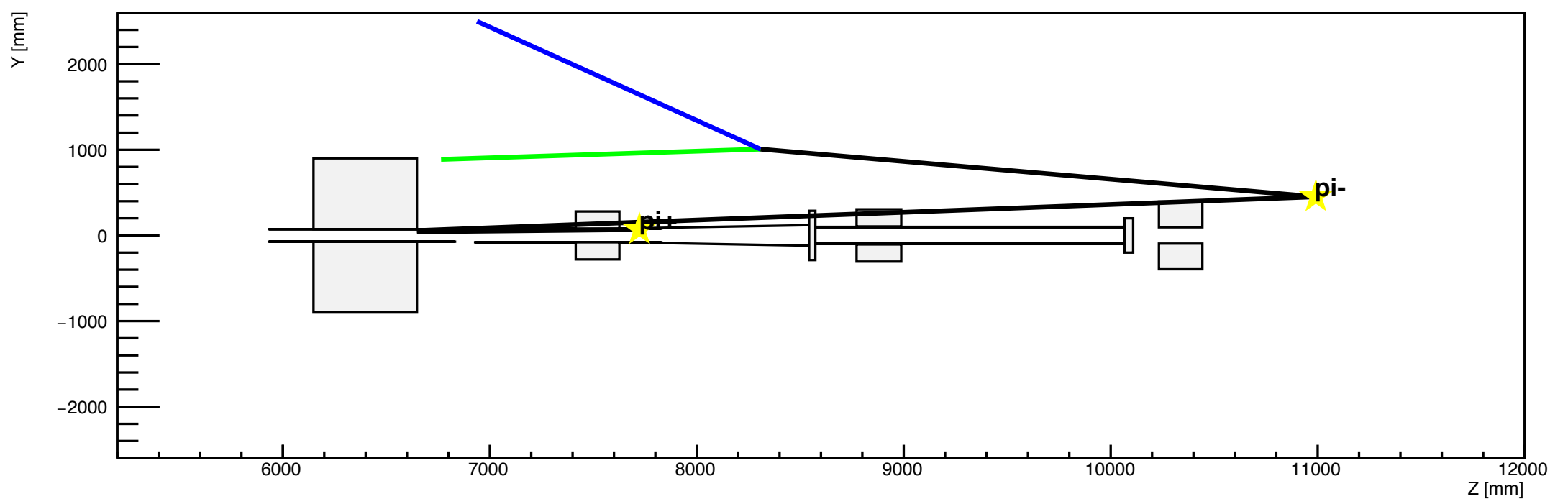

h2

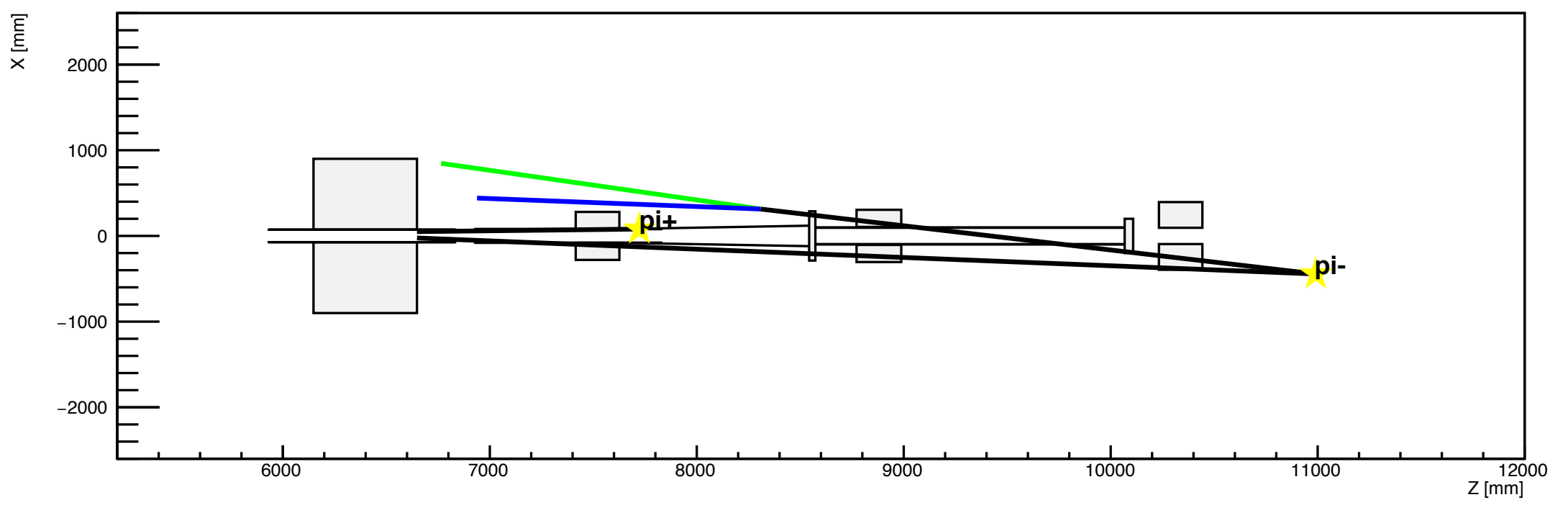

h1

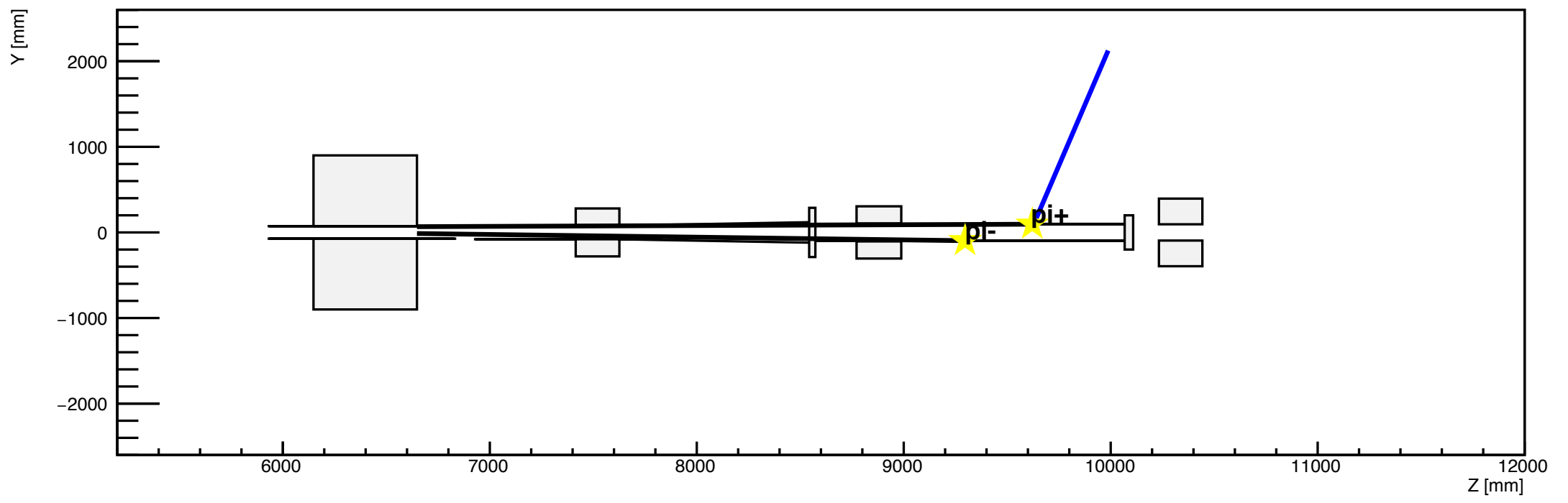

h2

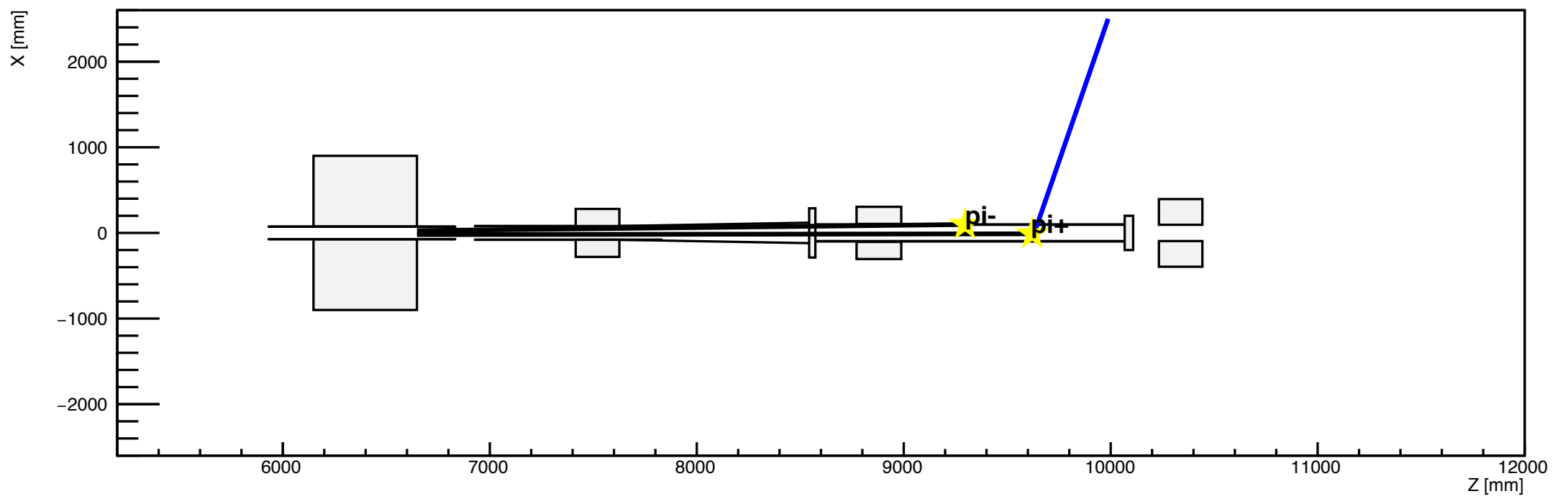

h1

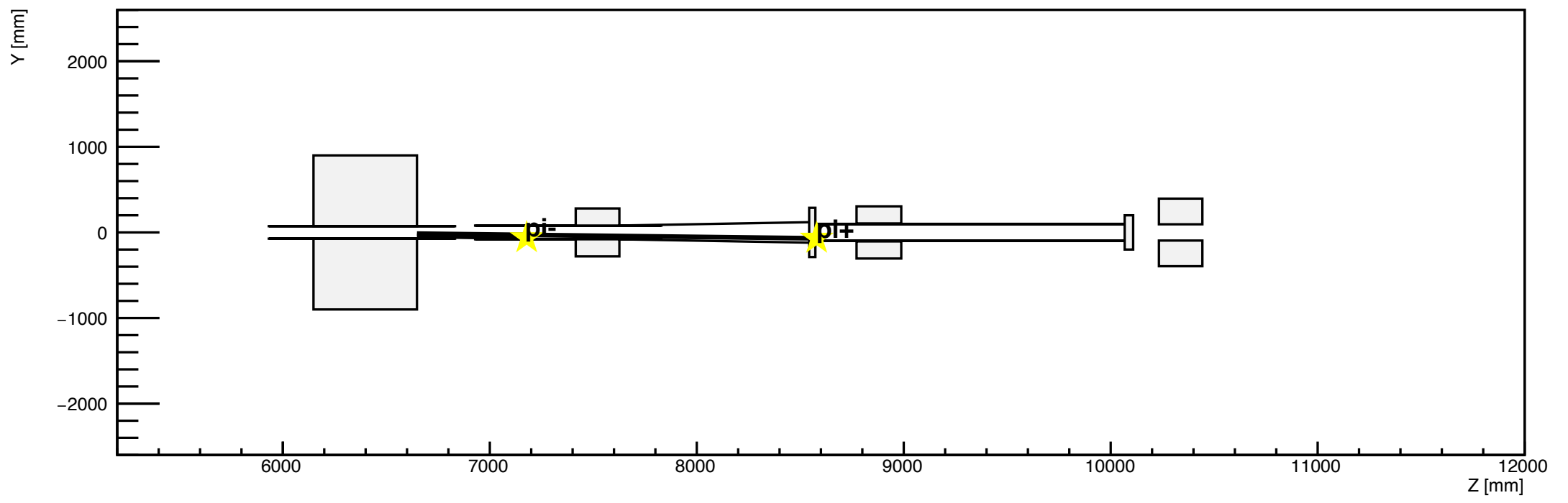

h2

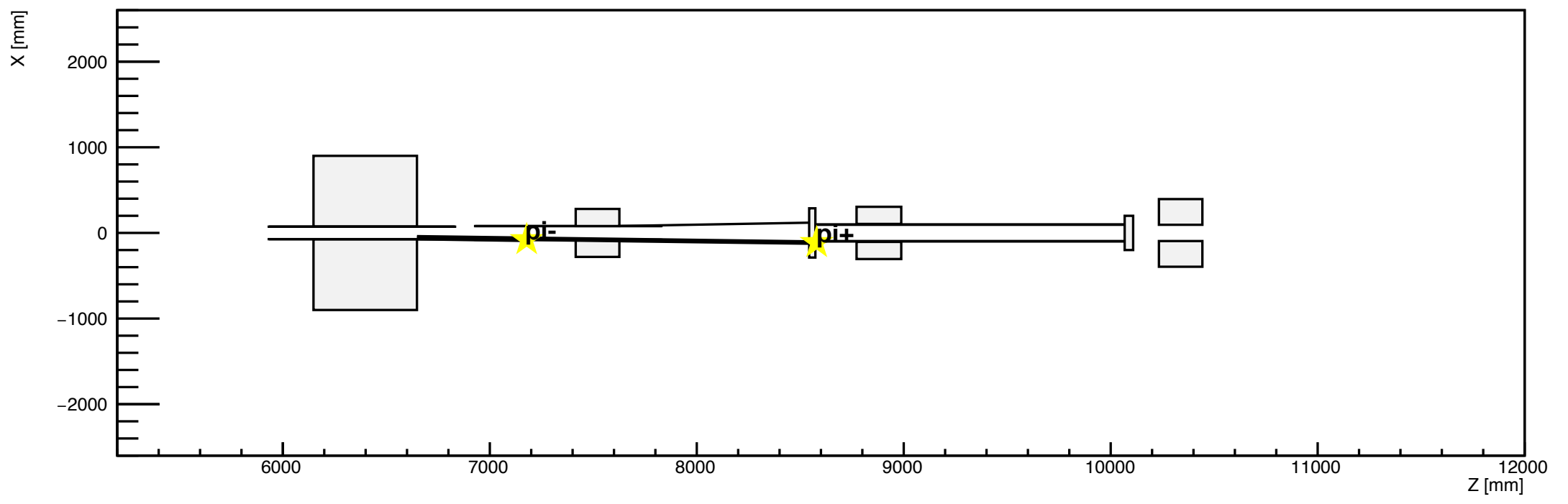

h1

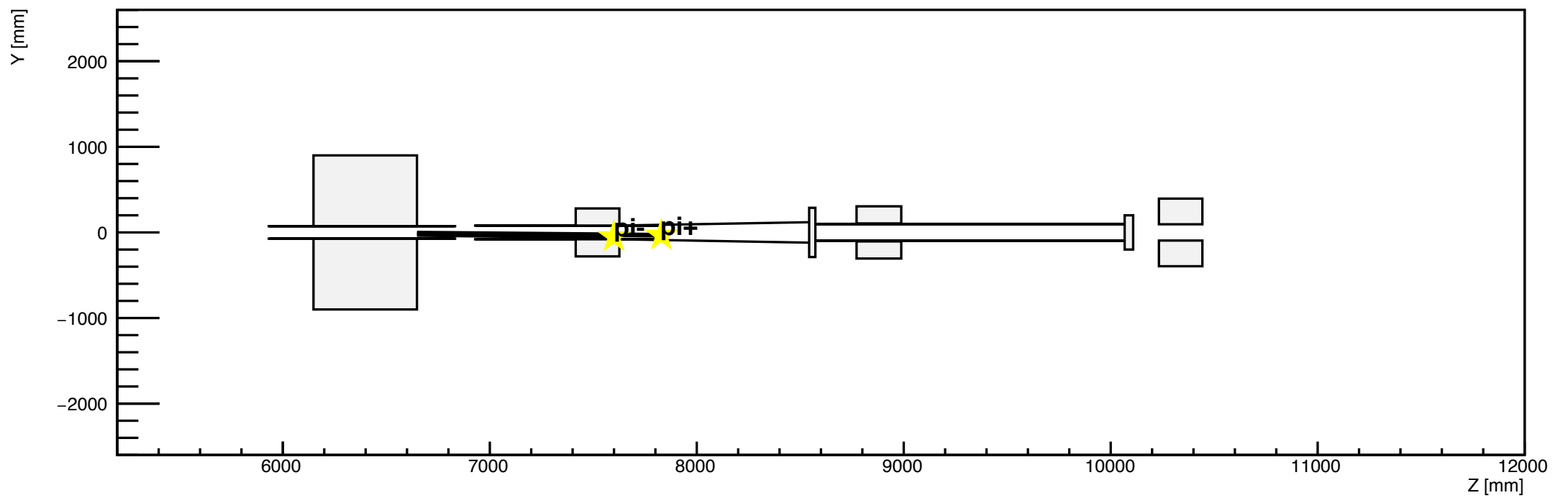

h2

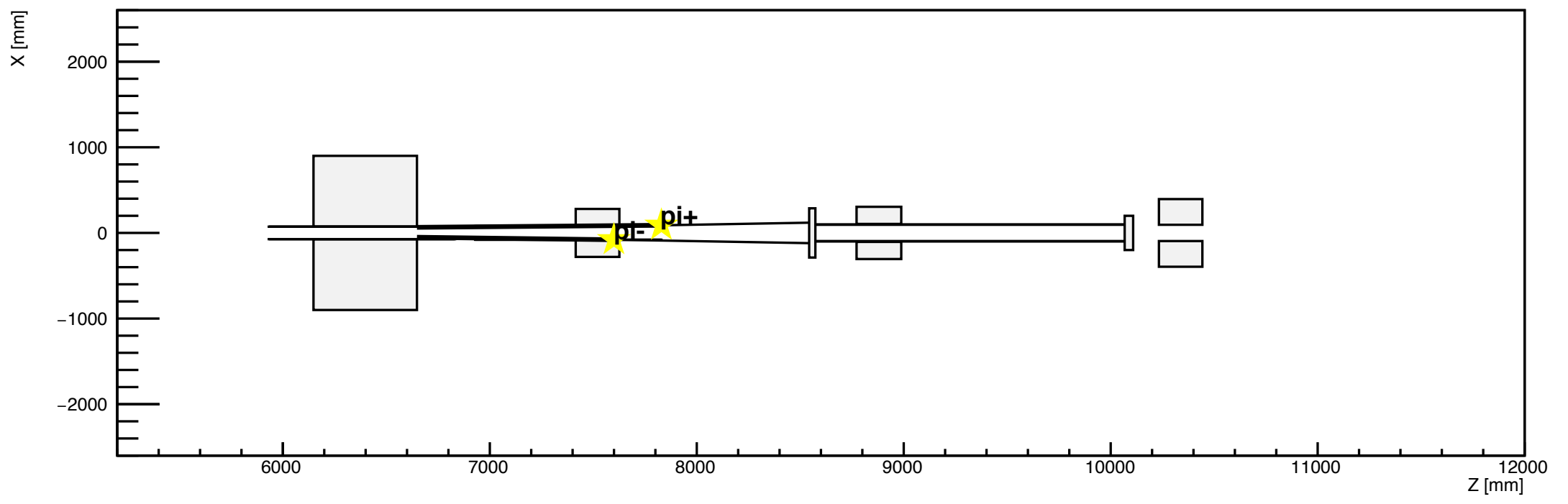

h1

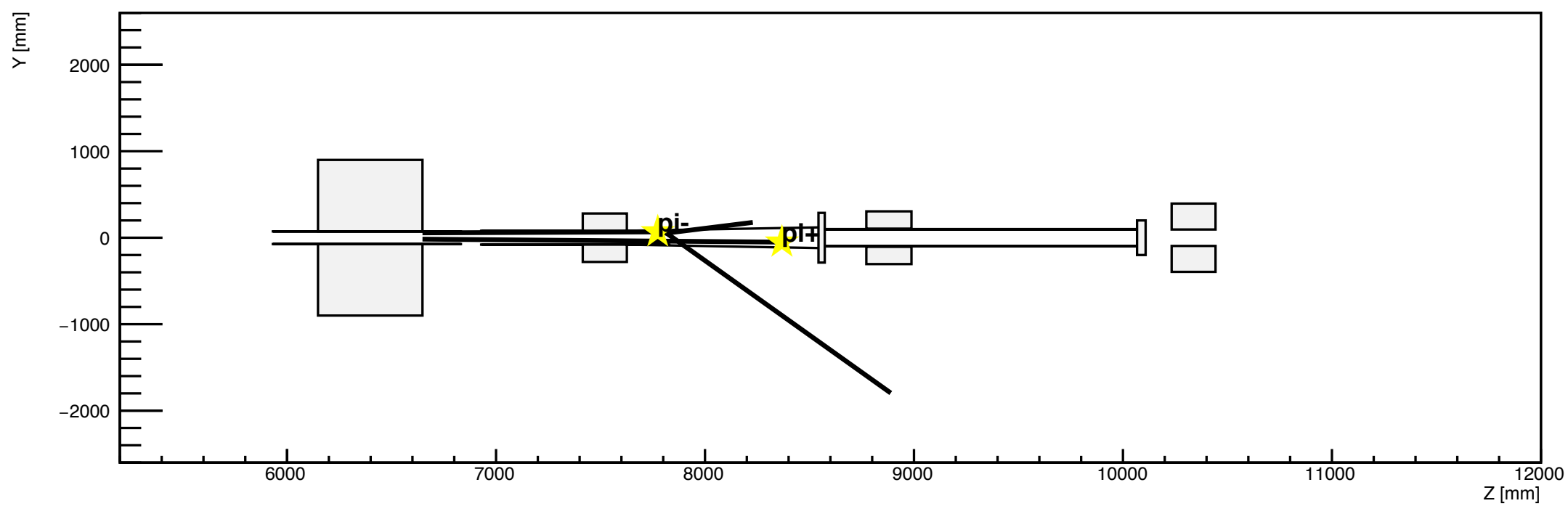

h2

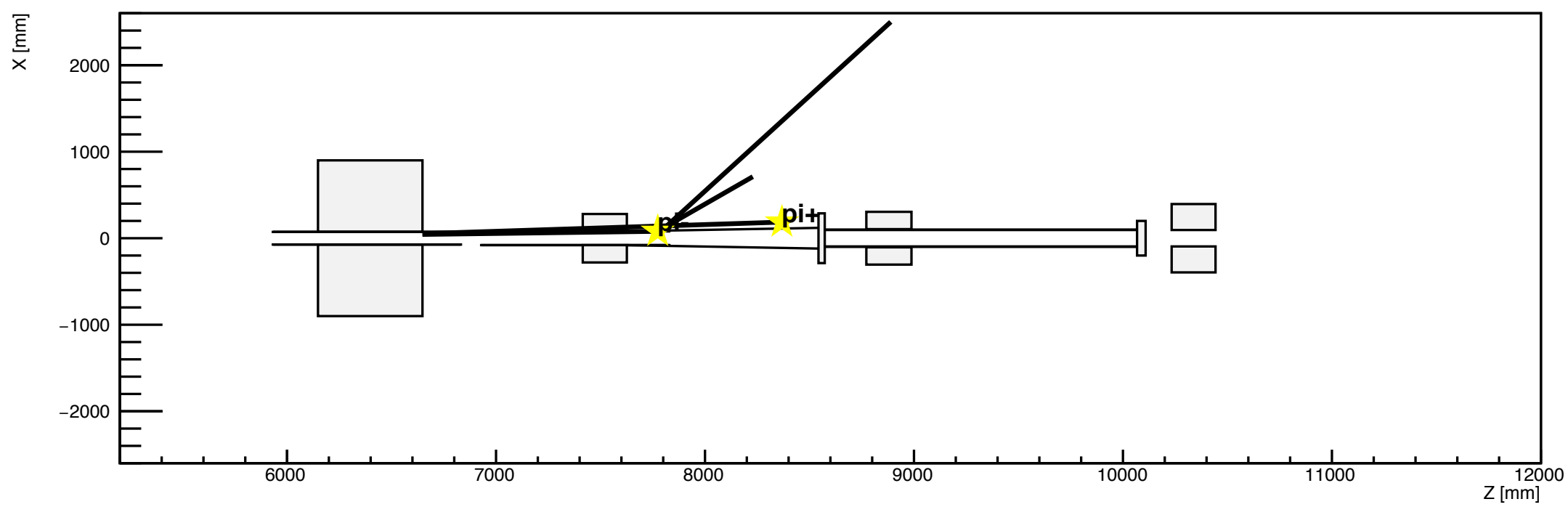

h1

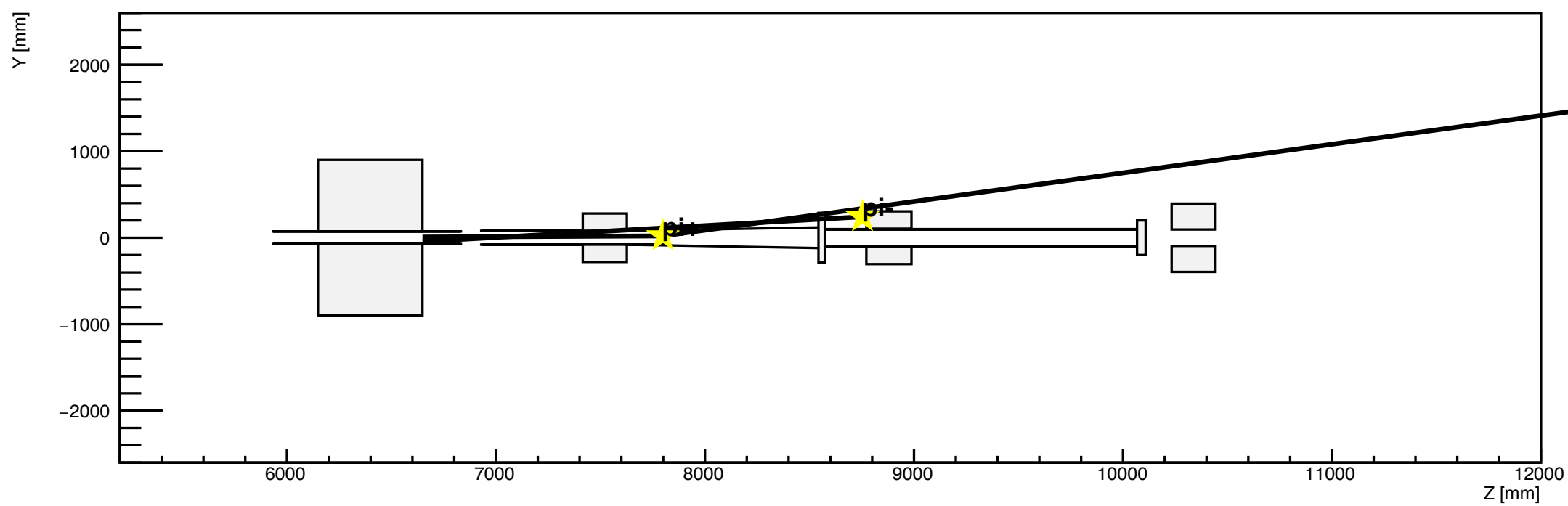

h2

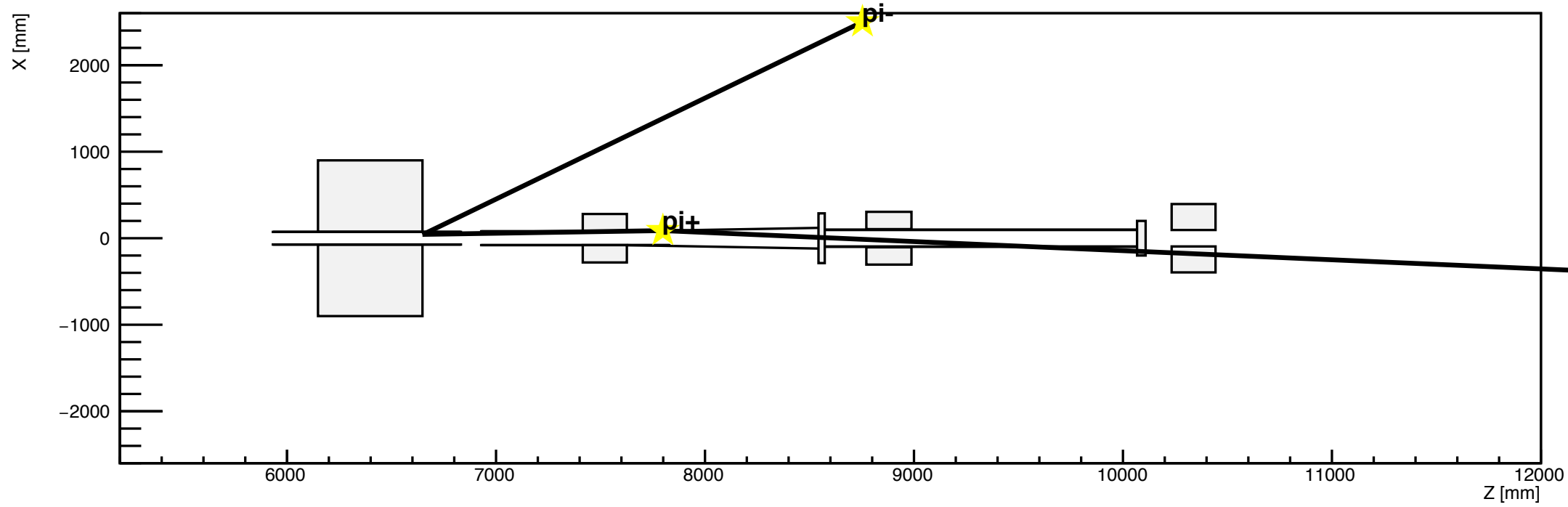

h1

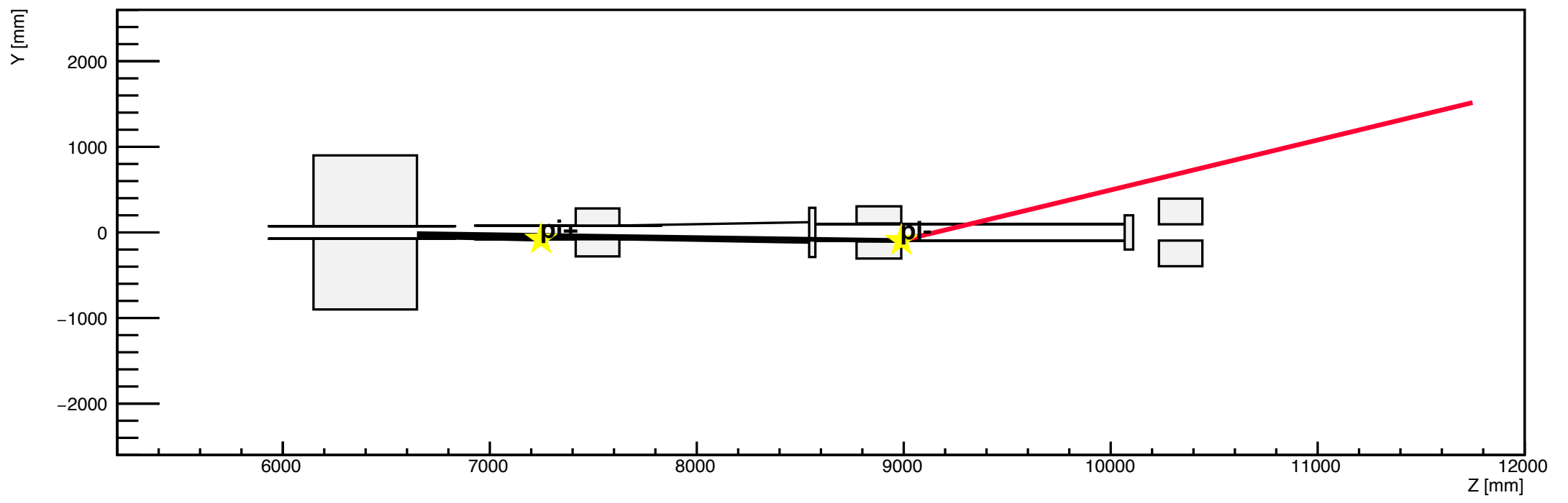

h2

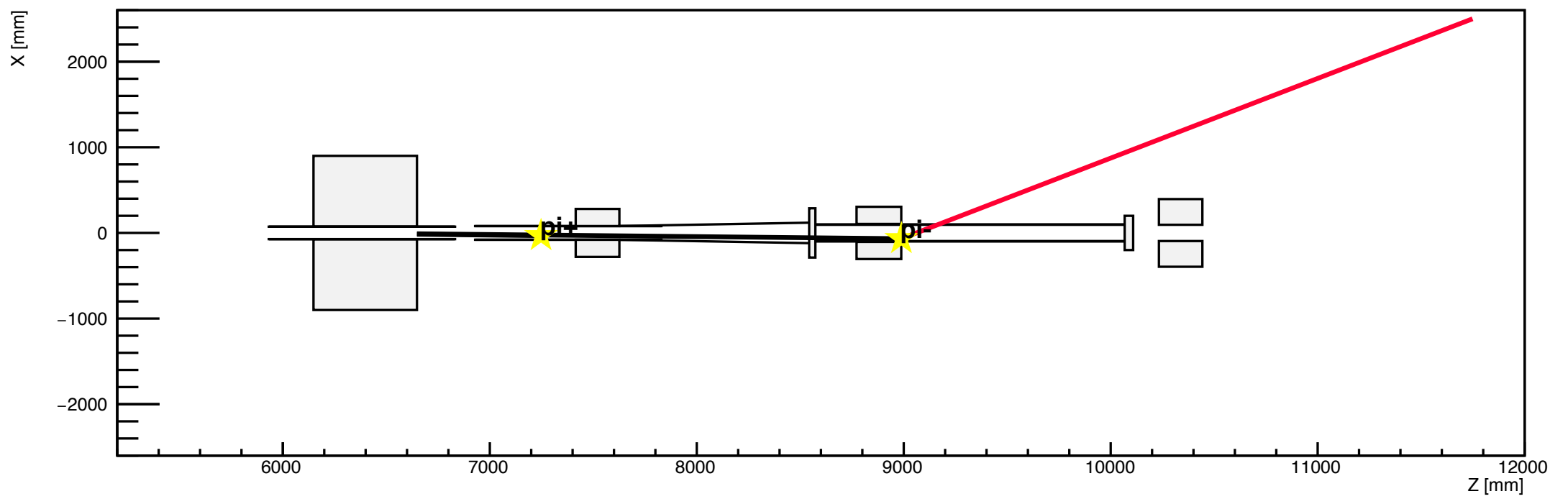

h1

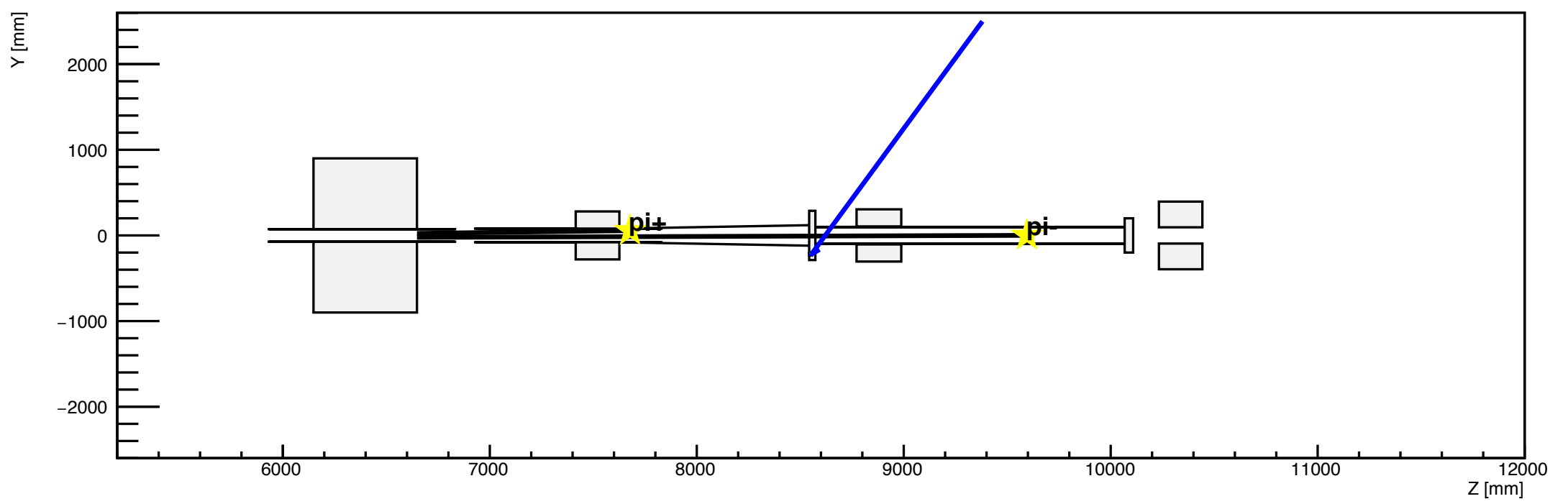

h2

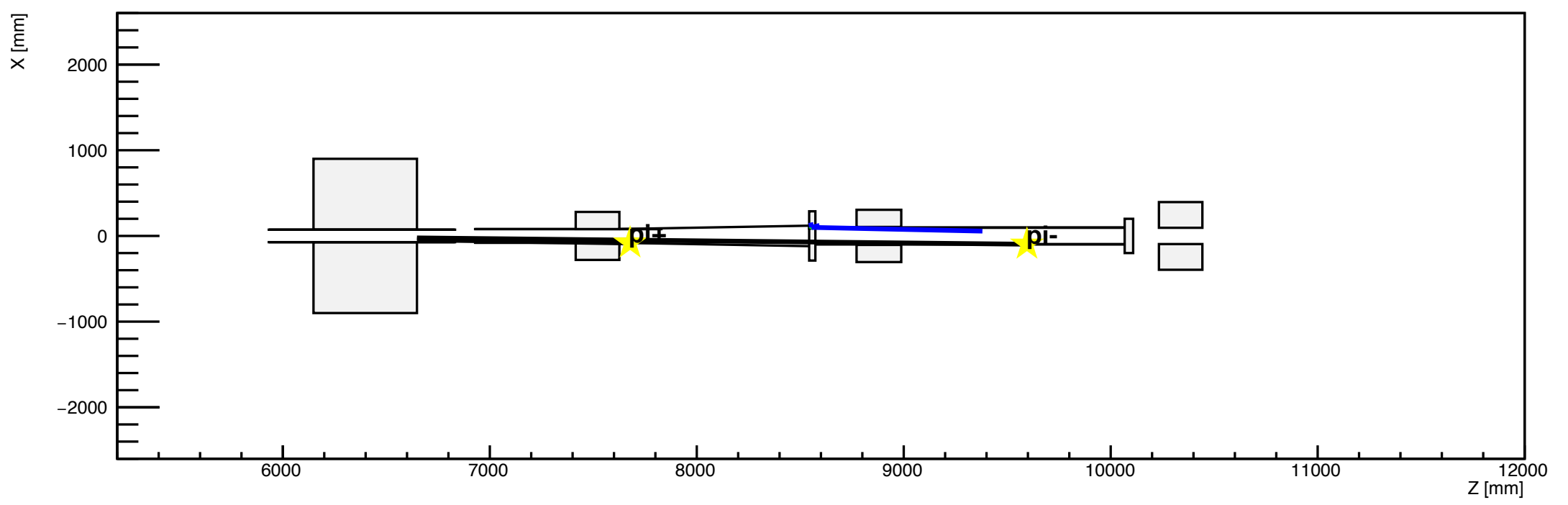

h1

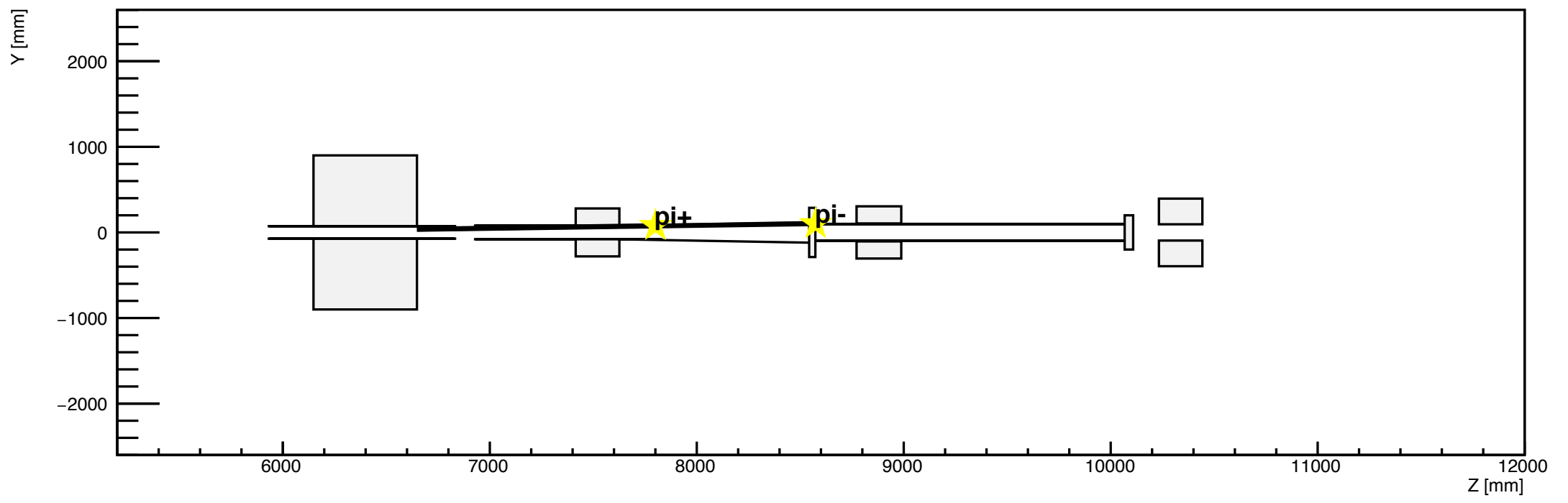

h2

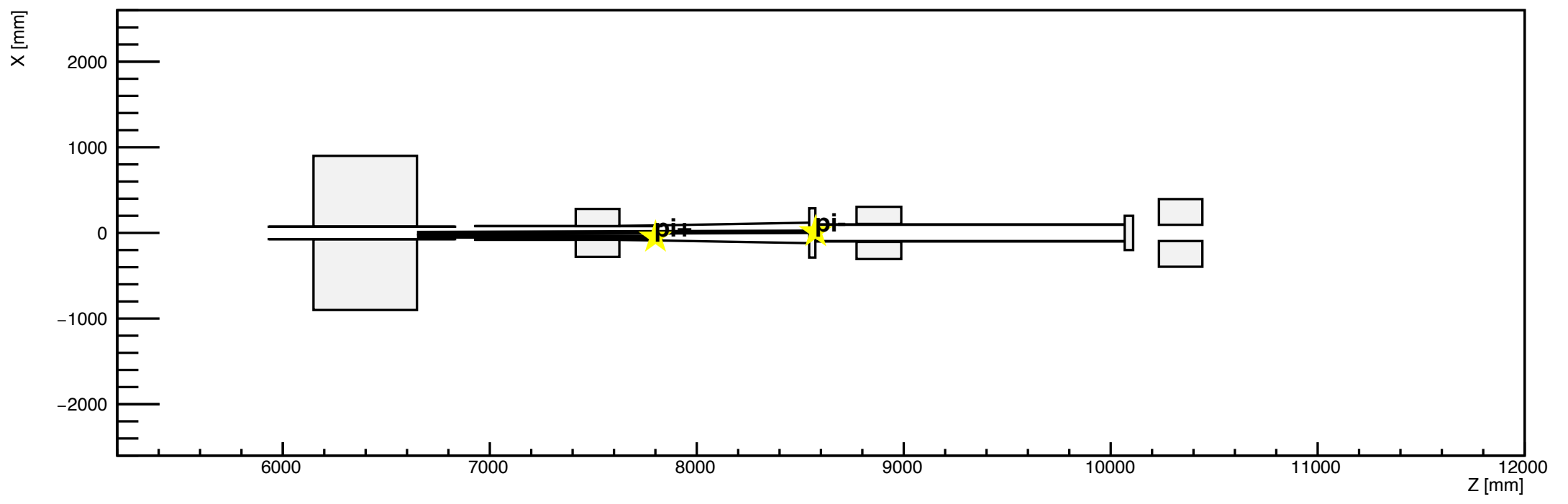

h1

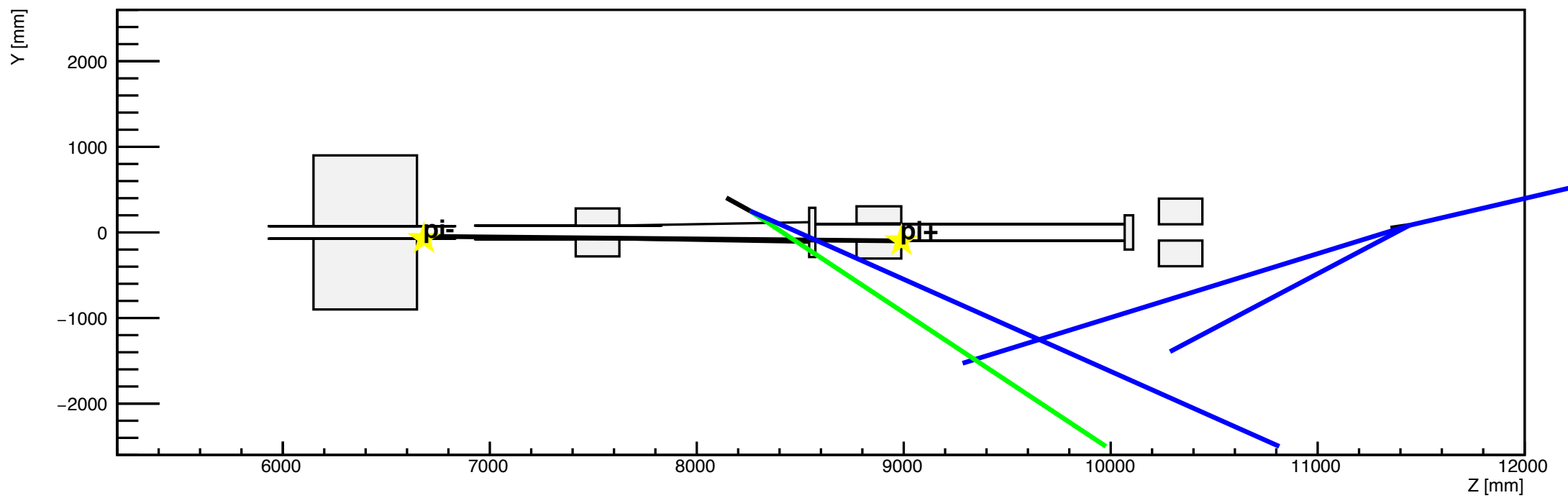

h2

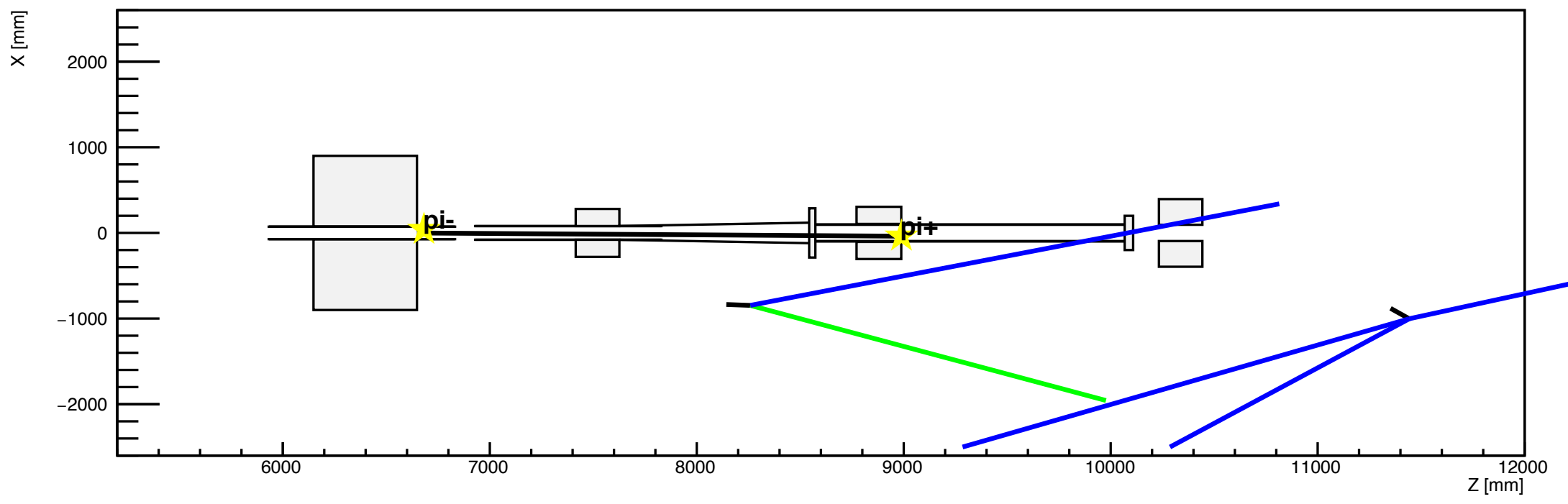

h1

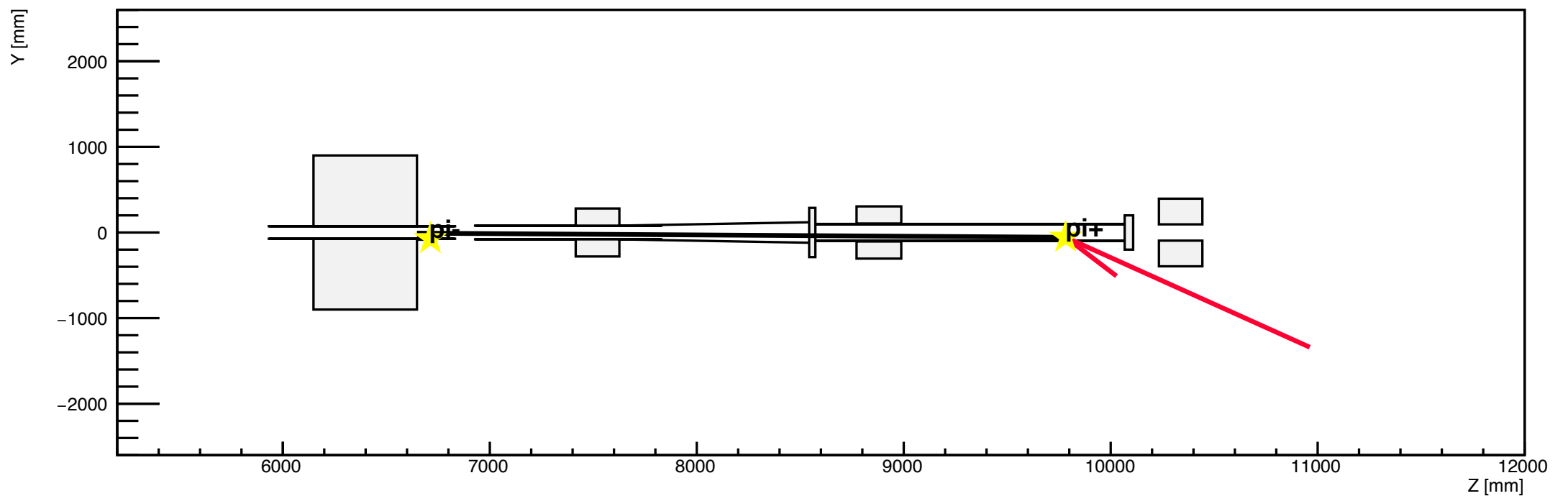

h2

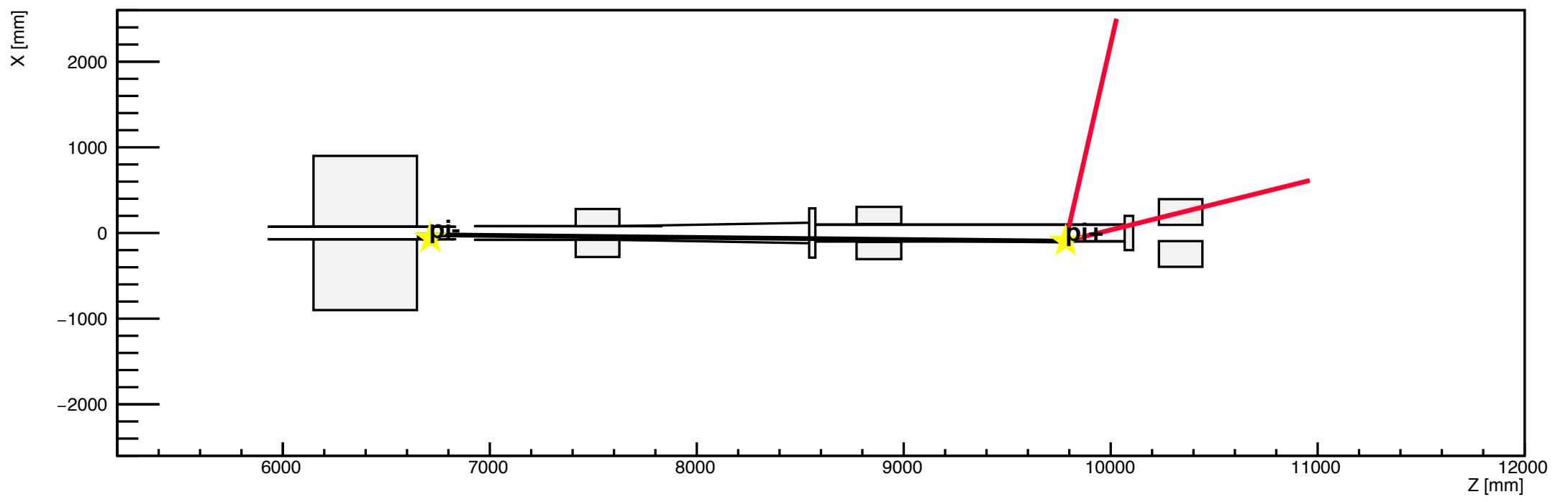

h1

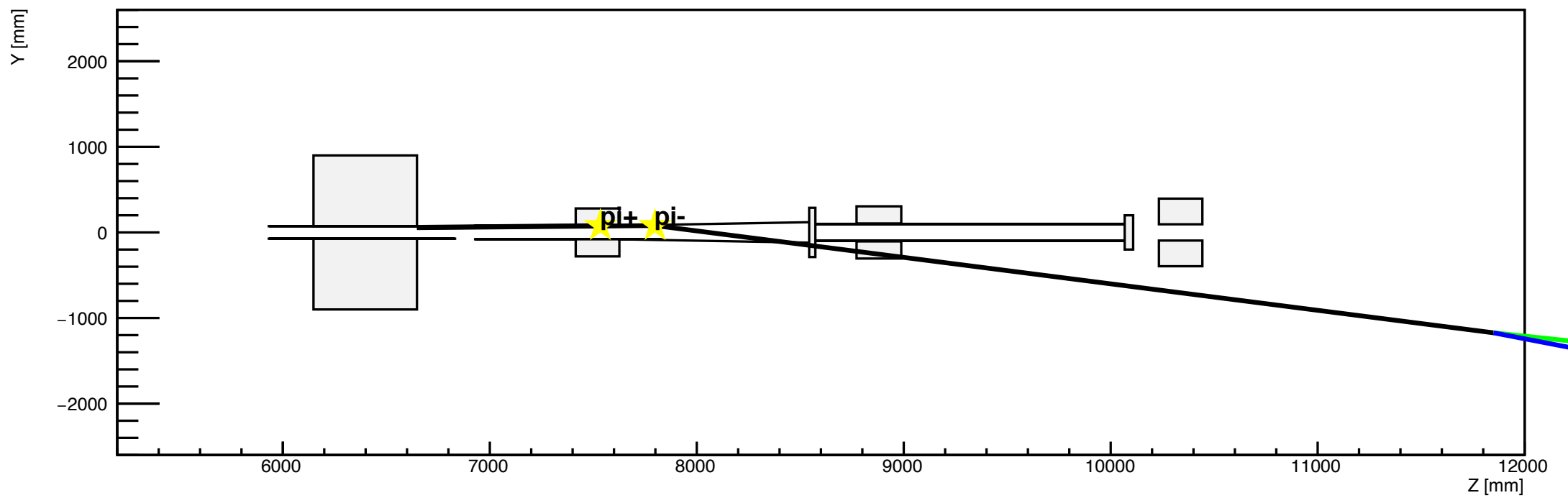

h2

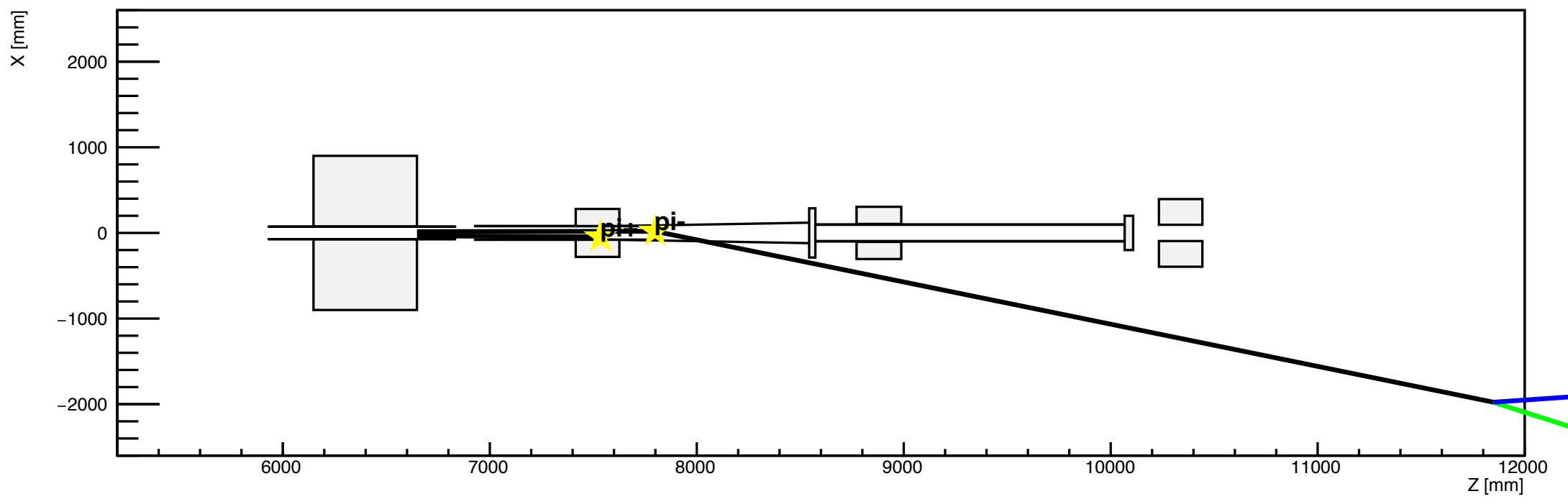

h1

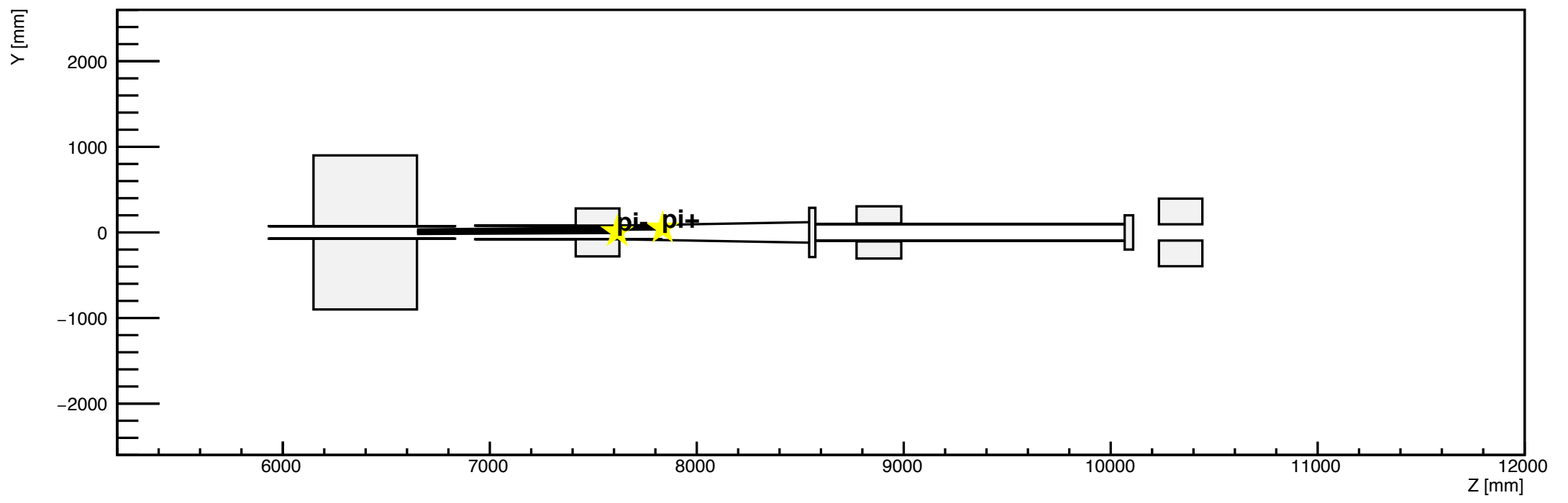

h2

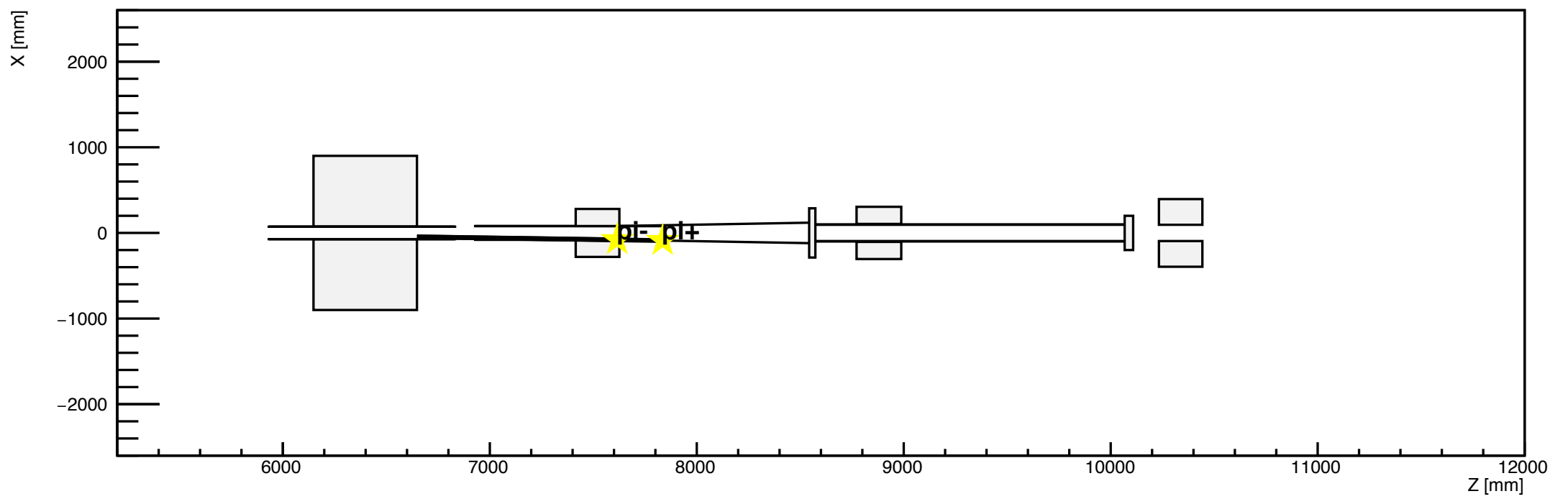

h1

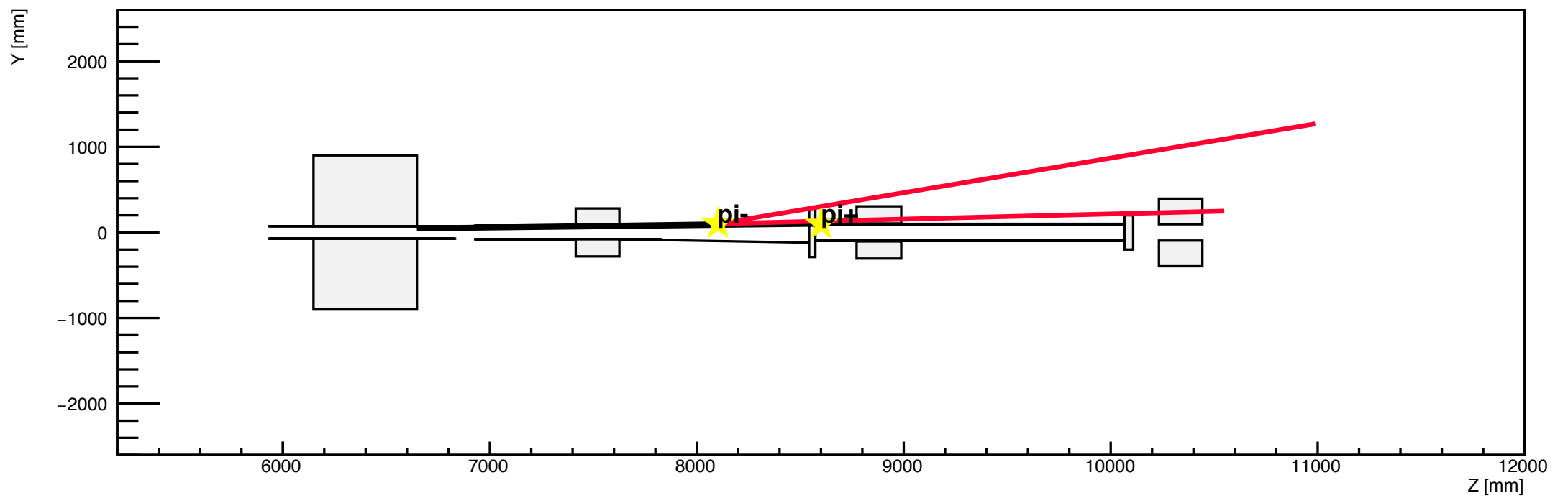

h2

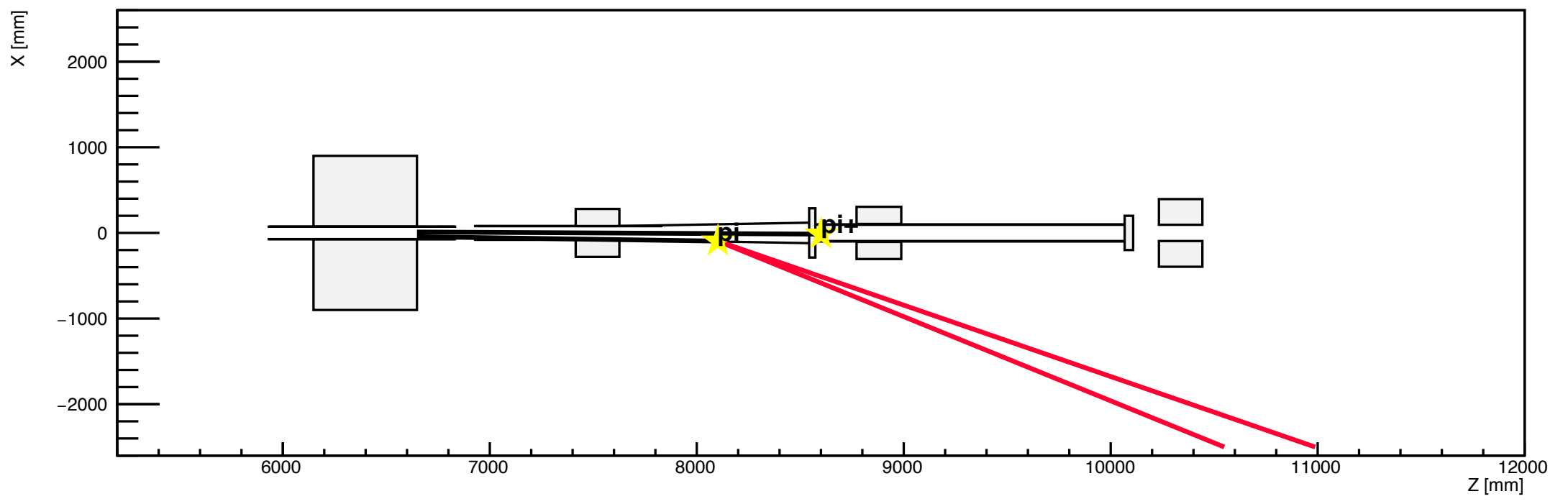

h1

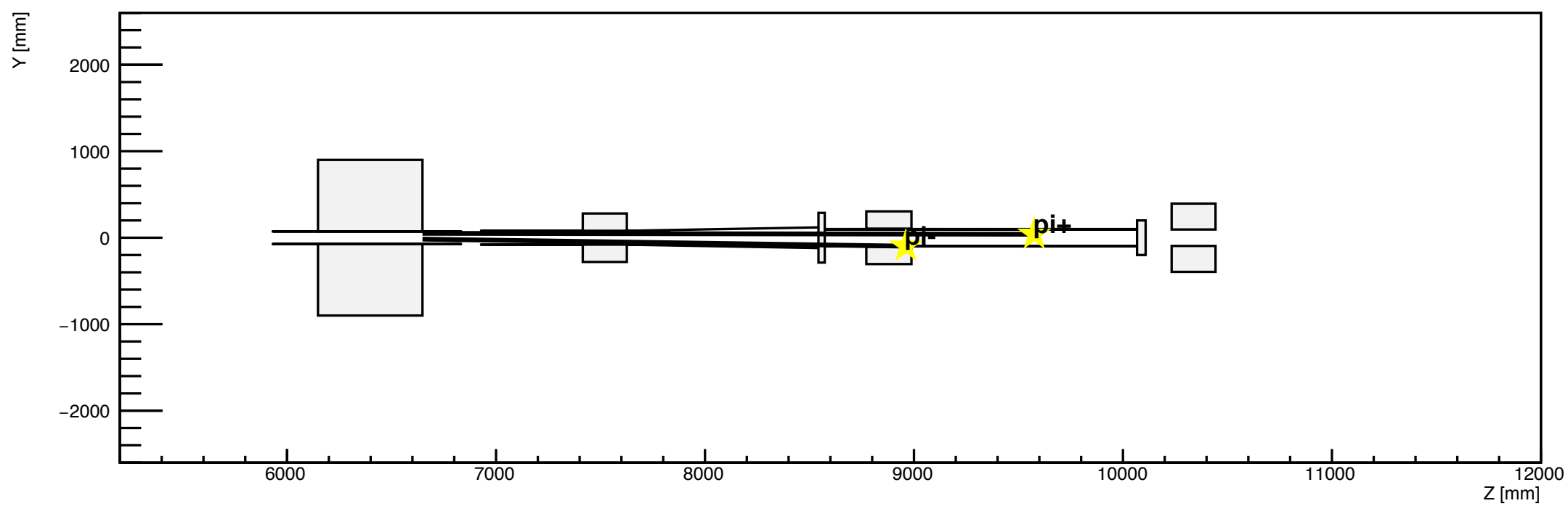

h2

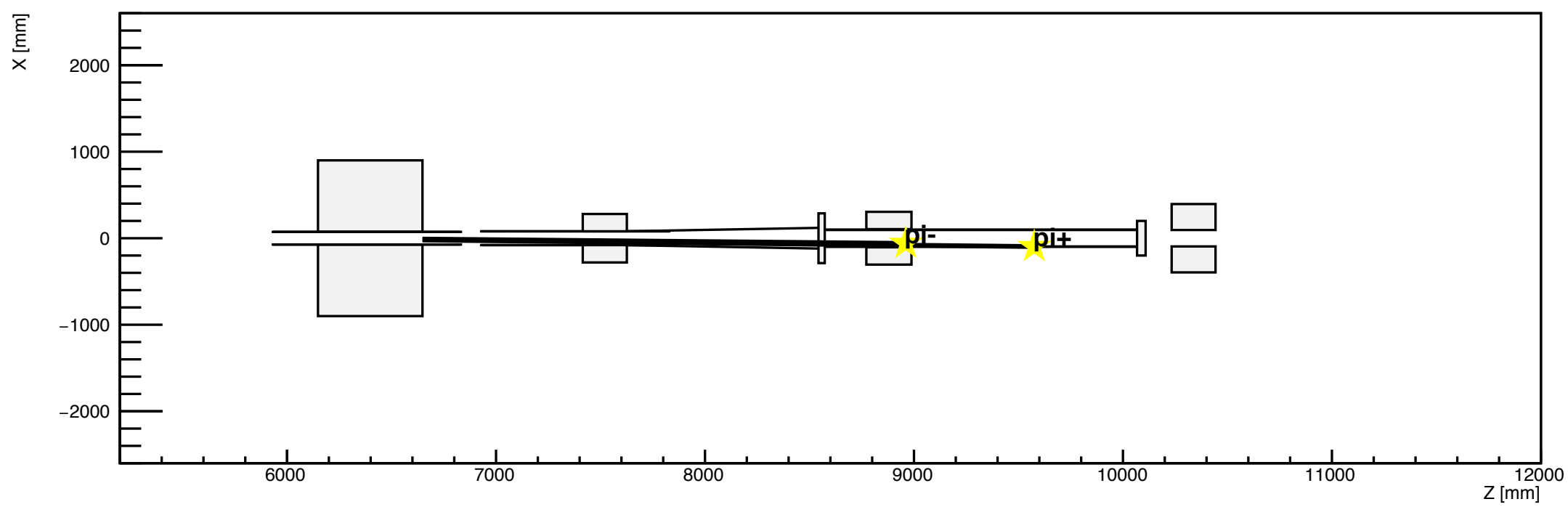

h1

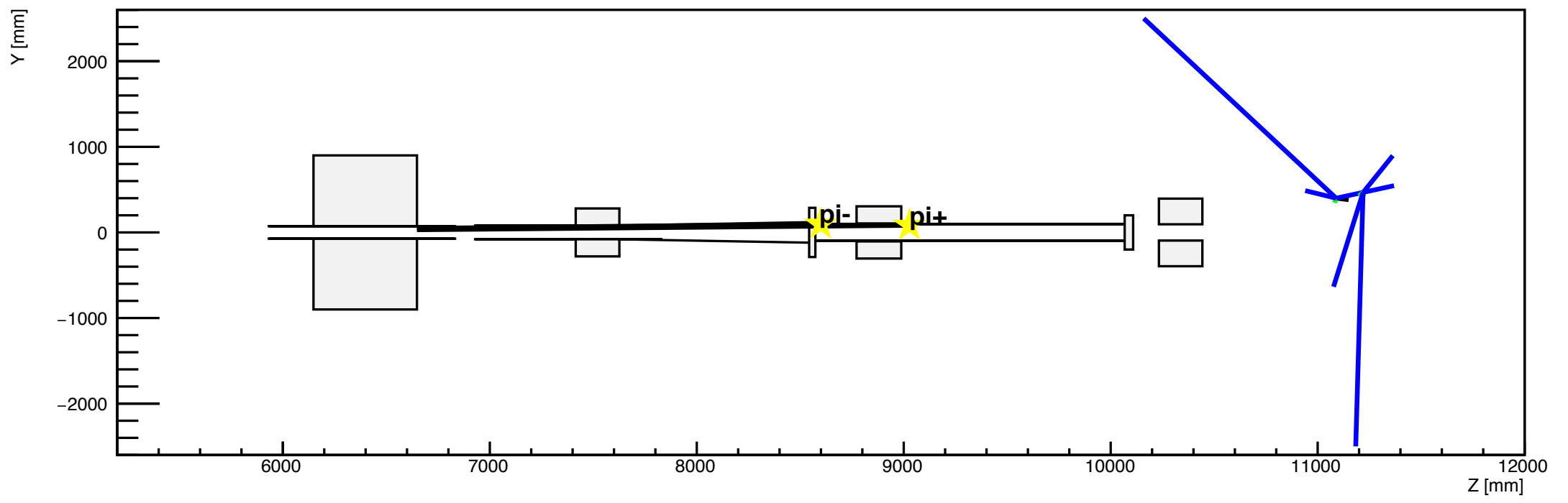

h2

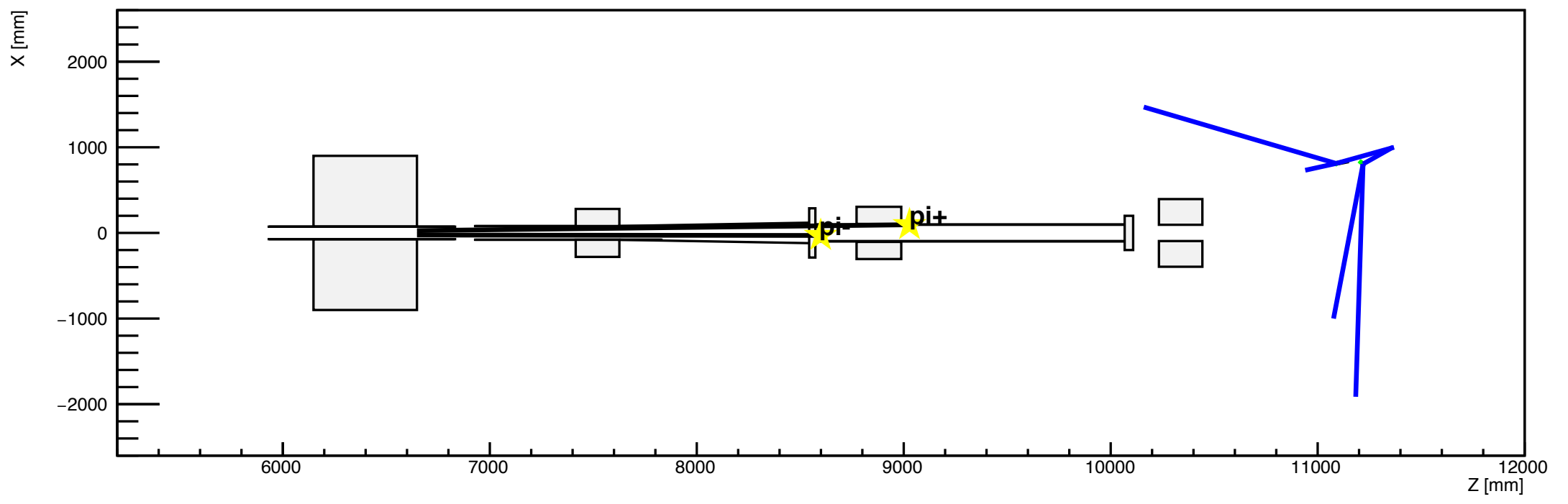

h1

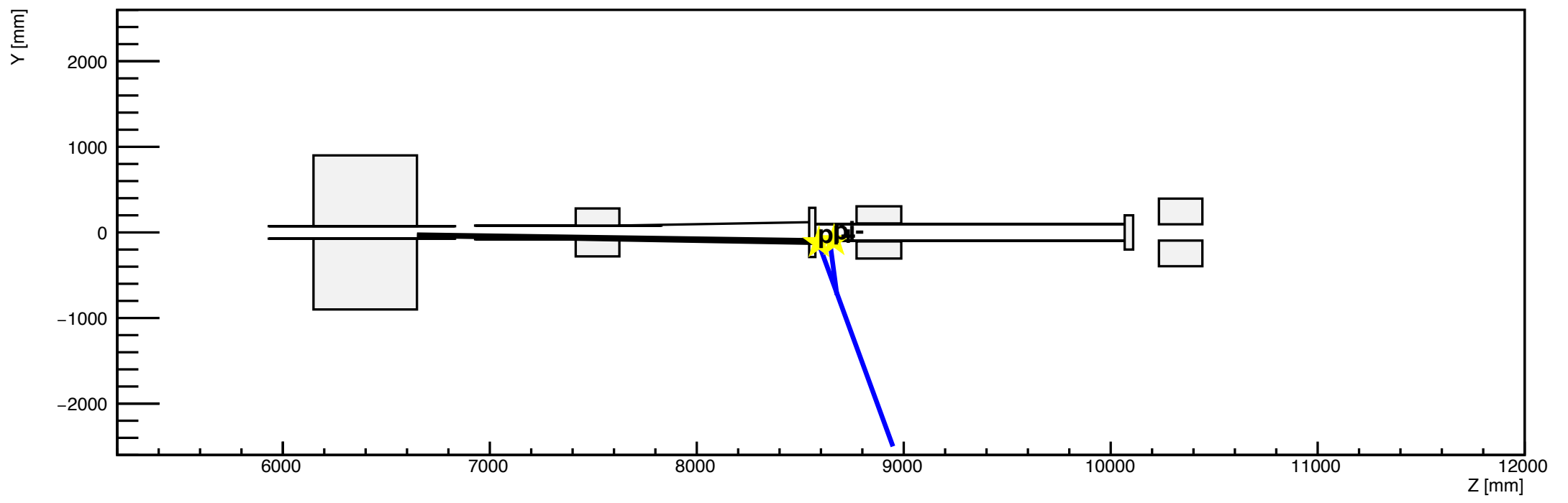

h2

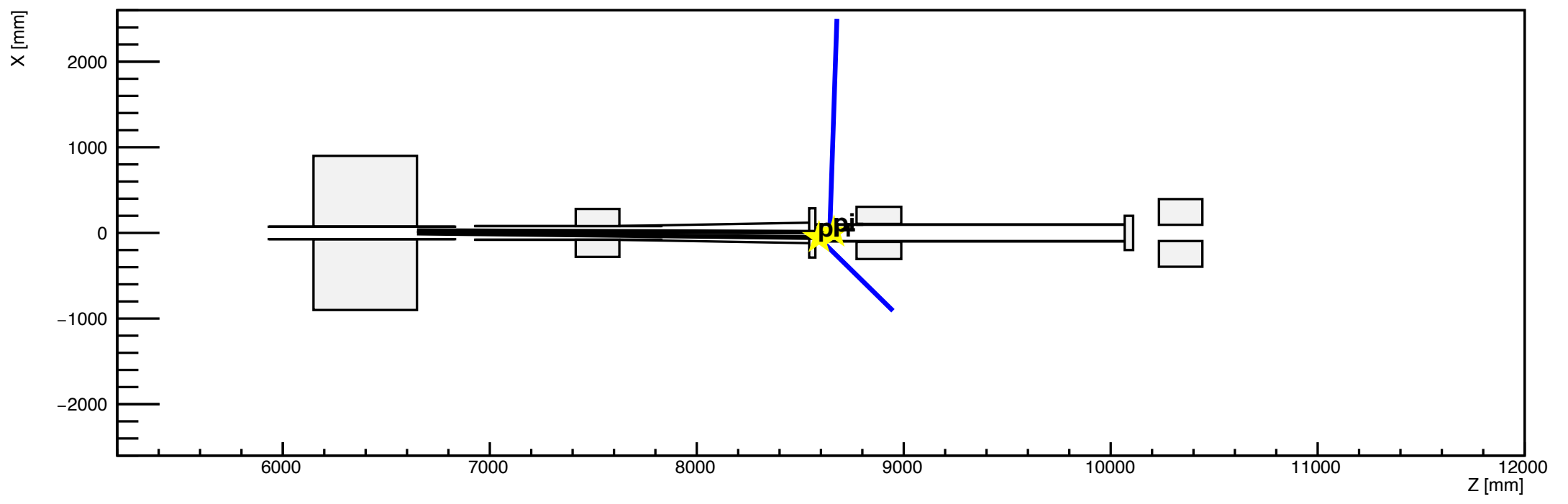

h1

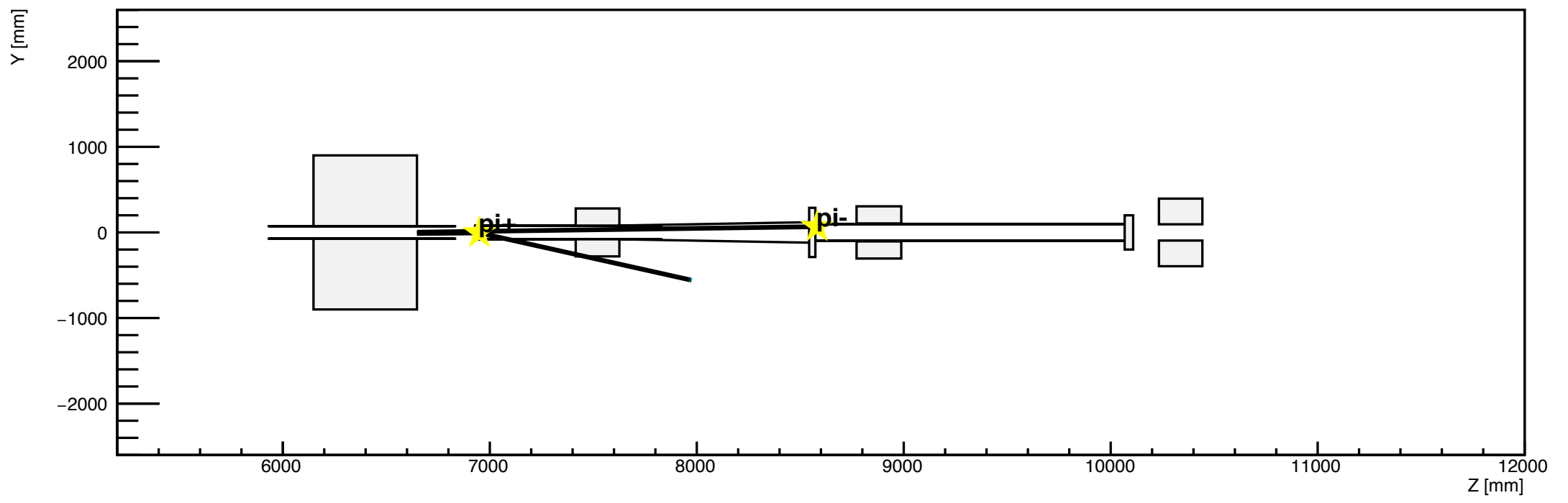

h2

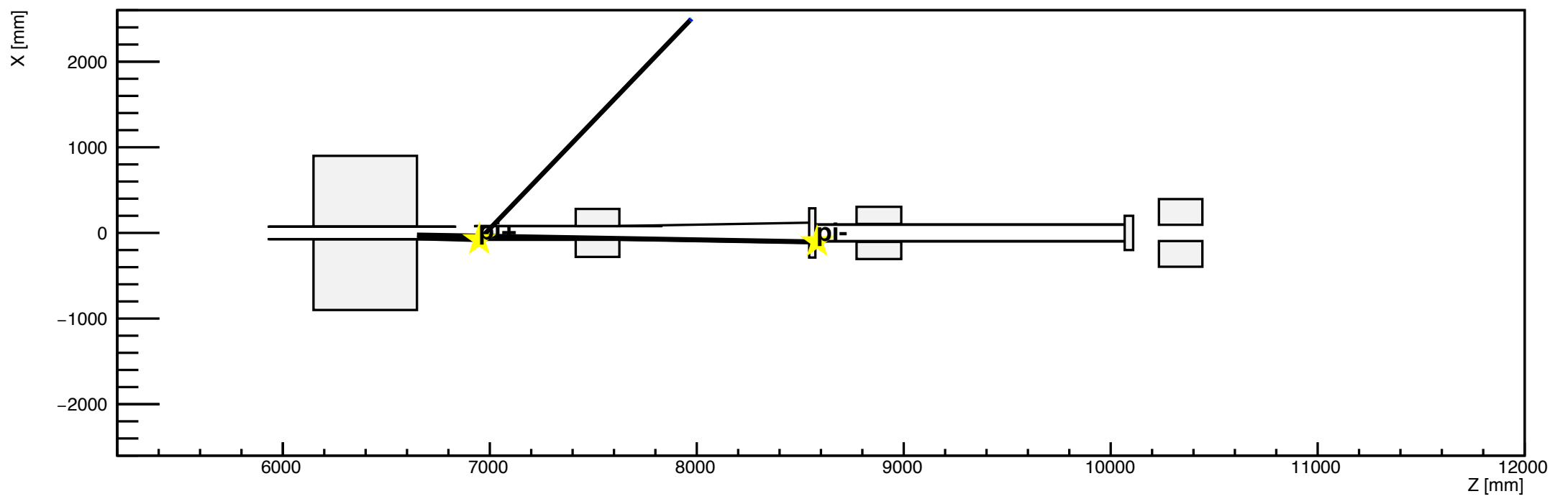

h1

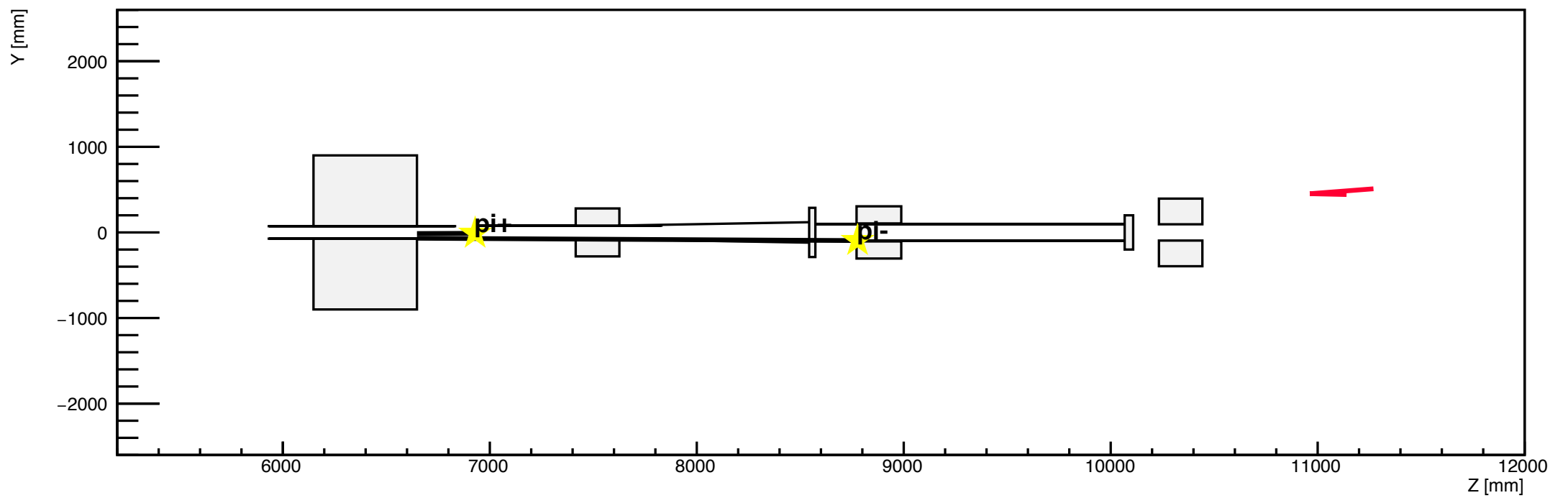

h2

