

# Development of a MPPC signal amplifier circuit

2016/2/19

Wooseung Jung

# E42 hypTPC

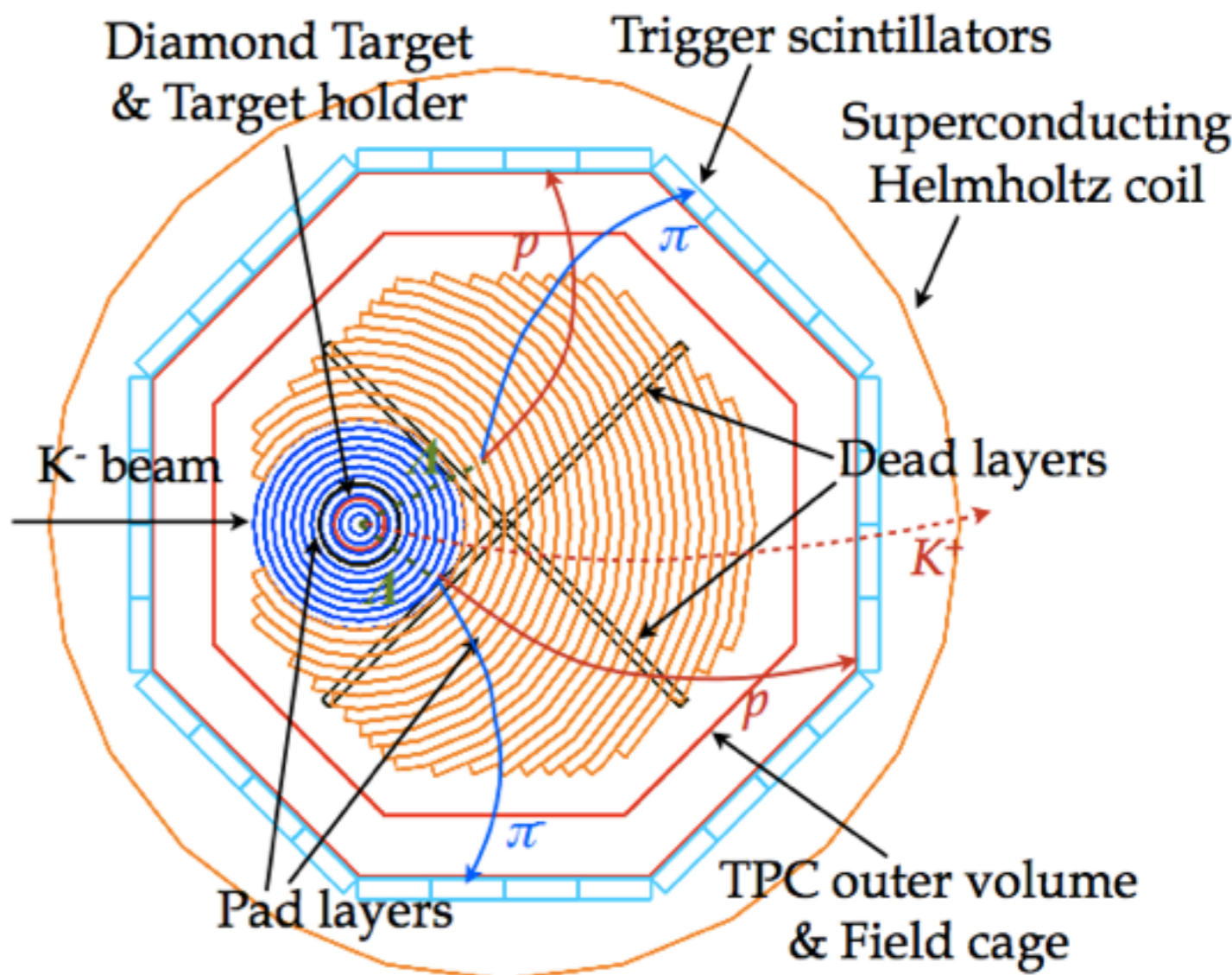
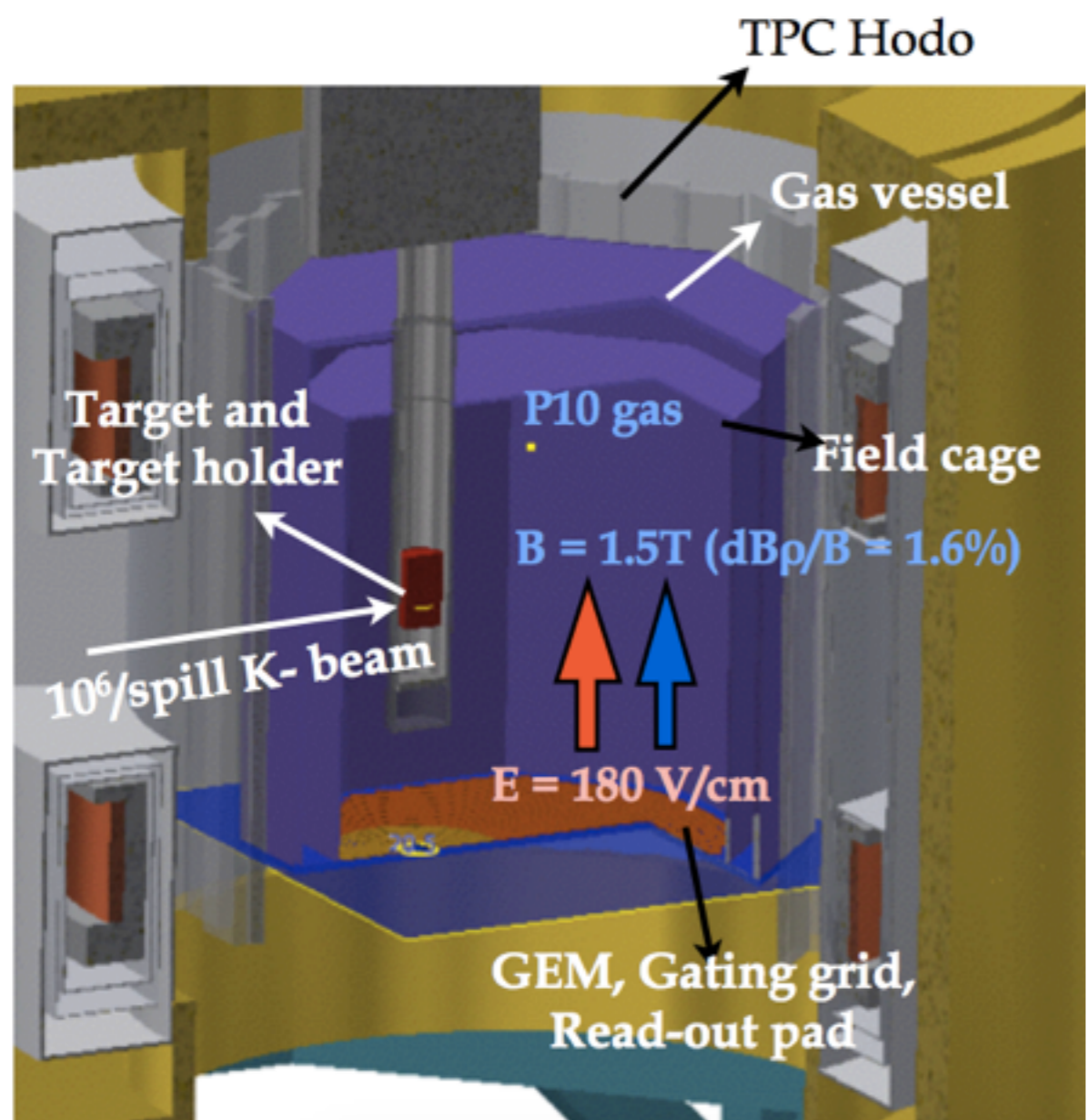

# MPPC?

## MPPC

- multi-pixel photon counter
- photodiode pixels

## Photodiode

- photoelectric effect

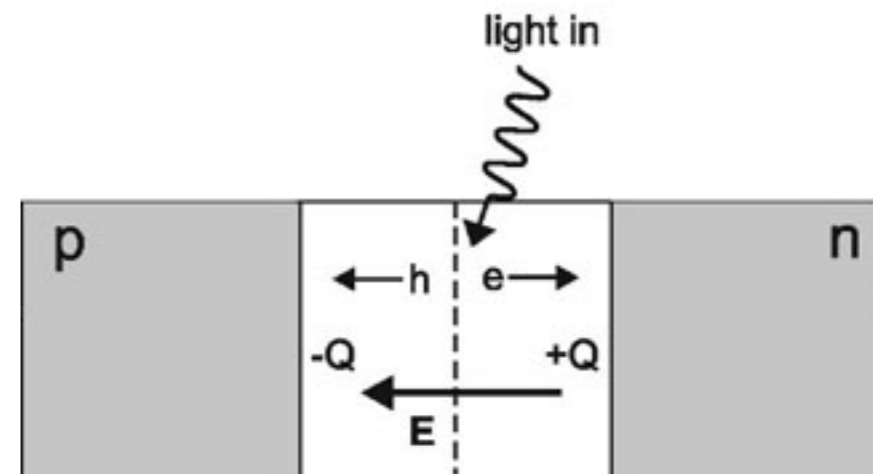
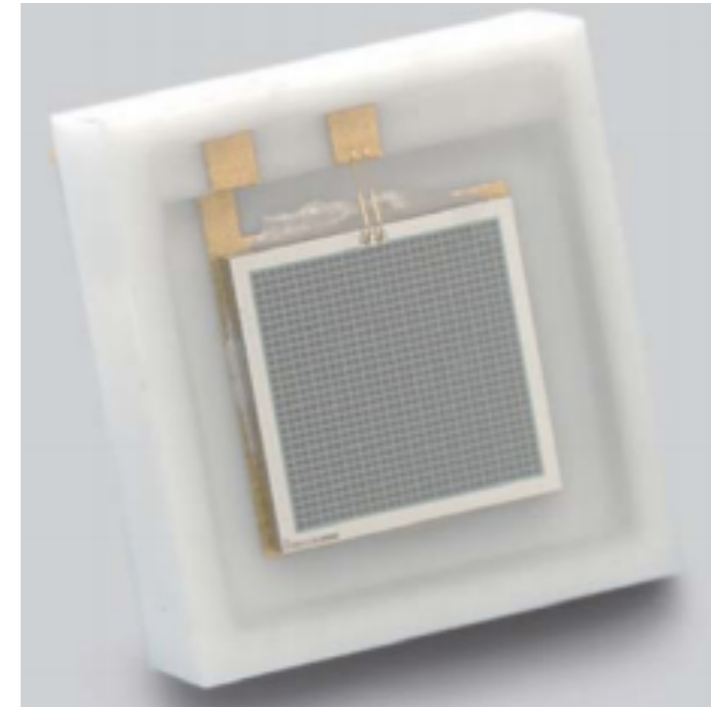

# Circuit Design

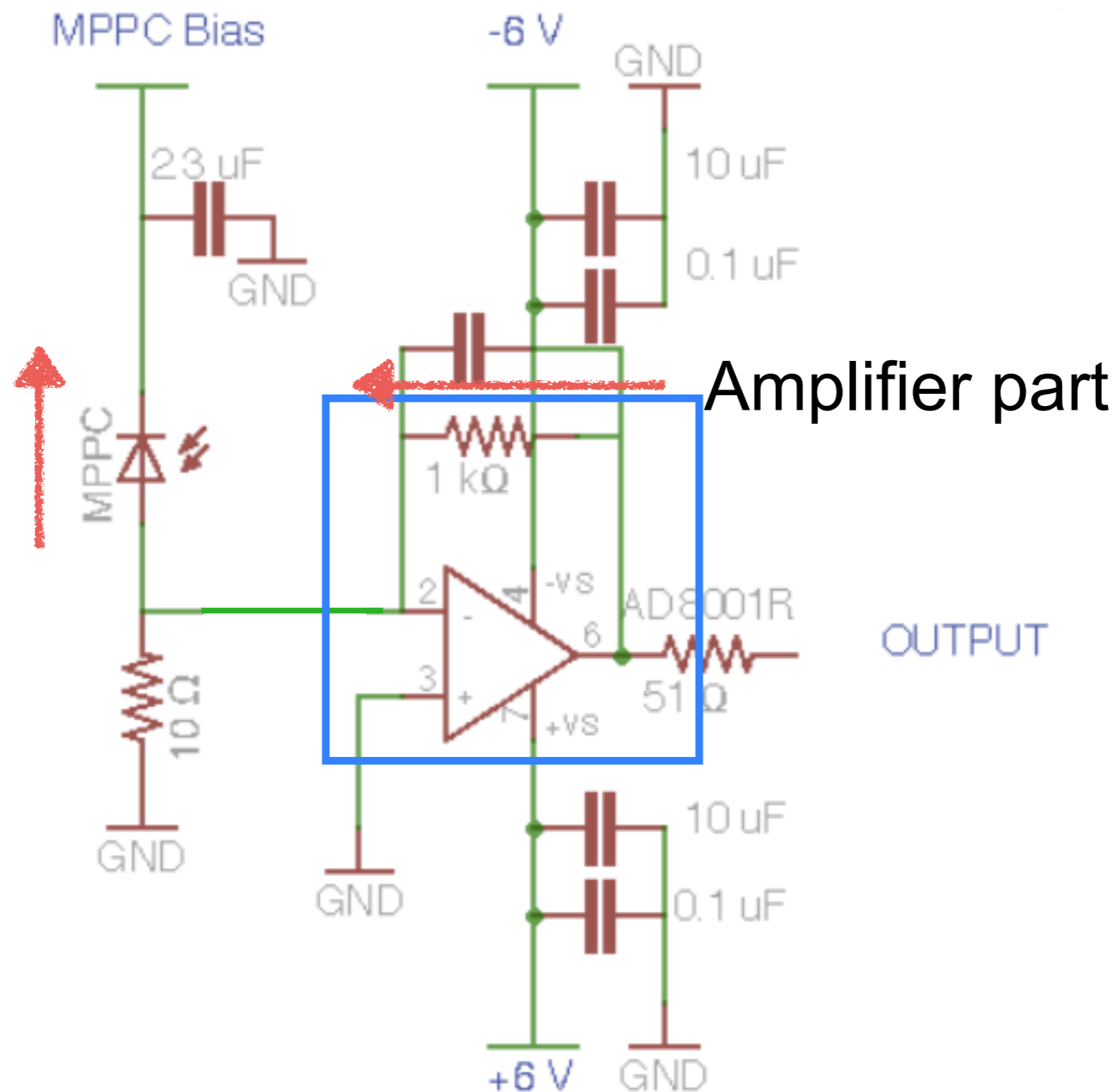



# LED test

LED

- 400nm LED source with function generator

Trigger

- 1 kHz function generator TTL

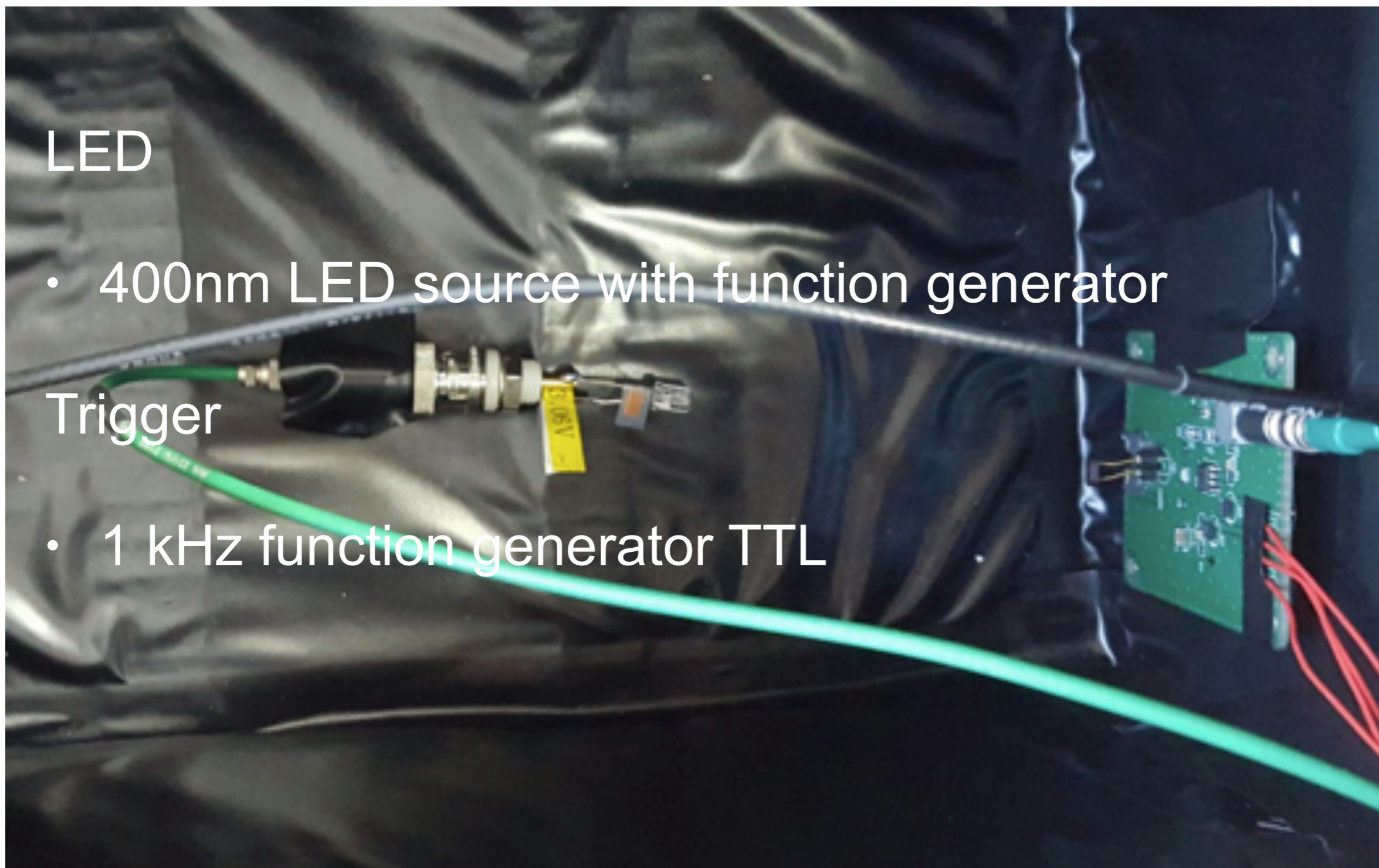

# Results

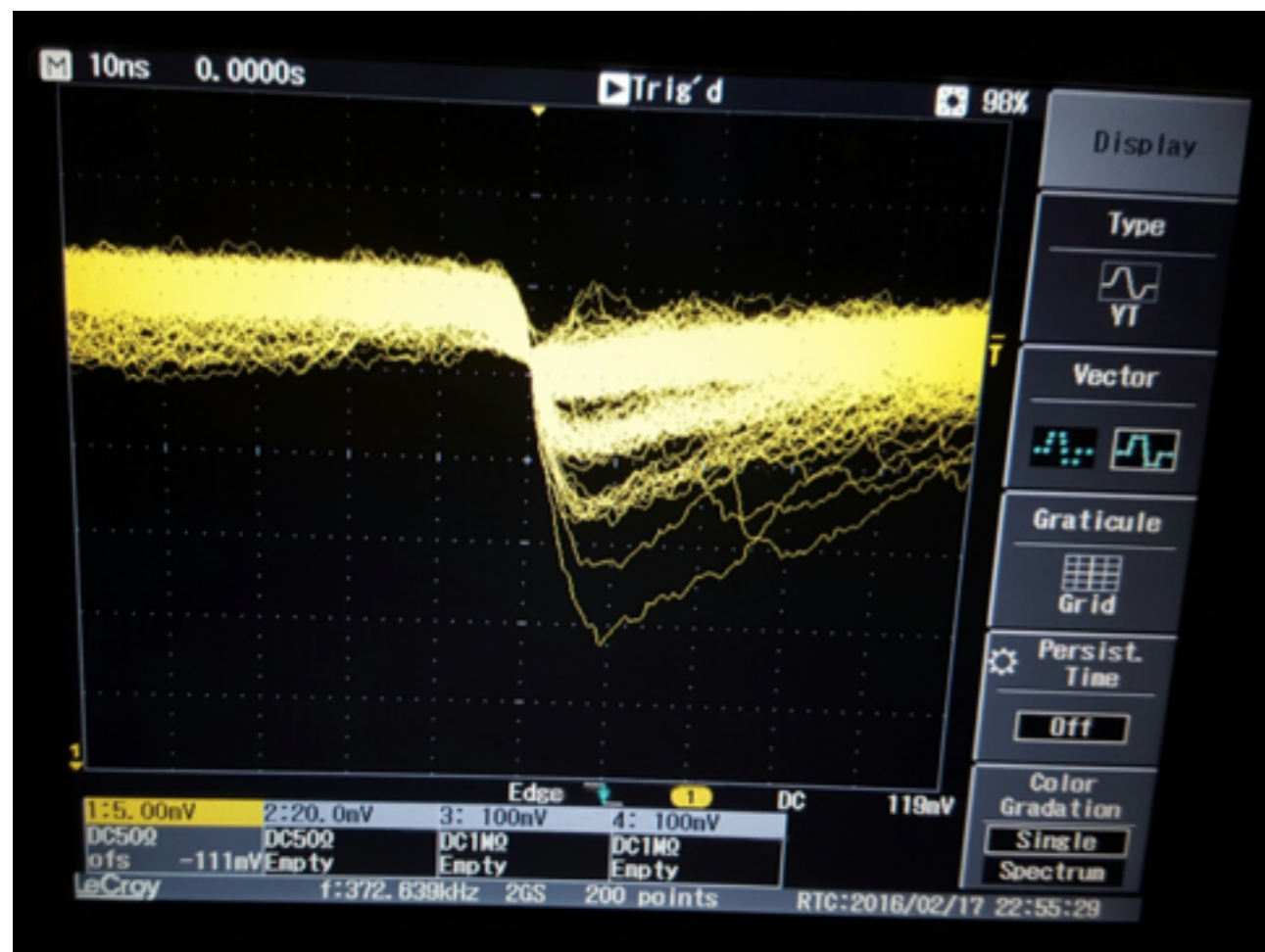

Dark current

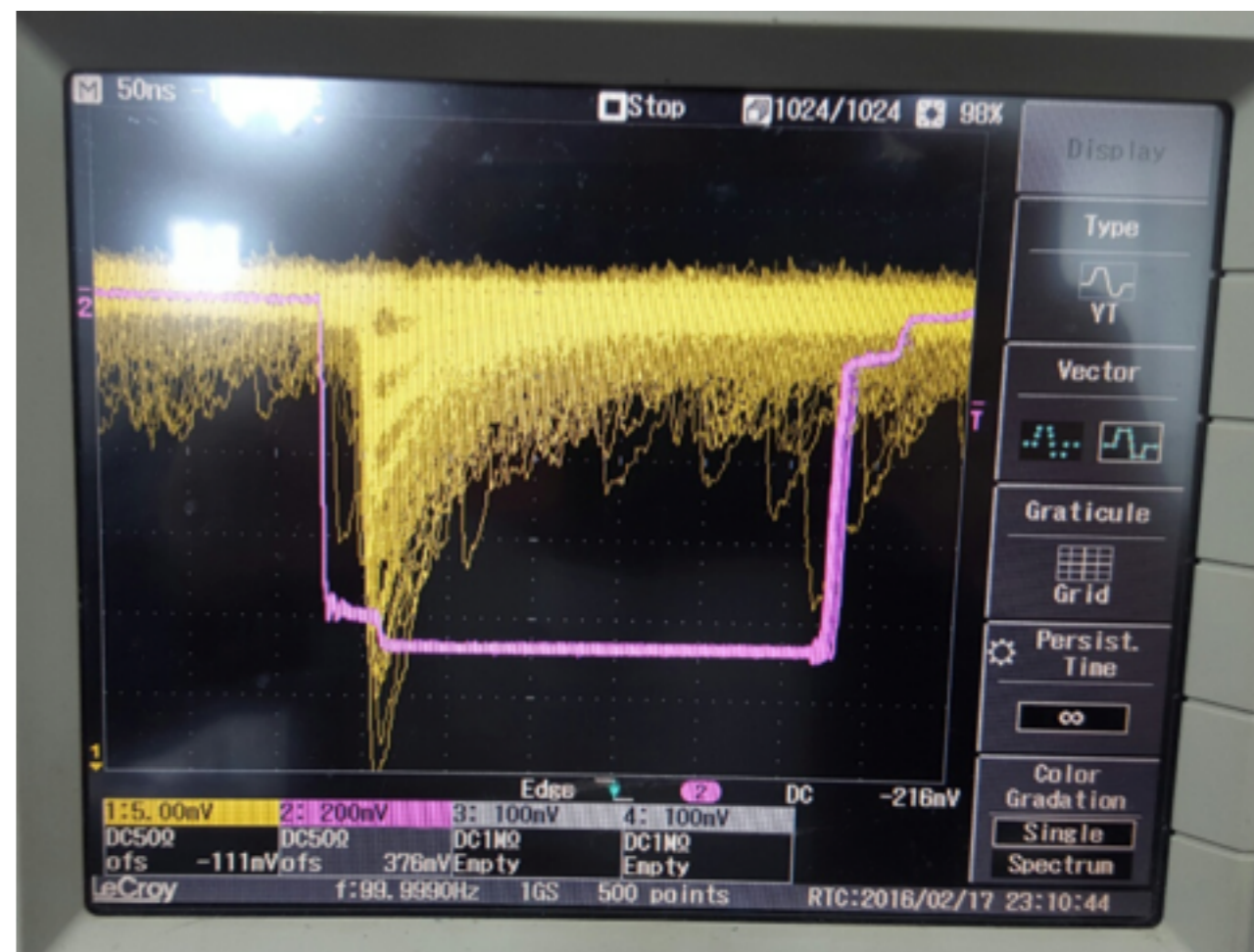

LED signals



# Results

## MPPC Signal Distribution

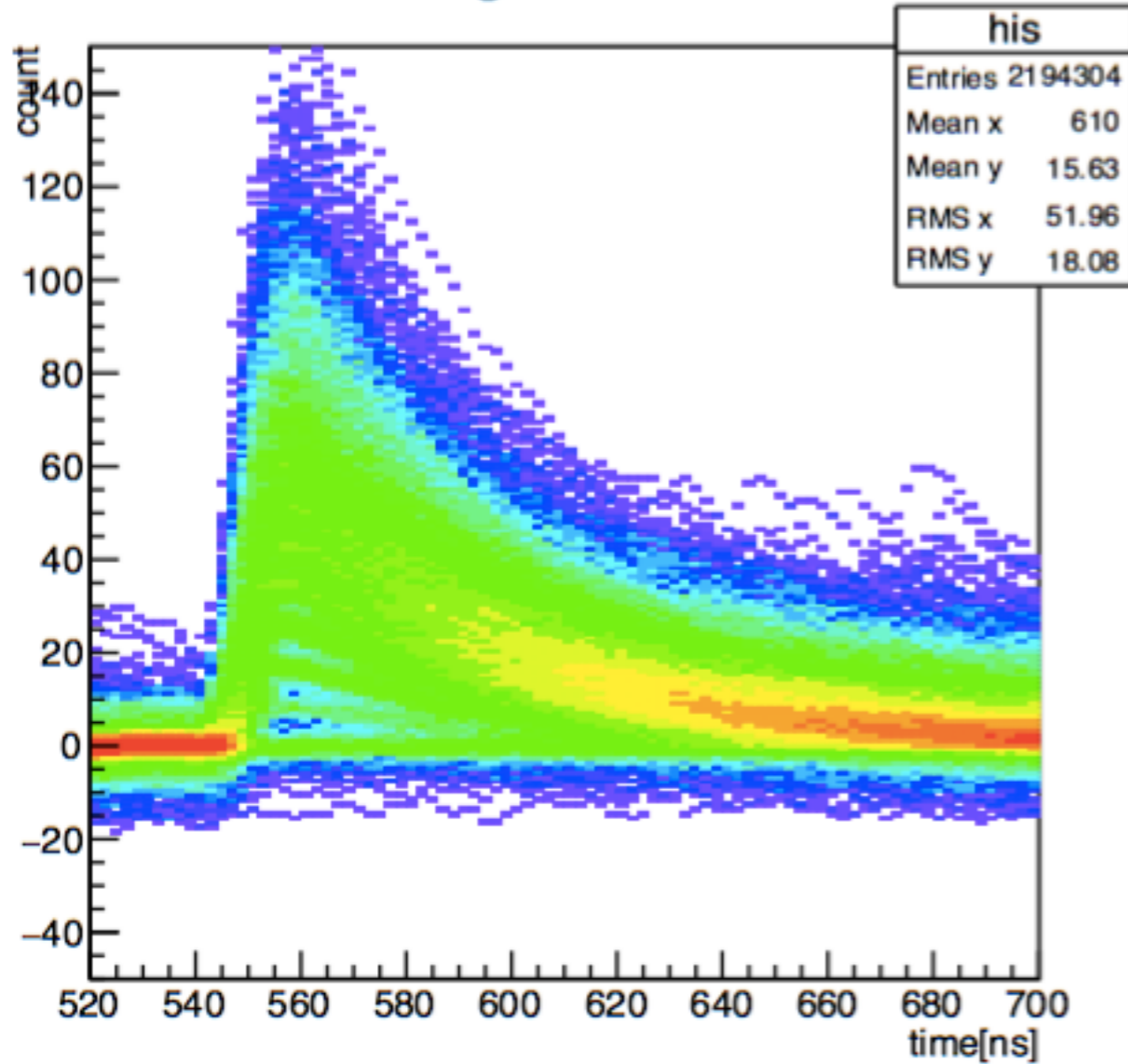

## MPPC Signal Height

